

# WAC LIGHTING

## Dune 826

### Low Voltage Track Luminaire

| System Type & Voltage     | Model & Wattage | Finish            |
|---------------------------|-----------------|-------------------|
| -HHT H Track - 120 VAC    | 826 50W         | BK Black          |
| -JHT J/J2 Track - 120 VAC | 826L 75W        | BN Brushed Nickel |
| -LHT L Track - 120 VAC    |                 | WT White          |

Example: **HHT-826-BK**

#### DESCRIPTION

Dune is a unique spot light with solid construction and simple aiming features for easy adjustments. Low Voltage track fixture offered in a wide variety of styles and finishes for a multitude of lighting applications in residential, retail, commercial and hospitality environments. Available in H, J/J2, and L style track configurations. Built-in transformer has a 1W minimum load and can be installed with an LED lamp.

#### FEATURES

- Available with LED lamp option
- 350° horizontal rotation and 90° vertical tilt
- Loop back aiming arm for simple adjustments
- Screw on lens cap
- Clear lens included
- Transformer concealed within the fixture
- 5 year warranty

#### SPECIFICATIONS

|                        |                                                                                                                                                                                                                                                                        |
|------------------------|------------------------------------------------------------------------------------------------------------------------------------------------------------------------------------------------------------------------------------------------------------------------|
| <b>Construction:</b>   | Die-cast aluminum track head with polycarbonate transformer case and track adapter. Bi-pin ceramic socket for MR16 lamp., Die-cast aluminum fixture with polycarbonate track adapter. Heat resistant rubber grips over rear socket assemblies. Ceramic bi-pin sockets. |
| <b>Power:</b>          | 75W, 50W                                                                                                                                                                                                                                                               |
| <b>Input:</b>          | 120 VAC, 50/60Hz                                                                                                                                                                                                                                                       |
| <b>Dimming:</b>        | ELV: 100-15%                                                                                                                                                                                                                                                           |
| <b>Light Source:</b>   | MR16 ( Order separately )                                                                                                                                                                                                                                              |
| <b>Finish:</b>         | Body Electrostatically powder Coated White, Electroplated Brushed Nickel, Body Electrostatically powder Coated Black                                                                                                                                                   |
| <b>Operating Temp:</b> | -4°F to 104°F (-20°C to 40°C)                                                                                                                                                                                                                                          |
| <b>Standards:</b>      | UL, cUL, Dry Location Listed                                                                                                                                                                                                                                           |

Fixture Type: \_\_\_\_\_  
 Catalog Number: \_\_\_\_\_  
 Project: \_\_\_\_\_  
 Location: \_\_\_\_\_



#### FINISHES

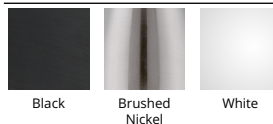

#### LINE DRAWING

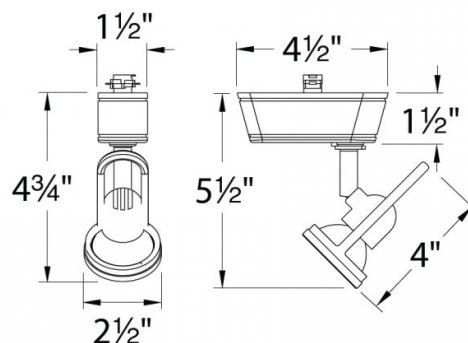

Fixture Type: \_\_\_\_\_

Catalog Number: \_\_\_\_\_







Project: \_\_\_\_\_

Location: \_\_\_\_\_

## Dune 826

Low Voltage Track Luminaire

### ACCESSORIES

|                                                                                     | <i>Model</i>                                                                         | <i>Description</i>                                                                       | <i>Finish</i>                                             |
|-------------------------------------------------------------------------------------|--------------------------------------------------------------------------------------|------------------------------------------------------------------------------------------|-----------------------------------------------------------|
|    | <b>LENS-16-AMB</b><br><b>LENS-16-BLU</b><br><b>LENS-16-GRN</b><br><b>LENS-16-RED</b> | <i>Colored Lens</i><br><i>Colored Lens</i><br><i>Colored Lens</i><br><i>Colored Lens</i> | <i>Amber</i><br><i>Blue</i><br><i>Green</i><br><i>Red</i> |
|    | <b>LENS-16-FR</b>                                                                    | <i>Clear/Frosted Lens</i>                                                                | <i>Frosted</i>                                            |
|    | <b>LENS-16-SPR</b>                                                                   | <i>Spread Lens</i>                                                                       | <i>Spread Lens</i>                                        |
|  | <b>LENS-16-UVF</b>                                                                   | <i>UV Filter lens</i>                                                                    | <i>Clear</i>                                              |
|  | <b>LENS-16-BEL</b>                                                                   | <i>Beam Elongating Lens</i>                                                              | <i>Beam Elongating</i>                                    |
|  | <b>LENS-16-HCL</b>                                                                   | <i>Honeycomb Louver</i>                                                                  | <i>Black</i>                                              |