

2170 - Hedron

hedron™
assembly instructions

SONNEMAN®
A WAY OF LIGHT

©2019 SONNEMAN - A Way of Light

Hedron™ Product Information and Warnings

Important

- **Always disconnect the power before installing or replacing Luminaires and before cleaning or other maintenance.**
- **Consult a qualified, licensed electrician to ensure correct branch circuit conductor.**
Consulter un électricien qualifié pour vous assurer que les conducteurs de la dérivation sont adéquats.
- Please read all included assembly instructions and warnings carefully before installation. Contact Customer Service if you have any questions or concerns. Before installation, please confirm that the fixture is compatible with your supply voltage and dimming system, if present.
- LEDs are highly sensitive electronic devices, and must be treated with care. Do not open any factory sealed compartments, and avoid touching the LEDs with your hands or any object.
- Although all our fixtures are equipped with protective devices, LED electronic systems are vulnerable to power surges and supply variations. Do not install LED fixtures on the same circuit as any motors, appliances, or HVAC systems.
- Remote LED Driver installation must be done by a licensed electrician and in accordance with local building and electrical codes. Remote installations should be in an accessible location, as close to the fixture as possible. The appropriate wire gauge must be used to limit the voltage drop to avoid overloading the LED Driver.
- Any mounting hardware is provided for your convenience and should be used with discretion. Always use the appropriate hardware for the mounting surface.
- This fixture is dimmable with Electronic Low Voltage (Trailing-Edge) type and Incandescent (Leading-Edge) type dimmers.
- Hedron™ must be installed in dry locations ONLY.

December 16, 2019

Welcome to Hedron™

A Hedron configuration is built from LED hubs, connecting arms, and cable ceiling hangers. Illumination radiates through either the white optical acrylic lenses, or sparkles with refracted light through micro-faceted clear acrylic crystal lenses. Each hub is a complete LED light engine, using an array of LEDs with driver circuitry on each of the two faces of the hub. The connecting arms form a structural and electrical connection between the hubs, and are easily assembled by inserting the arm into the hub and are secured in place by a retaining set screw. The configuration is supported by cable ceiling hangers that slide onto an arm and lock into place as needed, and is powered by a special power feed hub connected to the ceiling power feed.

WHAT COMES IN THE BOX

Ceiling Hanger/Hanger Clips - Contains the cable ceiling hanger and stay clips as well as a parts bag necessary for configuration assembly.

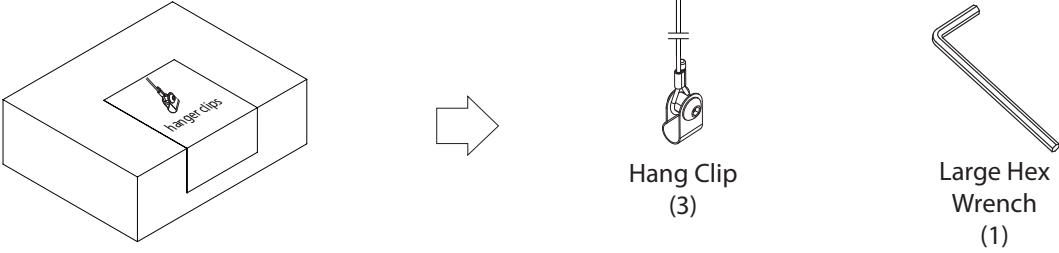

Power Feed - Contains the power feed for attaching the configuration to the outlet box and connecting to the power supply. Also includes a parts bag necessary for installation.

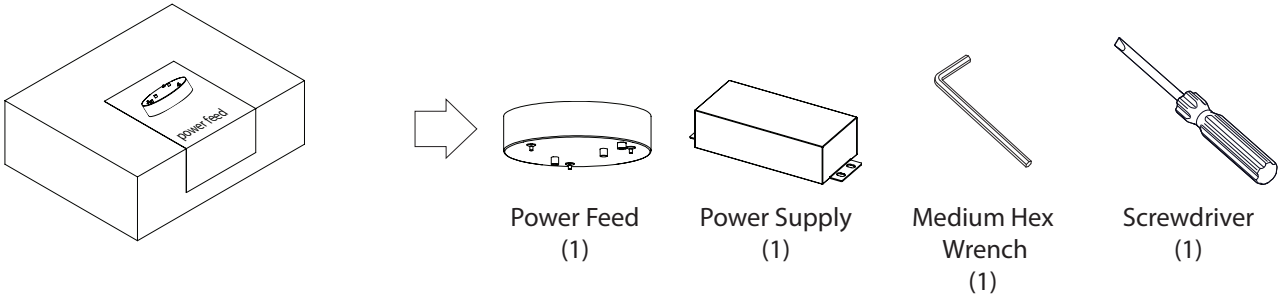

Hubs - Contains the LED hubs identified with a chart inside the box cover.

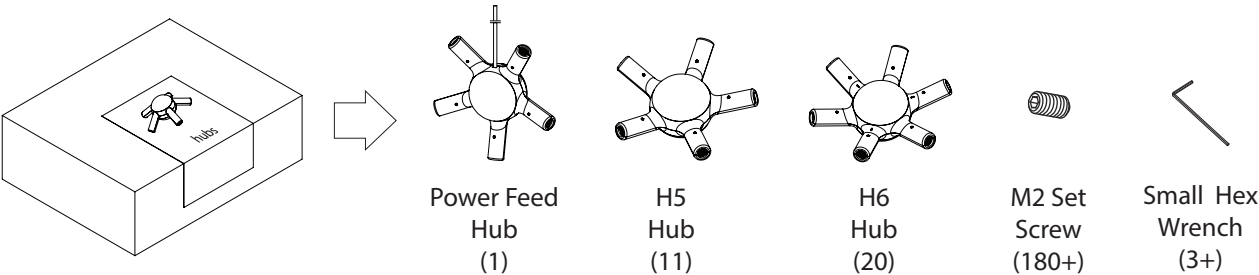

C1 (Short) Arms - Multiple boxes

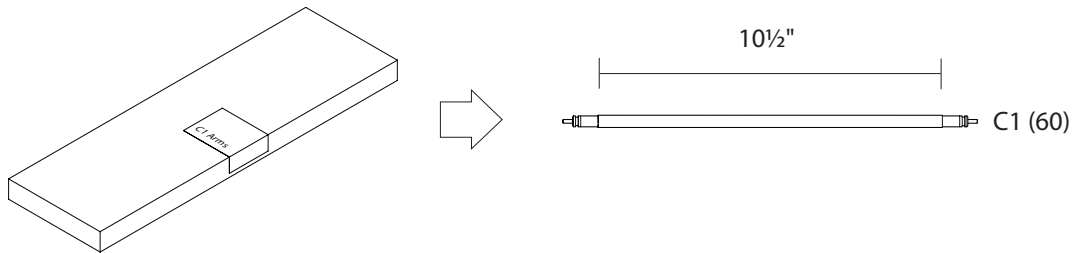

C2 (Long) Arms - Multiple boxes

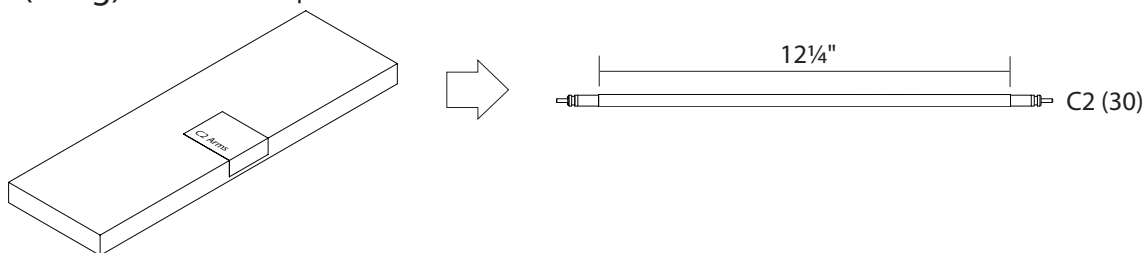

KEY	
	6-Way Hub (H6)
	5-Way Hub (H5)
	C1 - 10 1/2"
	C2 - 12 1/4"

December 16, 2019

Step 1

- a. Attach all C1 arms to an H5 Hub, as shown in Fig. 2.
Install each Arm into an LED Hub by fully inserting the Arm into a Neck on the Hub (Fig. 1). After each Arm is connected to the Hub, install the M2 Set Screw into the Neck of the Hub, using the Small Hex Wrench provided, and tighten until it comes in contact with the plastic cap on the Arm. **DO NOT OVERTIGHTEN THE SCREWS.**
- b. Repeat for all H5 Hubs, including the Powered Hub. Set aside the Powered Hub with Arms for Step 9.
- c. Fig. 3 shows this step in the context of the assembly as a whole.

Arm Key	
C1	10½" (60)
Hub Key	
H5	11x
PWR	1x

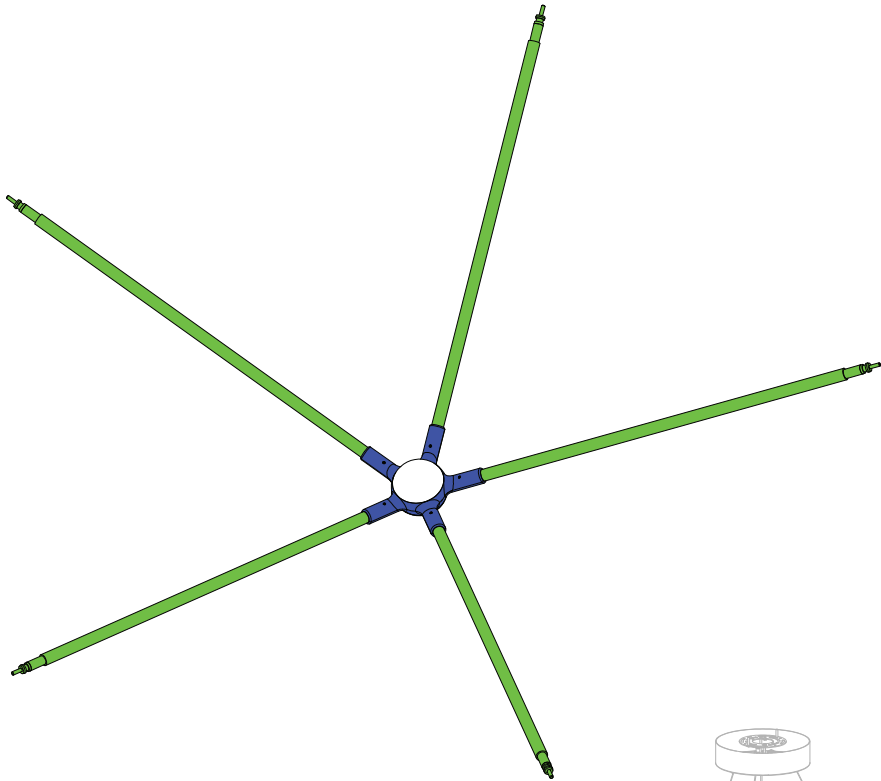

Fig. 2

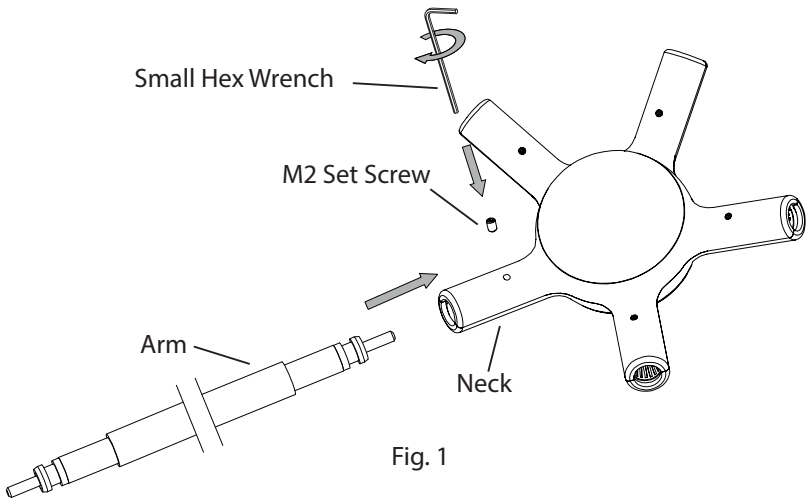

Fig. 1

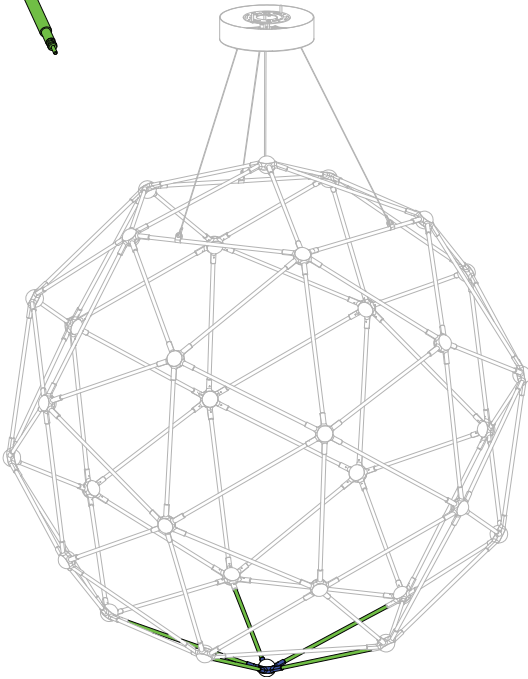

Fig. 3

Step 2

- Take one of the completed H5 Hubs and attach H6 Hubs onto the end of each arm using one of the necks without a notch.
- Connect the H6 Hubs using C2 Arms as shown in Fig. 4.

Note: Make sure the notches on the H6 Hubs are facing each other and not the H5 Hub (see Detailed View).

- Fig. 5 shows this step in the context of the assembly as a whole.

Arm Length Key	
C2	12¼" (5)
Hub Key	
H6	5x

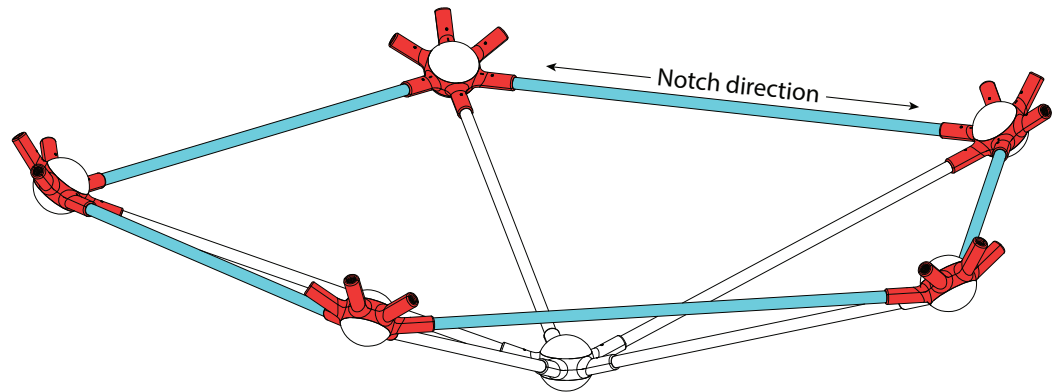

Fig. 4

IMPORTANT:

Be sure to install all M2 Set Screws to secure the Arms to the Hubs, as shown on page 5.

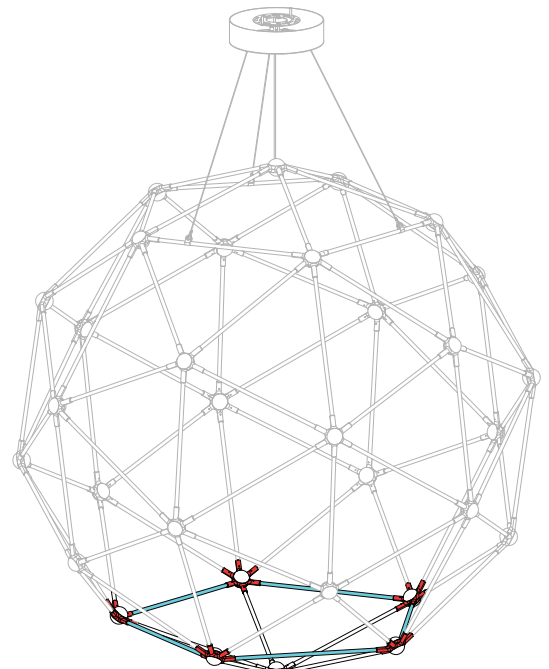
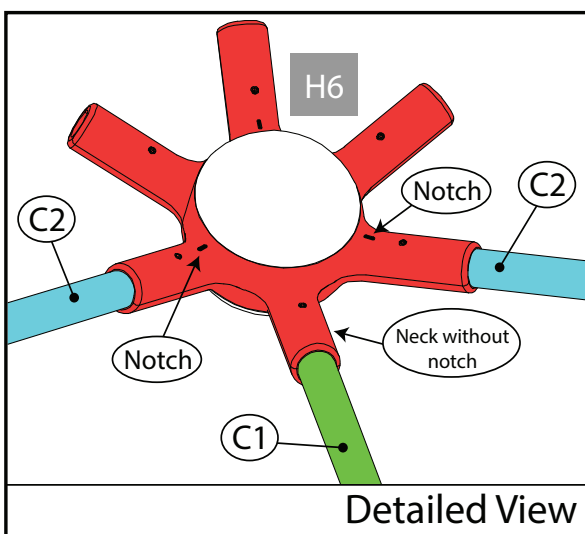
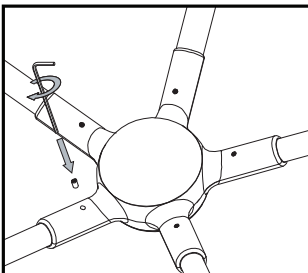

Fig. 5

December 16, 2019

Step 3

- a. Attach five of the completed H5 Hub clusters to H6 Hubs as shown in Fig. 6.
- b. Fig. 7 shows this step in the context of the assembly as a whole.

Arm Key	
C1	10½" (25)
Hub Key	
H5	5x

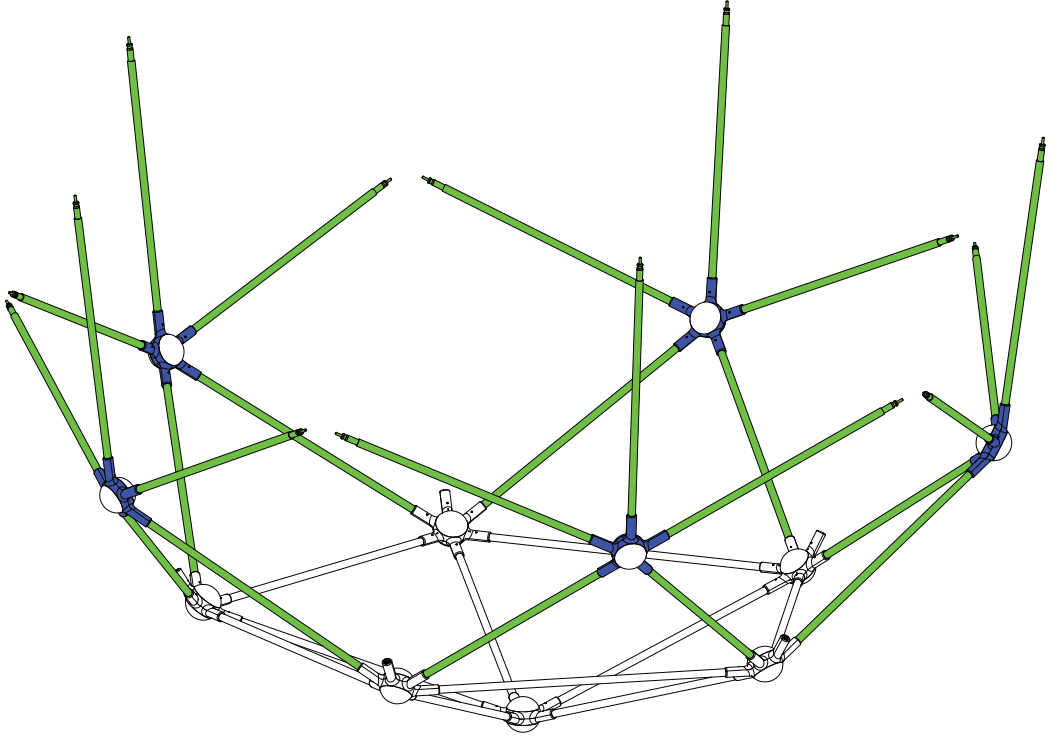

Fig. 6

IMPORTANT:
Be sure to install all M2 Set Screws to secure the Arms to the Hubs, as shown on page 5.

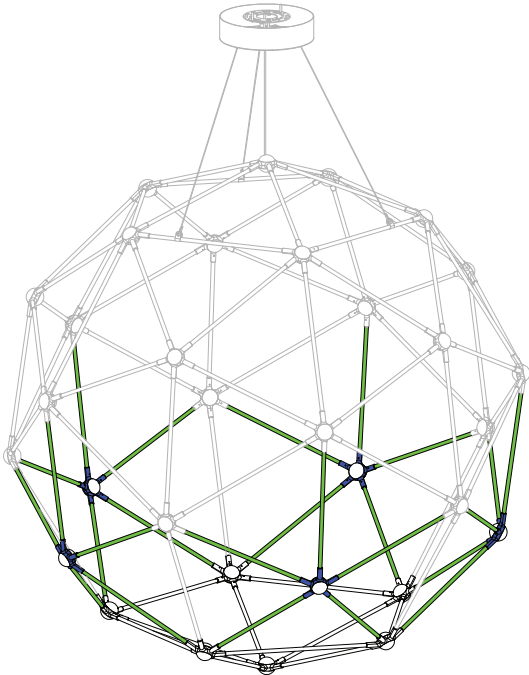
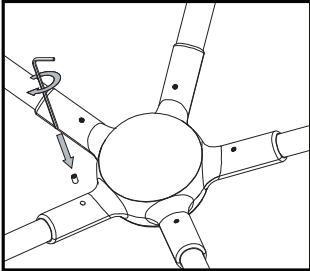

Fig. 7

Step 4

- a. Attach C2 Arms to remaining open necks in the H6 Hubs.
- b. Attach H6 Hubs to C2 Arms and adjacent C1 Arms, as shown in Fig. 8.

Note: Make sure the notches on the H6 Hubs are facing each other and not the H5 Hub (see Detailed View).

- c. Fig. 9 shows this step in the context of the assembly as a whole.

Arm Length Key	
C2	12¼" (5)
Hub Key	
H6	5x

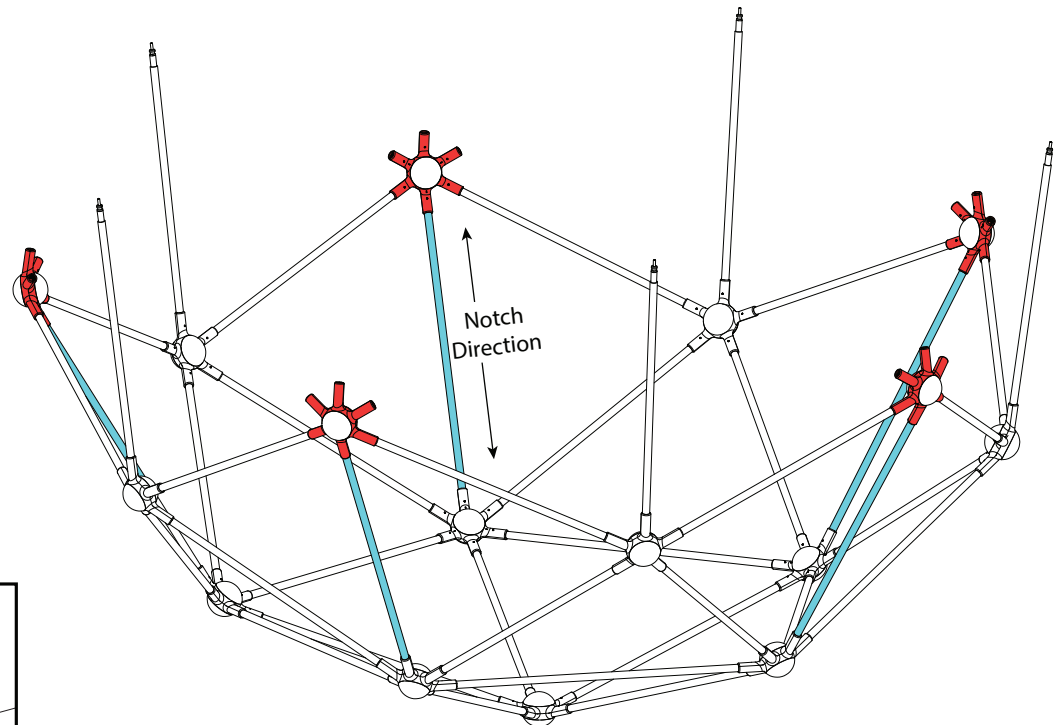

Fig. 8

IMPORTANT:

Be sure to install all M2 Set Screws to secure the Arms to the Hubs, as shown on page 5.

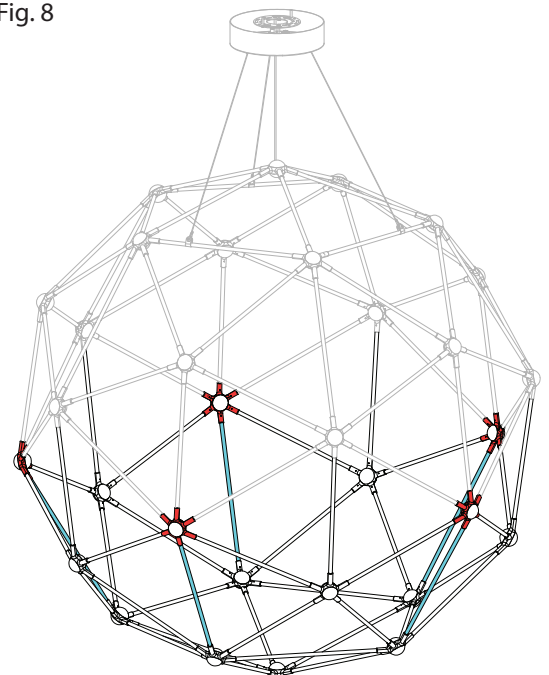
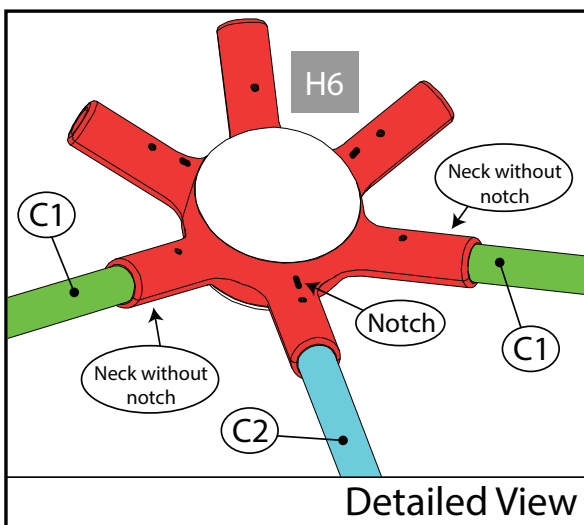
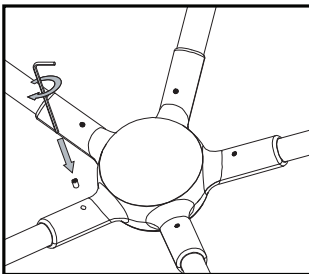

Fig. 9

December 16, 2019

Step 5

- a. Attach H6 Hubs to the remaining open C1 Arms using one of the necks without a notch.
- b. Connect the H6 Hubs to adjacent H6 Hubs with C2 Arms, as shown in Fig. 10.

Note: Make sure the notches on the H6 Hubs are facing each other and not the H5 Hub (see Detailed View).

- c. Fig. 11 shows this step in the context of the assembly as a whole.

Arm Length Key	
C2	12¼" (10)
Hub Key	
H6	5x

IMPORTANT:
Be sure to install all M2 Set Screws to secure the Arms to the Hubs, as shown on page 5.

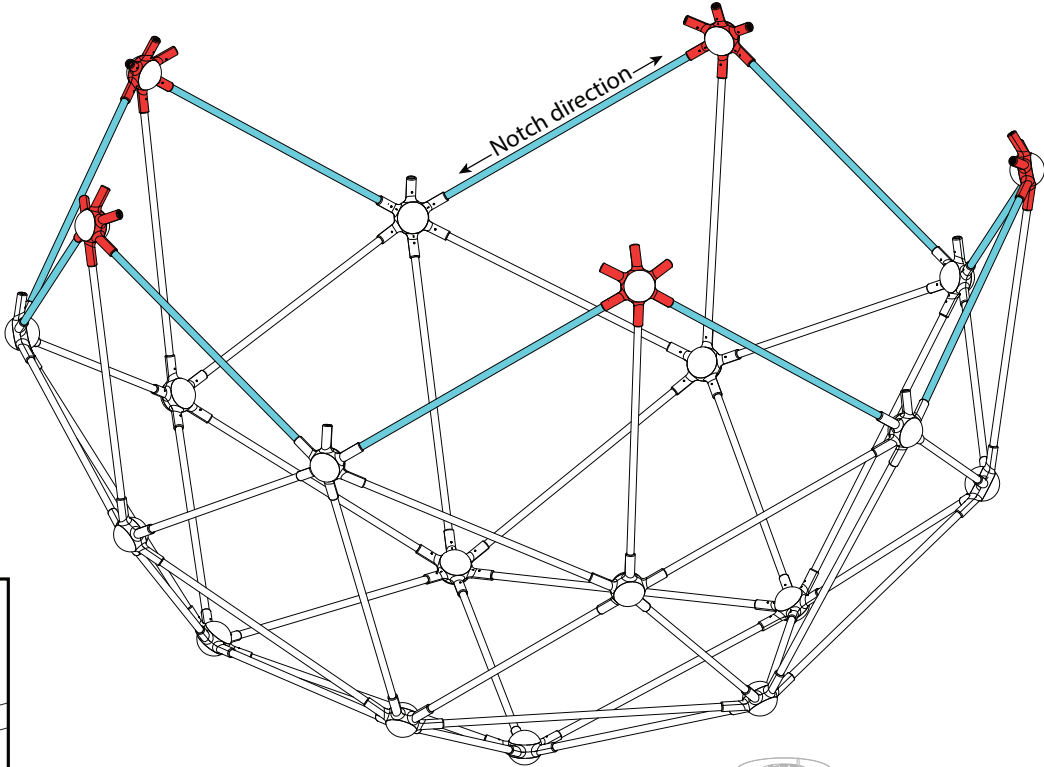
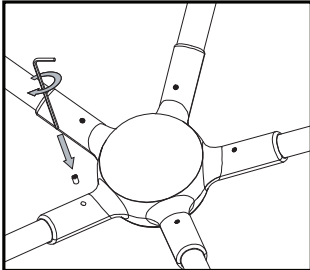
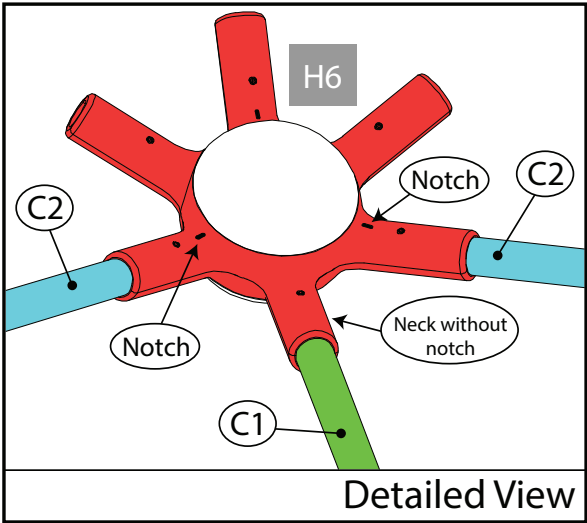

Fig. 10



Detailed View

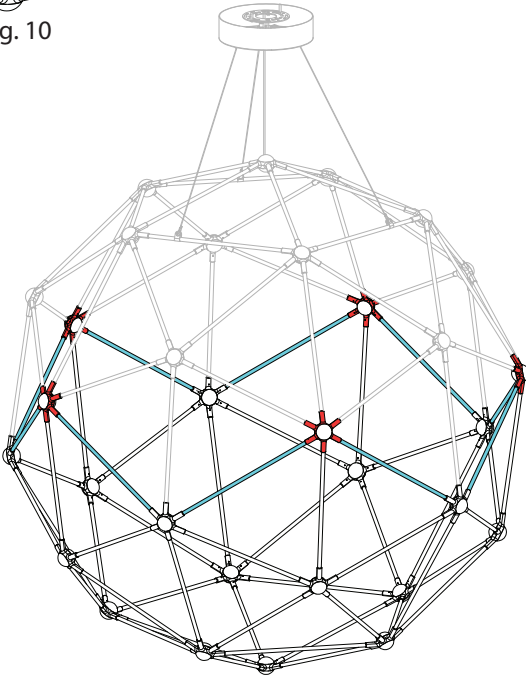

Fig. 11

Step 6

- Attach five of the completed H5 Hub clusters to H6 Hubs as shown in Fig. 12.
- Fig. 13 shows this step in the context of the assembly as a whole.

Arm Key	
C1	10½" (25)
Hub Key	
H5	5x

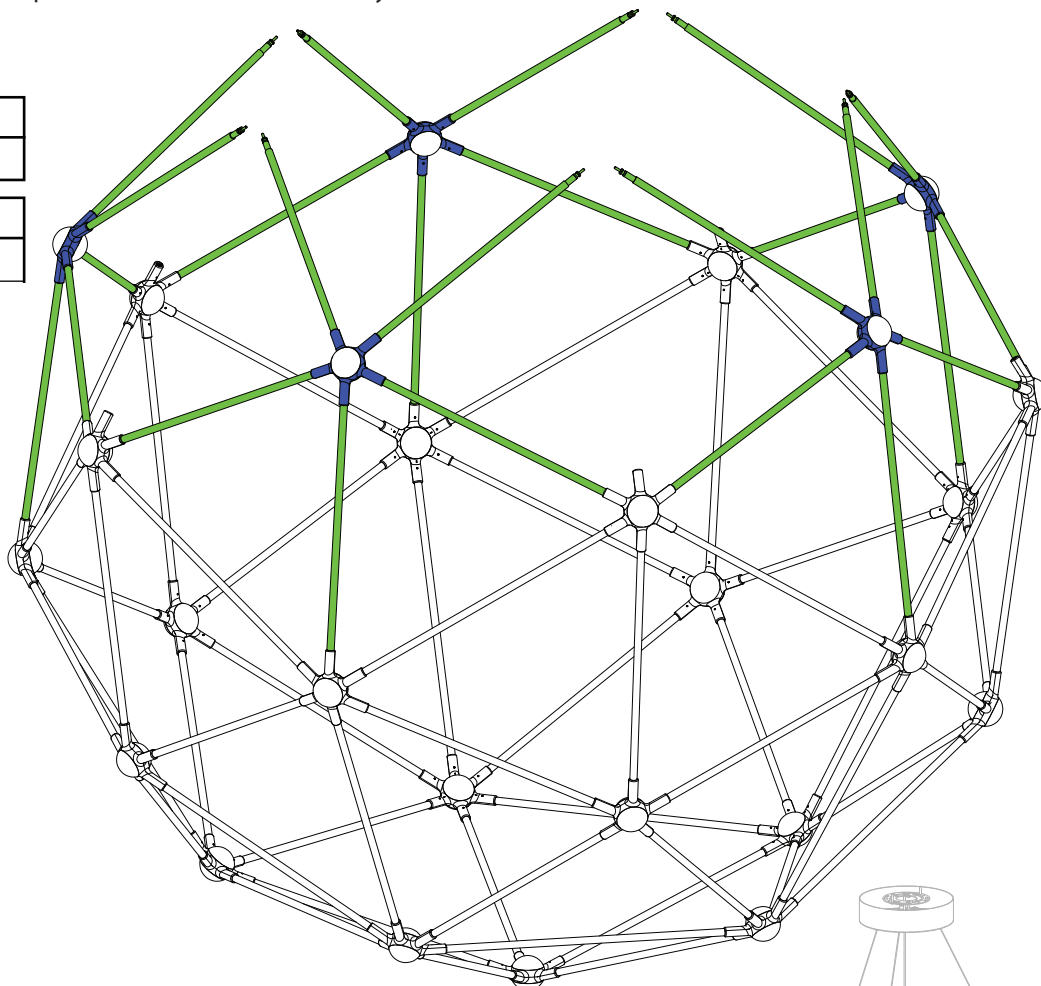

Fig. 12

IMPORTANT:

Be sure to install all M2 Set Screws to secure the Arms to the Hubs, as shown on page 5.

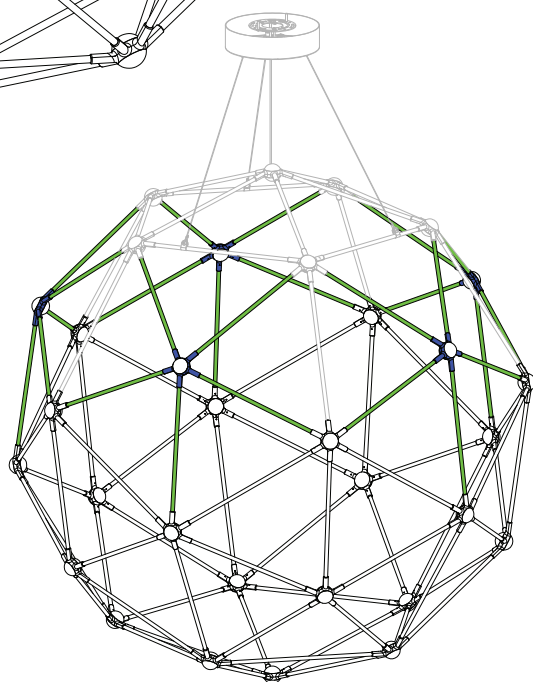
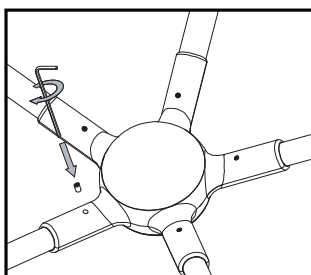

Fig. 13

December 16, 2019

Step 7

- a. Attach C2 Arms to remaining open necks in the H6 Hubs.
- b. Attach H6 Hubs to C2 Arms and adjacent C1 Arms, as shown in Fig. 14.

Note: Make sure the notches on the H6 Hubs are facing each other and not the H5 Hub (see Detailed View).

- c. Fig. 15 shows this step in the context of the assembly as a whole.

Arm Length Key	
C2	12¼" (5)
Hub Key	
H6	5x

IMPORTANT:
Be sure to install all M2 Set Screws to secure the Arms to the Hubs, as shown on page 5.

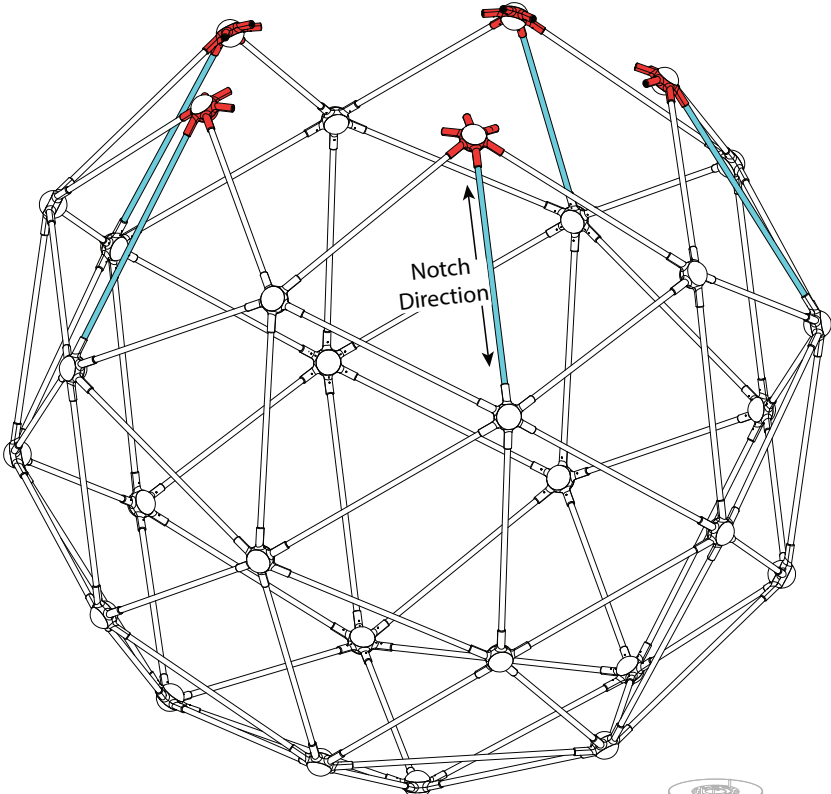
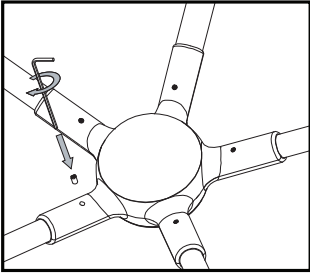
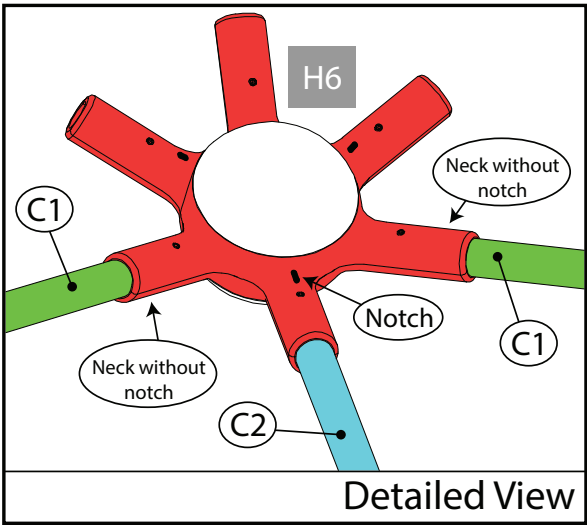

Fig. 14



Detailed View

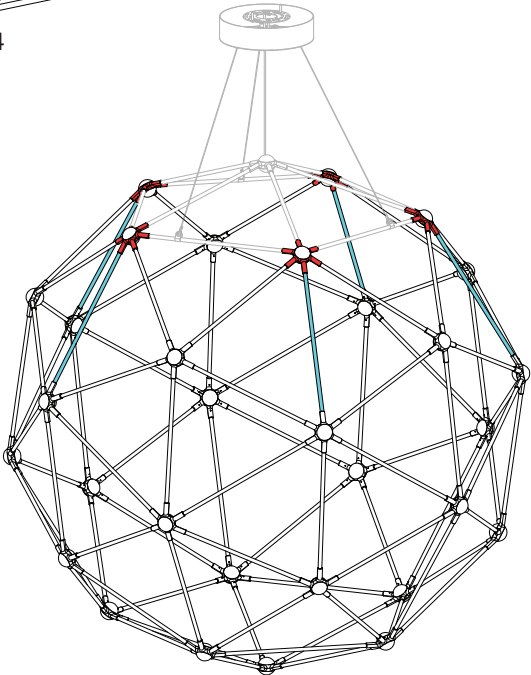

Fig. 15

Step 8

- Slide Hanger Clips onto three of the remaining C2 Arms, then use the provided large Hex Wrench to tighten the Screw, as seen in Fig. 19.
- Connect the open H6 hubs using the remaining C2 Arms as shown in Fig. 16.
Note: Hanger Clips must be positioned as shown in Fig. 18.
- Fig. 17 shows this step in the context of the assembly as a whole.

Arm Length Key

C2	12 $\frac{1}{4}$ " (5)
----	------------------------

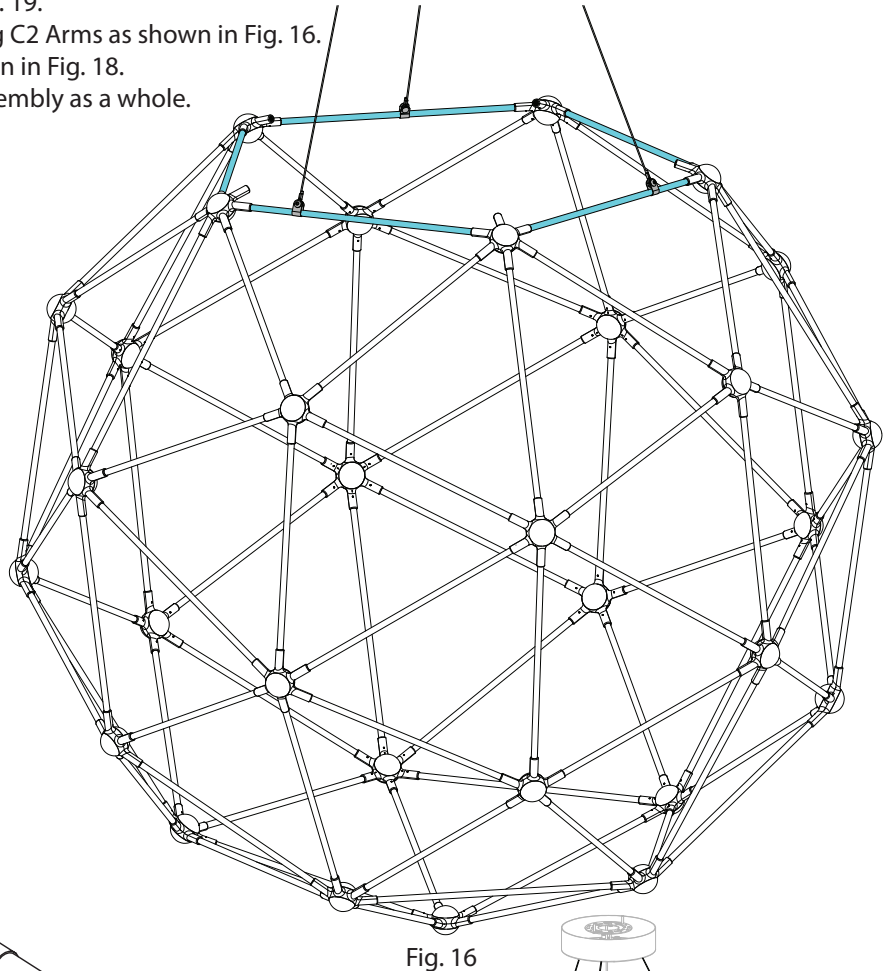
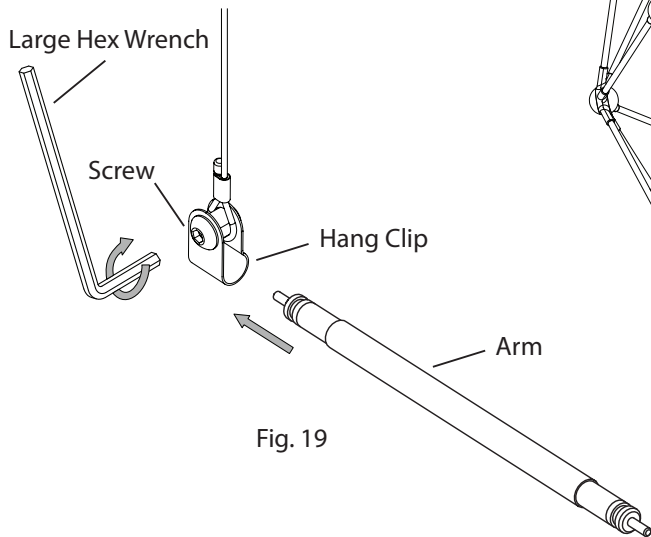

IMPORTANT:

Be sure to install all M2 Set Screws to secure the Arms to the Hubs, as shown on page 5.

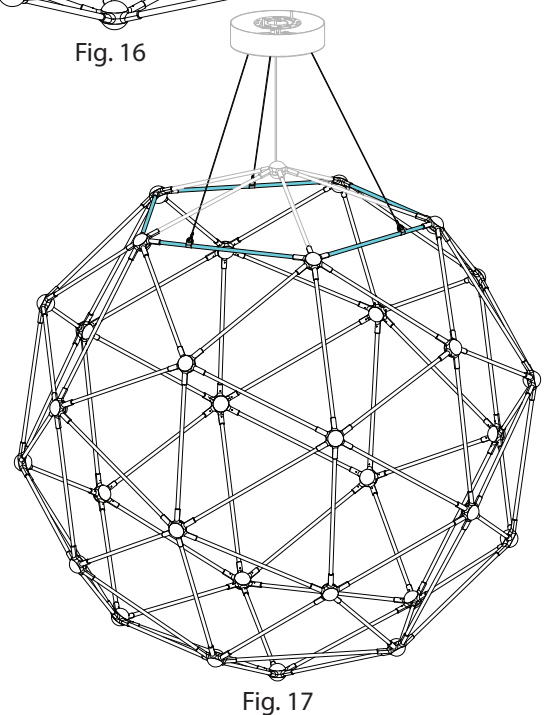
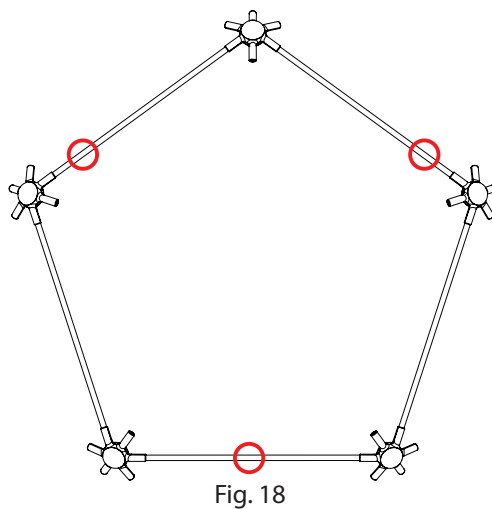
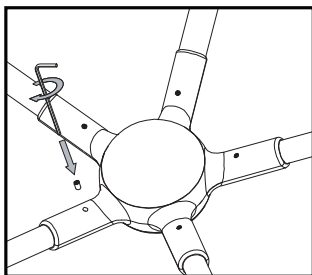

December 16, 2019

Step 9

- a. Feed the Cord on the Power Feed Hub through the Bushing on the Power Feed. Adjust the cord length to the desired height, and secure with the Slotted Set Screw using the provided Screwdriver. Reserve excess Cord in the Power Feed.
The Power Feed Hub must be a minimum of 12" below the canopy.
- b. Attach the Mounting Plate to the Outlet Box using the two (2) Outlet Box Screws.
- c. Make appropriate electrical connections using wire nuts:
If shortening the cord is necessary, see Appendix A.
 - i. Connect the LED driver's live wire (black) to the live supply wire.
 - ii. Connect the LED driver's neutral wire (white) to the neutral supply wire.
 - iii. Connect the fixture's ground wire (green or uncoated) to the ground outlet box wire. If no ground is present in outlet box, connect fixture's ground wire to the Mounting Plate using the green screw (included).
 - iv. Connect the positive (red) low voltage wire from the LED driver to the inner stranded conductor of the Power Feed Hub Cord.
 - v. Connect the negative (black) low voltage wire from the LED driver to the outer braided conductor of the Power Feed Hub Cord.
 - vi. Carefully place the connections in the Canopy.
- d. Attach the Power Feed to the Mounting Plate and secure with finials.
- e. Lift the fixture using the Hang Clip Cables and attach to Cable Grippers on the Power Feed by inserting the end of the Hang Clip Cable into the Cable Gripper to the desired height. To shorten the cable, push the cable up and it will be locked automatically. To lengthen the cable, lift up on the cable and push up on the gripper. While keeping the gripper depressed, lower the cable to the desired height and release the gripper to set.

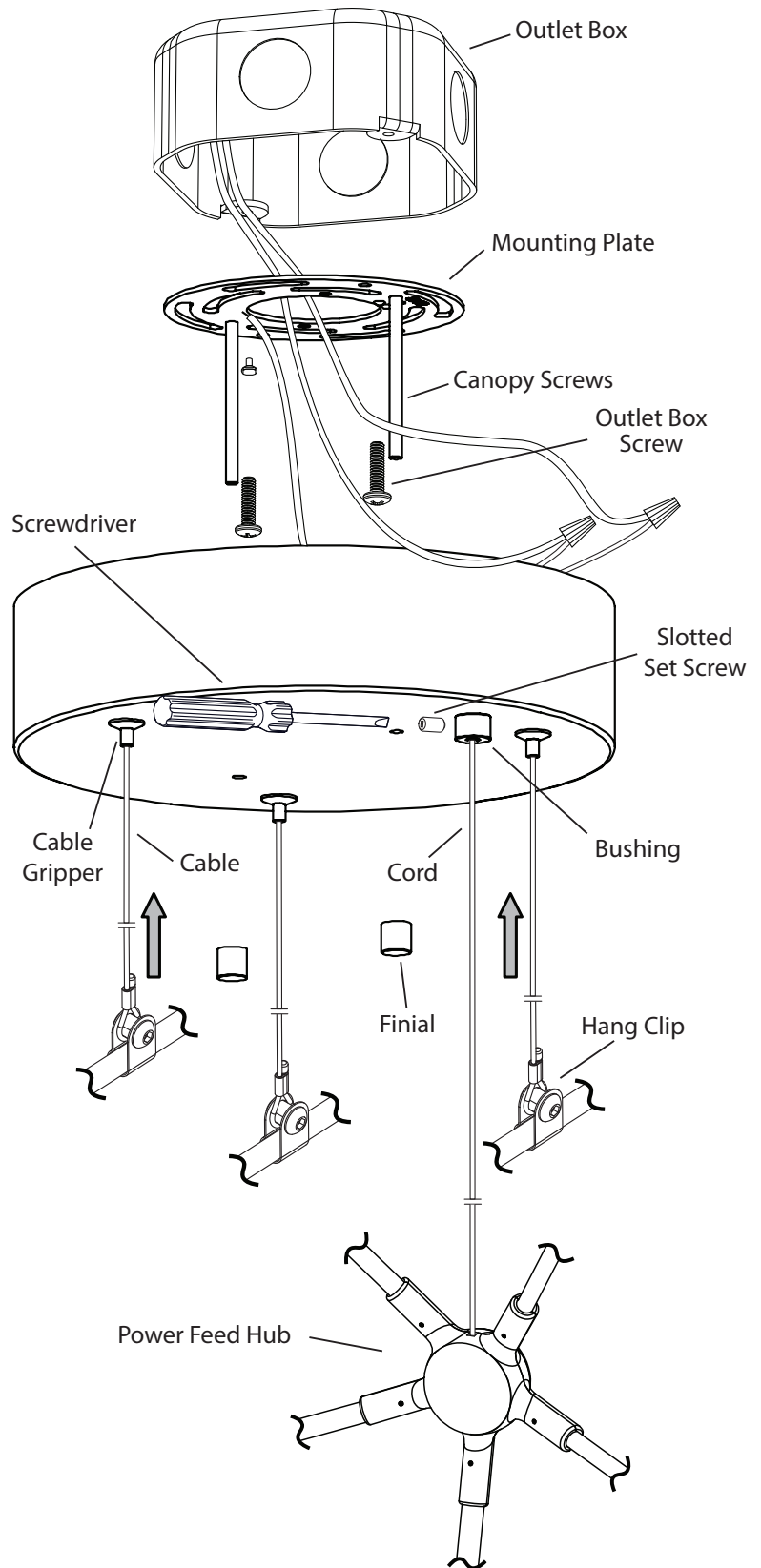

Fig. 20

Step 10

- a. Connect the Power Feed Hub cluster as seen in Fig. 21, making sure not to tangle the cords and cable.
- b. Adjust cables until fixture is level and cord loses its slack but is not taut.
- c. Restore power to Outlet Box.

Arm Key	
C1	10½" (5)
Hub Key	
H5	1x

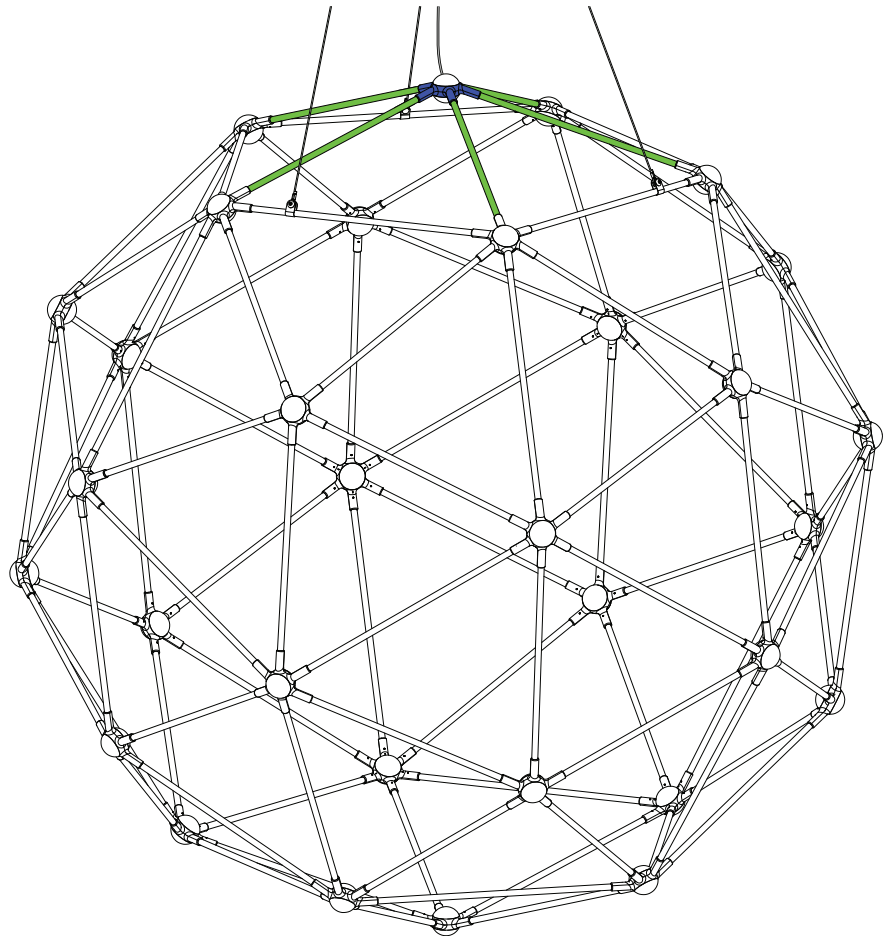
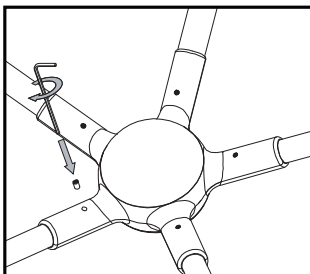

Fig. 21

IMPORTANT:

Be sure to install all M2 Set Screws to secure the Arms to the Hubs, as shown on page 5.



December 16, 2019

COMPLETED ASSEMBLY

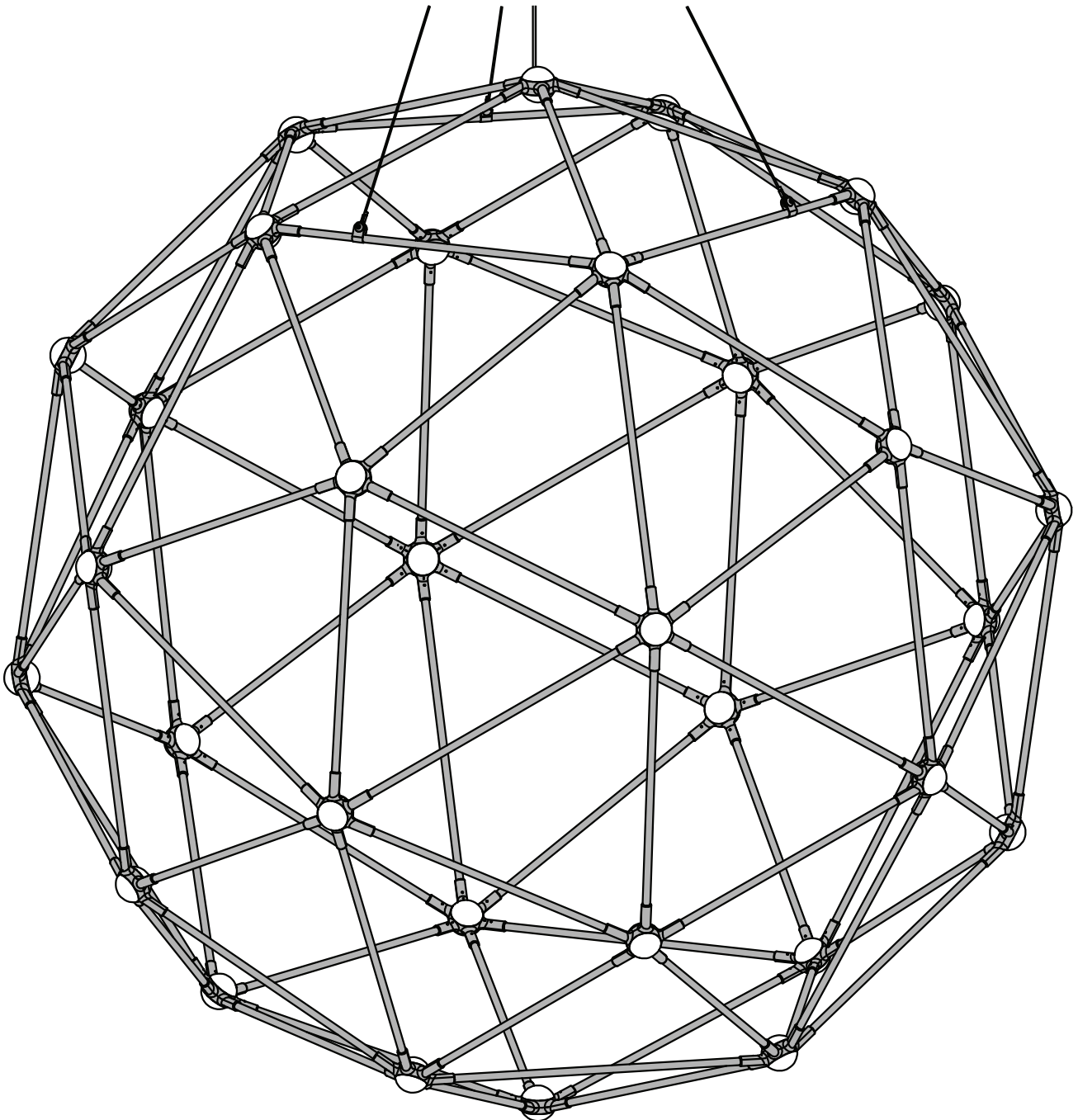

December 16, 2019

Coax Splicing

Assembly Instructions

INSTRUCTIONS D'INSTALLATION

FAILURE TO FOLLOW THESE INSTRUCTIONS WILL VOID THE WARRANTY

Coaxial Power Cord:

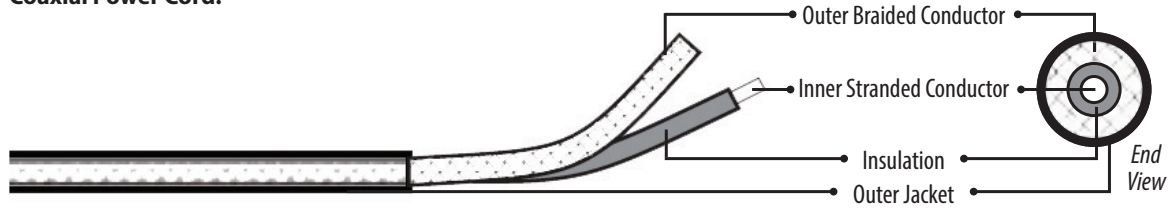

If field-cutting is required, please follow the below instructions:

1. Make a 1" slice along the length of the cord's outer jacket (Fig. 1). **CAUTION: Do not cut through the outer braided conductor.**
2. Carefully strip the outer jacket of the cord and keep the outer braided conductors intact (Fig. 1).
3. Slide the outer braided conductor back to create a bulge and reveal the inner stranded conductor (Fig. 2).
4. Bend the cord to create an opening through the bunched-up portion of outer braided conductor, then pull out the inner stranded conductor (Fig. 3)
5. Twist together the outer braided conductor to form the negative wire of the fixture, then strip 5/8" off the end of the inner stranded conductor to form the positive wire of the fixture (Fig. 4).
6. Re-splice all power cords.

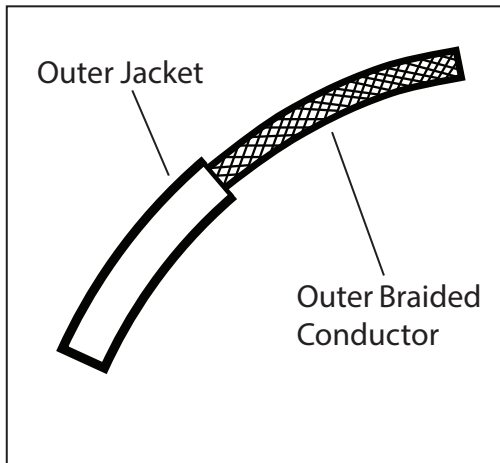

Fig. 1

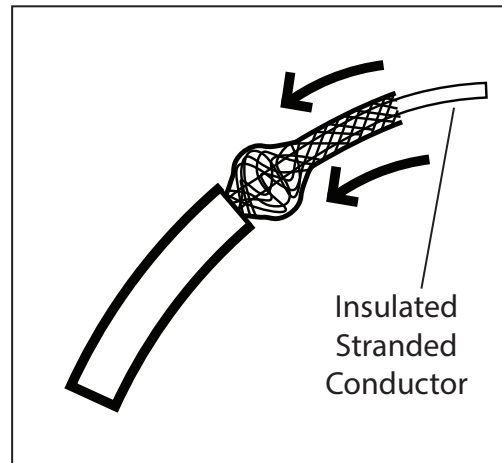

Fig. 2

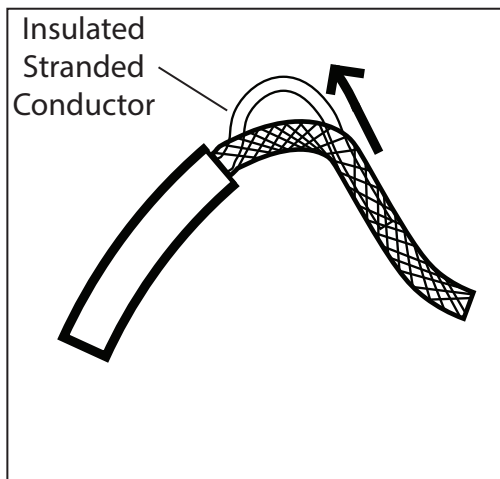

Fig. 3

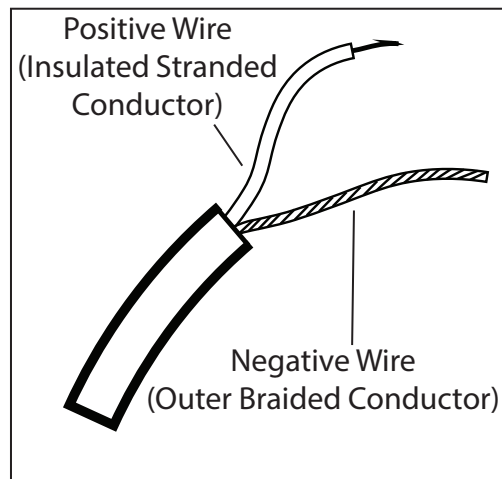

Fig. 4