

Project:

Sultana 12-Light Round Chandelier Spec Sheet

SKU: 4164.38

Sultana celebrates the luxuriously crafted, sculptural LED illuminated effect of hand-blown seeded crystal glass in dialogue with solid brass or polished chrome. Sultana Chandeliers are available in 9-light, 12-light, and 24-light configurations, or can be hung as single pendants. This elegant fixture creates a statement in a dining room, entryway, lobby, or hospitality setting. Sultana [Pendants](#) and Chandeliers are available in a Satin Brass or Polished Chrome fixture. The Satin Brass and Polished Chrome fixtures feature a white canopy.

Learn more: <https://sonnemanlight.com/sultana-round-chandelier>

Type #:

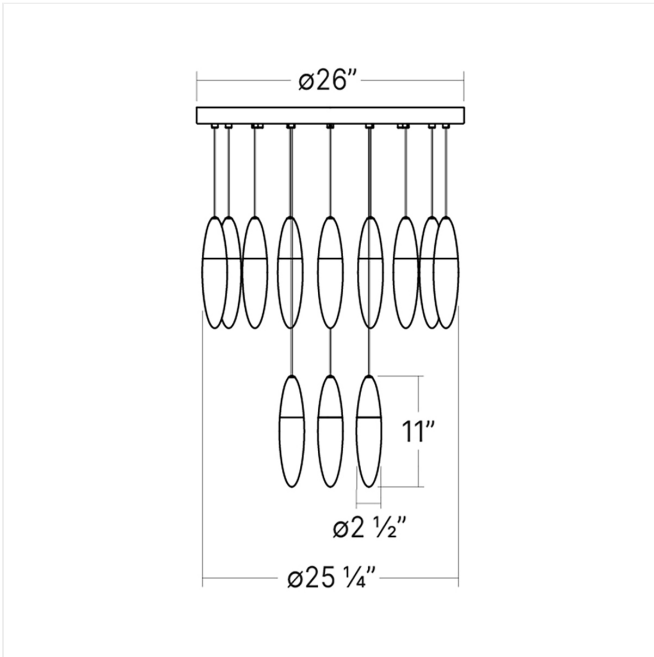

Dimensions

Height:	11"
Diameter:	25.25"
Canopy/Backplate/Base:	26"
Hanging Details:	20' Adjustable Cord
Size:	12 Light

Electrical Specs

Bulb(s) Included?:	Yes
Bulb 1 Type:	Integral LED
Bulb Quantity:	12
Input Voltage:	120-277VAC
Wattage:	3
Initial Lumens:	4800
Delivered Lumens:	3000
Color Temperature:	3000K
CRI:	90
Power Supply Type:	Driver
Power Supply Quantity:	1
Power Supply Location:	Canopy
Dimming Type:	TRIAC/ELV/0-10V

Installation

Installation:	Licensed electrician required
Sloped Ceiling Compatible?:	Compatible
Installation Orientation:	N/A
Minimum Hanging Height:	12"
Maximum Hanging Height:	252"

Shade

Shade Material:	Seeded Glass
-----------------	--------------

General Listings

Features:	Damp Rated
Certification:	C-ETL-US
Color/Finish:	Satin Brass (.38) w/ White Canopy

Available Finishes

Available Finishes:	Polished Chrome (.01), Satin Brass (.38)
---------------------	--

Available Color Temperatures

Available Color Temperatures:	3000k
-------------------------------	-------