

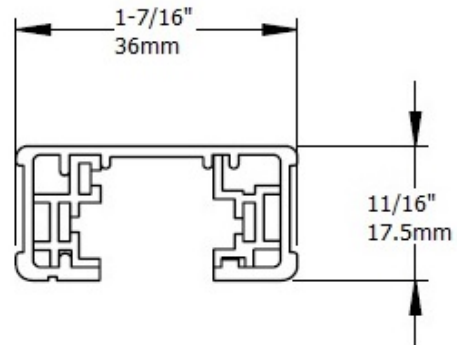

# H1 TRACK SYSTEM

**SINGLE CIRCUIT**  
120V

|             |  |
|-------------|--|
| Type        |  |
| Project     |  |
| Catalog No. |  |

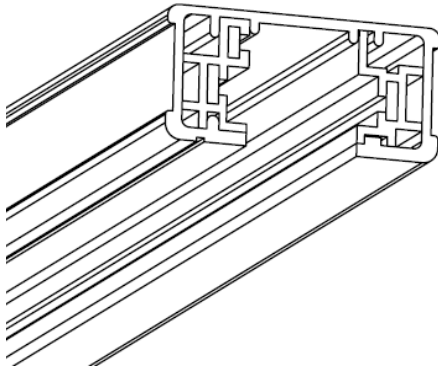

## DESCRIPTION

Track / Power Distribution System suitable for retail, commercial and residential use. Compatible with wide selection of JESCO H and H2 track lighting fixtures. Ships with one **H1EC** (end cap) installed.

### CONSTRUCTION

Extruded aluminum housing.  
Solid copper bus bars equivalent to #12 AWG wire.  
Independent ground conductor.

### MOUNTING

Surface mount to finished ceiling. Toggle bolts included.  
Suspend from finished ceiling using **HSK100** and appropriate stem.  
Add **SK101** adaptor for sloped ceiling.  
T-Bar ceiling mount using **TBC**.

### ELECTRICAL

120V 50/60 Hz 20A max

### LABELS

cULus Listed

## ORDERING INFORMATION

| TRACK SYSTEM          | LENGTH | FINISH      |
|-----------------------|--------|-------------|
| H1TR = Jesco H1 Track | 2 = 2' | -BK – Black |
|                       | 4 = 4' | -WT – White |
|                       | 6 = 6' |             |
|                       | 8 = 8' |             |

|      |  |   |
|------|--|---|
| H1TR |  | - |
|------|--|---|

### Power Feeds and Connectors

|               |                                  |
|---------------|----------------------------------|
| <b>H1LE</b>   | End feed                         |
| <b>H1LEC</b>  | End feed with outlet box cover   |
| <b>H1LEBX</b> | Conduit end feed                 |
| <b>H1FC</b>   | Floating canopy                  |
| <b>H1IJ</b>   | Mini I joiner                    |
| <b>H1ILP</b>  | Adjustable I or L connector/feed |
| <b>H1TP</b>   | Adjustable T connector/feed      |
| <b>H1XP</b>   | X connector/feed                 |
| <b>H1FLXJ</b> | Flexible joiner                  |

### Suspension

|               |                                   |
|---------------|-----------------------------------|
| <b>HSK100</b> | Suspension canopy                 |
| <b>HSK102</b> | Wireway cover for suspension      |
| <b>SK100</b>  | Suspension stem coupling          |
| <b>SK101</b>  | Sloped ceiling suspension adaptor |
| <b>SK106</b>  | 6" suspension stem                |
| <b>SK112</b>  | 12" suspension stem               |
| <b>SK118</b>  | 18" suspension stem               |
| <b>SK124</b>  | 24" suspension stem               |
| <b>SK136</b>  | 36" suspension stem               |
| <b>SK148</b>  | 48" suspension stem               |

### Accessories

|             |                  |
|-------------|------------------|
| <b>CP1</b>  | Outlet box cover |
| <b>H1EC</b> | End cap          |

### T-Bar Ceiling

|              |                          |
|--------------|--------------------------|
| <b>H1TBH</b> | T-Bar outlet box housing |
| <b>TBC</b>   | T-Bar attachment clip    |

### Fixture Extensions

|                 |                                    |
|-----------------|------------------------------------|
| <b>H2HVFE12</b> | 12" line voltage fixture extension |
| <b>H2HVFE18</b> | 18" line voltage fixture extension |
| <b>H2HVFE24</b> | 24" line voltage fixture extension |
| <b>H2HVFE36</b> | 36" line voltage fixture extension |
| <b>H2HVFE48</b> | 48" line voltage fixture extension |
| <b>LVFE06</b>   | 6" low voltage fixture extension   |
| <b>LVFE12</b>   | 12" low voltage fixture extension  |
| <b>LVFE18</b>   | 18" low voltage fixture extension  |
| <b>LVFE24</b>   | 24" low voltage fixture extension  |
| <b>LVFE36</b>   | 36" low voltage fixture extension  |
| <b>LVFE48</b>   | 48" low voltage fixture extension  |



www.jescolighting.com  
support@jescolighting.com  
Tech Support: 855.592.0029

15 Harbor Park Drive  
Port Washington, NY 11050  
Main Line: 800.527.7796  
Fax Line: 855.265.5768

219 South 6<sup>th</sup> Ave  
City of Industry, CA 91746  
Main Line: 855.654.0110  
Fax Line: 626.333.2955

Specifications subject to change without notice.

12/31/2015

Page 1



# H1 TRACK SYSTEM

**SINGLE CIRCUIT**  
120V

|             |  |
|-------------|--|
| Type        |  |
| Project     |  |
| Catalog No. |  |

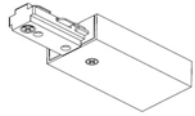

**H1LE**  
End Feed

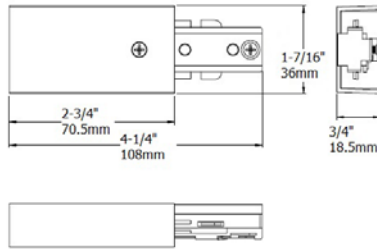

Direct wiring through ceiling with BX or end feed in suspension. **CP1** (outlet box cover) required over junction box. Accepts 3/8" or 1/2" (trade size) electrical fittings. Reversed polarity available upon request.

### ORDERING INFORMATION

| ITEM NO.                         | FINISH             |
|----------------------------------|--------------------|
| <b>H1LE</b> – End Feed           | <b>-BK</b> – Black |
| <b>H1LER</b> – Reversed Polarity | <b>-WT</b> – White |
| <b>H1LE</b>                      | -                  |

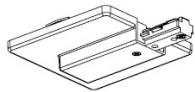

**H1LEC**  
End Feed with Outlet Box Cover

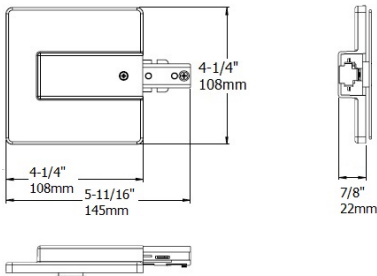

Wiring through junction box. Built-in junction box cover. Reversed polarity available upon request.

### ORDERING INFORMATION

| ITEM NO.                                    | FINISH             |
|---|--------------------|
| <b>H1LEC</b> – End Feed w/ Outlet Box Cover | <b>-BK</b> – Black |
| <b>H1LECR</b> – Reversed Polarity           | <b>-WT</b> – White |
| <b>H1LEC</b>                                | -                  |

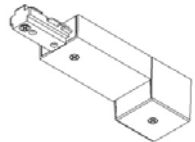

**H1LEBX**  
Conduit End Feed

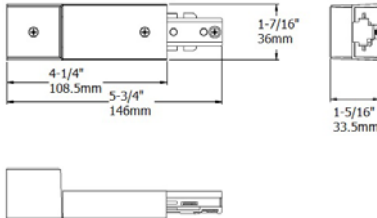

Surface conduit wiring. Accepts 3/8" or 1/2" (trade size) electrical fittings. Reversed polarity available upon request. Combine standard and reversed polarity for a conduit continuity kit.

### ORDERING INFORMATION

| ITEM NO.                           | FINISH             |
|------------------------------------|--------------------|
| <b>H1LEBX</b> – Conduit End Feed   | <b>-BK</b> – Black |
| <b>H1LEBXR</b> – Reversed Polarity | <b>-WT</b> – White |
| <b>H1LEBX</b>                      | -                  |

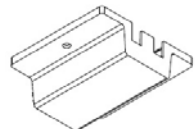

**H1FC**  
Floating Canopy

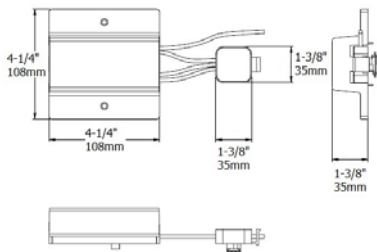

Wiring through junction box. Can be located anywhere along track. Comes with one **H1EC** (end cap).

### ORDERING INFORMATION

| ITEM NO.                      | FINISH             |
|-------------------------------|--------------------|
| <b>H1FC</b> – Floating Canopy | <b>-BK</b> – Black |
|                               | <b>-WT</b> – White |
| <b>H1FC</b>                   | -                  |

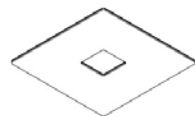

**CP1**  
Outlet Box Cover

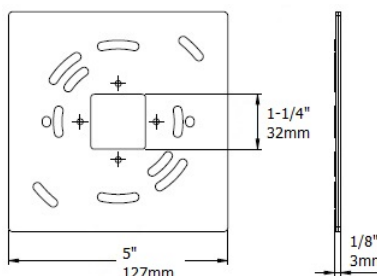

Covers 4" junction box at feed point.

### ORDERING INFORMATION

| ITEM NO.                      | FINISH             |
|-------------------------------|--------------------|
| <b>CP1</b> – Outlet box cover | <b>-BK</b> – Black |
|                               | <b>-WT</b> – White |
| <b>CP1</b>                    | -                  |



# H1 TRACK SYSTEM

SINGLE CIRCUIT  
120V

|             |  |
|-------------|--|
| Type        |  |
| Project     |  |
| Catalog No. |  |

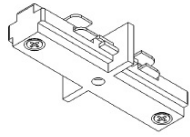

**H1IJ**  
Mini I Joiner

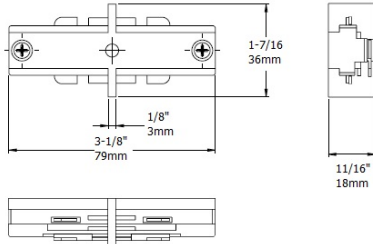

Connects two track sections. Low profile design for a clean continuous run.

| ORDERING INFORMATION |                            |
|----------------------|----------------------------|
| ITEM NO.             | FINISH                     |
| H1IJ – Mini I Joiner | -BK – Black<br>-WT – White |
| <b>H1IJ</b>          | -                          |

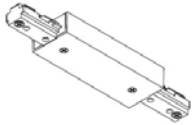

**H1ILP**  
Adjustable I or L Connector/Feed

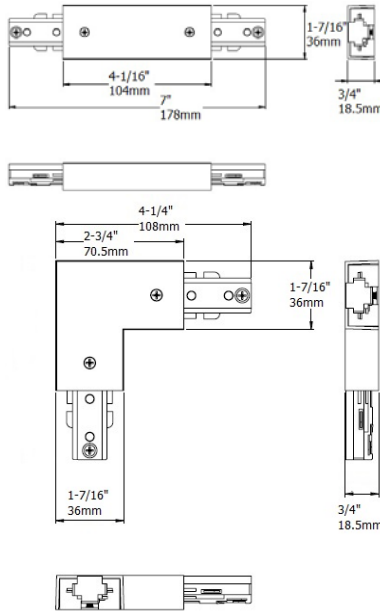

Connects two track sections in a straight or 90° configuration. Ships with 90° cover installed, straight cover included. May be used as feed point. **CP1** (outlet box cover) required over junction box.

| ORDERING INFORMATION          |                            |
|-------------------------------|----------------------------|
| ITEM NO.                      | FINISH                     |
| H1ILP – I or L Connector/Feed | -BK – Black<br>-WT – White |
| <b>H1ILP</b>                  | -                          |

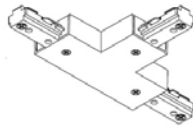

**H11TP**  
Adjustable T Connector/Feed

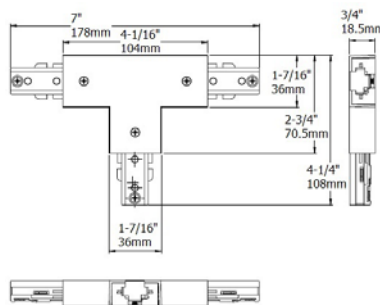

Connects three track sections in a T configuration. Adjustable for right or left application. May be used as feed point. **CP1** (outlet box cover) required over junction box.

| ORDERING INFORMATION     |                            |
|--------------------------|----------------------------|
| ITEM NO.                 | FINISH                     |
| H11TP – T Connector/Feed | -BK – Black<br>-WT – White |
| <b>H11TP</b>             | -                          |

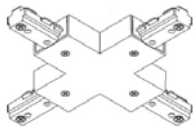

**H11XP**  
X Connector/Feed

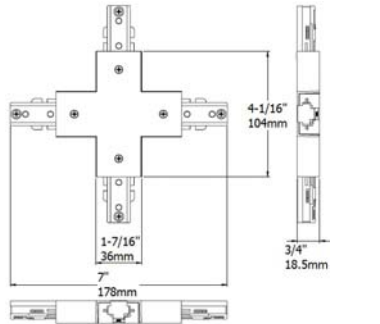

Connects four track sections in an X configuration. Factory wired for two separate 90° runs. May be field wired for one run. May be used as feed point. **CP1** (outlet box cover) required over junction box.

| ORDERING INFORMATION     |                            |
|--------------------------|----------------------------|
| ITEM NO.                 | FINISH                     |
| H11XP – X Connector/Feed | -BK – Black<br>-WT – White |
| <b>H11XP</b>             | -                          |



# H1 TRACK SYSTEM

SINGLE CIRCUIT  
120V

|             |  |
|-------------|--|
| Type        |  |
| Project     |  |
| Catalog No. |  |

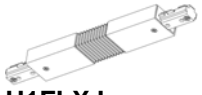

**H1FLXJ**  
Flexible Joiner

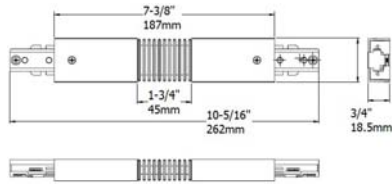

Connects two track sections up to 90° left, right, up or down.

### ORDERING INFORMATION

| ITEM NO.                 | FINISH                     |
|--------------------------|----------------------------|
| H1FLXJ – Flexible Joiner | -BK – Black<br>-WT – White |

|               |   |
|---------------|---|
| <b>H1FLXJ</b> | - |
|---------------|---|

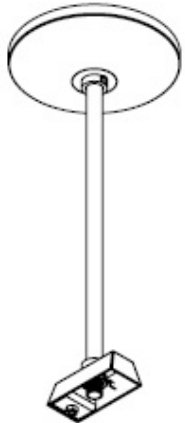

**HSK100**  
Suspension Canopy

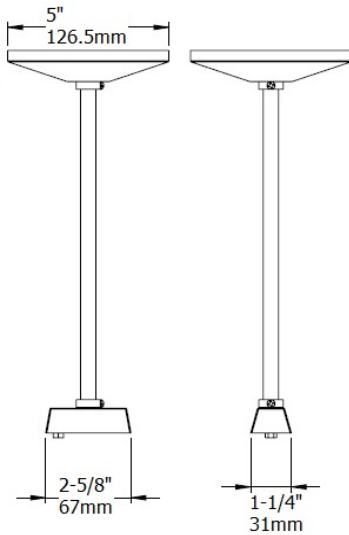

Suspend track from ceiling or junction box. Includes canopy and track bracket. Stem not included. Suspension stem in 6", 12", 18" 24", 36" and 48" are available to be ordered separately. Stem may be extended in any combination using **SK100** (suspension stem coupling).

For sloped ceiling application, add **SK101** (sloped ceiling suspension adaptor). One required per suspension canopy.

For electrical feed, add **HSK102** (wireway cover for suspension). One required per **H1LE** (end feed).

Use 2 per **H1TR2** (2' track) or **H1TR4** (4' track).  
Use 3 per **H1TR6** (6' track) or **H1TR8** (8' track).

### ORDERING INFORMATION

| ITEM NO.                   | FINISH                     |
|----------------------------|----------------------------|
| HSK100 – Suspension Canopy | -BK – Black<br>-WT – White |

|               |   |
|---------------|---|
| <b>HSK100</b> | - |
|---------------|---|



**SK1**  
Suspension Stem

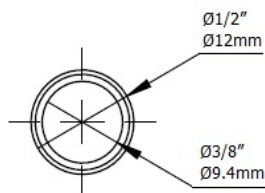

Suspend track from ceiling or junction box. Includes stem only. One required per **HSK100** (suspension canopy).

Available in 6", 12", 18" 24", 36" and 48". Stem may be extended in any combination using **SK100** (suspension stem coupling).

Use 2 per **H1TR2** (2' track) or **H1TR4** (4' track).  
Use 3 per **H1TR6** (6' track) or **H1TR8** (8' track).

### ORDERING INFORMATION

| ITEM NO. | LENGTH                   | FINISH      |
|----------|--------------------------|-------------|
| SK1      | 06 – 6" Suspension Stem  | -BK – Black |
|          | 12 – 12" Suspension Stem | -WT – White |
|          | 18 – 18" Suspension Stem |             |
|          | 24 – 24" Suspension Stem |             |
|          | 36 – 36" Suspension Stem |             |
|          | 48 – 48" Suspension Stem |             |

|            |  |   |
|------------|--|---|
| <b>SK1</b> |  | - |
|------------|--|---|



# H1 TRACK SYSTEM

SINGLE CIRCUIT  
120V

|             |  |
|-------------|--|
| Type        |  |
| Project     |  |
| Catalog No. |  |

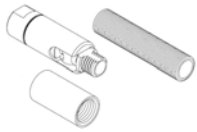

**SK101**  
Sloped Ceiling  
Suspension  
Adaptor

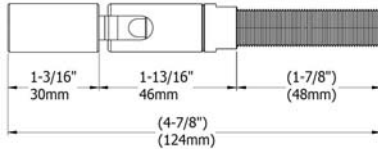

Suspend track from sloped ceiling. Use in conjunction with **HSK100** (suspension canopy). May be used to feed electrical wire up to 60° angle.

### ORDERING INFORMATION

| ITEM NO.                              | FINISH                                   |
|---------------------------------------|--|
| <b>SK101</b> – Sloped Ceiling Adaptor | <b>-BK</b> – Black<br><b>-WT</b> – White |

|              |   |
|--------------|---|
| <b>SK101</b> | - |
|--------------|---|



**HSK102**  
Wireway Cover  
for Suspension

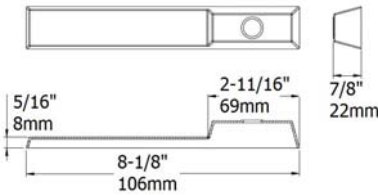

Conceals electrical feed wire from stem to **H1LE** (end feed). One required per **H1LE** (end feed).

### ORDERING INFORMATION

| ITEM NO.                      | FINISH                                   |
|-------------------------------|--|
| <b>HSK102</b> – Wireway Cover | <b>-BK</b> – Black<br><b>-WT</b> – White |

|               |   |
|---------------|---|
| <b>HSK102</b> | - |
|---------------|---|

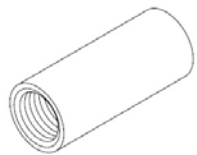

**SK100**  
Suspension  
Stem Coupling

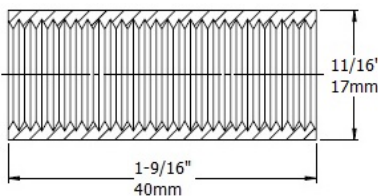

Connects two suspension stems to extend the drop. Suspension stem in 6", 12", 18" 24", 36" and 48" may be extended in any combination.

### ORDERING INFORMATION

| ITEM NO.                                | FINISH                                   |
|---|--|
| <b>SK100</b> – Suspension Stem Coupling | <b>-BK</b> – Black<br><b>-WT</b> – White |

|              |   |
|--------------|---|
| <b>SK100</b> | - |
|--------------|---|

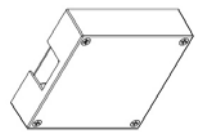

**H1TBH**  
T-Bar Outlet Box  
Housing

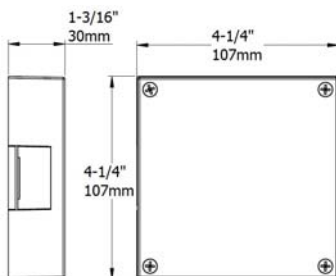

Direct wiring through ceiling tile with BX when T-Bar is directly above track. Accepts 3/8" or 1/2" (trade size) electrical fittings. Requires **H1LE**, **H1ILP**, **H1TP** or **H1XP**.

### ORDERING INFORMATION

| ITEM NO.                                | FINISH             |
|---|--------------------|
| <b>H1TBH</b> – T-Bar Outlet Box Housing | <b>-WT</b> – White |

|              |            |
|--------------|------------|
| <b>H1TBH</b> | <b>-WT</b> |
|--------------|------------|

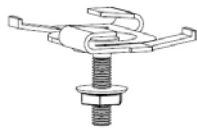

**TBC**  
T-Bar  
Attachment Clip

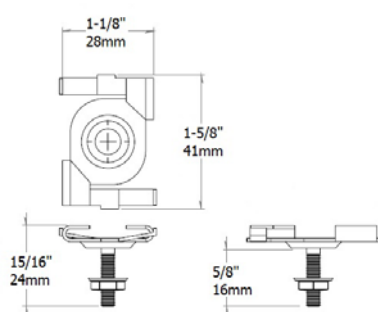

Twists on to T-grid for fast, easy and secure installation. Fits 15/16" T-grid. Supports up to 25-lbs static load.

Use 2 per **H1TR2** (2' track) or **H1TR4** (4' track).  
Use 3 per **H1TR6** (6' track) or **H1TR8** (8' track).

### ORDERING INFORMATION

| ITEM NO.                           |
|------------------------------------|
| <b>TBC</b> – T-Bar Attachment Clip |

|            |
|------------|
| <b>TBC</b> |
|------------|



# H1 TRACK SYSTEM

SINGLE CIRCUIT  
120V

|             |  |
|-------------|--|
| Type        |  |
| Project     |  |
| Catalog No. |  |

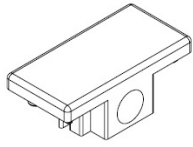

**H1EC**  
■ ■ ■  
End Cap

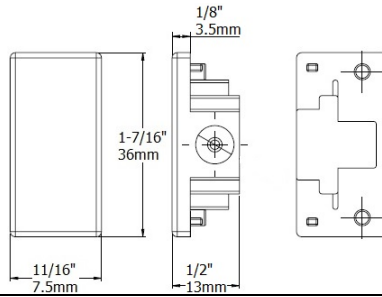

Covers end of track section. One included with each H1TR (JESCO H1 track).

| ORDERING INFORMATION |                            |
|----------------------|----------------------------|
| ITEM NO.             | FINISH                     |
| H1EC – End cap       | -BK – Black<br>-WT – White |
| <b>H1EC</b>          | -                          |



**H2HVFE**  
■ ■ ■  
Line Voltage  
Fixture  
Extension

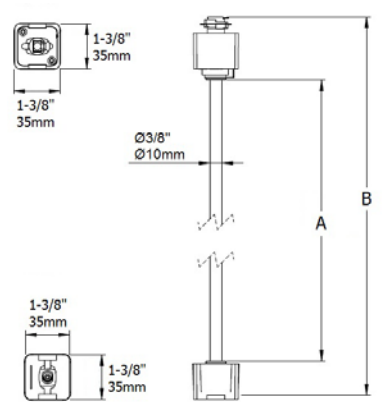

Extends line voltage fixture from track. For use with H1TR (JESCO H1 track).

| ORDERING INFORMATION                    |  |                            |
|---|--|----------------------------|
| ITEM NO.                                | LENGTH   | FINISH                     |
| H2HVFE – Line voltage fixture extension | 12 – A=12"/B=14.5"<br>18 – A=18"/B=20.5"<br>24 – A=24"/B=26.5"<br>36 – A=36"/B=38.5"<br>48 – A=48"/B=50.5" | -BK – Black<br>-WT – White |
| <b>H2HVFE</b>                           |  | -                          |

**LVFE**  
■ ■ ■  
Low Voltage  
Fixture  
Extension

Extends low voltage fixture lamp housing from transformer housing. Factory assembled.

| ORDERING INFORMATION                 |  |                            |
|--------------------------------------|--|----------------------------|
| ITEM NO.                             | LENGTH   | FINISH                     |
| LVFE – Low voltage fixture extension | 06 – 6" (8.5" actual)<br>12 – 12" (14.5" actual)<br>18 – 18" (20.5" actual)<br>24 – 24" (26.5" actual)<br>36 – 36" (38.5" actual)<br>48 – 48" (50.5" actual) | -BK – Black<br>-WT – White |
| <b>LVFE</b>                          |  | -                          |