



TROY RLM LIGHTING



5526

Troy RLM

Troy RLM sets the standard for Reflector Luminaire Manufacturer. We are primarily commercial or industrial lighting fixtures that are designed to reflect light in a downward direction.

Troy Lighting has been manufacturing RLM's in our USA facility for over 20 years. Many of our RLM's are inspired by historical lighting designs, but we have recently updated the RLM's by Troy Lighting to include some of the most unique modern, contemporary and transitional styles for this category.

Our latest Troy Lighting RLM catalog features the full array of our MADE IN USA fixtures, featuring a vast variety of finish, lamping, and mounting options.

② Table of Contents



AeroP. 4



Emblem.....P. 20



Angle ReflectorP. 6



FreshP. 22



Archetype.....P. 8



GlobeP. 24



Bell.....P. 10



Heavy Duty.....P. 26



Bird CageP. 12



Heavy MetalP. 28



ClassicP. 14



LS Series.....P. 30



Deep ReflectorP. 16



Mid Century.....P. 32



DomeP.18



ModernP. 34



Table of Contents 3



NeoP. 36



NostalgiaP. 38



Paradigm.....P. 40



Radial WaveP. 42



RDX.....P. 44



Retro IndustrialP. 46



Shallow Heavy Duty.....P. 48



StandardP. 50



TearP. 52



Mounts P. 54



Accessories.....P. 57



Structure P. 58



FinishesP. 60

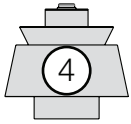

AERO

Electrical

- 120V input (277V available in arm and post option only)
- Integrated power supply allows the fixture to be connected directly into line voltage
- Pre-wired and ready for install
- Dimmable with Incandescent/Triac dimmers

Mounting

- 1/2" or 3/4" IP for arms. Flush mount, stems and post available only in 1/2", see next page
- 9' Pendant cord available in black or white cord (includes 5" canopy with the same finish as the shade)

Finishes

- Two-toned outer and inner shade
- Available in 21 standard and 2 specialty finishes with optional coastal coating to protect finish in coastal environments (add "-C" to the finish)
- Consult factory for custom finish options

Listing

UL listed to US and Canadian standards for wet locations



AE14LED1127TNGSGW-W

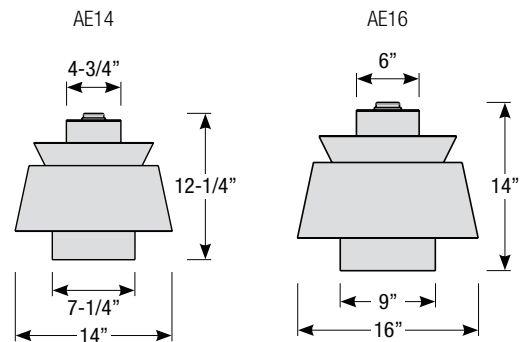

Aero Order Matrix (Example: AE14LED1127TNGSGW-W)

Diameter	LED Light Engine	Inner Shade Finish	Outer Shade Finish	Coastal Coating	Mounting Type
AE14 (14")	LED1127 ¹ (11W LED / 2700K / 90 CRI / 1188lm)	ABL (Aegean Blue)	ABL (Aegean Blue)	(blank) (No coating)	-2 (1/2" IP)
AE16 (16")	LED1130 ¹ (11W LED / 3000K / 90 CRI / 1265lm)	BB (Burnished Bronze)	BB (Burnished Bronze)	-C ² (Coating)	-3 (3/4" IP)
	LED1135 ¹ (11W LED / 3500K / 90 CRI / 1305lm)	BK (Gloss Black)	BK (Gloss Black)		-B (Black Cord Pendant)
	LED1140 ¹ (11W LED / 4000K / 90 CRI / 1364lm)	BLU (Blue)	BLU (Blue)		-W (White Cord Pendant)
	LED1527 ¹ (15W LED / 2700K / 90 CRI / 1620lm)	DVG (Dove Gray)	DVG (Dove Gray)		-F (Flush Mount)
	LED1530 ¹ (15W LED / 3000K / 90 CRI / 1725lm)	FLG (Flannel Gray)	FLG (Flannel Gray)		
	LED1535 ¹ (15W LED / 3500K / 90 CRI / 1780lm)	GA (Galvanized)	GA (Galvanized)		
	LED1540 ¹ (15W LED / 4000K / 90 CRI / 1860lm)	LG (Lime Green)	LG (Lime Green)		
		MB (Matte Black)	MB (Matte Black)		
		MBL (Midnight Blue)	MBL (Midnight Blue)		
		PNA (Painted Natural Aluminum)	PNA (Painted Natural Aluminum)		
		PNC (Painted Natural Copper)	PNC (Painted Natural Copper)		
		RD (Red)	RD (Red)		
		SA (Satin Aluminum)	SA (Satin Aluminum)		
		SGR (Sage Green)	SGR (Sage Green)		
		SGW (Semi Gloss White)	SGW (Semi Gloss White)		
		SND (Sand)	SND (Sand)		
		SS (Satin Silver)	SS (Satin Silver)		
		TBZ (Textured Bronze)	TBZ (Textured Bronze)		
		TGP (Textured Graphite)	TGP (Textured Graphite)		
		TNG (Tangerine)	TNG (Tangerine)		
		TTL (Tahitian Teal)	TTL (Tahitian Teal)		
		WT (Gloss White)	WT (Gloss White)		

1. Lamp/LED included

2. Satin aluminum cannot be coated



Compatible Mounts - see pages 56-58 for detailed specs

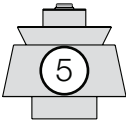

Arm Mount Order Matrix (Example: 3SL23TNG)

Pipe Size	Arm Type	Finish	Coastal Coating	Input Voltage	
2 (1/2" IP)	SL23 (Small Loop- 23")	(Specify finish - see available finishes on right)	(blank) (No coating)	(blank) (120V)	
3 (3/4" IP)	SL30 (Small Loop- 30")		-C ² (Coating)	-27 (277V)	
	LL23 (Large Loop - 23")				
	LL30 (Large Loop - 30")				
	LC18 (Curve Arm - 18")				
	LC24 (Curve Arm - 24")				
	LC30 (Curve Arm - 30")				
	LM18 (Miter Arm - 18")				
	LM24 (Miter Arm - 24")				
	LM30 (Miter Arm - 30")				
	SA18 (Sign Arm - 18")				
	SA23 (Sign Arm - 23")				
	LSA23 (Large Loop Sign Arm - 23")				
	LSA30 (Large Loop Sign Arm - 30")				
	A6 (Straight Arm - 6")				
	A12 (Straight Arm - 12")				
	A18 (Straight Arm - 18")				
	A24 (Straight Arm - 24")				
	A30 (Straight Arm - 30")				
	MA18 (Modern Arm - 18")				
	MA24 (Modern Arm - 24")				
	MA30 (Modern Arm - 30")				

2. Satin aluminum cannot be coated

Knuckle Accessory Order Matrix (Example: 2KNLTNG)

Pipe Size	Knuckle	Finish	Coastal Coating
2 (1/2" IP)	KNL (Adjustable 180° Knuckle for Arm Mounts)	(Specify finish - see available finishes on right)	(blank) (No coating)
3 (3/4" IP)			-C ² (Coating)

2. Satin aluminum cannot be coated

Post / Wall Mount Order Matrix (Example: 2W1TNG)

Pipe Size	Mount Type	Finish	Input Voltage
2 (1/2" IP)	P1 (Single Post Mount)	(Specify finish - see available finishes on right)	(blank) (120V)
	P2 (Double Post Mount)		-27 ³ (277V)
	W1 (Traditional Wall Mount)		

3. Post mount only

Post Type Order Matrix (Example: P8683-96TNG)

Post Type	Finish
PM4946 (Cast Aluminum Post)	(Specify finish - see available finishes on right)
P8683-96 (Cast Aluminum Base w/ 96" Aluminum Post)	
P8683-120 (Cast Aluminum Base w/ 120" Aluminum Post)	
P8684-96 (96" Straight Aluminum Post)	
P8684-120 (120" Straight Aluminum Post)	
PM8685 (Cast Aluminum Pier Mount - must be used with straight aluminum post, P8683)	

Stem Mount Order Matrix (Example: 2HS18TNG)

Pipe Size	Stem Length	Finish	Coastal Coating
2 (1/2" IP)	HS12 (12")	(Specify finish - see available finishes on right)	(blank) (No coating)
	HS18 (18")		-C ² (Coating)
	HS24 (24")		
	HS36 (36")		
	HS48 (48")		
	HS__ (Custom length from 2" up to 60")		

2. Satin aluminum cannot be coated

Finishes	
	ABL (Aegean Blue)
	BB (Burnished Bronze)
	BK (Gloss Black)
	BLU (Blue)
	DVG (Dove Gray)
	FLG (Flannel Gray)
	GA^{4,5} (Galvanized)
	LG (Lime Green)
	MB (Matte Black)
	MBL (Midnight Blue)
	PNA (Painted Natural Aluminum)
	PNC (Painted Natural Copper)
	RD (Red)
	SA^{2,4,5} (Satin Aluminum)
	SGR (Sage Green)
	SGW (Semi Gloss White)
	SND (Sand)
	SS (Satin Silver)
	TBZ (Textured Bronze)
	TGP (Textured Graphite)
	TNG (Tangerine)
	TTL (Tahitian Teal)
	WT (Gloss White)

2. Satin aluminum cannot be coastal coated
 4. Post mount cannot be painted with specialty finishes
 5. Specialty Finish



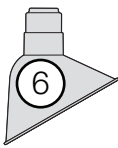

ANGLE REFLECTOR

Electrical

- 120V input (277V available in arm and post option only)
- Integrated power supply allows the fixture to be connected directly into line voltage
- Pre-wired and ready for install
- LED is dimmable with Incandescent/Triac dimmers

Mounting

- 1/2" or 3/4" IP for arms. Flush mount and post available only in 1/2", see next page

Finishes

- Shade and mounting finish options
- Available in 21 standard and 2 specialty finishes with optional coastal coating to protect finish in coastal environments (add "-C" to the finish)
- Inner shade is painted gloss white
- Consult factory for custom finish options

Optional Accessories

- Glass, Cast Guard, Wire Cage or Wire Guard options available, see page 57

Listing

UL listed to US and Canadian standards for wet locations



RA10LED1127GA-2 / 2SL23GA

RA8LED1127RD-2 / 2SL30RD

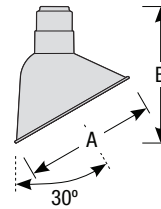

	A	B
RA8	8"	9"
RA10	10"	11"
RA12	12"	12-1/2"

Angle Reflector Order Matrix (Example: RA10LED1127GA-2)

Diameter	Lamp / LED	Finish	Coastal Coating	Accessories	Mounting Type
RA8 (8")	M (Medium Base, 100W max.)	ABL (Aegean Blue)	(blank) (No coating)	(blank) (No accessories)	-2 (1/2" IP)
RA10 (10")	GU2413 ^{1,2} (13W GU24 / 2700K)	BB (Burnished Bronze)	-C⁴ (Coating)	-CG (Clear Glass)	-3 (3/4" IP)
RA12 (12")	GU2418 ^{1,2} (18W GU24 / 2700K)	BK (Gloss Black)		-FG (Frosted Glass)	-F (Flush Mount)
	GU2426 ^{1,2} (26W GU24 / 2700K)	BLU (Blue)		-OG (Opal Glass)	
	GU2432 ^{1,2} (32W GU24 / 2700K)	DVG (Dove Gray)		-CGG (Clear Glass w/ Cast Guard)	
	GU2442 ^{1,2} (42W GU24 / 2700K)	FLG (Flannel Gray)		-FGG (Frosted Glass w/ Cast Guard)	
	LED1127 ^{1,3} (11W LED / 2700K / 90 CRI / 1188lm)	GA (Galvanized)		-OGG (Opal Glass w/ Cast Guard)	
	LED1130 ^{1,3} (11W LED / 3000K / 90 CRI / 1265lm)	LG (Lime Green)		-CGWC (Clear Glass w/ Wire Cage)	
	LED1135 ^{1,3} (11W LED / 3500K / 90 CRI / 1305lm)	MB (Matte Black)		-FGWC (Frosted Glass w/ Wire Cage)	
	LED1140 ^{1,3} (11W LED / 4000K / 90 CRI / 1364lm)	MBL (Midnight Blue)		-OGWC (Opal Glass w/ Wire Cage)	
	LED1527 ^{1,3} (15W LED / 2700K / 90 CRI / 1620lm)	PNA (Painted Natural Aluminum)		-WG (Wire Guard)	
	LED1530 ^{1,3} (15W LED / 3000K / 90 CRI / 1725lm)	PNC (Painted Natural Copper)			
	LED1535 ^{1,3} (15W LED / 3500K / 90 CRI / 1780lm)	RD (Red)			
	LED1540 ^{1,3} (15W LED / 4000K / 90 CRI / 1860lm)	SA (Satin Aluminum)			
		SGR (Sage Green)			
		SGW (Semi Gloss White)			
		SND (Sand)			
		SS (Satin Silver)			
		TBZ (Textured Bronze)			
		TGP (Textured Graphite)			
		TNG (Tangerine)			
		TTL (Tahitian Teal)			
		WT (Gloss White)			

1. Lamp/LED included
 2. Not for use in glass/cast guard/wire cage
 3. Glass enclosure must be specified

4. Satin aluminum cannot be coated



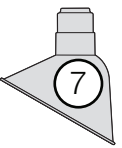

Compatible Mounts - see pages 56-58 for detailed specs

Arm Mount Order Matrix

(Example: 2SL30RD)

Pipe Size	Arm Type	Finish	Coastal Coating	Input Voltage
2 (1/2" IP)	SL23 (Small Loop - 23")	(Specify finish - see available finishes on right)	(blank) (No coating)	(blank) (120V)
3 (3/4" IP)	SL30 (Small Loop - 30")		-C ⁴ (Coating)	-27 (277V)
	LL23 (Large Loop - 23")			
	LL30 (Large Loop - 30")			
	LC18 (Curve Arm - 18")			
	LC24 (Curve Arm - 24")			
	LC30 (Curve Arm - 30")			
	LM18 (Miter Arm - 18")			
	LM24 (Miter Arm - 24")			
	LM30 (Miter Arm - 30")			
	SA18 (Sign Arm - 18")			
	SA23 (Sign Arm - 23")			
	LSA23 (Large Loop Sign Arm - 23")			
	LSA30 (Large Loop Sign Arm - 30")			
	A6 (Straight Arm - 6")			
	A12 (Straight Arm - 12")			
	A18 (Straight Arm - 18")			
	A24 (Straight Arm - 24")			
	A30 (Straight Arm - 30")			
	MA18 (Modern Arm - 18")			
	MA24 (Modern Arm - 24")			
	MA30 (Modern Arm - 30")			

4. Satin aluminum cannot be coated

Knuckle Accessory Order Matrix (Example: 2KNLRD)

Pipe Size	Knuckle	Finish	Coastal Coating
2 (1/2" IP)	KNL (Adjustable 180° Knuckle for Arm Mounts)	(Specify finish - see available finishes on right)	(blank) (No coating)
3 (3/4" IP)			-C ⁴ (Coating)

4. Satin aluminum cannot be coated

Post / Wall Mount Order Matrix (Example: 2W1RD)

Pipe Size	Mount Type	Finish	Input Voltage
2 (1/2" IP)	P1 (Single Post Mount)	(Specify finish - see available finishes on right)	(blank) (120V)
	P2 (Double Post Mount)		-27 ⁵ (277V)
	W1 (Traditional Wall Mount)		

5. Post mount only

Post Type Order Matrix (Example: P8683-96RD)

Post Type	Finish
PM4946 (Cast Aluminum Post)	(Specify finish - see available finishes on right)
P8683-96 (Cast Aluminum Base w/ 96" Aluminum Post)	
P8683-120 (Cast Aluminum Base w/ 120" Aluminum Post)	
P8684-96 (96" Straight Aluminum Post)	
P8684-120 (120" Straight Aluminum Post)	
PM8685 (Cast Aluminum Pier Mount - must be used with straight aluminum post, P8683)	

Finishes	
	ABL (Aegean Blue)
	BB (Burnished Bronze)
	BK (Gloss Black)
	BLU (Blue)
	DVG (Dove Gray)
	FLG (Flannel Gray)
	GA ^{6,7} (Galvanized)
	LG (Lime Green)
	MB (Matte Black)
	MBL (Midnight Blue)
	PNA (Painted Natural Aluminum)
	PNC (Painted Natural Copper)
	RD (Red)
	SA ^{4,6,7} (Satin Aluminum)
	SGR (Sage Green)
	SGW (Semi Gloss White)
	SND (Sand)
	SS (Satin Silver)
	TBZ (Textured Bronze)
	TGP (Textured Graphite)
	TNG (Tangerine)
	TTL (Tahitian Teal)
	WT (Gloss White)

4. Satin aluminum cannot be coastal coated
 6. Post mount cannot be painted with specialty finishes
 7. Specialty Finish



ARCHETYPE

Electrical

- 120V input (277V available in arm and post option only)
- Integrated power supply allows the fixture to be connected directly into line voltage
- Pre-wired and ready for install
- LED is dimmable with Incandescent/Triac dimmers

Mounting

- 1/2" or 3/4" IP for arms. Flush mount, stems and post available only in 1/2", see next page
- 9' Pendant cord available in black or white cord (includes 5" canopy with the same finish as the shade)

Finishes

- Shade and mounting finish options
- Available in 21 standard and 2 specialty finishes with optional coastal coating to protect finish in coastal environments (add "-C" to the finish)
- Inner shade is painted gloss white
- Consult factory for custom finish options

Optional Accessories

- Glass, Cast Guard or Wire Cage options available, see page 57

Listing

UL listed to US and Canadian standards for wet locations



AR16MTBZ-CGWC-3 / 3SL23TBZ

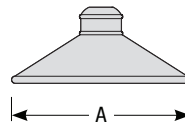

	A	B
AR14	14"	6"
AR16	16"	6"

Archetype Order Matrix (Example: AR16MTBZ-CGWC-3)

Diameter	Lamp / LED	Finish	Coastal Coating	Accessories	Mounting Type
AR14 (14-1/8")	M (Medium Base, 100W max.)	ABL (Aegean Blue)	(blank) (No coating)	(blank) (No accessories)	-2 (1/2" IP)
AR16 (16-1/8")	GU2413 ¹ (13W GU24 / 2700K)	BB (Burnished Bronze)	-C ⁴ (Coating)	-CG (Clear Glass)	-3 (3/4" IP)
	GU2418 ¹ (18W GU24 / 2700K)	BK (Gloss Black)		-FG (Frosted Glass)	-B (Black Cord Pendant)
	GU2426 ¹ (26W GU24 / 2700K)	BLU (Blue)		-OG (Opal Glass)	-W (White Cord Pendant)
	GU2432 ^{1,2} (32W GU24 / 2700K)	DVG (Dove Gray)		-CGG (Clear Glass w/ Cast Guard)	-F (Flush Mount)
	GU2442 ^{1,2} (42W GU24 / 2700K)	FLG (Flannel Gray)		-FGG (Frosted Glass w/ Cast Guard)	
	LED1127 ^{1,3} (11W LED / 2700K / 90 CRI / 1188lm)	GA (Galvanized)		-OGG (Opal Glass w/ Cast Guard)	
	LED1130 ^{1,3} (11W LED / 3000K / 90 CRI / 1265lm)	LG (Lime Green)		-CGWC (Clear Glass w/ Wire Cage)	
	LED1135 ^{1,3} (11W LED / 3500K / 90 CRI / 1305lm)	MB (Matte Black)		-FGWC (Frosted Glass w/ Wire Cage)	
	LED1140 ^{1,3} (11W LED / 4000K / 90 CRI / 1364lm)	MBL (Midnight Blue)		-OGWC (Opal Glass w/ Wire Cage)	
	LED1527 ^{1,3} (15W LED / 2700K / 90 CRI / 1620lm)	PNA (Painted Natural Aluminum)			
	LED1530 ^{1,3} (15W LED / 3000K / 90 CRI / 1725lm)	PNC (Painted Natural Copper)			
	LED1535 ^{1,3} (15W LED / 3500K / 90 CRI / 1780lm)	RD (Red)			
	LED1540 ^{1,3} (15W LED / 4000K / 90 CRI / 1860lm)	SA (Satin Aluminum)			
		SGR (Sage Green)			
		SGW (Semi Gloss White)			
		SND (Sand)			
		SS (Satin Silver)			
		TBZ (Textured Bronze)			
		TGP (Textured Graphite)			
		TNG (Tangerine)			
		TTL (Tahitian Teal)			
		WT (Gloss White)			

1. Lamp/LED included
 2. Not for use in glass/cast guard/wire cage
 3. Glass enclosure must be specified

4. Satin aluminum cannot be coated



Compatible Mounts - see pages 56-58 for detailed specs

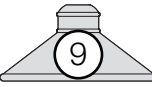

Arm Mount Order Matrix (Example: 3SL23TBZ)

Pipe Size	Arm Type	Finish	Coastal Coating	Input Voltage
2 (1/2" IP)	SL23 (Small Loop - 23")	(Specify finish - see available finishes on right)	(blank) (No coating)	(blank) (120V)
3 (3/4" IP)	SL30 (Small Loop - 30")		-C ⁴ (Coating)	-27 (277V)
	LL23 (Large Loop - 23")			
	LL30 (Large Loop - 30")			
	LC18 (Curve Arm - 18")			
	LC24 (Curve Arm - 24")			
	LC30 (Curve Arm - 30")			
	LM18 (Miter Arm - 18")			
	LM24 (Miter Arm - 24")			
	LM30 (Miter Arm - 30")			
	SA18 (Sign Arm - 18")			
	SA23 (Sign Arm - 23")			
	LSA23 (Large Loop Sign Arm - 23")			
	LSA30 (Large Loop Sign Arm - 30")			
	A6 (Straight Arm - 6")			
	A12 (Straight Arm - 12")			
	A18 (Straight Arm - 18")			
	A24 (Straight Arm - 24")			
	A30 (Straight Arm - 30")			
	MA18 (Modern Arm - 18")			
	MA24 (Modern Arm - 24")			
	MA30 (Modern Arm - 30")			

4. Satin aluminum cannot be coated

Knuckle Accessory Order Matrix (Example: 2KNLTBZ)

Pipe Size	Knuckle	Finish	Coastal Coating
2 (1/2" IP)	KNL (Adjustable 180° Knuckle for Arm Mounts)	(Specify finish - see available finishes on right)	(blank) (No coating)
3 (3/4" IP)			-C ⁴ (Coating)

4. Satin aluminum cannot be coated

Post / Wall Mount Order Matrix (Example: 2W1TBZ)

Pipe Size	Mount Type	Finish	Input Voltage
2 (1/2" IP)	P1 (Single Post Mount)	(Specify finish - see available finishes on right)	(blank) (120V)
	P2 (Double Post Mount)		-27 ⁵ (277V)
	W1 (Traditional Wall Mount)		

5. Post mount only

Post Type Order Matrix (Example: P8683-96TBZ)

Post Type	Finish
PM4946 (Cast Aluminum Post)	(Specify finish - see available finishes on right)
P8683-96 (Cast Aluminum Base w/ 96" Aluminum Post)	
P8683-120 (Cast Aluminum Base w/ 120" Aluminum Post)	
P8684-96 (96" Straight Aluminum Post)	
P8684-120 (120" Straight Aluminum Post)	
PM8685 (Cast Aluminum Pier Mount - must be used with straight aluminum post, P8683)	

Stem Mount Order Matrix (Example: 2HS18TBZ)

Pipe Size	Stem Length	Finish	Coastal Coating
2 (1/2" IP)	HS12 (12")	(Specify finish - see available finishes on right)	(blank) (No coating)
	HS18 (18")		-C ⁴ (Coating)
	HS24 (24")		
	HS36 (36")		
	HS48 (48")		
	HS__ (Custom length from 2" up to 60")		

4. Satin aluminum cannot be coated

Finishes	
	ABL (Aegean Blue)
	BB (Burnished Bronze)
	BK (Gloss Black)
	BLU (Blue)
	DVG (Dove Gray)
	FLG (Flannel Gray)
	GA^{6,7} (Galvanized)
	LG (Lime Green)
	MB (Matte Black)
	MBL (Midnight Blue)
	PNA (Painted Natural Aluminum)
	PNC (Painted Natural Copper)
	RD (Red)
	SA^{4,6,7} (Satin Aluminum)
	SGR (Sage Green)
	SGW (Semi Gloss White)
	SND (Sand)
	SS (Satin Silver)
	TBZ (Textured Bronze)
	TGP (Textured Graphite)
	TNG (Tangerine)
	TTL (Tahitian Teal)
	WT (Gloss White)

4. Satin aluminum cannot be coastal coated
 6. Post mount cannot be painted with specialty finishes
 7. Specialty Finish





BELL

Electrical

- 120V input (277V available in arm and post option only)
- Integrated power supply allows the fixture to be connected directly into line voltage
- Pre-wired and ready for install
- LED is dimmable with Incandescent/Triac dimmers

Mounting

- 1/2" or 3/4" IP for arms. Flush mount, stems and post available only in 1/2", see next page
- 9' Pendant cord available in black or white cord (includes 5" canopy with the same finish as the shade)

Finishes

- Two-toned shade and lens ring finish options
- Available in 21 standard and 2 specialty finishes with optional coastal coating to protect finish in coastal environments (add "-C" to the finish)
- Consult factory for custom finish options

Listing

UL listed to US and Canadian standards for wet locations

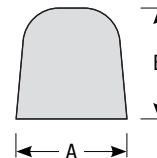

	A	B
BL8	8"	8-1/2"
BL10	10"	10"
BL12	12"	12"

Bell Order Matrix (Example: BL12MSGWTNG-3)

Diameter	Lamp / LED	Shade Finish	Lens Ring Finish	Coastal Coating	Mounting Type
BL8 (8")	M (Medium Base, 100W max.)	ABL (Aegean Blue)	ABL (Aegean Blue)	(blank) (No coating)	-2 (1/2" IP)
BL10 (10")	GU2413 ¹ (13W GU24 / 2700K)	BB (Burnished Bronze)	BB (Burnished Bronze)	-C ⁴ (Coating)	-3 (3/4" IP)
BL12 (12")	GU2418 ¹ (18W GU24 / 2700K)	BK (Gloss Black)	BK (Gloss Black)		-B (Black Cord Pendant)
	GU2426 ¹ (26W GU24 / 2700K)	BLU (Blue)	BLU (Blue)		-W (White Cord Pendant)
	GU2432 ^{1,2} (32W GU24 / 2700K)	DVG (Dove Gray)	DVG (Dove Gray)		-F (Flush Mount)
	GU2442 ^{1,2} (42W GU24 / 2700K)	FLG (Flannel Gray)	FLG (Flannel Gray)		
	LED1127 ¹ (11W LED / 2700K / 90 CRI / 1188lm)	GA (Galvanized)	GA (Galvanized)		
	LED1130 ¹ (11W LED / 3000K / 90 CRI / 1265lm)	LG (Lime Green)	LG (Lime Green)		
	LED1135 ¹ (11W LED / 3500K / 90 CRI / 1305lm)	MB (Matte Black)	MB (Matte Black)		
	LED1140 ¹ (11W LED / 4000K / 90 CRI / 1364lm)	MBL (Midnight Blue)	MBL (Midnight Blue)		
	LED1527 ¹ (15W LED / 2700K / 90 CRI / 1620lm)	PNA (Painted Natural Aluminum)	PNA (Painted Natural Aluminum)		
	LED1530 ¹ (15W LED / 3000K / 90 CRI / 1725lm)	PNC (Painted Natural Copper)	PNC (Painted Natural Copper)		
	LED1535 ¹ (15W LED / 3500K / 90 CRI / 1780lm)	RD (Red)	RD (Red)		
	LED1540 ¹ (15W LED / 4000K / 90 CRI / 1860lm)	SA (Satin Aluminum)	SA (Satin Aluminum)		
		SGR (Sage Green)	SGR (Sage Green)		
		SGW (Semi Gloss White)	SGW (Semi Gloss White)		
	SND (Sand)	SND (Sand)			
	SS (Satin Silver)	SS (Satin Silver)			
	TBZ (Textured Bronze)	TBZ (Textured Bronze)			
	TGP (Textured Graphite)	TGP (Textured Graphite)			
	TNG (Tangerine)	TNG (Tangerine)			
	TTL (Tahitian Teal)	TTL (Tahitian Teal)			
	WT (Gloss White)	WT (Gloss White)			

1. Lamp/LED included
2. Not for use in glass/cast guard/wire cage

4. Satin aluminum cannot be coated



Compatible Mounts - see pages 56-58 for detailed specs

Arm Mount Order Matrix (Example: 3LC18SGW)

Pipe Size	Arm Type	Finish	Coastal Coating	Input Voltage
2 (1/2" IP)	SL23 (Small Loop - 23")	(Specify finish - see available finishes on right)	(blank) (No coating)	(blank) (120V)
3 (3/4" IP)	SL30 (Small Loop - 30")		-C ⁴ (Coating)	-27 (277V)
	LL23 (Large Loop - 23")			
	LL30 (Large Loop - 30")			
	LC18 (Curve Arm - 18")			
	LC24 (Curve Arm - 24")			
	LC30 (Curve Arm - 30")			
	LM18 (Miter Arm - 18")			
	LM24 (Miter Arm - 24")			
	LM30 (Miter Arm - 30")			
	SA18 (Sign Arm - 18")			
	SA23 (Sign Arm - 23")			
	LSA23 (Large Loop Sign Arm - 23")			
	LSA30 (Large Loop Sign Arm - 30")			
	A6 (Straight Arm - 6")			
	A12 (Straight Arm - 12")			
	A18 (Straight Arm - 18")			
	A24 (Straight Arm - 24")			
	A30 (Straight Arm - 30")			
	MA18 (Modern Arm - 18")			
	MA24 (Modern Arm - 24")			
	MA30 (Modern Arm - 30")			

4. Satin aluminum cannot be coated

Knuckle Accessory Order Matrix (Example: 2KNLSGW)

Pipe Size	Knuckle	Finish	Coastal Coating
2 (1/2" IP)	KNL (Adjustable 180° Knuckle for Arm Mounts)	(Specify finish - see available finishes on right)	(blank) (No coating)
3 (3/4" IP)			-C ⁴ (Coating)

4. Satin aluminum cannot be coated

Post / Wall Mount Order Matrix (Example: 2W1SGW)

Pipe Size	Mount Type	Finish	Input Voltage
2 (1/2" IP)	P1 (Single Post Mount)	(Specify finish - see available finishes on right)	(blank) (120V)
	P2 (Double Post Mount)		-27 ⁵ (277V)
	W1 (Traditional Wall Mount)		

5. Post mount only























Post Type Order Matrix (Example: P8683-96SGW)

Post Type	Finish
PM4946 (Cast Aluminum Post)	(Specify finish - see available finishes on right)
P8683-96 (Cast Aluminum Base w/ 96" Aluminum Post)	
P8683-120 (Cast Aluminum Base w/ 120" Aluminum Post)	
P8684-96 (96" Straight Aluminum Post)	
P8684-120 (120" Straight Aluminum Post)	
PM8685 (Cast Aluminum Pier Mount - must be used with straight aluminum post, P8683)	

Stem Mount Order Matrix (Example: 2HS18SGW)

Pipe Size	Stem Length	Finish	Coastal Coating
2 (1/2" IP)	HS12 (12")	(Specify finish - see available finishes on right)	(blank) (No coating)
	HS18 (18")		-C ⁴ (Coating)
	HS24 (24")		
	HS36 (36")		
	HS48 (48")		
	HS__ (Custom length from 2" up to 60")		

4. Satin aluminum cannot be coated

Finishes	
	ABL (Aegean Blue)
	BB (Burnished Bronze)
	BK (Gloss Black)
	BLU (Blue)
	DVG (Dove Gray)
	FLG (Flannel Gray)
	GA ^{6,7} (Galvanized)
	LG (Lime Green)
	MB (Matte Black)
	MBL (Midnight Blue)
	PNA (Painted Natural Aluminum)
	PNC (Painted Natural Copper)
	RD (Red)
	SA ^{4,6,7} (Satin Aluminum)
	SGR (Sage Green)
	SGW (Semi Gloss White)
	SND (Sand)
	SS (Satin Silver)
	TBZ (Textured Bronze)
	TGP (Textured Graphite)
	TNG (Tangerine)
	TTL (Tahitian Teal)
	WT (Gloss White)

4. Satin aluminum cannot be coastal coated
 6. Post mount cannot be painted with specialty finishes
 7. Specialty Finish



BIRD CAGE

Electrical

- 120V input (277V available in arm and post option only)
- Integrated power supply allows the fixture to be connected directly into line voltage
- Pre-wired and ready for install
- LED is dimmable with Incandescent/Triac dimmers

Mounting

- 1/2" or 3/4" IP for arms. Flush mount, stems and post available only in 1/2", see next page
- 9' Pendant cord available in black or white cord (includes 5" canopy with the same finish as the shade)

Finishes

- Two-toned shade and outer wire cage
- Available in 21 standard and 2 specialty finishes with optional coastal coating to protect finish in coastal environments (add "-C" to the finish)
- Inner shade is painted gloss white
- Consult factory for custom finish options

Optional Accessories

- Glass, Cast Guard, or Wire Cage options available, see page 57

Listing

UL listed to US and Canadian standards for wet locations



BC14MTBZRD-CGG-2 / 2HS18RD

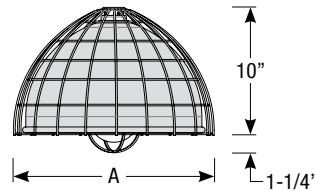

	A
BC14	14"
BC16	16"
BC18	18"

Bird Cage Order Matrix (Example: BC14MTBZRD-CGG-3)

Diameter	Lamp / LED	Shade Finish	Outer Cage Finish	Coastal Coating	Accessories	Mounting Type
BC14 (14")	M (Medium Base, 100W max.)	ABL (Aegean Blue)	ABL	(blank) (No coating)	(blank) (No accessories)	-2 (1/2" IP)
BC16 (16")	GU2413 ¹ (13W GU24 / 2700K)	BB (Burnished Bronze)	BB	-C ⁴ (Coating)	-CG (Clear Glass)	-3 (3/4" IP)
BC18 (18")	GU2418 ¹ (18W GU24 / 2700K)	BK (Gloss Black)	BK		-FG (Frosted Glass)	-B (Black Cord Pendant)
	GU2426 ¹ (26W GU24 / 2700K)	BLU (Blue)	BLU		-OG (Opal Glass)	
	GU2432 ^{1,2} (32W GU24 / 2700K)	DVG (Dove Gray)	DVG		-CGG (Clear Glass w/ Cast Guard)	-W (White Cord Pendant)
	GU2442 ^{1,2} (42W GU24 / 2700K)	FLG (Flannel Gray)	FLG		-FGG (Frosted Glass w/ Cast Guard)	-F (Flush Mount)
	LED1127 ^{1,3} (11W LED / 2700K / 90 CRI / 1188lm)	GA (Galvanized)	GA		-OGG (Opal Glass w/ Cast Guard)	
	LED1130 ^{1,3} (11W LED / 3000K / 90 CRI / 1265lm)	LG (Lime Green)	LG		-CGWC (Clear Glass w/ Wire Cage)	
	LED1135 ^{1,3} (11W LED / 3500K / 90 CRI / 1305lm)	MB (Matte Black)	MB		-FGWC (Frosted Glass w/ Wire Cage)	
	LED1140 ^{1,3} (11W LED / 4000K / 90 CRI / 1364lm)	MBL (Midnight Blue)	MBL		-OGWC (Opal Glass w/ Wire Cage)	
	LED1527 ^{1,3} (15W LED / 2700K / 90 CRI / 1620lm)	PNA (Painted Natural Aluminum)	PNA			
	LED1530 ^{1,3} (15W LED / 3000K / 90 CRI / 1725lm)	PNC (Painted Natural Copper)	PNC			
	LED1535 ^{1,3} (15W LED / 3500K / 90 CRI / 1780lm)	RD (Red)	RD			
	LED1540 ^{1,3} (15W LED / 4000K / 90 CRI / 1860lm)	SA (Satin Aluminum)	SA			
		SGR (Sage Green)	SGR			
		SGW (Semi Gloss White)	SGW			
		SND (Sand)	SND			
	SS (Satin Silver)	SS				
	TBZ (Textured Bronze)	TBZ				
	TGP (Textured Graphite)	TGP				
	TNG (Tangerine)	TNG				
	TTL (Tahitian Teal)	TTL				
	WT (Gloss White)	WT				

1. Lamp/LED included
 2. Not for use in glass/cast guard/wire cage
 3. Glass enclosure must be specified

4. Satin aluminum cannot be coated



Compatible Mounts - see pages 56-58 for detailed specs



Arm Mount Order Matrix (Example: 3SL23RD)

Pipe Size	Arm Type	Finish	Coastal Coating	Input Voltage
2 (1/2" IP)	SL23 (Small Loop - 23")	(Specify finish - see available finishes on right)	(blank) (No coating)	(blank) (120V)
3 (3/4" IP)	SL30 (Small Loop - 30")		-C ⁴ (Coating)	-27 (277V)
	LL23 (Large Loop - 23")			
	LL30 (Large Loop - 30")			
	LC18 (Curve Arm - 18")			
	LC24 (Curve Arm - 24")			
	LC30 (Curve Arm - 30")			
	LM18 (Miter Arm - 18")			
	LM24 (Miter Arm - 24")			
	LM30 (Miter Arm - 30")			
	SA18 (Sign Arm - 18")			
	SA23 (Sign Arm - 23")			
	LSA23 (Large Loop Sign Arm - 23")			
	LSA30 (Large Loop Sign Arm - 30")			
	A6 (Straight Arm - 6")			
	A12 (Straight Arm - 12")			
	A18 (Straight Arm - 18")			
	A24 (Straight Arm - 24")			
	A30 (Straight Arm - 30")			
	MA18 (Modern Arm - 18")			
	MA24 (Modern Arm - 24")			
	MA30 (Modern Arm - 30")			

4. Satin aluminum cannot be coated

Knuckle Accessory Order Matrix (Example: 2KNLRD)

Pipe Size	Knuckle	Finish	Coastal Coating
2 (1/2" IP)	KNL (Adjustable 180° Knuckle for Arm Mounts)	(Specify finish - see available finishes on right)	(blank) (No coating)
3 (3/4" IP)			-C ⁴ (Coating)

4. Satin aluminum cannot be coated

Post / Wall Mount Order Matrix (Example: 2W1RD)

Pipe Size	Mount Type	Finish	Input Voltage
2 (1/2" IP)	P1 (Single Post Mount)	(Specify finish - see available finishes on right)	(blank) (120V)
	P2 (Double Post Mount)		-27 ⁵ (277V)
	W1 (Traditional Wall Mount)		

5. Post mount only

Post Type Order Matrix (Example: P8683-96RD)

Post Type	Finish
PM4946 (Cast Aluminum Post)	(Specify finish - see available finishes on right)
P8683-96 (Cast Aluminum Base w/ 96" Aluminum Post)	
P8683-120 (Cast Aluminum Base w/ 120" Aluminum Post)	
P8684-96 (96" Straight Aluminum Post)	
P8684-120 (120" Straight Aluminum Post)	
PM8685 (Cast Aluminum Pier Mount - must be used with straight aluminum post, P8683)	

Stem Mount Order Matrix (Example: 2HS18RD)

Pipe Size	Stem Length	Finish	Coastal Coating
2 (1/2" IP)	HS12 (12")	(Specify finish - see available finishes on right)	(blank) (No coating)
	HS18 (18")		-C ⁴ (Coating)
	HS24 (24")		
	HS36 (36")		
	HS48 (48")		
	HS__ (Custom length from 2" up to 60")		

4. Satin aluminum cannot be coated

Finishes	
	ABL (Aegean Blue)
	BB (Burnished Bronze)
	BK (Gloss Black)
	BLU (Blue)
	DVG (Dove Gray)
	FLG (Flannel Gray)
	GA^{6,7} (Galvanized)
	LG (Lime Green)
	MB (Matte Black)
	MBL (Midnight Blue)
	PNA (Painted Natural Aluminum)
	PNC (Painted Natural Copper)
	RD (Red)
	SA^{4,6,7} (Satin Aluminum)
	SGR (Sage Green)
	SGW (Semi Gloss White)
	SND (Sand)
	SS (Satin Silver)
	TBZ (Textured Bronze)
	TGP (Textured Graphite)
	TNG (Tangerine)
	TTL (Tahitian Teal)
	WT (Gloss White)

4. Satin aluminum cannot be coastal coated
6. Post mount cannot be painted with specialty finishes
7. Specialty Finish



CLASSIC

Electrical

- 120V input (277V available, must specify on arm mount)
- Integrated power supply allows the fixture to be connected directly into line voltage
- Pre-wired and ready for install
- Dimmable with Incandescent/Triac dimmers

Mounting

- 3/4" IP for arm mount options, see next page

Finishes

- Shade and mounting finish options
- Available in 21 standard and 2 specialty finishes with optional coastal coating to protect finish in coastal environments (add "-C" to the finish)
- Consult factory for custom finish options

Listing

UL listed to US and Canadian standards for wet locations



CL24LED25GA-3 / 3LLA23GA

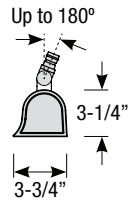
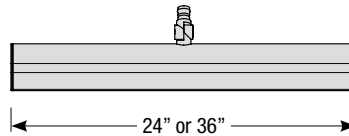

Classic Order Matrix (Example: CL24LED25GA-3)

Length	LED Light Engine	Finish	Coastal Coating	Pipe
CL24 (24")	LED25 ¹ (25W LED / 2850K / 80 CRI / 1750lm - CL24 only)	ABL (Aegean Blue)	(blank) (No coating)	-3 (3/4" IP)
CL36 (36")	LED33 ¹ (33W LED / 2850K / 80 CRI / 2300lm - CL36 only)	BB (Burnished Bronze)	-C ² (Coating)	
		BK (Gloss Black)		
		BLU (Blue)		
		DVG (Dove Gray)		
		FLG (Flannel Gray)		
		GA (Galvanized)		
		LG (Lime Green)		
		MB (Matte Black)		
		MBL (Midnight Blue)		
		PNA (Painted Natural Aluminum)		
		PNC (Painted Natural Copper)		
		RD (Red)		
		SA (Satin Aluminum)		
		SGR (Sage Green)		
		SGW (Semi Gloss White)		
		SND (Sand)		
		SS (Satin Silver)		
		TBZ (Textured Bronze)		
		TGP (Textured Graphite)		
		TNG (Tangerine)		
		TTL (Tahitian Teal)		
		WT (Gloss White)		

1. Lamp/LED included

2. Satin aluminum cannot be coated



Compatible Mounts

Arm Mount Order Matrix (Example: 3LLA23GA)

Pipe Size	Arm Type	Finish	Coastal Coating	Input Voltage
3 (3/4" IP)	SLA23 (Small Loop - 23")	(Specify finish - see available finishes on right)	(blank) (No coating)	(blank) (120V)
	SLA30 (Small Loop - 30")		-C ² (Coating)	-27 (277V)
	LLA23 (Large Loop - 23")			
	LLA30 (Large Loop - 30")			
	LCA18 (Curve Arm - 18")			
	LCA24 (Curve Arm - 24")			
	LCA30 (Curve Arm - 30")			
	LMA18 (Miter Arm - 18")			
	LMA24 (Miter Arm - 24")			
	LMA30 (Miter Arm - 30")			
	SAA18 (Sign Arm - 18")			
	SAA23 (Sign Arm - 23")			
	LSAA23 (Large Loop Sign Arm - 23")			
	LSAA30 (Large Loop Sign Arm - 30")			
MAA18 (Modern Arm - 18")				
MAA24 (Modern Arm - 24")				
MAA30 (Modern Arm - 30")				

2. Satin aluminum cannot be coated

Finishes	
	ABL (Aegean Blue)
	BB (Burnished Bronze)
	BK (Gloss Black)
	BLU (Blue)
	DVG (Dove Gray)
	FLG (Flannel Gray)
	GA³ (Galvanized)
	LG (Lime Green)
	MB (Matte Black)
	MBL (Midnight Blue)
	PNA (Painted Natural Aluminum)
	PNC (Painted Natural Copper)
	RD (Red)
	SA^{2,3} (Satin Aluminum)
	SGR (Sage Green)
	SGW (Semi Gloss White)
	SND (Sand)
	SS (Satin Silver)
	TBZ (Textured Bronze)
	TGP (Textured Graphite)
	TNG (Tangerine)
	TTL (Tahitian Teal)
	WT (Gloss White)

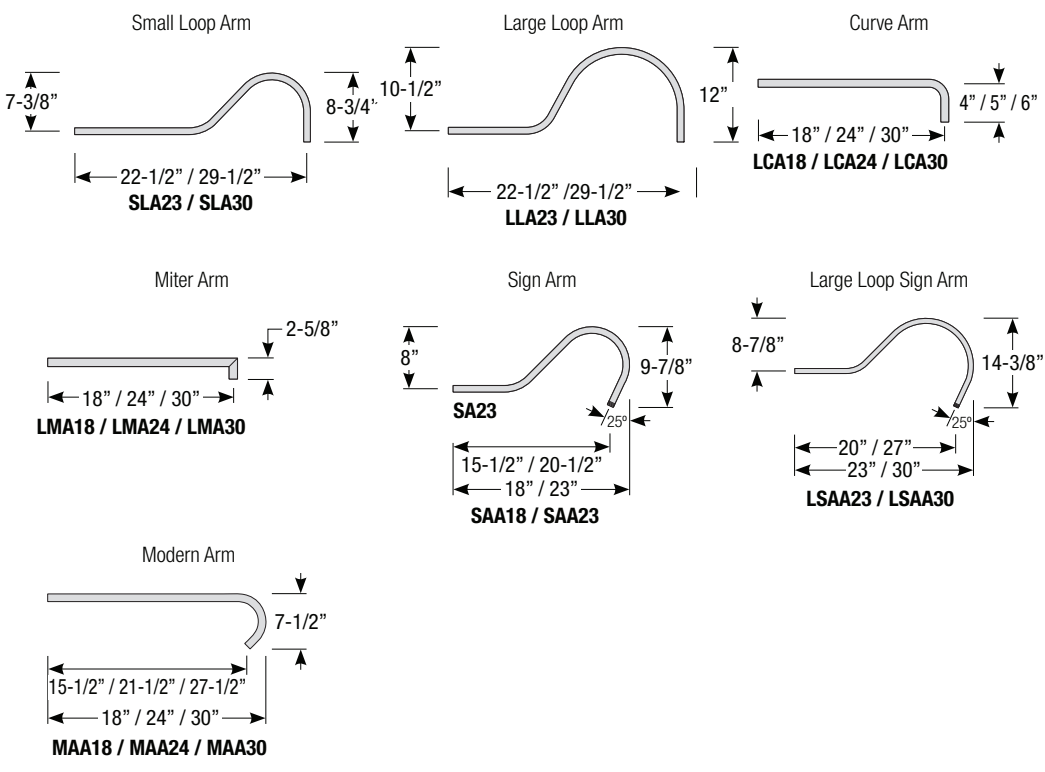

Note: All arm mounts include canopy

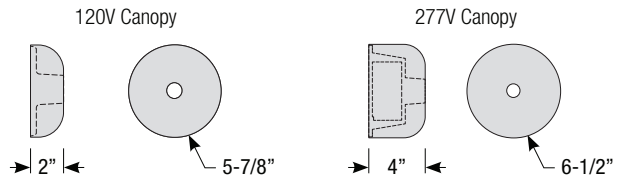

2. Satin aluminum cannot be coastal coated
 3. Specialty Finish

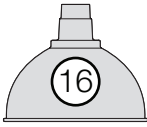

DEEP REFLECTOR

Electrical

- 120V input (277V available in arm and post option only)
- Integrated power supply allows the fixture to be connected directly into line voltage
- Pre-wired and ready for install
- LED is dimmable with Incandescent/Triac dimmers

Mounting

- 1/2" or 3/4" IP for arms. Flush mount, stems and post available only in 1/2", see next page
- 9' Pendant cord available in black or white cord (includes 5" canopy with the same finish as the shade)

Finishes

- Shade and mounting finish options
- Available in 21 standard and 2 specialty finishes with optional coastal coating to protect finish in coastal environments (add "-C" to the finish)
- Inner shade is painted gloss white
- Consult factory for custom finish options

Optional Accessories

- Glass, Cast Guard, Wire Cage or Wire Guard options available, see page 57

Listing

UL listed to US and Canadian standards for wet locations



RD14GU2426MBL-WG-2 / 2LL30MBL

RD14GU2426GA-3 / 3LL23GA

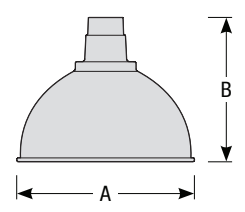

	A	B
RD10	10"	10"
RD12	12"	12"
RD14	14"	14"
RD16	16"	14"

Deep Reflector Order Matrix (Example: RD14GU2426MBL-WG-2)

Diameter	Lamp / LED	Finish	Coastal Coating	Accessories	Mounting Type
RD10 (10")	M (Medium Base, 100W max.)	ABL (Aegean Blue)	(blank) (No coating)	(blank) (No accessories)	-2 (1/2" IP)
RD12 (12")	GU2413 ¹ (13W GU24 / 2700K)	BB (Burnished Bronze)	-C ⁴ (Coating)	-CG (Clear Glass)	-3 (3/4" IP)
RD14 (14")	GU2418 ¹ (18W GU24 / 2700K)	BK (Gloss Black)		-FG (Frosted Glass)	-B (Black Cord Pendant)
RD16 (16")	GU2426 ¹ (26W GU24 / 2700K)	BLU (Blue)		-OG (Opal Glass)	-W (White Cord Pendant)
	GU2432 ^{1,2} (32W GU24 / 2700K)	DVG (Dove Gray)		-CGG (Clear Glass w/ Cast Guard)	-W (White Cord Pendant)
	GU2442 ^{1,2} (42W GU24 / 2700K)	FLG (Flannel Gray)		-FGG (Frosted Glass w/ Cast Guard)	-F (Flush Mount)
	LED1127 ^{1,3} (11W LED / 2700K / 90 CRI / 1188lm)	GA (Galvanized)		-OGG (Opal Glass w/ Cast Guard)	
	LED1130 ^{1,3} (11W LED / 3000K / 90 CRI / 1265lm)	LG (Lime Green)		-CGWC (Clear Glass w/ Wire Cage)	
	LED1135 ^{1,3} (11W LED / 3500K / 90 CRI / 1305lm)	MB (Matte Black)		-FGWC (Frosted Glass w/ Wire Cage)	
	LED1140 ^{1,3} (11W LED / 4000K / 90 CRI / 1364lm)	MBL (Midnight Blue)		-OGWC (Opal Glass w/ Wire Cage)	
	LED1527 ^{1,3} (15W LED / 2700K / 90 CRI / 1620lm)	PNA (Painted Natural Aluminum)		-WG (Wire Guard)	
	LED1530 ^{1,3} (15W LED / 3000K / 90 CRI / 1725lm)	PNC (Painted Natural Copper)			
	LED1535 ^{1,3} (15W LED / 3500K / 90 CRI / 1780lm)	RD (Red)			
	LED1540 ^{1,3} (15W LED / 4000K / 90 CRI / 1860lm)	SA (Satin Aluminum)			
		SGR (Sage Green)			
		SGW (Semi Gloss White)			
		SND (Sand)			
		SS (Satin Silver)			
		TBZ (Textured Bronze)			
		TGP (Textured Graphite)			
		TNG (Tangerine)			
		TTL (Tahitian Teal)			
		WT (Gloss White)			

1. Lamp/LED included
 2. Not for use in glass/cast guard/wire cage
 3. Glass enclosure must be specified

4. Satin aluminum cannot be coated



Compatible Mounts - see pages 56-58 for detailed specs

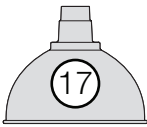

Arm Mount Order Matrix (Example: 2LL30MBL)

Pipe Size	Arm Type	Finish	Coastal Coating	Input Voltage	
2 (1/2" IP)	SL23 (Small Loop- 23")	(Specify finish - see available finishes on right)	(blank) (No coating)	(blank) (120V)	
3 (3/4" IP)	SL30 (Small Loop- 30")		-C ⁴ (Coating)	-27 (277V)	
	LL23 (Large Loop - 23")				
	LL30 (Large Loop - 30")				
	LC18 (Curve Arm - 18")				
	LC24 (Curve Arm - 24")				
	LC30 (Curve Arm - 30")				
	LM18 (Miter Arm - 18")				
	LM24 (Miter Arm - 24")				
	LM30 (Miter Arm - 30")				
	SA18 (Sign Arm - 18")				
	SA23 (Sign Arm - 23")				
	LSA23 (Large Loop Sign Arm - 23")				
	LSA30 (Large Loop Sign Arm - 30")				
	A6 (Straight Arm - 6")				
	A12 (Straight Arm - 12")				
	A18 (Straight Arm - 18")				
	A24 (Straight Arm - 24")				
	A30 (Straight Arm - 30")				
	MA18 (Modern Arm - 18")				
	MA24 (Modern Arm - 24")				
	MA30 (Modern Arm - 30")				

4. Satin aluminum cannot be coated

Knuckle Accessory Order Matrix (Example: 2KNLMBL)

Pipe Size	Knuckle	Finish	Coastal Coating
2 (1/2" IP)	KNL (Adjustable 180° Knuckle for Arm Mounts)	(Specify finish - see available finishes on right)	(blank) (No coating)
3 (3/4" IP)			-C ⁴ (Coating)

4. Satin aluminum cannot be coated

Post / Wall Mount Order Matrix (Example: 2W1MBL)

Pipe Size	Mount Type	Finish	Input Voltage
2 (1/2" IP)	P1 (Single Post Mount)	(Specify finish - see available finishes on right)	(blank) (120V)
	P2 (Double Post Mount)		-27 ⁵ (277V)
	W1 (Traditional Wall Mount)		

5. Post mount only

Post Type Order Matrix (Example: P8683-96MBL)

Post Type	Finish
PM4946 (Cast Aluminum Post)	(Specify finish - see available finishes on right)
P8683-96 (Cast Aluminum Base w/ 96" Aluminum Post)	
P8683-120 (Cast Aluminum Base w/ 120" Aluminum Post)	
P8684-96 (96" Straight Aluminum Post)	
P8684-120 (120" Straight Aluminum Post)	
PM8685 (Cast Aluminum Pier Mount - must be used with straight aluminum post, P8683)	

Stem Mount Order Matrix (Example: 2HS18MBL)

Pipe Size	Stem Length	Finish	Coastal Coating
2 (1/2" IP)	HS12 (12")	(Specify finish - see available finishes on right)	(blank) (No coating)
	HS18 (18")		-C ⁴ (Coating)
	HS24 (24")		
	HS36 (36")		
	HS48 (48")		
	HS__ (Custom length from 2" up to 60")		

4. Satin aluminum cannot be coated

Finishes	
	ABL (Aegean Blue)
	BB (Burnished Bronze)
	BK (Gloss Black)
	BLU (Blue)
	DVG (Dove Gray)
	FLG (Flannel Gray)
	GA^{6,7} (Galvanized)
	LG (Lime Green)
	MB (Matte Black)
	MBL (Midnight Blue)
	PNA (Painted Natural Aluminum)
	PNC (Painted Natural Copper)
	RD (Red)
	SA^{4,6,7} (Satin Aluminum)
	SGR (Sage Green)
	SGW (Semi Gloss White)
	SND (Sand)
	SS (Satin Silver)
	TBZ (Textured Bronze)
	TGP (Textured Graphite)
	TNG (Tangerine)
	TTL (Tahitian Teal)
	WT (Gloss White)

4. Satin aluminum cannot be coastal coated
 6. Post mount cannot be painted with specialty finishes
 7. Specialty Finish

DOME

Electrical

- 120V input (277V available in arm and post option only)
- Integrated power supply allows the fixture to be connected directly into line voltage
- Pre-wired and ready for install
- LED is dimmable with Incandescent/ Triac dimmers

Mounting

- 1/2" or 3/4" IP for arms. Flush mount, stems and post available only in 1/2", see next page
- 9' Pendant cord available in black or white cord (includes 5" canopy with the same finish as the shade)

Finishes

- Two-toned shade and lens ring finish options
- Available in 21 standard and 2 specialty finishes with optional coastal coating to protect finish in coastal environments (add "-C" to the finish)
- Consult factory for custom finish options

Listing

UL listed to US and Canadian standards for wet locations

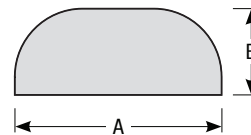

	A	B
DM12	12"	5"
DM14	14"	5-7/8"
DM16	16"	6-5/8"

Dome Order Matrix (Example: DM16LED1127SNDWT-B)

Diameter	Lamp / LED	Shade Finish	Lens Ring Finish	Coastal Coating	Mounting Type
DM12 (12")	M (Medium Base, 100W max.)	ABL (Aegean Blue)	ABL (Aegean Blue)	(blank) (No coating)	-2 (1/2" IP)
DM14 (14")	GU2413¹ (13W GU24 / 2700K)	BB (Burnished Bronze)	BB (Burnished Bronze)	-C² (Coating)	-3 (3/4" IP)
DM16 (16")	GU2418¹ (18W GU24 / 2700K)	BK (Gloss Black)	BK (Gloss Black)		-B (Black Cord Pendant)
	GU2426¹ (26W GU24 / 2700K)	BLU (Blue)	BLU (Blue)		-W (White Cord Pendant)
	GU2432¹ (32W GU24 / 2700K)	DVG (Dove Gray)	DVG (Dove Gray)		-F (Flush Mount)
	GU2442¹ (42W GU24 / 2700K)	FLG (Flannel Gray)	FLG (Flannel Gray)		
	LED1127¹ (11W LED / 2700K / 90 CRI / 1188lm)	GA (Galvanized)	GA (Galvanized)		
	LED1130¹ (11W LED / 3000K / 90 CRI / 1265lm)	LG (Lime Green)	LG (Lime Green)		
	LED1135¹ (11W LED / 3500K / 90 CRI / 1305lm)	MB (Matte Black)	MB (Matte Black)		
	LED1140¹ (11W LED / 4000K / 90 CRI / 1364lm)	MBL (Midnight Blue)	MBL (Midnight Blue)		
	LED1527¹ (15W LED / 2700K / 90 CRI / 1620lm)	PNA (Painted Natural Aluminum)	PNA (Painted Natural Aluminum)		
	LED1530¹ (15W LED / 3000K / 90 CRI / 1725lm)	PNC (Painted Natural Copper)	PNC (Painted Natural Copper)		
	LED1535¹ (15W LED / 3500K / 90 CRI / 1780lm)	RD (Red)	RD (Red)		
	LED1540¹ (15W LED / 4000K / 90 CRI / 1860lm)	SA (Satin Aluminum)	SA (Satin Aluminum)		
		SGR (Sage Green)	SGR (Sage Green)		
		SGW (Semi Gloss White)	SGW (Semi Gloss White)		
	SND (Sand)	SND (Sand)			
	SS (Satin Silver)	SS (Satin Silver)			
	TBZ (Textured Bronze)	TBZ (Textured Bronze)			
	TGP (Textured Graphite)	TGP (Textured Graphite)			
	TNG (Tangerine)	TNG (Tangerine)			
	TTL (Tahitian Teal)	TTL (Tahitian Teal)			
	WT (Gloss White)	WT (Gloss White)			

1. Lamp/LED included

2. Satin aluminum cannot be coated



Compatible Mounts - see pages 56-58 for detailed specs

Arm Mount Order Matrix (Example: 3LM18TTL)

Pipe Size	Arm Type	Finish	Coastal Coating	Input Voltage
2 (1/2" IP)	SL23 (Small Loop- 23")	(Specify finish - see available finishes on right)	(blank) (No coating)	(blank) (120V)
3 (3/4" IP)	SL30 (Small Loop- 30")		-C ² (Coating)	-27 (277V)
	LL23 (Large Loop - 23")			
	LL30 (Large Loop - 30")			
	LC18 (Curve Arm - 18")			
	LC24 (Curve Arm - 24")			
	LC30 (Curve Arm - 30")			
	LM18 (Miter Arm - 18")			
	LM24 (Miter Arm - 24")			
	LM30 (Miter Arm - 30")			
	SA18 (Sign Arm - 18")			
	SA23 (Sign Arm - 23")			
	LSA23 (Large Loop Sign Arm - 23")			
	LSA30 (Large Loop Sign Arm - 30")			
	A6 (Straight Arm - 6")			
	A12 (Straight Arm - 12")			
	A18 (Straight Arm - 18")			
	A24 (Straight Arm - 24")			
	A30 (Straight Arm - 30")			
	MA18 (Modern Arm - 18")			
	MA24 (Modern Arm - 24")			
	MA30 (Modern Arm - 30")			

2. Satin aluminum cannot be coated

Knuckle Accessory Order Matrix (Example: 2KNLTTL)

Pipe Size	Knuckle	Finish	Coastal Coating
2 (1/2" IP)	KNL (Adjustable 180° Knuckle for Arm Mounts)	(Specify finish - see available finishes on right)	(blank) (No coating)
3 (3/4" IP)			-C ² (Coating)

2. Satin aluminum cannot be coated

Post / Wall Mount Order Matrix (Example: 2P1TTL)

Pipe Size	Mount Type	Finish	Input Voltage
2 (1/2" IP)	P1 (Single Post Mount)	(Specify finish - see available finishes on right)	(blank) (120V)
	P2 (Double Post Mount)		-27 ³ (277V)
	W1 (Traditional Wall Mount)		

3. Post mount only























Post Type Order Matrix (Example: P8683-96TTL)

Post Type	Finish
PM4946 (Cast Aluminum Post)	(Specify finish - see available finishes on right)
P8683-96 (Cast Aluminum Base w/ 96" Aluminum Post)	
P8683-120 (Cast Aluminum Base w/ 120" Aluminum Post)	
P8684-96 (96" Straight Aluminum Post)	
P8684-120 (120" Straight Aluminum Post)	
PM8685 (Cast Aluminum Pier Mount - must be used with straight aluminum post, P8683)	

Stem Mount Order Matrix (Example: 2HS36TTL)

Pipe Size	Stem Length	Finish	Coastal Coating
2 (1/2" IP)	HS12 (12")	(Specify finish - see available finishes on right)	(blank) (No coating)
	HS18 (18")		-C ² (Coating)
	HS24 (24")		
	HS36 (36")		
	HS48 (48")		
	HS__ (Custom length from 2" up to 60")		

2. Satin aluminum cannot be coated

Finishes	
	ABL (Aegean Blue)
	BB (Burnished Bronze)
	BK (Gloss Black)
	BLU (Blue)
	DVG (Dove Gray)
	FLG (Flannel Gray)
	GA ^{4,5} (Galvanized)
	LG (Lime Green)
	MB (Matte Black)
	MBL (Midnight Blue)
	PNA (Painted Natural Aluminum)
	PNC (Painted Natural Copper)
	RD (Red)
	SA ^{2,4,5} (Satin Aluminum)
	SGR (Sage Green)
	SGW (Semi Gloss White)
	SND (Sand)
	SS (Satin Silver)
	TBZ (Textured Bronze)
	TGP (Textured Graphite)
	TNG (Tangerine)
	TTL (Tahitian Teal)
	WT (Gloss White)

2. Satin aluminum cannot be coastal coated
 4. Post mount cannot be painted with specialty finishes
 5. Specialty Finish

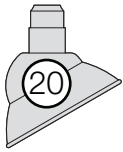

EMBLEM

Electrical

- 120V input (277V available in arm and post option only)
- Integrated power supply allows the fixture to be connected directly into line voltage
- Pre-wired and ready for install
- LED is dimmable with Incandescent/Triac dimmers

Mounting

- 1/2" or 3/4" IP for arms. Flush mount and post available only in 1/2", see next page

Finishes

- Shade and mounting finish options
- Available in 21 standard and 2 specialty finishes with optional coastal coating to protect finish in coastal environments (add "-C" to the finish)
- Inner shade is painted gloss white
- Consult factory for custom finish options

Optional Accessories

- Glass, Cast Guard, Wire Cage or Wire Guard options available, see page 57

Listing

UL listed to US and Canadian standards for wet locations



RE10LED1127MB-3 / 3A24MB

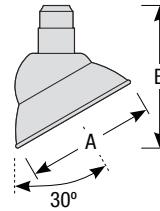

	A	B
RE8	8"	9-3/8"
RE10	10"	11-5/8"
RE12	12"	13"

Emblem Order Matrix (Example: RE10LED1127MB-3)

Diameter	Lamp / LED	Finish	Coastal Coating	Accessories	Mounting Type
RE8 (8")	M (Medium Base, 100W max.)	ABL (Aegean Blue)	(blank) (No coating)	(blank) (No accessories)	-2 (1/2" IP)
RE10 (10")	GU2413 ¹ (13W GU24 / 2700K)	BB (Burnished Bronze)	-C ⁴ (Coating)	-CG (Clear Glass)	-3 (3/4" IP)
RE12 (12")	GU2418 ¹ (18W GU24 / 2700K)	BK (Gloss Black)		-FG (Frosted Glass)	-F (Flush Mount)
	GU2426 ¹ (26W GU24 / 2700K)	BLU (Blue)		-OG (Opal Glass)	
	GU2432 ^{1,2} (32W GU24 / 2700K)	DVG (Dove Gray)		-CGG (Clear Glass w/ Cast Guard)	
	GU2442 ^{1,2} (42W GU24 / 2700K)	FLG (Flannel Gray)		-FGG (Frosted Glass w/ Cast Guard)	
	LED1127 ^{1,3} (11W LED / 2700K / 90 CRI / 1188lm)	GA (Galvanized)		-OGG (Opal Glass w/ Cast Guard)	
	LED1130 ^{1,3} (11W LED / 3000K / 90 CRI / 1265lm)	LG (Lime Green)		-CGWC (Clear Glass w/ Wire Cage)	
	LED1135 ^{1,3} (11W LED / 3500K / 90 CRI / 1305lm)	MB (Matte Black)		-FGWC (Frosted Glass w/ Wire Cage)	
	LED1140 ^{1,3} (11W LED / 4000K / 90 CRI / 1364lm)	MBL (Midnight Blue)		-OGWC (Opal Glass w/ Wire Cage)	
	LED1527 ^{1,3} (15W LED / 2700K / 90 CRI / 1620lm)	PNA (Painted Natural Aluminum)		-WG (Wire Guard)	
	LED1530 ^{1,3} (15W LED / 3000K / 90 CRI / 1725lm)	PNC (Painted Natural Copper)			
	LED1535 ^{1,3} (15W LED / 3500K / 90 CRI / 1780lm)	RD (Red)			
	LED1540 ^{1,3} (15W LED / 4000K / 90 CRI / 1860lm)	SA (Satin Aluminum)			
		SGR (Sage Green)			
		SGW (Semi Gloss White)			
		SND (Sand)			
		SS (Satin Silver)			
		TBZ (Textured Bronze)			
		TGP (Textured Graphite)			
		TNG (Tangerine)			
		TTL (Tahitian Teal)			
		WT (Gloss White)			

1. Lamp/LED included
 2. Not for use in glass/cast guard/wire cage
 3. Glass enclosure must be specified

4. Satin aluminum cannot be coated



Compatible Mounts - see pages 56-58 for detailed specs

Arm Mount Order Matrix

(Example: 3A24MB)

Pipe Size	Arm Type	Finish	Coastal Coating	Input Voltage
2 (1/2" IP)	SL23 (Small Loop - 23")	(Specify finish - see available finishes on right)	(blank) (No coating)	(blank) (120V)
3 (3/4" IP)	SL30 (Small Loop - 30")		-C ⁴ (Coating)	-27 (277V)
	LL23 (Large Loop - 23")			
	LL30 (Large Loop - 30")			
	LC18 (Curve Arm - 18")			
	LC24 (Curve Arm - 24")			
	LC30 (Curve Arm - 30")			
	LM18 (Miter Arm - 18")			
	LM24 (Miter Arm - 24")			
	LM30 (Miter Arm - 30")			
	SA18 (Sign Arm - 18")			
	SA23 (Sign Arm - 23")			
	LSA23 (Large Loop Sign Arm - 23")			
	LSA30 (Large Loop Sign Arm - 30")			
	A6 (Straight Arm - 6")			
	A12 (Straight Arm - 12")			
	A18 (Straight Arm - 18")			
	A24 (Straight Arm - 24")			
	A30 (Straight Arm - 30")			
	MA18 (Modern Arm - 18")			
	MA24 (Modern Arm - 24")			
	MA30 (Modern Arm - 30")			

4. Satin aluminum cannot be coated

Knuckle Accessory Order Matrix (Example: 2KNLMB)

Pipe Size	Knuckle	Finish	Coastal Coating
2 (1/2" IP)	KNL (Adjustable 180° Knuckle for Arm Mounts)	(Specify finish - see available finishes on right)	(blank) (No coating)
3 (3/4" IP)			-C ⁴ (Coating)

4. Satin aluminum cannot be coated

Post / Wall Mount Order Matrix (Example: 2W1MB)

Pipe Size	Mount Type	Finish	Input Voltage
2 (1/2" IP)	P1 (Single Post Mount)	(Specify finish - see available finishes on right)	(blank) (120V)
	P2 (Double Post Mount)		-27 ⁵ (277V)
	W1 (Traditional Wall Mount)		

5. Post mount only

Post Type Order Matrix (Example: P8683-96MB)

Post Type	Finish
PM4946 (Cast Aluminum Post)	(Specify finish - see available finishes on right)
P8683-96 (Cast Aluminum Base w/ 96" Aluminum Post)	
P8683-120 (Cast Aluminum Base w/ 120" Aluminum Post)	
P8684-96 (96" Straight Aluminum Post)	
P8684-120 (120" Straight Aluminum Post)	
PM8685 (Cast Aluminum Pier Mount - must be used with straight aluminum post, P8683)	

Finishes	
	ABL (Aegean Blue)
	BB (Burnished Bronze)
	BK (Gloss Black)
	BLU (Blue)
	DVG (Dove Gray)
	FLG (Flannel Gray)
	GA ^{6,7} (Galvanized)
	LG (Lime Green)
	MB (Matte Black)
	MBL (Midnight Blue)
	PNA (Painted Natural Aluminum)
	PNC (Painted Natural Copper)
	RD (Red)
	SA ^{4,6,7} (Satin Aluminum)
	SGR (Sage Green)
	SGW (Semi Gloss White)
	SND (Sand)
	SS (Satin Silver)
	TBZ (Textured Bronze)
	TGP (Textured Graphite)
	TNG (Tangerine)
	TTL (Tahitian Teal)
	WT (Gloss White)

4. Satin aluminum cannot be coastal coated
 6. Post mount cannot be painted with specialty finishes
 7. Specialty Finish

FRESH

Electrical

- 120/277V input
- Integrated power supply allows the fixture to be connected directly into line voltage
- Pre-wired and ready for install
- Dimmable with 120V Incandescent/Triac/0-10V dimmers

Mounting

- 1/2" IP or 3/4" IP for arms. Stems available only in 1/2", see next page

Finishes

- Two-toned shade and lens ring finish options
- Available in 21 standard and 2 specialty finishes with optional coastal coating to protect finish in coastal environments (add "-C" to the finish)
- Consult factory for custom finish options

Listing

UL listed to US and Canadian standards for wet locations

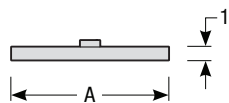

	A
FR12	12"
FR16	16"

Fresh Order Matrix (Example: FR16LED44SGWSGW-3)

Diameter	LED Light Engine	Shade Finish	Lens Ring Finish	Coastal Coating	Pipe
FR12 (12")	LED20 ¹ (20W LED / 2800K / 80 CRI / 1200lm)	ABL (Aegean Blue)	ABL (Aegean Blue)	(blank) (No coating)	-2 (1/2" IP)
FR16 (16")	LED44 ¹ (44W LED / 2800K / 80 CRI / 2800lm - FR16 only)	BB (Burnished Bronze)	BB (Burnished Bronze)	-C ² (Coating)	-3 (3/4" IP)
		BK (Gloss Black)	BK (Gloss Black)		
		BLU (Blue)	BLU (Blue)		
		DVG (Dove Gray)	DVG (Dove Gray)		
		FLG (Flannel Gray)	FLG (Flannel Gray)		
		GA (Galvanized)	GA (Galvanized)		
		LG (Lime Green)	LG (Lime Green)		
		MB (Matte Black)	MB (Matte Black)		
		MBL (Midnight Blue)	MBL (Midnight Blue)		
		PNA (Painted Natural Aluminum)	PNA (Painted Natural Aluminum)		
		PNC (Painted Natural Copper)	PNC (Painted Natural Copper)		
		RD (Red)	RD (Red)		
		SA (Satin Aluminum)	SA (Satin Aluminum)		
		SGR (Sage Green)	SGR (Sage Green)		
		SGW (Semi Gloss White)	SGW (Semi Gloss White)		
		SND (Sand)	SND (Sand)		
		SS (Satin Silver)	SS (Satin Silver)		
		TBZ (Textured Bronze)	TBZ (Textured Bronze)		
		TGP (Textured Graphite)	TGP (Textured Graphite)		
		TNG (Tangerine)	TNG (Tangerine)		
		TTL (Tahitian Teal)	TTL (Tahitian Teal)		
		WT (Gloss White)	WT (Gloss White)		

1. Lamp/LED included

2. Satin aluminum cannot be coated



Compatible Mounts

Arm Mount Order Matrix (Example: 3LMB18SGW)

Pipe Size	Arm Type	Finish	Coastal Coating
2 (1/2" IP)	SLB23 (Small Loop- 23")	(Specify finish - see available finishes on right)	(blank) (No coating) -C ² (Coating)
3 (3/4" IP)	SLB30 (Small Loop- 30")		
	LLB23 (Large Loop - 23")		
	LLB30 (Large Loop - 30")		
	LCB18 (Curve Arm - 18")		
	LCB24 (Curve Arm - 24")		
	LCB30 (Curve Arm - 30")		
	LMB18 (Miter Arm - 18")		
	LMB24 (Miter Arm - 24")		
	LMB30 (Miter Arm - 30")		
	SAB18 (Sign Arm - 18")		
	SAB23 (Sign Arm - 23")		
	LSAB23 (Large Loop Sign Arm - 23")		
	LSAB30 (Large Loop Sign Arm - 30")		
	MAB18 (Modern Arm - 18")		
	MAB24 (Modern Arm - 24")		
	MAB30 (Modern Arm - 30")		

2. Satin aluminum cannot be coated

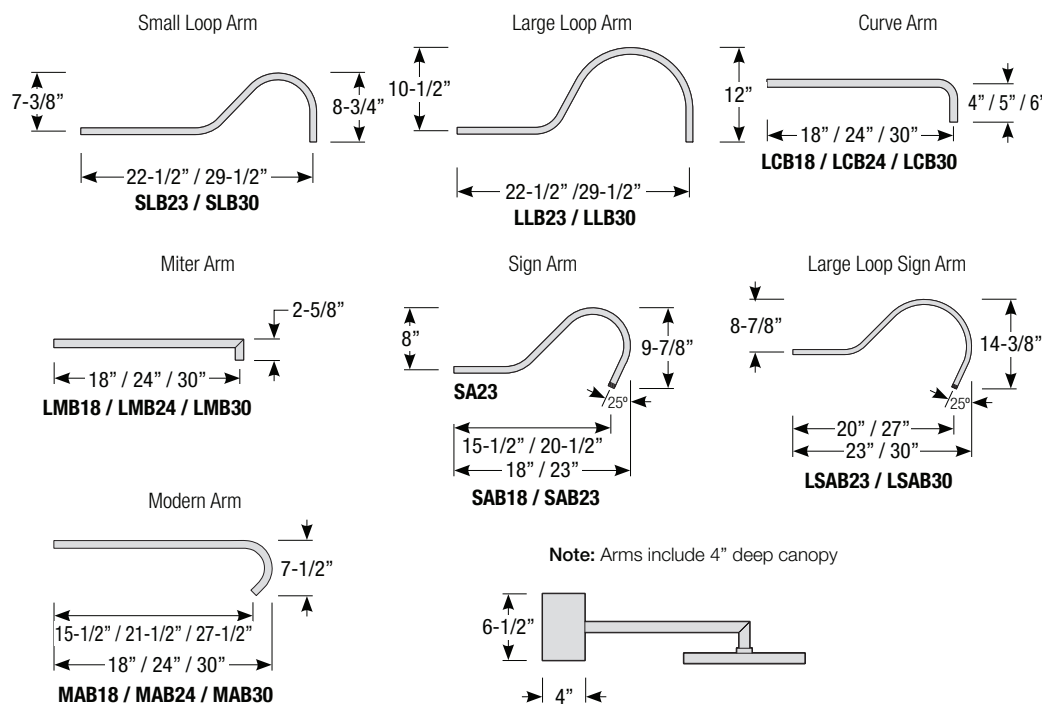

Note: Arms include 4" deep canopy

Finishes	
	ABL (Aegean Blue)
	BB (Burnished Bronze)
	BK (Gloss Black)
	BLU (Blue)
	DVG (Dove Gray)
	FLG (Flannel Gray)
	GA³ (Galvanized)
	LG (Lime Green)
	MB (Matte Black)
	MBL (Midnight Blue)
	PNA (Painted Natural Aluminum)
	PNC (Painted Natural Copper)
	RD (Red)
	SA^{2,3} (Satin Aluminum)
	SGR (Sage Green)
	SGW (Semi Gloss White)
	SND (Sand)
	SS (Satin Silver)
	TBZ (Textured Bronze)
	TGP (Textured Graphite)
	TNG (Tangerine)
	TTL (Tahitian Teal)
	WT (Gloss White)

2. Satin aluminum cannot be coastal coated
3. Specialty Finish

Stem Mount Order Matrix (Example: 2HSB18SGW)

Pipe Size	Stem Length	Finish	Coastal Coating
2 (1/2" IP)	HSB12 (12")	(Specify finish - see available finishes on right)	(blank) (No coating) -C ² (Coating)
	HSB18 (18")		
	HSB24 (24")		
	HSB36 (36")		
	HSB48 (48")		
	HSB (Custom length from 2" up to 60")		

2. Satin aluminum cannot be coated

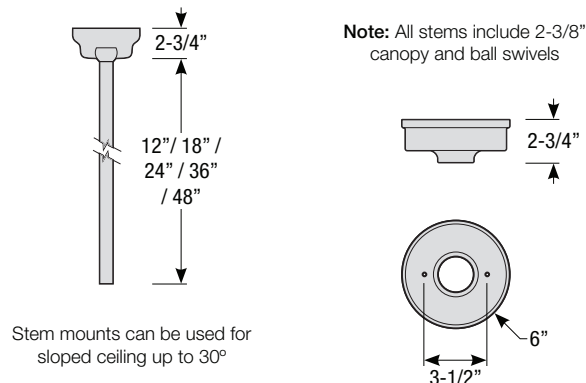

Stem mounts can be used for sloped ceiling up to 30°

GLOBE

Electrical

- 120V input (277V available in arm and post option only)
- Integrated power supply allows the fixture to be connected directly into line voltage
- Pre-wired and ready for install
- LED is dimmable with Incandescent/Triac dimmers

Mounting

- 1/2" or 3/4" IP for arms. Flush mount, stems and post available only in 1/2", see next page
- 9' Pendant cord available in black or white cord (includes 5" canopy with the same finish as the shade)

Finishes

- Top cover and mounting finish options
- Available in 21 standard and 2 specialty finishes with optional coastal coating to protect finish in coastal environments (add "-C" to the finish)
- Consult factory for custom finish options

Listing

UL listed to US and Canadian standards for wet locations



GL14LED1527TBZ-2 / 2HS36TBZ

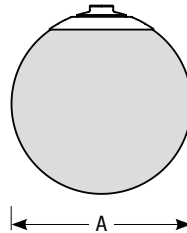

	A
GL12	12"
GL14	14"
GL16	16"
GL18	18"

Globe Order Matrix (Example: GL14LED1527TBZ-2)

Diameter	Lamp / LED	Top Cover Finish	Coastal Coating	Mounting Type
GL12 (12")	M (Medium Base, 100w max.)	ABL (Aegean Blue)	(blank) (No coating)	-2 (1/2" IP)
GL14 (14")	GU2413¹ (13W GU24 / 2700K)	BB (Burnished Bronze)	-C² (Coating)	-3 (3/4" IP)
GL16 (16")	GU2418¹ (18W GU24 / 2700K)	BK (Gloss Black)		-B (Black Cord Pendant)
GL18 (18")	GU2426¹ (26W GU24 / 2700K)	BLU (Blue)		-W (White Cord Pendant)
	GU2432¹ (32W GU24 / 2700K)	DVG (Dove Gray)		-F (Flush Mount)
	GU2442¹ (42W GU24 / 2700K)	FLG (Flannel Gray)		
	LED1127¹ (11W LED / 2700K / 90 CRI / 1188lm)	GA (Galvanized)		
	LED1130¹ (11W LED / 3000K / 90 CRI / 1265lm)	LG (Lime Green)		
	LED1135¹ (11W LED / 3500K / 90 CRI / 1305lm)	MB (Matte Black)		
	LED1140¹ (11W LED / 4000K / 90 CRI / 1364lm)	MBL (Midnight Blue)		
	LED1527¹ (15W LED / 2700K / 90 CRI / 1620lm)	PNA (Painted Natural Aluminum)		
	LED1530¹ (15W LED / 3000K / 90 CRI / 1725lm)	PNC (Painted Natural Copper)		
	LED1535¹ (15W LED / 3500K / 90 CRI / 1780lm)	RD (Red)		
	LED1540¹ (15W LED / 4000K / 90 CRI / 1860lm)	SA (Satin Aluminum)		
		SGR (Sage Green)		
		SGW (Semi Gloss White)		
		SND (Sand)		
		SS (Satin Silver)		
		TBZ (Textured Bronze)		
		TGP (Textured Graphite)		
		TNG (Tangerine)		
		TTL (Tahitian Teal)		
		WT (Gloss White)		

1. Lamp/LED included

2. Satin aluminum cannot be coated

Compatible Mounts - see pages 56-58 for detailed specs

Arm Mount Order Matrix (Example: 2SL23TBZ)

Pipe Size	Arm Type	Finish	Coastal Coating	Input Voltage
2 (1/2" IP)	SL23 (Small Loop - 23")	(Specify finish - see available finishes on right)	(blank) (No coating)	(blank) (120V)
3 (3/4" IP)	SL30 (Small Loop - 30")		-C ² (Coating)	-27 (277V)
	LL23 (Large Loop - 23")			
	LL30 (Large Loop - 30")			
	LC18 (Curve Arm - 18")			
	LC24 (Curve Arm - 24")			
	LC30 (Curve Arm - 30")			
	LM18 (Miter Arm - 18")			
	LM24 (Miter Arm - 24")			
	LM30 (Miter Arm - 30")			
	SA18 (Sign Arm - 18")			
	SA23 (Sign Arm - 23")			
	LSA23 (Large Loop Sign Arm - 23")			
	LSA30 (Large Loop Sign Arm - 30")			
	A6 (Straight Arm - 6")			
	A12 (Straight Arm - 12")			
	A18 (Straight Arm - 18")			
	A24 (Straight Arm - 24")			
	A30 (Straight Arm - 30")			
	MA18 (Modern Arm - 18")			
	MA24 (Modern Arm - 24")			
	MA30 (Modern Arm - 30")			

2. Satin aluminum cannot be coated

Knuckle Accessory Order Matrix (Example: 2KNLTBZ)

Pipe Size	Knuckle	Finish	Coastal Coating
2 (1/2" IP)	KNL (Adjustable 180° Knuckle for Arm Mounts)	(Specify finish - see available finishes on right)	(blank) (No coating)
3 (3/4" IP)			-C ² (Coating)

2. Satin aluminum cannot be coated

Post / Wall Mount Order Matrix (Example: 2P1TBZ)

Pipe Size	Mount Type	Finish	Input Voltage
2 (1/2" IP)	P1 (Single Post Mount)	(Specify finish - see available finishes on right)	(blank) (120V)
	P2 (Double Post Mount)		-27 ³ (277V)
	W1 (Traditional Wall Mount)		

3. Post mount only























Post Type Order Matrix (Example: P8683-96TBZ)

Post Type	Finish
PM4946 (Cast Aluminum Post)	(Specify finish - see available finishes on right)
P8683-96 (Cast Aluminum Base w/ 96" Aluminum Post)	
P8683-120 (Cast Aluminum Base w/ 120" Aluminum Post)	
P8684-96 (96" Straight Aluminum Post)	
P8684-120 (120" Straight Aluminum Post)	
PM8685 (Cast Aluminum Pier Mount - must be used with straight aluminum post, P8683)	

Stem Mount Order Matrix (Example: 2HS36TBZ)

Pipe Size	Stem Length	Finish	Coastal Coating
2 (1/2" IP)	HS12 (12")	(Specify finish - see available finishes on right)	(blank) (No coating)
	HS18 (18")		-C ² (Coating)
	HS24 (24")		
	HS36 (36")		
	HS48 (48")		
	HS__ (Custom length from 2" up to 60")		

2. Satin aluminum cannot be coated

Finishes	
	ABL (Aegean Blue)
	BB (Burnished Bronze)
	BK (Gloss Black)
	BLU (Blue)
	DVG (Dove Gray)
	FLG (Flannel Gray)
	GA^{4,5} (Galvanized)
	LG (Lime Green)
	MB (Matte Black)
	MBL (Midnight Blue)
	PNA (Painted Natural Aluminum)
	PNC (Painted Natural Copper)
	RD (Red)
	SA^{2,4,5} (Satin Aluminum)
	SGR (Sage Green)
	SGW (Semi Gloss White)
	SND (Sand)
	SS (Satin Silver)
	TBZ (Textured Bronze)
	TGP (Textured Graphite)
	TNG (Tangerine)
	TTL (Tahitian Teal)
	WT (Gloss White)

2. Satin aluminum cannot be coastal coated
 4. Post mount cannot be painted with specialty finishes
 5. Specialty finish

HEAVY DUTY

Electrical

- 120V input (277V available in arm and post option only)
- Integrated power supply allows the fixture to be connected directly into line voltage
- Pre-wired and ready for install
- LED is dimmable with Incandescent/Triac dimmers

Mounting

- 1/2" or 3/4" IP for arms. Flush mount, stems and post available only in 1/2", see next page
- 9' Pendant cord available in black or white cord (includes 5" canopy with the same finish as the shade)

Finishes

- Shade and mounting finish options
- Available in 21 standard and 2 specialty finishes with optional coastal coating to protect finish in coastal environments (add "-C" to the finish)
- Inner shade is painted gloss white
- Consult factory for custom finish options

Optional Accessories

- Glass, Cast Guard or Wire Guard options available, see page 57

Listing

UL listed to US and Canadian standards for wet locations



RH18LED1127PNA-3 / 3LL23PNA

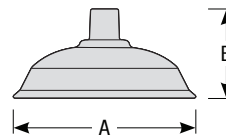

	A	B
RH12	12"	7-1/4"
RH14	14"	8-1/4"
RH16	16"	9-1/4"
RH18	18"	10-1/4"
RH20	20"	11-1/4"

Heavy Duty Order Matrix (Example: RH18LED1127PNA-3)

Diameter	Lamp / LED	Finish	Coastal Coating	Accessories	Mounting Type
RH12 (12")	M (Medium Base, 100W max.)	ABL (Aegean Blue)	(blank) (No coating)	(blank) (No accessories)	-2 (1/2" IP)
RH14 (14")	GU2413 ¹ (13W GU24 / 2700K)	BB (Burnished Bronze)	-C ⁴ (Coating)	-CG (Clear Glass)	-3 (3/4" IP)
RH16 (16")	GU2418 ¹ (18W GU24 / 2700K)	BK (Gloss Black)		-FG (Frosted Glass)	-B (Black Cord Pendant)
RH18 (18")	GU2426 ¹ (26W GU24 / 2700K)	BLU (Blue)		-OG (Opal Glass)	-W (White Cord Pendant)
RH20 (20")	GU2432 ^{1,2} (32W GU24 / 2700K)	DVG (Dove Gray)		-CGG (Clear Glass w/ Cast Guard)	-F (Flush Mount)
	GU2442 ^{1,2} (42W GU24 / 2700K)	FLG (Flannel Gray)		-FGG (Frosted Glass w/ Cast Guard)	
	LED1127 ^{1,3} (11W LED / 2700K / 90 CRI / 1188lm)	GA (Galvanized)		-OGG (Opal Glass w/ Cast Guard)	
	LED1130 ^{1,3} (11W LED / 3000K / 90 CRI / 1265lm)	LG (Lime Green)		-CGWC (Clear Glass w/ Wire Cage)	
	LED1135 ^{1,3} (11W LED / 3500K / 90 CRI / 1305lm)	MB (Matte Black)		-FGWC (Frosted Glass w/ Wire Cage)	
	LED1140 ^{1,3} (11W LED / 4000K / 90 CRI / 1364lm)	MBL (Midnight Blue)		-OGWC (Opal Glass w/ Wire Cage)	
	LED1527 ^{1,3} (15W LED / 2700K / 90 CRI / 1620lm)	PNA (Painted Natural Aluminum)		-WG (Wire Guard)	
	LED1530 ^{1,3} (15W LED / 3000K / 90 CRI / 1725lm)	PNC (Painted Natural Copper)			
	LED1535 ^{1,3} (15W LED / 3500K / 90 CRI / 1780lm)	RD (Red)			
	LED1540 ^{1,3} (15W LED / 4000K / 90 CRI / 1860lm)	SA (Satin Aluminum)			
		SGR (Sage Green)			
		SGW (Semi Gloss White)			
		SND (Sand)			
		SS (Satin Silver)			
		TBZ (Textured Bronze)			
	TGP (Textured Graphite)				
	TNG (Tangerine)				
	TTL (Tahitian Teal)				
	WT (Gloss White)				

1. Lamp/LED included
2. Not for use in glass/cast guard/wire cage
3. Glass enclosure must be specified

4. Satin aluminum cannot be coated



Compatible Mounts - see pages 56-58 for detailed specs

Arm Mount Order Matrix (Example: 3LL23PNA)

Pipe Size	Arm Type	Finish	Coastal Coating	Input Voltage
2 (1/2" IP)	SL23 (Small Loop- 23")	(Specify finish - see available finishes on right)	(blank) (No coating)	(blank) (120V)
3 (3/4" IP)	SL30 (Small Loop- 30")		-C ⁴ (Coating)	-27 (277V)
	LL23 (Large Loop - 23")			
	LL30 (Large Loop - 30")			
	LC18 (Curve Arm - 18")			
	LC24 (Curve Arm - 24")			
	LC30 (Curve Arm - 30")			
	LM18 (Miter Arm - 18")			
	LM24 (Miter Arm - 24")			
	LM30 (Miter Arm - 30")			
	SA18 (Sign Arm - 18")			
	SA23 (Sign Arm - 23")			
	LSA23 (Large Loop Sign Arm - 23")			
	LSA30 (Large Loop Sign Arm - 30")			
	A6 (Straight Arm - 6")			
	A12 (Straight Arm - 12")			
	A18 (Straight Arm - 18")			
	A24 (Straight Arm - 24")			
	A30 (Straight Arm - 30")			
	MA18 (Modern Arm - 18")			
	MA24 (Modern Arm - 24")			
	MA30 (Modern Arm - 30")			

4. Satin aluminum cannot be coated

Knuckle Accessory Order Matrix (Example: 2KNLPNA)

Pipe Size	Knuckle	Finish	Coastal Coating
2 (1/2" IP)	KNL (Adjustable 180° Knuckle for Arm Mounts)	(Specify finish - see available finishes on right)	(blank) (No coating)
3 (3/4" IP)			-C ⁴ (Coating)

4. Satin aluminum cannot be coated

Post / Wall Mount Order Matrix (Example: 2W1PNA)

Pipe Size	Mount Type	Finish	Input Voltage
2 (1/2" IP)	P1 (Single Post Mount)	(Specify finish - see available finishes on right)	(blank) (120V)
	P2 (Double Post Mount)		-27 ⁵ (277V)
	W1 (Traditional Wall Mount)		

5. Post mount only

Post Type Order Matrix (Example: P8683-96PNA)

Post Type	Finish
PM4946 (Cast Aluminum Post)	(Specify finish - see available finishes on right)
P8683-96 (Cast Aluminum Base w/ 96" Aluminum Post)	
P8683-120 (Cast Aluminum Base w/ 120" Aluminum Post)	
P8684-96 (96" Straight Aluminum Post)	
P8684-120 (120" Straight Aluminum Post)	
PM8685 (Cast Aluminum Pier Mount - must be used with straight aluminum post, P8683)	

Stem Mount Order Matrix (Example: 2HS18PNA)

Pipe Size	Stem Length	Finish	Coastal Coating
2 (1/2" IP)	HS12 (12")	(Specify finish - see available finishes on right)	(blank) (No coating)
	HS18 (18")		-C ⁴ (Coating)
	HS24 (24")		
	HS36 (36")		
	HS48 (48")		
	HS__ (Custom length from 2" up to 60")		

4. Satin aluminum cannot be coated

Finishes	
	ABL (Aegean Blue)
	BB (Burnished Bronze)
	BK (Gloss Black)
	BLU (Blue)
	DVG (Dove Gray)
	FLG (Flannel Gray)
	GA^{6,7} (Galvanized)
	LG (Lime Green)
	MB (Matte Black)
	MBL (Midnight Blue)
	PNA (Painted Natural Aluminum)
	PNC (Painted Natural Copper)
	RD (Red)
	SA^{4,6,7} (Satin Aluminum)
	SGR (Sage Green)
	SGW (Semi Gloss White)
	SND (Sand)
	SS (Satin Silver)
	TBZ (Textured Bronze)
	TGP (Textured Graphite)
	TNG (Tangerine)
	TTL (Tahitian Teal)
	WT (Gloss White)

4. Satin aluminum cannot be coastal coated
6. Post mount cannot be painted with specialty finishes
7. Specialty Finish

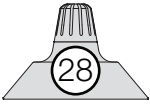

HEAVY METAL

Electrical

- 120V input (277V available in arm and post option only)
- Integrated power supply allows the fixture to be connected directly into line voltage
- Pre-wired and ready for install
- LED is dimmable with Incandescent/Triac dimmers

Mounting

- 1/2" or 3/4" IP for arms. Flush mount, stems and post available only in 1/2", see next page
- 9' Pendant cord available in black or white cord (includes 5" canopy with the same finish as the shade)

Finishes

- Two toned shade and top option
- Available in 21 standard and 2 specialty finishes with optional coastal coating to protect finish in coastal environments (add "-C" to the finish)
- Inner shade is painted gloss white
- Consult factory for custom finish options

Optional Accessories

- Glass or Cast Guard options available, see page 57

Listing

UL listed to US and Canadian standards for wet locations



HM18LED3627RDSS-FGG-3 / 3LL23SS

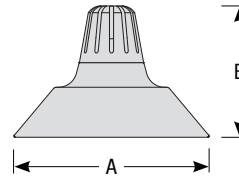

	A	B
HM18	18"	12"
HM20	20"	13"

Heavy Metal Order Matrix (Example: HM18LED3627RDSS-FGG-3)

Diameter	Lamp / LED	Shade Finish	Top Finish	Coastal Coating	Accessories	Mounting Type
HM18 (18")	M (Medium Base, 100W max.)	ABL (Aegean Blue)	ABL	(blank) (No coating)	(blank) (No accessories)	-2 (1/2" IP)
HM20 (20")	GU2413¹ (13W GU24 / 2700K)	BB (Burnished Bronze)	BB	-C⁴ (Coating)	-3 (Clear Glass)	-3 (3/4" IP)
	GU2418¹ (18W GU24 / 2700K)	BK (Gloss Black)	BK		-FG (Frosted Glass)	-B (Black Cord Pendant)
	GU2426¹ (26W GU24 / 2700K)	BLU (Blue)	BLU		-OG (Opal Glass)	-W (White Cord Pendant)
	GU2432^{1,2} (32W GU24 / 2700K)	DVG (Dove Gray)	DVG		-CGG (Clear Glass w/ Cast Guard)	-F (Flush Mount)
	GU2442^{1,2} (42W GU24 / 2700K)	FLG (Flannel Gray)	FLG		-FGG (Frosted Glass w/ Cast Guard)	
	LED1127^{1,3} (11W LED / 2700K / 90 CRI / 1188lm)	GA (Galvanized)	GA		-OGG (Opal Glass w/ Cast Guard)	
	LED1130^{1,3} (11W LED / 3000K / 90 CRI / 1265lm)	LG (Lime Green)	LG			
	LED1135^{1,3} (11W LED / 3500K / 90 CRI / 1305lm)	MB (Matte Black)	MB			
	LED1140^{1,3} (11W LED / 4000K / 90 CRI / 1364lm)	MBL (Midnight Blue)	MBL			
	LED1527^{1,3} (15W LED / 2700K / 90 CRI / 1620lm)	PNA (Painted Natural Aluminum)	PNA			
	LED1530^{1,3} (15W LED / 3000K / 90 CRI / 1725lm)	PNC (Painted Natural Copper)	PNC			
	LED1535^{1,3} (15W LED / 3500K / 90 CRI / 1780lm)	RD (Red)	RD			
	LED1540^{1,3} (15W LED / 4000K / 90 CRI / 1860lm)	SA (Satin Aluminum)	SA			
	LED2427^{1,3} (24W LED / 2700K / 90 CRI / 1840lm)	SGR (Sage Green)	SGR			
	LED2430^{1,3} (24W LED / 3000K / 90 CRI / 1920lm)	SGW (Semi Gloss White)	SGW			
	LED2435^{1,3} (24W LED / 3500K / 90 CRI / 2000lm)	SND (Sand)	SND			
	LED2440^{1,3} (24W LED / 4000K / 90 CRI / 2080lm)	SS (Satin Silver)	SS			
	LED3627^{1,3} (36W LED / 2700K / 90 CRI / 2470lm)	TBZ (Textured Bronze)	TBZ			
	LED3630^{1,3} (36W LED / 3000K / 90 CRI / 2595lm)	TGP (Textured Graphite)	TGP			
	LED3635^{1,3} (36W LED / 3500K / 90 CRI / 2720lm)	TNG (Tangerine)	TNG			
	LED3640^{1,3} (36W LED / 4000K / 90 CRI / 2845lm)	TTL (Tahitian Teal)	TTL			
		WT (Gloss White)	WT			

1. Lamp/LED included
 2. Not for use in glass/cast guard/wire cage
 3. Glass enclosure must be specified

4. Satin aluminum cannot be coated



Compatible Mounts - see pages 56-58 for detailed specs

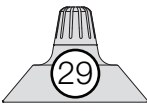

Arm Mount Order Matrix (Example: 3LL23SS)

Pipe Size	Arm Type	Finish	Coastal Coating	Input Voltage
2 (1/2" IP)	SL23 (Small Loop- 23")	(Specify finish - see available finishes on right)	(blank) (No coating)	(blank) (120V)
3 (3/4" IP)	SL30 (Small Loop- 30")		-C ⁴ (Coating)	-27 (277V)
	LL23 (Large Loop - 23")			
	LL30 (Large Loop - 30")			
	LC18 (Curve Arm - 18")			
	LC24 (Curve Arm - 24")			
	LC30 (Curve Arm - 30")			
	LM18 (Miter Arm - 18")			
	LM24 (Miter Arm - 24")			
	LM30 (Miter Arm - 30")			
	SA18 (Sign Arm - 18")			
	SA23 (Sign Arm - 23")			
	LSA23 (Large Loop Sign Arm - 23")			
	LSA30 (Large Loop Sign Arm - 30")			
	A6 (Straight Arm - 6")			
	A12 (Straight Arm - 12")			
	A18 (Straight Arm - 18")			
	A24 (Straight Arm - 24")			
	A30 (Straight Arm - 30")			
	MA18 (Modern Arm - 18")			
	MA24 (Modern Arm - 24")			
	MA30 (Modern Arm - 30")			

4. Satin aluminum cannot be coated

Knuckle Accessory Order Matrix (Example: 3KNLSS)

Pipe Size	Knuckle	Finish	Coastal Coating
2 (1/2" IP)	KNL (Adjustable 180° Knuckle for Arm Mounts)	(Specify finish - see available finishes on right)	(blank) (No coating)
3 (3/4" IP)			-C ⁴ (Coating)

4. Satin aluminum cannot be coated

Post / Wall Mount Order Matrix (Example: 2W1SS)

Pipe Size	Mount Type	Finish	Input Voltage
2 (1/2" IP)	P1 (Single Post Mount)	(Specify finish - see available finishes on right)	(blank) (120V)
	P2 (Double Post Mount)		-27 ⁵ (277V)
	W1 (Traditional Wall Mount)		

5. Post mount only

Post Type Order Matrix (Example: P8683-96SS)

Post Type	Finish
PM4946 (Cast Aluminum Post)	(Specify finish - see available finishes on right)
P8683-96 (Cast Aluminum Base w/ 96" Aluminum Post)	
P8683-120 (Cast Aluminum Base w/ 120" Aluminum Post)	
P8684-96 (96" Straight Aluminum Post)	
P8684-120 (120" Straight Aluminum Post)	
PM8685 (Cast Aluminum Pier Mount - must be used with straight aluminum post, P8683)	

Stem Mount Order Matrix (Example: 2HS18SS)

Pipe Size	Stem Length	Finish	Coastal Coating
2 (1/2" IP)	HS12 (12")	(Specify finish - see available finishes on right)	(blank) (No coating)
	HS18 (18")		-C ⁴ (Coating)
	HS24 (24")		
	HS36 (36")		
	HS48 (48")		
	HS__ (Custom length from 2" up to 60")		

4. Satin aluminum cannot be coated

Finishes	
	ABL (Aegean Blue)
	BB (Burnished Bronze)
	BK (Gloss Black)
	BLU (Blue)
	DVG (Dove Gray)
	FLG (Flannel Gray)
	GA ^{6,7} (Galvanized)
	LG (Lime Green)
	MB (Matte Black)
	MBL (Midnight Blue)
	PNA (Painted Natural Aluminum)
	PNC (Painted Natural Copper)
	RD (Red)
	SA ^{4,6,7} (Satin Aluminum)
	SGR (Sage Green)
	SGW (Semi Gloss White)
	SND (Sand)
	SS (Satin Silver)
	TBZ (Textured Bronze)
	TGP (Textured Graphite)
	TNG (Tangerine)
	TTL (Tahitian Teal)
	WT (Gloss White)

4. Satin aluminum cannot be coastal coated
 6. Post mount cannot be painted with specialty finishes
 7. Specialty Finish



LS SERIES - BULLET HEAD

Electrical

- 120/277V input
- Integrated power supply allows the fixture to be connected directly into line voltage
- Pre-wired and ready for install
- Dimmable with 120V Incandescent/Triac/0-10V dimmers

Mounting

- 3/4" IP for arm, stem or monopoint options, see next page

Finishes

- Available in 21 standard and 2 specialty finishes with optional coastal coating to protect finish in coastal environments (add "-C" to the finish)
- Consult factory for custom finish options

Adjustability

- 360° horizontal and 180° vertical rotation

Optics

- 25°, 45° and 65° optics included (85° optic available, must specify)

Listing

UL listed to US and Canadian standards for wet locations



LBLED14TBZ-3 / 3LBS24TBZ



LBLED14WT-3 / 3LBMNPWT



LBLED14BK-3 / 3LBU24BK



(2) LBLED14MB-3 / 3LBD30MB



LBLED14TBZ-3 / 3LBM24TBZ

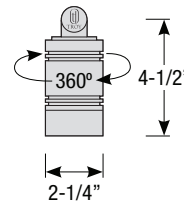

LS Series - Bullet Head Order Matrix (Example: LBLED14TBZ-3)

Series	LED Light Engine	Finish	Coastal Coating	Mounting Type
LB	LED14 ¹ (14W LED / 2700K / 90 CRI / 980lm)	ABL (Aegean Blue) BB (Burnished Bronze) BK (Gloss Black) BLU (Blue) DVG (Dove Gray) FLG (Flannel Gray) GA (Galvanized) LG (Lime Green) MB (Matte Black) MBL (Midnight Blue) PNA (Painted Natural Aluminum) PNC (Painted Natural Copper) RD (Red) SA (Satin Aluminum) SGR (Sage Green) SGW (Semi Gloss White) SND (Sand) SS (Satin Silver) TBZ (Textured Bronze) TGP (Textured Graphite) TNG (Tangerine) TTL (Tahitian Teal) WT (Gloss White)	(blank) (No coating) -C² (Coating)	-3 (3/4" IP)

1. Lamp/LED included

2. Satin aluminum cannot be coated



Compatible Mounts

Arm Mount Order Matrix (Example: 3LBM24TBZ)

Pipe Size	Arm Type	Finish	Coastal Coating
3 (3/4" IP)	LBM18 (Miter Arm - 18")	(Specify finish - see available finishes on right)	(blank) (No coating)
	LBM24 (Miter Arm - 24")		-C ² (Coating)
	LBM30 (Miter Arm - 30")		
	LBU18 ("U" Arm - 18")		
	LBU24 ("U" Arm - 24")		
	LBU30 ("U" Arm - 30")		
	LBD18³ (Dual Arm - 18")		
	LBD24³ (Dual Arm - 24")		
	LBD30³ (Dual Arm - 30")		

3. Dual arm requires (2) fixture heads

2. Satin aluminum cannot be coated

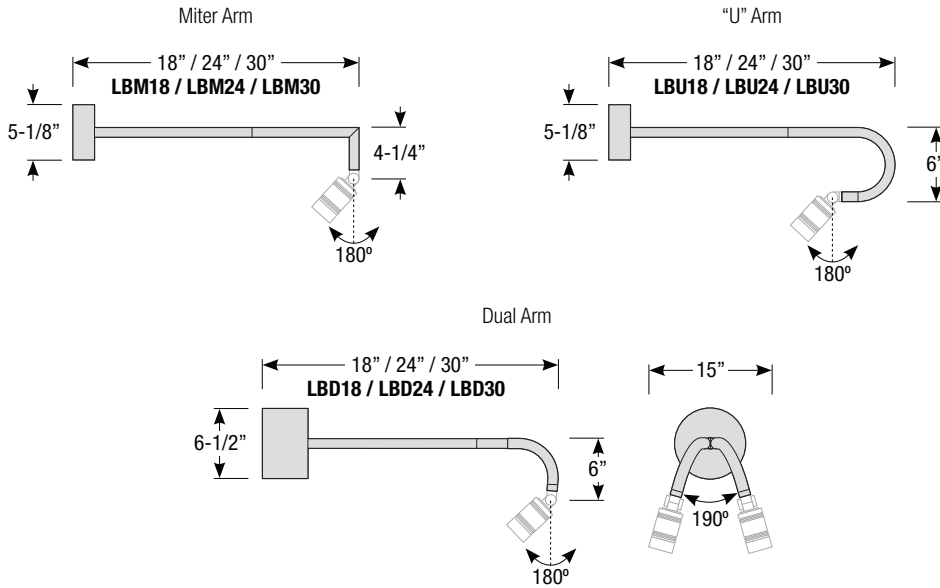

Stem Mount Order Matrix (Example: 3LBS24TBZ)

Pipe Size	Stem Length	Finish	Coastal Coating
3 (3/4" IP)	LBS6 (6")	(Specify finish - see available finishes on right)	(blank) (No coating)
	LBS12 (12")		-C ² (Coating)
	LBS24 (24")		
	LBS36 (36")		

2. Satin aluminum cannot be coated

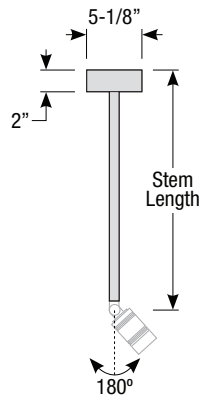

Monopoint Order Matrix (Example: 3LBMNPWT)

Pipe Size	Monopoint	Finish	Coastal Coating
3 (3/4" IP)	LBMNP	(Specify finish - see available finishes on right)	(blank) (No coating) -C ² (Coating)

2. Satin aluminum cannot be coated

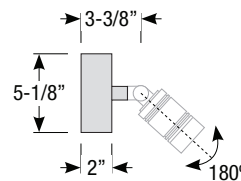

Finishes

- ABL** (Aegean Blue)
- BB** (Burnished Bronze)
- BK** (Gloss Black)
- BLU** (Blue)
- DVG** (Dove Gray)
- FLG** (Flannel Gray)
- GA⁴** (Galvanized)
- LG** (Lime Green)
- MB** (Matte Black)
- MBL** (Midnight Blue)
- PNA** (Painted Natural Aluminum)
- PNC** (Painted Natural Copper)
- RD** (Red)
- SA^{2,4}** (Satin Aluminum)
- SGR** (Sage Green)
- SGW** (Semi Gloss White)
- SND** (Sand)
- SS** (Satin Silver)
- TBZ** (Textured Bronze)
- TGP** (Textured Graphite)
- TNG** (Tangerine)
- TTL** (Tahitian Teal)
- WT** (Gloss White)

2. Satin aluminum cannot be coastal coated
 4. Specialty Finish

MID CENTURY

Electrical

- 120V input (277V available, must specify on arm mount)
- Integrated power supply allows the fixture to be connected directly into line voltage
- Pre-wired and ready for install
- LED is dimmable with Incandescent/Triac dimmers

Mounting

- 1/2" IP or 3/4" IP straight arms available, see next page

Finishes

- Two-toned shade and center adapter finish options
- Available in 21 standard and 2 specialty finishes with optional coastal coating to protect finish in coastal environments (add "-C" to the finish)
- Consult factory for custom finish options

Listing

UL listed to US and Canadian standards for wet locations



MC10LED1127MBMB-3
3MCA24MB

MC12LED1127DVGFLG-3 /
3MCA24FLG

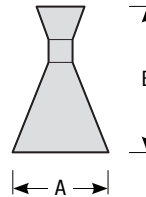

	A	B
MC8	8"	12-1/8"
MC10	10"	15-1/4"
MC12	12"	18"

Mid Century Order Matrix (Example: MC12LED1127DVGFLG-3)

Diameter	Lamp / LED	Shade Finish	Center Adapter Finish	Coastal Coating	Pipe
MC8 (8")	M (Medium Base, 100W max.)	ABL (Aegean Blue)	ABL (Aegean Blue)	(blank) (No coating)	-2 (1/2" IP)
MC10 (10")	GU2413¹ (13W GU24 / 2700K)	BB (Burnished Bronze)	BB (Burnished Bronze)	-C² (Coating)	-3 (3/4" IP)
MC12 (12")	GU2418¹ (18W GU24 / 2700K)	BK (Gloss Black)	BK (Gloss Black)		-B (Black Cord Pendant)
	GU2426¹ (26W GU24 / 2700K)	BLU (Blue)	BLU (Blue)		-W (White Cord Pendant)
	GU2432¹ (32W GU24 / 2700K)	DVG (Dove Gray)	DVG (Dove Gray)		
	GU2442¹ (42W GU24 / 2700K)	FLG (Flannel Gray)	FLG (Flannel Gray)		
	LED1127¹ (11W LED / 2700K / 90 CRI / 1188lm)	GA (Galvanized)	GA (Galvanized)		
	LED1130¹ (11W LED / 3000K / 90 CRI / 1265lm)	LG (Lime Green)	LG (Lime Green)		
	LED1135¹ (11W LED / 3500K / 90 CRI / 1305lm)	MB (Matte Black)	MB (Matte Black)		
	LED1140¹ (11W LED / 4000K / 90 CRI / 1364lm)	MBL (Midnight Blue)	MBL (Midnight Blue)		
	LED1527¹ (15W LED / 2700K / 90 CRI / 1620lm)	PNA (Painted Natural Aluminum)	PNA (Painted Natural Aluminum)		
	LED1530¹ (15W LED / 3000K / 90 CRI / 1725lm)	PNC (Painted Natural Copper)	PNC (Painted Natural Copper)		
	LED1535¹ (15W LED / 3500K / 90 CRI / 1780lm)	RD (Red)	RD (Red)		
	LED1540¹ (15W LED / 4000K / 90 CRI / 1860lm)	SA (Satin Aluminum)	SA (Satin Aluminum)		
		SGR (Sage Green)	SGR (Sage Green)		
		SGW (Semi Gloss White)	SGW (Semi Gloss White)		
		SND (Sand)	SND (Sand)		
		SS (Satin Silver)	SS (Satin Silver)		
		TBZ (Textured Bronze)	TBZ (Textured Bronze)		
		TGP (Textured Graphite)	TGP (Textured Graphite)		
		TNG (Tangerine)	TNG (Tangerine)		
		TTL (Tahitian Teal)	TTL (Tahitian Teal)		
		WT (Gloss White)	WT (Gloss White)		

1. Lamp/LED included

2. Satin aluminum cannot be coated

Compatible Mounts

Arm Mount Order Matrix (Example: 3MCA24FLG)

Pipe Size	Arm Type	Finish	Coastal Coating	Input Voltage
2 (1/2" IP)	MCA18 (Mid Century Straight Arm - 18")	(Specify finish - see available finishes on right)	(blank) (No coating)	(blank) (120V)
3 (3/4" IP)	MCA24 (Mid Century Straight Arm - 24")		-C ² (Coating)	-27 (277V)
	MCA30 (Mid Century Straight Arm - 30")			
	MCA__ (Mid Century Straight Arm - Custom length)			

2. Satin aluminum cannot be coated

Mid Century Straight Arm

MCA18



18"

MCA24



24"

MCA30



30"

Note: All arm mounts include canopy

120V Canopy

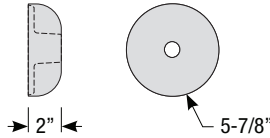

277V Canopy

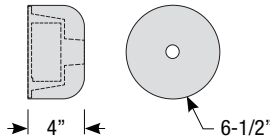

Knuckle Accessory Order Matrix (Example: 3KNLFLG)

Pipe Size	Knuckle	Finish	Coastal Coating
2 (1/2" IP)	KNL (Adjustable 180° Knuckle for Arm Mounts)	(Specify finish - see available finishes on right)	(blank) (No coating)
3 (3/4" IP)			-C ² (Coating)

2. Satin aluminum cannot be coated

Knuckle Accessory

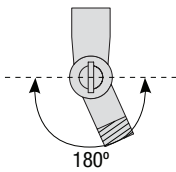

Finishes

	ABL (Aegean Blue)
	BB (Burnished Bronze)
	BK (Gloss Black)
	BLU (Blue)
	DVG (Dove Gray)
	FLG (Flannel Gray)
	GA³ (Galvanized)
	LG (Lime Green)
	MB (Matte Black)
	MBL (Midnight Blue)
	PNA (Painted Natural Aluminum)
	PNC (Painted Natural Copper)
	RD (Red)
	SA²⁻³ (Satin Aluminum)
	SGR (Sage Green)
	SGW (Semi Gloss White)
	SND (Sand)
	SS (Satin Silver)
	TBZ (Textured Bronze)
	TGP (Textured Graphite)
	TNG (Tangerine)
	TTL (Tahitian Teal)
	WT (Gloss White)

2. Satin aluminum cannot be coastal coated
3. Specialty Finish

MODERN

Electrical

- 120V input (277V available, must specify on arm mount)
- Integrated power supply allows the fixture to be connected directly into line voltage
- Pre-wired and ready for install
- Dimmable with Incandescent/Triac dimmers

Mounting

- 3/4" IP for arm mount options, see next page

Finishes

- Shade and mounting finish options
- Available in 21 standard and 2 specialty finishes with optional coastal coating to protect finish in coastal environments (add "-C" to the finish)
- Consult factory for custom finish options

Listing

UL listed to US and Canadian standards for wet locations



MD24LED25PNA-3 / 3MAA18PNA

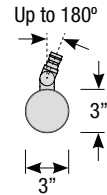
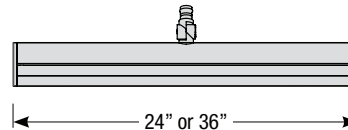

Modern Order Matrix (Example: MD24LED25PNA-3)

Length	LED Light Engine	Finish	Coastal Coating	Pipe
MD24 (24")	LED25 ¹ (25W LED / 2850K / 80 CRI / 1750lm - MD24 only)	ABL (Aegean Blue)	(blank) (No coating)	-3 (3/4" IP)
MD36 (36")	LED33 ¹ (33W LED / 2850K / 80 CRI / 2300lm - MD36 only)	BB (Burnished Bronze)	-C ² (Coating)	
		BK (Gloss Black)		
		BLU (Blue)		
		DVG (Dove Gray)		
		FLG (Flannel Gray)		
		GA (Galvanized)		
		LG (Lime Green)		
		MB (Matte Black)		
		MBL (Midnight Blue)		
		PNA (Painted Natural Aluminum)		
		PNC (Painted Natural Copper)		
		RD (Red)		
		SA (Satin Aluminum)		
		SGR (Sage Green)		
		SGW (Semi Gloss White)		
		SND (Sand)		
		SS (Satin Silver)		
		TBZ (Textured Bronze)		
		TGP (Textured Graphite)		
		TNG (Tangerine)		
		TTL (Tahitian Teal)		
		WT (Gloss White)		

1. Lamp/LED included

2. Satin aluminum cannot be coated

Compatible Mounts

Arm Mount Order Matrix (Example: 3MAA18PNA)

Pipe Size	Arm Type	Finish	Coastal Coating	Input Voltage
3 (3/4" IP)	SLA23 (Small Loop - 23")	(Specify finish - see available finishes on right)	(blank) (No coating) -C ² (Coating)	(blank) (120V) -27 (277V)
	SLA30 (Small Loop - 30")			
	LLA23 (Large Loop - 23")			
	LLA30 (Large Loop - 30")			
	LCA18 (Curve Arm - 18")			
	LCA24 (Curve Arm - 24")			
	LCA30 (Curve Arm - 30")			
	LMA18 (Miter Arm - 18")			
	LMA24 (Miter Arm - 24")			
	LMA30 (Miter Arm - 30")			
	SAA18 (Sign Arm - 18")			
	SAA23 (Sign Arm - 23")			
	LSAA23 (Large Loop Sign Arm - 23")			
	LSAA30 (Large Loop Sign Arm - 30")			
	MAA18 (Modern Arm - 18")			
MAA24 (Modern Arm - 24")				
MAA30 (Modern Arm - 30")				

2. Satin aluminum cannot be coated

Finishes		
	ABL	(Aegean Blue)
	BB	(Burnished Bronze)
	BK	(Gloss Black)
	BLU	(Blue)
	DVG	(Dove Gray)
	FLG	(Flannel Gray)
	GA³	(Galvanized)
	LG	(Lime Green)
	MB	(Matte Black)
	MBL	(Midnight Blue)
	PNA	(Painted Natural Aluminum)
	PNC	(Painted Natural Copper)
	RD	(Red)
	SA^{2,3}	(Satin Aluminum)
	SGR	(Sage Green)
	SGW	(Semi Gloss White)
	SND	(Sand)
	SS	(Satin Silver)
	TBZ	(Textured Bronze)
	TGP	(Textured Graphite)
	TNG	(Tangerine)
	TTL	(Tahitian Teal)
	WT	(Gloss White)

2. Satin aluminum cannot be coastal coated
3. Specialty Finish

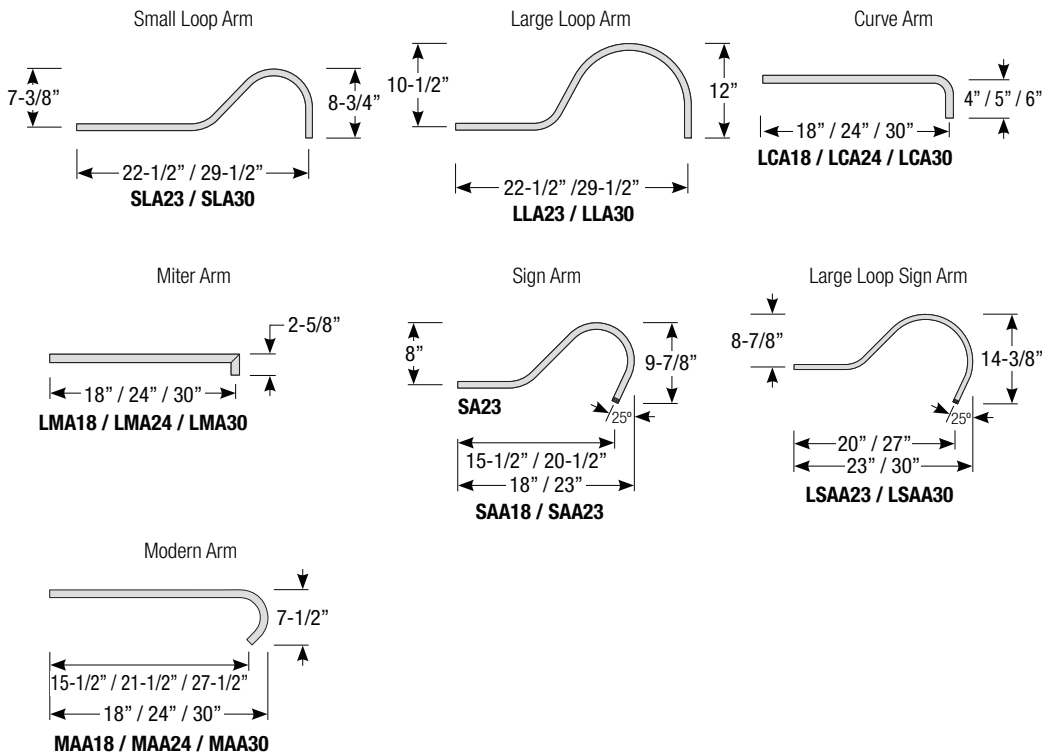

Note: All arm mounts include canopy

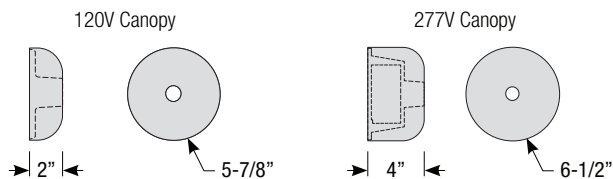



NEO

Electrical

- 120V input (277V available in arm and post option only)
- Integrated power supply allows the fixture to be connected directly into line voltage
- Pre-wired and ready for install
- LED is dimmable with Incandescent/Triac dimmers

Mounting

- 1/2" or 3/4" IP for arms. Flush mount, stems and post available only in 1/2", see next page
- 9' Pendant cord available in black or white cord (includes 5" canopy with the same finish as the shade)

Finishes

- Shade and mounting finish options
- Available in 21 standard and 2 specialty finishes with optional coastal coating to protect finish in coastal environments (add "-C" to the finish)
- Inner shade is painted gloss white
- Consult factory for custom finish options

Optional Accessories

- Glass, Cast Guard or Wire Cage options available, see page 57

Listing

UL listed to US and Canadian standards for wet locations

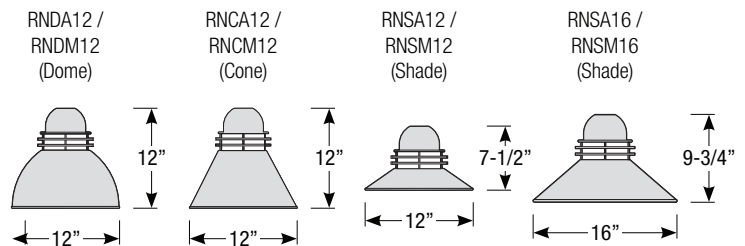

Neo Order Matrix (Example: RNDM12GU2426SA-FG-2)

Shade Style	Lamp / LED	Finish	Coastal Coating	Accessories	Mounting Type
RNDA12 (12" Dome w/Acrylic Rings)	M (Medium Base, 100W max.)	ABL (Aegean Blue)	(blank) (No coating)	(blank) (No accessories)	-2 (1/2" IP)
RNDM12 (12" Dome w/Metal Rings)	GU2413¹ (13W GU24 / 2700K)	BB (Burnished Bronze)	-C⁴ (Coating)	-CG (Clear Glass)	-3 (3/4" IP)
RNCA12 (12" Cone w/Acrylic Rings)	GU2418¹ (18W GU24 / 2700K)	BK (Gloss Black)		-FG (Frosted Glass)	-B (Black Cord Pendant)
RNCA12 (12" Cone w/Metal Rings)	GU2426¹ (26W GU24 / 2700K)	BLU (Blue)		-OG (Opal Glass)	-W (White Cord Pendant)
RNCM12 (12" Cone w/Acrylic Rings)	GU2432^{1,2} (32W GU24 / 2700K)	DVG (Dove Gray)		-CGG (Clear Glass w/ Cast Guard)	-F (Flush Mount)
RNCM12 (12" Cone w/Metal Rings)	GU2442^{1,2} (42W GU24 / 2700K)	FLG (Flannel Gray)		-FGG (Frosted Glass w/ Cast Guard)	
RNSA12 (12" Shade w/Acrylic Rings)	LED1127^{1,3} (11W LED / 2700K / 90 CRI / 1188lm)	GA (Galvanized)		-OGG (Opal Glass w/ Cast Guard)	
RNSA12 (12" Shade w/Metal Rings)	LED1130^{1,3} (11W LED / 3000K / 90 CRI / 1265lm)	LG (Lime Green)		-CGWC (Clear Glass w/ Wire Cage)	
RNSM12 (12" Shade w/Acrylic Rings)	LED1135^{1,3} (11W LED / 3500K / 90 CRI / 1305lm)	MB (Matte Black)		-FGWC (Frosted Glass w/ Wire Cage)	
RNSM12 (12" Shade w/Metal Rings)	LED1140^{1,3} (11W LED / 4000K / 90 CRI / 1364lm)	MBL (Midnight Blue)		-OGWC (Opal Glass w/ Wire Cage)	
RNSA16 (16" Shade w/Acrylic Rings)	LED1527^{1,3} (15W LED / 2700K / 90 CRI / 1620lm)	PNA (Painted Natural Aluminum)			
RNSA16 (16" Shade w/Metal Rings)	LED1530^{1,3} (15W LED / 3000K / 90 CRI / 1725lm)	PNC (Painted Natural Copper)			
RNSM16 (16" Shade w/Acrylic Rings)	LED1535^{1,3} (15W LED / 3500K / 90 CRI / 1780lm)	RD (Red)			
RNSM16 (16" Shade w/Metal Rings)	LED1540^{1,3} (15W LED / 4000K / 90 CRI / 1860lm)	SA (Satin Aluminum)			
		SGR (Sage Green)			
		SGW (Semi Gloss White)			
		SND (Sand)			
		SS (Satin Silver)			
		TBZ (Textured Bronze)			
		TGP (Textured Graphite)			
		TNG (Tangerine)			
		TTL (Tahitian Teal)			
		WT (Gloss White)			

1. Lamp/LED included
 2. Not for use in glass/cast guard/wire cage
 3. Glass enclosure must be specified

4. Satin aluminum cannot be coated



Compatible Mounts - see pages 56-58 for detailed specs

Arm Mount Order Matrix (Example: 3LL23SGW)

Pipe Size	Arm Type	Finish	Coastal Coating	Input Voltage	
2 (1/2" IP)	SL23 (Small Loop- 23")	(Specify finish - see available finishes on right)	(blank) (No coating)	(blank) (120V)	
3 (3/4" IP)	SL30 (Small Loop- 30")		-C ⁴ (Coating)	-27 (277V)	
	LL23 (Large Loop - 23")				
	LL30 (Large Loop - 30")				
	LC18 (Curve Arm - 18")				
	LC24 (Curve Arm - 24")				
	LC30 (Curve Arm - 30")				
	LM18 (Miter Arm - 18")				
	LM24 (Miter Arm - 24")				
	LM30 (Miter Arm - 30")				
	SA18 (Sign Arm - 18")				
	SA23 (Sign Arm - 23")				
	LSA23 (Large Loop Sign Arm - 23")				
	LSA30 (Large Loop Sign Arm - 30")				
	A6 (Straight Arm - 6")				
	A12 (Straight Arm - 12")				
	A18 (Straight Arm - 18")				
	A24 (Straight Arm - 24")				
	A30 (Straight Arm - 30")				
	MA18 (Modern Arm - 18")				
	MA24 (Modern Arm - 24")				
	MA30 (Modern Arm - 30")				

4. Satin aluminum cannot be coated

Knuckle Accessory Order Matrix (Example: 2KNLSGW)

Pipe Size	Knuckle	Finish	Coastal Coating
2 (1/2" IP)	KNL (Adjustable 180° Knuckle for Arm Mounts)	(Specify finish - see available finishes on right)	(blank) (No coating)
3 (3/4" IP)			-C ⁴ (Coating)

4. Satin aluminum cannot be coated

Post / Wall Mount Order Matrix (Example: 2P1SA)

Pipe Size	Mount Type	Finish	Input Voltage
2 (1/2" IP)	P1 (Single Post Mount)	(Specify finish - see available finishes on right)	(blank) (120V)
	P2 (Double Post Mount)		-27 ⁵ (277V)
	W1 (Traditional Wall Mount)		

5. Post mount only

Post Type Order Matrix (Example: P8683-96SA)

Post Type	Finish
PM4946 (Cast Aluminum Post)	(Specify finish - see available finishes on right)
P8683-96 (Cast Aluminum Base w/ 96" Aluminum Post)	
P8683-120 (Cast Aluminum Base w/ 120" Aluminum Post)	
P8684-96 (96" Straight Aluminum Post)	
P8684-120 (120" Straight Aluminum Post)	
PM8685 (Cast Aluminum Pier Mount - must be used with straight aluminum post, P8683)	

Stem Mount Order Matrix (Example: 2HS18SGW)

Pipe Size	Stem Length	Finish	Coastal Coating
2 (1/2" IP)	HS12 (12")	(Specify finish - see available finishes on right)	(blank) (No coating)
	HS18 (18")		-C ⁴ (Coating)
	HS24 (24")		
	HS36 (36")		
	HS48 (48")		
	HS__ (Custom length from 2" up to 60")		

4. Satin aluminum cannot be coated

Finishes	
	ABL (Aegean Blue)
	BB (Burnished Bronze)
	BK (Gloss Black)
	BLU (Blue)
	DVG (Dove Gray)
	FLG (Flannel Gray)
	GA^{6,7} (Galvanized)
	LG (Lime Green)
	MB (Matte Black)
	MBL (Midnight Blue)
	PNA (Painted Natural Aluminum)
	PNC (Painted Natural Copper)
	RD (Red)
	SA^{4,6,7} (Satin Aluminum)
	SGR (Sage Green)
	SGW (Semi Gloss White)
	SND (Sand)
	SS (Satin Silver)
	TBZ (Textured Bronze)
	TGP (Textured Graphite)
	TNG (Tangerine)
	TTL (Tahitian Teal)
	WT (Gloss White)

4. Satin aluminum cannot be coastal coated
 6. Post mount cannot be painted with specialty finishes
 7. Specialty Finish

NOSTALGIA

Electrical

- 120V input (277V available in arm and post option only)
- Integrated power supply allows the fixture to be connected directly into line voltage
- Pre-wired and ready for install
- LED is dimmable with Incandescent/Triac dimmers

Mounting

- 1/2" or 3/4" IP for arms. Flush mount, stems and post available only in 1/2", see next page
- 9' Pendant cord available in black or white cord (includes 5" canopy with the same finish as the shade)

Finishes

- Shade and mounting finish options
- Available in 21 standard and 2 specialty finishes with optional coastal coating to protect finish in coastal environments (add "-C" to the finish)
- Inner shade is painted gloss white
- Consult factory for custom finish options

Optional Accessories

- Glass, Cast Guard or Wire Cage options available, see page 57

Listing

UL listed to US and Canadian standards for wet locations



NC16MTGP-FGWC-3 / 3LL23TGP

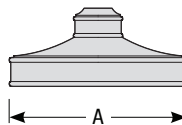

	A	B
NC14	14"	6"
NC16	16"	6"

Nostalgia Order Matrix (Example: NC16MTGP-FGWC-3)

Diameter	Lamp / LED	Finish	Coastal Coating	Accessories	Mounting Type
NC14 (14")	M (Medium Base, 100W max.)	ABL (Aegean Blue)	(blank) (No coating)	(blank) (No accessories)	-2 (1/2" IP)
NC16 (16")	GU2413 ¹ (13W GU24 / 2700K)	BB (Burnished Bronze)	-C ⁴ (Coating)	-CG (Clear Glass)	-3 (3/4" IP)
	GU2418 ¹ (18W GU24 / 2700K)	BK (Gloss Black)		-FG (Frosted Glass)	-B (Black Cord Pendant)
	GU2426 ¹ (26W GU24 / 2700K)	BLU (Blue)		-OG (Opal Glass)	-W (White Cord Pendant)
	GU2432 ^{1,2} (32W GU24 / 2700K)	DVG (Dove Gray)		-CGG (Clear Glass w/ Cast Guard)	-F (Flush Mount)
	GU2442 ^{1,2} (42W GU24 / 2700K)	FLG (Flannel Gray)		-FGG (Frosted Glass w/ Cast Guard)	
	LED1127 ^{1,3} (11W LED / 2700K / 90 CRI / 1188lm)	GA (Galvanized)		-OGG (Opal Glass w/ Cast Guard)	
	LED1130 ^{1,3} (11W LED / 3000K / 90 CRI / 1265lm)	LG (Lime Green)		-CGWC (Clear Glass w/ Wire Cage)	
	LED1135 ^{1,3} (11W LED / 3500K / 90 CRI / 1305lm)	MB (Matte Black)		-FGWC (Frosted Glass w/ Wire Cage)	
	LED1140 ^{1,3} (11W LED / 4000K / 90 CRI / 1364lm)	MBL (Midnight Blue)		-OGWC (Opal Glass w/ Wire Cage)	
	LED1527 ^{1,3} (15W LED / 2700K / 90 CRI / 1620lm)	PNA (Painted Natural Aluminum)			
	LED1530 ^{1,3} (15W LED / 3000K / 90 CRI / 1725lm)	PNC (Painted Natural Copper)			
	LED1535 ^{1,3} (15W LED / 3500K / 90 CRI / 1780lm)	RD (Red)			
	LED1540 ^{1,3} (15W LED / 4000K / 90 CRI / 1860lm)	SA (Satin Aluminum)			
		SGR (Sage Green)			
		SGW (Semi Gloss White)			
		SND (Sand)			
		SS (Satin Silver)			
		TBZ (Textured Bronze)			
		TGP (Textured Graphite)			
	TNG (Tangerine)				
	TTL (Tahitian Teal)				
	WT (Gloss White)				

1. Lamp/LED included
 2. Not for use in glass/cast guard/wire cage
 3. Glass enclosure must be specified

4. Satin aluminum cannot be coated



Compatible Mounts - see pages 56-58 for detailed specs

Arm Mount Order Matrix (Example: 3LL23TGP)

Pipe Size	Arm Type	Finish	Coastal Coating	Input Voltage
2 (1/2" IP)	SL23 (Small Loop - 23")	(Specify finish - see available finishes on right)	(blank) (No coating)	(blank) (120V)
3 (3/4" IP)	SL30 (Small Loop - 30")		-C ⁴ (Coating)	-27 (277V)
	LL23 (Large Loop - 23")			
	LL30 (Large Loop - 30")			
	LC18 (Curve Arm - 18")			
	LC24 (Curve Arm - 24")			
	LC30 (Curve Arm - 30")			
	LM18 (Miter Arm - 18")			
	LM24 (Miter Arm - 24")			
	LM30 (Miter Arm - 30")			
	SA18 (Sign Arm - 18")			
	SA23 (Sign Arm - 23")			
	LSA23 (Large Loop Sign Arm - 23")			
	LSA30 (Large Loop Sign Arm - 30")			
	A6 (Straight Arm - 6")			
	A12 (Straight Arm - 12")			
	A18 (Straight Arm - 18")			
	A24 (Straight Arm - 24")			
	A30 (Straight Arm - 30")			
	MA18 (Modern Arm - 18")			
	MA24 (Modern Arm - 24")			
	MA30 (Modern Arm - 30")			

4. Satin aluminum cannot be coated

Knuckle Accessory Order Matrix (Example: 2KNLTGP)

Pipe Size	Knuckle	Finish	Coastal Coating
2 (1/2" IP)	KNL (Adjustable 180° Knuckle for Arm Mounts)	(Specify finish - see available finishes on right)	(blank) (No coating)
3 (3/4" IP)			-C ⁴ (Coating)

4. Satin aluminum cannot be coated

Post / Wall Mount Order Matrix (Example: 2W1TGP)

Pipe Size	Mount Type	Finish	Input Voltage
2 (1/2" IP)	P1 (Single Post Mount)	(Specify finish - see available finishes on right)	(blank) (120V)
	P2 (Double Post Mount)		-27 ⁵ (277V)
	W1 (Traditional Wall Mount)		

5. Post mount only

Post Type Order Matrix (Example: P8683-96TGP)

Post Type	Finish
PM4946 (Cast Aluminum Post)	(Specify finish - see available finishes on right)
P8683-96 (Cast Aluminum Base w/ 96" Aluminum Post)	
P8683-120 (Cast Aluminum Base w/ 120" Aluminum Post)	
P8684-96 (96" Straight Aluminum Post)	
P8684-120 (120" Straight Aluminum Post)	
PM8685 (Cast Aluminum Pier Mount - must be used with straight aluminum post, P8683)	

Stem Mount Order Matrix (Example: 2HS18TGP)

Pipe Size	Stem Length	Finish	Coastal Coating
2 (1/2" IP)	HS12 (12")	(Specify finish - see available finishes on right)	(blank) (No coating)
	HS18 (18")		-C ⁴ (Coating)
	HS24 (24")		
	HS36 (36")		
	HS48 (48")		
	HS__ (Custom length from 2" up to 60")		

4. Satin aluminum cannot be coated

Finishes	
	ABL (Aegean Blue)
	BB (Burnished Bronze)
	BK (Gloss Black)
	BLU (Blue)
	DVG (Dove Gray)
	FLG (Flannel Gray)
	GA^{6,7} (Galvanized)
	LG (Lime Green)
	MB (Matte Black)
	MBL (Midnight Blue)
	PNA (Painted Natural Aluminum)
	PNC (Painted Natural Copper)
	RD (Red)
	SA^{4,6,7} (Satin Aluminum)
	SGR (Sage Green)
	SGW (Semi Gloss White)
	SND (Sand)
	SS (Satin Silver)
	TBZ (Textured Bronze)
	TGP (Textured Graphite)
	TNG (Tangerine)
	TTL (Tahitian Teal)
	WT (Gloss White)

4. Satin aluminum cannot be coastal coated
 6. Post mount cannot be painted with specialty finishes
 7. Specialty Finish

PARADIGM

Electrical

- 120/277V input
- Integrated power supply allows the fixture to be connected directly into line voltage
- Pre-wired and ready for install
- Dimmable with 120V Incandescent/Triac/0-10V dimmers

Mounting

- 1/2" IP or 3/4" IP for arms. Stems available only in 1/2", see next page

Finishes

- Two-toned shade and lens ring finish options
- Available in 21 standard and 2 specialty finishes with optional coastal coating to protect finish in coastal environments (add "-C" to the finish)
- Consult factory for custom finish options

Listing

UL listed to US and Canadian standards for wet locations



PD14LED20ABLABL-3 / 3LMB18ABL



PD18LED44PNAPNA-3 / 3LMB30PNA

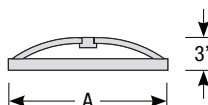

	A
PD14	14"
PD18	18"

Paradigm Order Matrix (Example: PD18LED44PNAPNA-3)

Diameter	LED Light Engine	Shade Finish	Lens Ring Finish	Coastal Coating	Pipe
PD14 (14")	LED20 ¹ (20W LED / 2800K / 80 CRI / 1200lm)	ABL (Aegean Blue)	ABL (Aegean Blue)	(blank) (No coating)	-2 (1/2" IP)
PD18 (18")	LED44 ¹ (44W LED / 2800K / 80 CRI / 2800lm - PD18 only)	BB (Burnished Bronze)	BB (Burnished Bronze)	-C ² (Coating)	-3 (3/4" IP)
		BK (Gloss Black)	BK (Gloss Black)		
		BLU (Blue)	BLU (Blue)		
		DVG (Dove Gray)	DVG (Dove Gray)		
		FLG (Flannel Gray)	FLG (Flannel Gray)		
		GA (Galvanized)	GA (Galvanized)		
		LG (Lime Green)	LG (Lime Green)		
		MB (Matte Black)	MB (Matte Black)		
		MBL (Midnight Blue)	MBL (Midnight Blue)		
		PNA (Painted Natural Aluminum)	PNA (Painted Natural Aluminum)		
		PNC (Painted Natural Copper)	PNC (Painted Natural Copper)		
		RD (Red)	RD (Red)		
		SA (Satin Aluminum)	SA (Satin Aluminum)		
		SGR (Sage Green)	SGR (Sage Green)		
		SGW (Semi Gloss White)	SGW (Semi Gloss White)		
		SND (Sand)	SND (Sand)		
		SS (Satin Silver)	SS (Satin Silver)		
		TBZ (Textured Bronze)	TBZ (Textured Bronze)		
		TGP (Textured Graphite)	TGP (Textured Graphite)		
		TNG (Tangerine)	TNG (Tangerine)		
		TTL (Tahitian Teal)	TTL (Tahitian Teal)		
		WT (Gloss White)	WT (Gloss White)		

1. Lamp/LED included

2. Satin aluminum cannot be coated



Compatible Mounts

Arm Mount Order Matrix (Example: 3LMB30PNA)

Pipe Size	Arm Type	Finish	Coastal Coating
2 (1/2" IP)	SLB23 (Small Loop - 23")	(Specify finish - see available finishes on right)	(blank) (No coating)
3 (3/4" IP)	SLB30 (Small Loop - 30")		-C ² (Coating)
	LLB23 (Large Loop - 23")		
	LLB30 (Large Loop - 30")		
	LCB18 (Curve Arm - 18")		
	LCB24 (Curve Arm - 24")		
	LCB30 (Curve Arm - 30")		
	LMB18 (Miter Arm - 18")		
	LMB24 (Miter Arm - 24")		
	LMB30 (Miter Arm - 30")		
	SAB18 (Sign Arm - 18")		
	SAB23 (Sign Arm - 23")		
	LSAB23 (Large Loop Sign Arm - 23")		
	LSAB30 (Large Loop Sign Arm - 30")		
	MAB18 (Modern Arm - 18")		
	MAB24 (Modern Arm - 24")		
	MAB30 (Modern Arm - 30")		

2. Satin aluminum cannot be coated

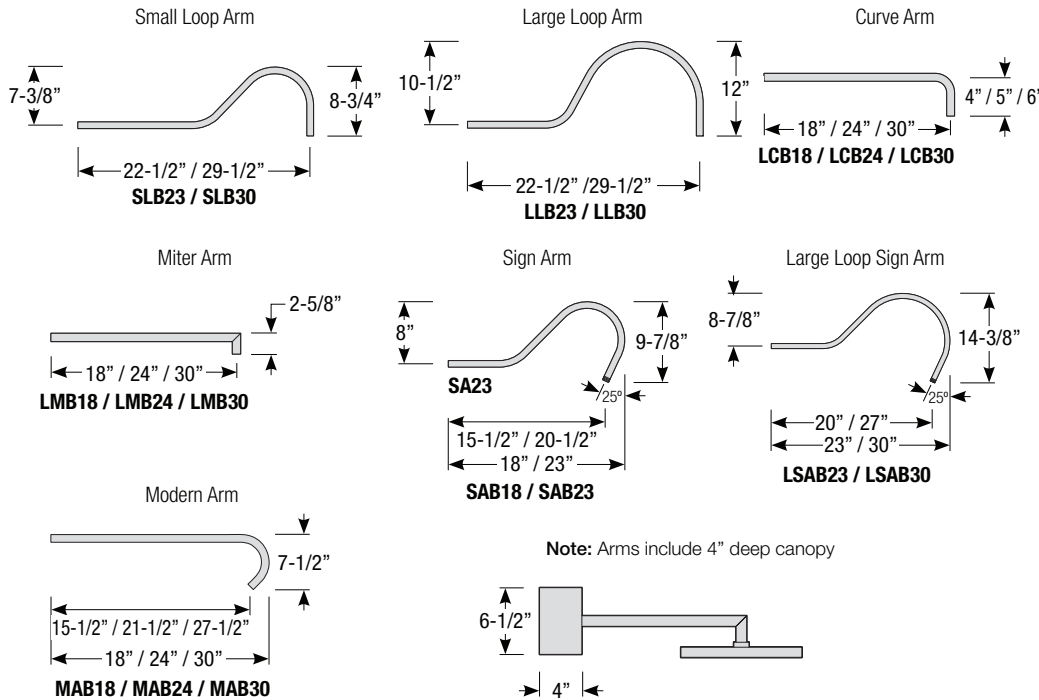

Finishes	
	ABL (Aegean Blue)
	BB (Burnished Bronze)
	BK (Gloss Black)
	BLU (Blue)
	DVG (Dove Gray)
	FLG (Flannel Gray)
	GA³ (Galvanized)
	LG (Lime Green)
	MB (Matte Black)
	MBL (Midnight Blue)
	PNA (Painted Natural Aluminum)
	PNC (Painted Natural Copper)
	RD (Red)
	SA²·³ (Satin Aluminum)
	SGR (Sage Green)
	SGW (Semi Gloss White)
	SND (Sand)
	SS (Satin Silver)
	TBZ (Textured Bronze)
	TGP (Textured Graphite)
	TNG (Tangerine)
	TTL (Tahitian Teal)
	WT (Gloss White)

2. Satin aluminum cannot be coastal coated
 3. Specialty Finish

Stem Mount Order Matrix (Example: 2HSB18PNA)

Pipe Size	Stem Length	Finish	Coastal Coating
2 (1/2" IP)	HSB12 (12")	(Specify finish - see available finishes on right)	(blank) (No coating)
	HSB18 (18")		-C ² (Coating)
	HSB24 (24")		
	HSB36 (36")		
	HSB48 (48")		
	HSB__ (Custom length from 2" up to 60")		

2. Satin aluminum cannot be coated

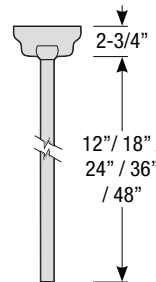

Note: All stems include 2-3/8" canopy and ball swivels

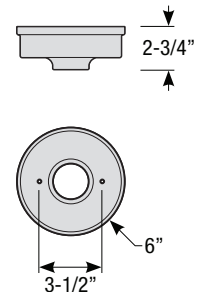

Stem mounts can be used for sloped ceiling up to 30°

RADIAL WAVE

Electrical

- 120V input (277V available in arm and post option only)
- Integrated power supply allows the fixture to be connected directly into line voltage
- Pre-wired and ready for install
- LED is dimmable with Incandescent/Triac dimmers

Mounting

- 1/2" or 3/4" IP for arms. Flush mount, stems and post available only in 1/2", see next page
- 9' Pendant cord available in black or white cord (includes 5" canopy with the same finish as the shade)

Finishes

- Shade and mounting finish options
- Available in 21 standard and 2 specialty finishes with optional coastal coating to protect finish in coastal environments (add "-C" to the finish)
- Inner shade is painted the same finish as shade
- Consult factory for custom finish options

Optional Accessories

- Glass, Cast Guard or Wire Cage options available, see page 57

Listing

UL listed to US and Canadian standards for wet locations



RW18MBK-CGG-2 /
2SL23BK

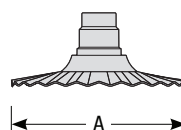

	A
RW16	16"
RW18	18"

Radial Wave Order Matrix (Example: RW18MBK-CGG-2)

Diameter	Lamp / LED	Finish	Coastal Coating	Accessories	Mounting Type
RW16 (16")	M (Medium Base, 100W max.)	ABL (Aegean Blue)	(blank) (No coating)	(blank) (No accessories)	-2 (1/2" IP)
RW18 (18")	GU2413 ¹ (13W GU24 / 2700K)	BB (Burnished Bronze)	-C ⁴ (Coating)	-CG (Clear Glass)	-3 (3/4" IP)
	GU2418 ¹ (18W GU24 / 2700K)	BK (Gloss Black)		-FG (Frosted Glass)	-B (Black Cord Pendant)
	GU2426 ¹ (26W GU24 / 2700K)	BLU (Blue)		-OG (Opal Glass)	-W (White Cord Pendant)
	GU2432 ^{1,2} (32W GU24 / 2700K)	DVG (Dove Gray)		-CGG (Clear Glass w/ Cast Guard)	-F (Flush Mount)
	GU2442 ^{1,2} (42W GU24 / 2700K)	FLG (Flannel Gray)		-FGG (Frosted Glass w/ Cast Guard)	
	LED1127 ^{1,3} (11W LED / 2700K / 90 CRI / 1188lm)	GA (Galvanized)		-OGG (Opal Glass w/ Cast Guard)	
	LED1130 ^{1,3} (11W LED / 3000K / 90 CRI / 1265lm)	LG (Lime Green)		-CGWC (Clear Glass w/ Wire Cage)	
	LED1135 ^{1,3} (11W LED / 3500K / 90 CRI / 1305lm)	MB (Matte Black)		-FGWC (Frosted Glass w/ Wire Cage)	
	LED1140 ^{1,3} (11W LED / 4000K / 90 CRI / 1364lm)	MBL (Midnight Blue)		-OGWC (Opal Glass w/ Wire Cage)	
	LED1527 ^{1,3} (15W LED / 2700K / 90 CRI / 1620lm)	PNA (Painted Natural Aluminum)			
	LED1530 ^{1,3} (15W LED / 3000K / 90 CRI / 1725lm)	PNC (Painted Natural Copper)			
	LED1535 ^{1,3} (15W LED / 3500K / 90 CRI / 1780lm)	RD (Red)			
	LED1540 ^{1,3} (15W LED / 4000K / 90 CRI / 1860lm)	SA (Satin Aluminum)			
		SGR (Sage Green)			
		SGW (Semi Gloss White)			
		SND (Sand)			
		SS (Satin Silver)			
		TBZ (Textured Bronze)			
		TGP (Textured Graphite)			
	TNG (Tangerine)				
	TTL (Tahitian Teal)				
	WT (Gloss White)				

1. Lamp/LED included
2. Not for use in glass/cast guard/wire cage
3. Glass enclosure must be specified

4. Satin aluminum cannot be coated



Compatible Mounts - see pages 56-58 for detailed specs

Arm Mount Order Matrix (Example: 2SL23BK)

Pipe Size	Arm Type	Finish	Coastal Coating	Input Voltage
2 (1/2" IP)	SL23 (Small Loop - 23")	(Specify finish - see available finishes on right)	(blank) (No coating)	(blank) (120V)
3 (3/4" IP)	SL30 (Small Loop - 30")		-C ⁴ (Coating)	-27 (277V)
	LL23 (Large Loop - 23")			
	LL30 (Large Loop - 30")			
	LC18 (Curve Arm - 18")			
	LC24 (Curve Arm - 24")			
	LC30 (Curve Arm - 30")			
	LM18 (Miter Arm - 18")			
	LM24 (Miter Arm - 24")			
	LM30 (Miter Arm - 30")			
	SA18 (Sign Arm - 18")			
	SA23 (Sign Arm - 23")			
	LSA23 (Large Loop Sign Arm - 23")			
	LSA30 (Large Loop Sign Arm - 30")			
	A6 (Straight Arm - 6")			
	A12 (Straight Arm - 12")			
	A18 (Straight Arm - 18")			
	A24 (Straight Arm - 24")			
	A30 (Straight Arm - 30")			
	MA18 (Modern Arm - 18")			
	MA24 (Modern Arm - 24")			
	MA30 (Modern Arm - 30")			

4. Satin aluminum cannot be coated

Knuckle Accessory Order Matrix (Example: 2KNLBK)

Pipe Size	Knuckle	Finish	Coastal Coating
2 (1/2" IP)	KNL (Adjustable 180° Knuckle for Arm Mounts)	(Specify finish - see available finishes on right)	(blank) (No coating)
3 (3/4" IP)			-C ⁴ (Coating)

4. Satin aluminum cannot be coated

Post / Wall Mount Order Matrix (Example: 2W1BK)

Pipe Size	Mount Type	Finish	Input Voltage
2 (1/2" IP)	P1 (Single Post Mount)	(Specify finish - see available finishes on right)	(blank) (120V)
	P2 (Double Post Mount)		-27 ⁵ (277V)
	W1 (Traditional Wall Mount)		

5. Post mount only

Post Type Order Matrix (Example: P8683-96BK)

Post Type	Finish
PM4946 (Cast Aluminum Post)	(Specify finish - see available finishes on right)
P8683-96 (Cast Aluminum Base w/ 96" Aluminum Post)	
P8683-120 (Cast Aluminum Base w/ 120" Aluminum Post)	
P8684-96 (96" Straight Aluminum Post)	
P8684-120 (120" Straight Aluminum Post)	
PM8685 (Cast Aluminum Pier Mount - must be used with straight aluminum post, P8683)	

Stem Mount Order Matrix (Example: 2HS18BK)

Pipe Size	Stem Length	Finish	Coastal Coating
2 (1/2" IP)	HS12 (12")	(Specify finish - see available finishes on right)	(blank) (No coating)
	HS18 (18")		-C ⁴ (Coating)
	HS24 (24")		
	HS36 (36")		
	HS48 (48")		
	HS__ (Custom length from 2" up to 60")		

4. Satin aluminum cannot be coated

Finishes	
	ABL (Aegean Blue)
	BB (Burnished Bronze)
	BK (Gloss Black)
	BLU (Blue)
	DVG (Dove Gray)
	FLG (Flannel Gray)
	GA^{6,7} (Galvanized)
	LG (Lime Green)
	MB (Matte Black)
	MBL (Midnight Blue)
	PNA (Painted Natural Aluminum)
	PNC (Painted Natural Copper)
	RD (Red)
	SA^{4,6,7} (Satin Aluminum)
	SGR (Sage Green)
	SGW (Semi Gloss White)
	SND (Sand)
	SS (Satin Silver)
	TBZ (Textured Bronze)
	TGP (Textured Graphite)
	TNG (Tangerine)
	TTL (Tahitian Teal)
	WT (Gloss White)

4. Satin aluminum cannot be coastal coated
 6. Post mount cannot be painted with specialty finishes
 7. Specialty Finish

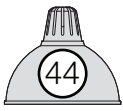

RDX

Electrical

- 120V input (277V available in arm and post option only)
- Integrated power supply allows the fixture to be connected directly into line voltage
- Pre-wired and ready for install
- LED is dimmable with Incandescent/Triac dimmers

Mounting

- 1/2" or 3/4" IP for arms. Flush mount, stems and post available only in 1/2", see next page
- 9' Pendant cord available in black or white cord (includes 5" canopy with the same finish as the shade)

Finishes

- Two toned shade and top option
- Available in 21 standard and 2 specialty finishes with optional coastal coating to protect finish in coastal environments (add "-C" to the finish)
- Inner shade is painted gloss white
- Consult factory for custom finish options

Optional Accessories

- Glass or Cast Guard options available, see page 57

Listing

UL listed to US and Canadian standards for wet locations



RDX18LED3627ABLSGW-3 / 3LL23SGW

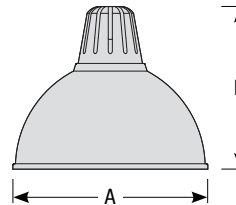

	A	B
RDX18	18"	15"
RDX20	20"	15-1/2"

RDX Order Matrix (Example: RDX18LED3627ABLSGW-3)

Diameter	Lamp / LED	Shade Finish	Top Finish	Coastal Coating	Accessories	Mounting Type
RDX18 (18")	M (Medium Base, 100W max.)	ABL (Aegean Blue)	ABL	(blank) (No coating)	(blank) (No accessories)	-2 (1/2" IP)
RDX20 (20")	GU2413 ¹ (13W GU24 / 2700K)	BB (Burnished Bronze)	BB	-C⁴ (Coating)	-CG (Clear Glass)	-3 (3/4" IP)
	GU2418 ¹ (18W GU24 / 2700K)	BK (Gloss Black)	BK		-FG (Frosted Glass)	-B (Black Cord Pendant)
	GU2426 ¹ (26W GU24 / 2700K)	BLU (Blue)	BLU		-OG (Opal Glass)	-W (White Cord Pendant)
	GU2432 ^{1,2} (32W GU24 / 2700K)	DVG (Dove Gray)	DVG		-CGG (Clear Glass w/ Cast Guard)	-F (Flush Mount)
	GU2442 ^{1,2} (42W GU24 / 2700K)	FLG (Flannel Gray)	FLG		-FGG (Frosted Glass w/ Cast Guard)	
	LED1127 ^{1,3} (11W LED / 2700K / 90 CRI / 1188lm)	GA (Galvanized)	GA		-OGG (Opal Glass w/ Cast Guard)	
	LED1130 ^{1,3} (11W LED / 3000K / 90 CRI / 1265lm)	LG (Lime Green)	LG			
	LED1135 ^{1,3} (11W LED / 3500K / 90 CRI / 1305lm)	MB (Matte Black)	MB			
	LED1140 ^{1,3} (11W LED / 4000K / 90 CRI / 1364lm)	MBL (Midnight Blue)	MBL			
	LED1527 ^{1,3} (15W LED / 2700K / 90 CRI / 1620lm)	PNA (Painted Natural Aluminum)	PNA			
	LED1530 ^{1,3} (15W LED / 3000K / 90 CRI / 1725lm)	PNC (Painted Natural Copper)	PNC			
	LED1535 ^{1,3} (15W LED / 3500K / 90 CRI / 1780lm)	RD (Red)	RD			
	LED1540 ^{1,3} (15W LED / 4000K / 90 CRI / 1860lm)	SA (Satin Aluminum)	SA			
	LED2427 ^{1,3} (24W LED / 2700K / 90 CRI / 1840lm)	SGR (Sage Green)	SGR			
	LED2430 ^{1,3} (24W LED / 3000K / 90 CRI / 1920lm)	SGW (Semi Gloss White)	SGW			
	LED2435 ^{1,3} (24W LED / 3500K / 90 CRI / 2000lm)	SND (Sand)	SND			
	LED2440 ^{1,3} (24W LED / 4000K / 90 CRI / 2080lm)	SS (Satin Silver)	SS			
	LED3627 ^{1,3} (36W LED / 2700K / 90 CRI / 2470lm)	TBZ (Textured Bronze)	TBZ			
	LED3630 ^{1,3} (36W LED / 3000K / 90 CRI / 2595lm)	TGP (Textured Graphite)	TGP			
	LED3635 ^{1,3} (36W LED / 3500K / 90 CRI / 2720lm)	TNG (Tangerine)	TNG			
	LED3640 ^{1,3} (36W LED / 4000K / 90 CRI / 2845lm)	TTL (Tahitian Teal)	TTL			
		WT (Gloss White)	WT			

1. Lamp/LED included
 2. Not for use in glass/cast guard/wire cage
 3. Glass enclosure must be specified

4. Satin aluminum cannot be coated



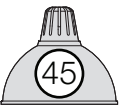

Compatible Mounts - see pages 56-58 for detailed specs

Arm Mount Order Matrix (Example: 3SL23SGW)

Pipe Size	Arm Type	Finish	Coastal Coating	Input Voltage
2 (1/2" IP)	SL23 (Small Loop- 23")	(Specify finish - see available finishes on right)	(blank) (No coating)	(blank) (120V)
3 (3/4" IP)	SL30 (Small Loop- 30")		-C ⁴ (Coating)	-27 (277V)
	LL23 (Large Loop - 23")			
	LL30 (Large Loop - 30")			
	LC18 (Curve Arm - 18")			
	LC24 (Curve Arm - 24")			
	LC30 (Curve Arm - 30")			
	LM18 (Miter Arm - 18")			
	LM24 (Miter Arm - 24")			
	LM30 (Miter Arm - 30")			
	SA18 (Sign Arm - 18")			
	SA23 (Sign Arm - 23")			
	LSA23 (Large Loop Sign Arm - 23")			
	LSA30 (Large Loop Sign Arm - 30")			
	A6 (Straight Arm - 6")			
	A12 (Straight Arm - 12")			
	A18 (Straight Arm - 18")			
	A24 (Straight Arm - 24")			
	A30 (Straight Arm - 30")			
	MA18 (Modern Arm - 18")			
	MA24 (Modern Arm - 24")			
	MA30 (Modern Arm - 30")			

4. Satin aluminum cannot be coated

Knuckle Accessory Order Matrix (Example: 2KNLSGW)

Pipe Size	Knuckle	Finish	Coastal Coating
2 (1/2" IP)	KNL (Adjustable 180° Knuckle for Arm Mounts)	(Specify finish - see available finishes on right)	(blank) (No coating)
3 (3/4" IP)			-C ⁴ (Coating)

4. Satin aluminum cannot be coated

Post / Wall Mount Order Matrix (Example: 2W1SGW)

Pipe Size	Mount Type	Finish	Input Voltage
2 (1/2" IP)	P1 (Single Post Mount)	(Specify finish - see available finishes on right)	(blank) (120V)
	P2 (Double Post Mount)		-27 ⁵ (277V)
	W1 (Traditional Wall Mount)		

5. Post mount only

Post Type Order Matrix (Example: P8683-96SGW)

Post Type	Finish
PM4946 (Cast Aluminum Post)	(Specify finish - see available finishes on right)
P8683-96 (Cast Aluminum Base w/ 96" Aluminum Post)	
P8683-120 (Cast Aluminum Base w/ 120" Aluminum Post)	
P8684-96 (96" Straight Aluminum Post)	
P8684-120 (120" Straight Aluminum Post)	
PM8685 (Cast Aluminum Pier Mount - must be used with straight aluminum post, P8683)	

Stem Mount Order Matrix (Example: 2HS18SGW)

Pipe Size	Stem Length	Finish	Coastal Coating
2 (1/2" IP)	HS12 (12")	(Specify finish - see available finishes on right)	(blank) (No coating)
	HS18 (18")		-C ⁴ (Coating)
	HS24 (24")		
	HS36 (36")		
	HS48 (48")		
	HS__ (Custom length from 2" up to 60")		

4. Satin aluminum cannot be coated

Finishes	
	ABL (Aegean Blue)
	BB (Burnished Bronze)
	BK (Gloss Black)
	BLU (Blue)
	DVG (Dove Gray)
	FLG (Flannel Gray)
	GA^{6,7} (Galvanized)
	LG (Lime Green)
	MB (Matte Black)
	MBL (Midnight Blue)
	PNA (Painted Natural Aluminum)
	PNC (Painted Natural Copper)
	RD (Red)
	SA^{4,6,7} (Satin Aluminum)
	SGR (Sage Green)
	SGW (Semi Gloss White)
	SND (Sand)
	SS (Satin Silver)
	TBZ (Textured Bronze)
	TGP (Textured Graphite)
	TNG (Tangerine)
	TTL (Tahitian Teal)
	WT (Gloss White)

4. Satin aluminum cannot be coastal coated
 6. Post mount cannot be painted with specialty finishes
 7. Specialty Finish



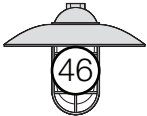

RETRO INDUSTRIAL

Electrical

- 120V input (277V available in arm and post option only)
- Integrated power supply allows the fixture to be connected directly into line voltage
- Pre-wired and ready for install
- LED is dimmable with Incandescent/Triac dimmers

Mounting

- 1/2" IP for arm, ceiling flush mount, stem or post mount options, see next page
- 9' Pendant cord available in black or white cord (includes 5" canopy with the same finish as the shade)

Finishes

- Shade and mounting finish options
- Available in 21 standard and 2 specialty finishes with optional coastal coating to protect finish in coastal environments (add "-C" to the finish)
- Consult factory for custom finish options

Glass Type

- Each luminaire includes a glass enclosure, must specify glass type. Glass is available in clear (-CG), frosted (-FG) or opal (-OG)

Listing

UL listed to US and Canadian standards for wet locations



RRS10MPNA-CG-2 / 2SL23PNA



RID13MRD-CG-2 / 2A24RD

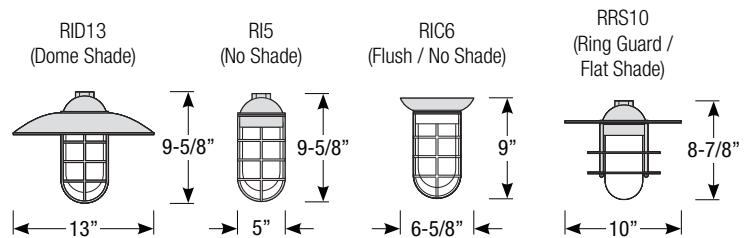

Retro Industrial Order Matrix (Example: RID13MRD-CG-2)

Shade Style	Lamp / LED	Finish	Coastal Coating	Glass Type	Mounting Type
RID13 (Dome Shade)	M (Medium Base, 100W max.)	ABL (Aegean Blue)	(blank) (No coating)	-CG (Clear Glass)	-2 (1/2" IP)
RI5 (No Shade)	GU2413¹ (13W GU24 / 2700K)	BB (Burnished Bronze)	-C² (Coating)	-FG (Frosted Glass)	-B (Black Cord Pendant)
RIC6 (Flush / No Shade)	GU2418¹ (18W GU24 / 2700K)	BK (Gloss Black)		-OG (Opal Glass)	-W (White Cord Pendant)
RRS10 (Ring Guard / Flat Shade)	GU2426¹ (26W GU24 / 2700K)	BLU (Blue)			-F (Flush Mount)
	LED1127¹ (11W LED / 2700K / 90 CRI / 1188lm)	DVG (Dove Gray)			
	LED1130¹ (11W LED / 3000K / 90 CRI / 1265lm)	FLG (Flannel Gray)			
	LED1135¹ (11W LED / 3500K / 90 CRI / 1305lm)	GA (Galvanized)			
	LED1140¹ (11W LED / 4000K / 90 CRI / 1364lm)	LG (Lime Green)			
		MB (Matte Black)			
		MBL (Midnight Blue)			
		PNA (Painted Natural Aluminum)			
		PNC (Painted Natural Copper)			
		RD (Red)			
		SA (Satin Aluminum)			
		SGR (Sage Green)			
		SGW (Semi Gloss White)			
		SND (Sand)			
		SS (Satin Silver)			
		TBZ (Textured Bronze)			
		TGP (Textured Graphite)			
		TNG (Tangerine)			
		TTL (Tahitian Teal)			
		WT (Gloss White)			

1. Lamp/LED included

2. Satin aluminum cannot be coated





Compatible Mounts - see pages 56-58 for detailed specs

Arm Mount Order Matrix (Example: 2A24RD)

Pipe Size	Arm Type	Finish	Coastal Coating	Input Voltage	
2 (1/2" IP)	SL23 (Small Loop- 23")	(Specify finish - see available finishes on right)	(blank) (No coating)	(blank) (120V)	
	SL30 (Small Loop- 30")		-C ² (Coating)	-27 (277V)	
	LL23 (Large Loop - 23")				
	LL30 (Large Loop - 30")				
	LC18 (Curve Arm - 18")				
	LC24 (Curve Arm - 24")				
	LC30 (Curve Arm - 30")				
	LM18 (Miter Arm - 18")				
	LM24 (Miter Arm - 24")				
	LM30 (Miter Arm - 30")				
	SA18 (Sign Arm - 18")				
	SA23 (Sign Arm - 23")				
	LSA23 (Large Loop Sign Arm - 23")				
	LSA30 (Large Loop Sign Arm - 30")				
	A6 (Straight Arm - 6")				
	A12 (Straight Arm - 12")				
	A18 (Straight Arm - 18")				
	A24 (Straight Arm - 24")				
	A30 (Straight Arm - 30")				
	MA18 (Modern Arm - 18")				
MA24 (Modern Arm - 24")					
MA30 (Modern Arm - 30")					

2. Satin aluminum cannot be coated

Knuckle Accessory Order Matrix (Example: 2KNLRD)

Pipe Size	Knuckle	Finish	Coastal Coating
2 (1/2" IP)	KNL (Adjustable 180° Knuckle for Arm Mounts)	(Specify finish - see available finishes on right)	(blank) (No coating) -C ² (Coating)

2. Satin aluminum cannot be coated

Post / Wall Mount Order Matrix (Example: 2P1RD)

Pipe Size	Mount Type	Finish	Input Voltage
2 (1/2" IP)	P1 (Single Post Mount)	(Specify finish - see available finishes on right)	(blank) (120V)
	P2 (Double Post Mount)		-27 ³ (277V)
	W1 (Traditional Wall Mount)		

3. Post mount only























Post Type Order Matrix (Example: P8683-96RD)

Post Type	Finish
PM4946 (Cast Aluminum Post)	(Specify finish - see available finishes on right)
P8683-96 (Cast Aluminum Base w/ 96" Aluminum Post)	
P8683-120 (Cast Aluminum Base w/ 120" Aluminum Post)	
P8684-96 (96" Straight Aluminum Post)	
P8684-120 (120" Straight Aluminum Post)	
PM8685 (Cast Aluminum Pier Mount - must be used with straight aluminum post, P8683)	

Stem Mount Order Matrix (Example: 2HS18RD)

Pipe Size	Stem Length	Finish	Coastal Coating
2 (1/2" IP)	HS12 (12")	(Specify finish - see available finishes on right)	(blank) (No coating)
	HS18 (18")		-C ² (Coating)
	HS24 (24")		
	HS36 (36")		
	HS48 (48")		
	HS__ (Custom length from 2" up to 60")		

2. Satin aluminum cannot be coated

Finishes	
	ABL (Aegean Blue)
	BB (Burnished Bronze)
	BK (Gloss Black)
	BLU (Blue)
	DVG (Dove Gray)
	FLG (Flannel Gray)
	GA^{4,5} (Galvanized)
	LG (Lime Green)
	MB (Matte Black)
	MBL (Midnight Blue)
	PNA (Painted Natural Aluminum)
	PNC (Painted Natural Copper)
	RD (Red)
	SA^{2,4,5} (Satin Aluminum)
	SGR (Sage Green)
	SGW (Semi Gloss White)
	SND (Sand)
	SS (Satin Silver)
	TBZ (Textured Bronze)
	TGP (Textured Graphite)
	TNG (Tangerine)
	TTL (Tahitian Teal)
	WT (Gloss White)

2. Satin aluminum cannot be coastal coated
4. Post mount cannot be painted with specialty finishes
5. Specialty finish

SHALLOW HEAVY DUTY

Electrical

- 120V input (277V available in arm and post option only)
- Integrated power supply allows the fixture to be connected directly into line voltage
- Pre-wired and ready for install
- LED is dimmable with Incandescent/Triac dimmers

Mounting

- 1/2" or 3/4" IP for arms. Flush mount, stems and post available only in 1/2", see next page
- 9' Pendant cord available in black or white cord (includes 5" canopy with the same finish as the shade)

Finishes

- Shade and mounting finish options
- Available in 21 standard and 2 specialty finishes with optional coastal coating to protect finish in coastal environments (add "-C" to the finish)
- Inner shade is painted gloss white
- Consult factory for custom finish options

Optional Accessories

- Glass, Cast Guard, Wire Cage or Wire Guard options available, see page 57

Listing

UL listed to US and Canadian standards for wet locations



RHS14LED1530BB-2 / 2HS36BB

RHS16GU2426RD-OGG-3 / 3LL23RD

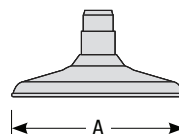

	A	B
RHS14	14"	8-1/2"
RHS16	16"	9"

Shallow Heavy Duty Order Matrix (Example: RHS16GU2426RD-OGG-3)

Diameter	Lamp / LED	Finish	Coastal Coating	Accessories	Mounting Type
RHS14 (14")	M (Medium Base, 100W max.)	ABL (Aegean Blue)	(blank) (No coating)	(blank) (No accessories)	-2 (1/2" IP)
RHS16 (16")	GU2413¹ (13W GU24 / 2700K)	BB (Burnished Bronze)	-C⁴ (Coating)	-CG (Clear Glass)	-3 (3/4" IP)
	GU2418¹ (18W GU24 / 2700K)	BK (Gloss Black)		-FG (Frosted Glass)	-B (Black Cord Pendant)
	GU2426¹ (26W GU24 / 2700K)	BLU (Blue)		-OG (Opal Glass)	-W (White Cord Pendant)
	GU2432^{1,2} (32W GU24 / 2700K)	DVG (Dove Gray)		-CGG (Clear Glass w/ Cast Guard)	-F (Flush Mount)
	GU2442^{1,2} (42W GU24 / 2700K)	FLG (Flannel Gray)		-FGG (Frosted Glass w/ Cast Guard)	
	LED1127^{1,3} (11W LED / 2700K / 90 CRI / 1188lm)	GA (Galvanized)		-OGG (Opal Glass w/ Cast Guard)	
	LED1130^{1,3} (11W LED / 3000K / 90 CRI / 1265lm)	LG (Lime Green)		-CGWC (Clear Glass w/ Wire Cage)	
	LED1135^{1,3} (11W LED / 3500K / 90 CRI / 1305lm)	MB (Matte Black)		-FGWC (Frosted Glass w/ Wire Cage)	
	LED1140^{1,3} (11W LED / 4000K / 90 CRI / 1364lm)	MBL (Midnight Blue)		-OGWC (Opal Glass w/ Wire Cage)	
	LED1527^{1,3} (15W LED / 2700K / 90 CRI / 1620lm)	PNA (Painted Natural Aluminum)		-WG (Wire Guard)	
	LED1530^{1,3} (15W LED / 3000K / 90 CRI / 1725lm)	PNC (Painted Natural Copper)			
	LED1535^{1,3} (15W LED / 3500K / 90 CRI / 1780lm)	RD (Red)			
	LED1540^{1,3} (15W LED / 4000K / 90 CRI / 1860lm)	SA (Satin Aluminum)			
		SGR (Sage Green)			
		SGW (Semi Gloss White)			
		SND (Sand)			
		SS (Satin Silver)			
	TBZ (Textured Bronze)				
	TGP (Textured Graphite)				
	TNG (Tangerine)				
	TTL (Tahitian Teal)				
	WT (Gloss White)				

1. Lamp/LED included
2. Not for use in glass/cast guard/wire cage
3. Glass enclosure must be specified

4. Satin aluminum cannot be coated



Compatible Mounts - see pages 56-58 for detailed specs

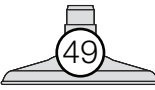

Arm Mount Order Matrix (Example: 3LL23RD)

Pipe Size	Arm Type	Finish	Coastal Coating	Input Voltage	
2 (1/2" IP)	SL23 (Small Loop- 23")	(Specify finish - see available finishes on right)	(blank) (No coating)	(blank) (120V)	
3 (3/4" IP)	SL30 (Small Loop- 30")		-C ⁴ (Coating)	-27 (277V)	
	LL23 (Large Loop - 23")				
	LL30 (Large Loop - 30")				
	LC18 (Curve Arm - 18")				
	LC24 (Curve Arm - 24")				
	LC30 (Curve Arm - 30")				
	LM18 (Miter Arm - 18")				
	LM24 (Miter Arm - 24")				
	LM30 (Miter Arm - 30")				
	SA18 (Sign Arm - 18")				
	SA23 (Sign Arm - 23")				
	LSA23 (Large Loop Sign Arm - 23")				
	LSA30 (Large Loop Sign Arm - 30")				
	A6 (Straight Arm - 6")				
	A12 (Straight Arm - 12")				
	A18 (Straight Arm - 18")				
	A24 (Straight Arm - 24")				
	A30 (Straight Arm - 30")				
	MA18 (Modern Arm - 18")				
	MA24 (Modern Arm - 24")				
	MA30 (Modern Arm - 30")				

4. Satin aluminum cannot be coated

Knuckle Accessory Order Matrix (Example: 2KNLRD)

Pipe Size	Knuckle	Finish	Coastal Coating
2 (1/2" IP)	KNL (Adjustable 180° Knuckle for Arm Mounts)	(Specify finish - see available finishes on right)	(blank) (No coating)
3 (3/4" IP)			-C ⁴ (Coating)

4. Satin aluminum cannot be coated

Post / Wall Mount Order Matrix (Example: 2W1RD)

Pipe Size	Mount Type	Finish	Input Voltage
2 (1/2" IP)	P1 (Single Post Mount)	(Specify finish - see available finishes on right)	(blank) (120V)
	P2 (Double Post Mount)		-27 ⁵ (277V)
	W1 (Traditional Wall Mount)		

5. Post mount only

Post Type Order Matrix (Example: P8683-96RD)

Post Type	Finish
PM4946 (Cast Aluminum Post)	(Specify finish - see available finishes on right)
P8683-96 (Cast Aluminum Base w/ 96" Aluminum Post)	
P8683-120 (Cast Aluminum Base w/ 120" Aluminum Post)	
P8684-96 (96" Straight Aluminum Post)	
P8684-120 (120" Straight Aluminum Post)	
PM8685 (Cast Aluminum Pier Mount - must be used with straight aluminum post, P8683)	

Stem Mount Order Matrix (Example: 2HS18RD)

Pipe Size	Stem Length	Finish	Coastal Coating
2 (1/2" IP)	HS12 (12")	(Specify finish - see available finishes on right)	(blank) (No coating)
	HS18 (18")		-C ⁴ (Coating)
	HS24 (24")		
	HS36 (36")		
	HS48 (48")		
	HS__ (Custom length from 2" up to 60")		

4. Satin aluminum cannot be coated

Finishes	
	ABL (Aegean Blue)
	BB (Burnished Bronze)
	BK (Gloss Black)
	BLU (Blue)
	DVG (Dove Gray)
	FLG (Flannel Gray)
	GA^{6,7} (Galvanized)
	LG (Lime Green)
	MB (Matte Black)
	MBL (Midnight Blue)
	PNA (Painted Natural Aluminum)
	PNC (Painted Natural Copper)
	RD (Red)
	SA^{4,6,7} (Satin Aluminum)
	SGR (Sage Green)
	SGW (Semi Gloss White)
	SND (Sand)
	SS (Satin Silver)
	TBZ (Textured Bronze)
	TGP (Textured Graphite)
	TNG (Tangerine)
	TTL (Tahitian Teal)
	WT (Gloss White)

4. Satin aluminum cannot be coastal coated
 6. Post mount cannot be painted with specialty finishes
 7. Specialty Finish



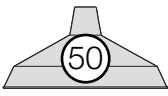

STANDARD

Electrical

- 120V input (277V available in arm and post option only)
- Integrated power supply allows the fixture to be connected directly into line voltage
- Pre-wired and ready for install
- LED is dimmable with Incandescent/Triac dimmers

Mounting

- 1/2" or 3/4" IP for arms. Flush mount, stems and post available only in 1/2", see next page
- 9' Pendant cord available in black or white cord (includes 5" canopy with the same finish as the shade)

Finishes

- Shade and mounting finish options
- Available in 21 standard and 2 specialty finishes with optional coastal coating to protect finish in coastal environments (add "-C" to the finish)
- Inner shade is painted gloss white
- Consult factory for custom finish options

Optional Accessories

- Glass, Cast Guard, Wire Cage or Wire Guard options available, see page 57

Listing

UL listed to US and Canadian standards for wet locations



RS16MBK-2 / 2W1BK

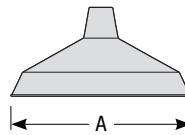

	A	B
RS16	16"	7-3/4"

Standard Order Matrix (Example: RS16MBK-2)

Diameter	Lamp / LED	Finish	Coastal Coating	Accessories	Mounting Type
RS16 (16")	M (Medium Base, 100W max.)	ABL (Aegean Blue)	(blank) (No coating)	(blank) (No accessories)	-2 (1/2" IP)
	GU2413 ¹ (13W GU24 / 2700K)	BB (Burnished Bronze)	-C ⁴ (Coating)	-CG (Clear Glass)	-3 (3/4" IP)
	GU2418 ¹ (18W GU24 / 2700K)	BK (Gloss Black)		-FG (Frosted Glass)	-B (Black Cord Pendant)
	GU2426 ¹ (26W GU24 / 2700K)	BLU (Blue)		-OG (Opal Glass)	-W (White Cord Pendant)
	GU2432 ^{1,2} (32W GU24 / 2700K)	DVG (Dove Gray)		-CGG (Clear Glass w/ Cast Guard)	-F (Flush Mount)
	GU2442 ^{1,2} (42W GU24 / 2700K)	FLG (Flannel Gray)		-FGG (Frosted Glass w/ Cast Guard)	
	LED1127 ^{1,3} (11W LED / 2700K / 90 CRI / 1188lm)	GA (Galvanized)		-OGG (Opal Glass w/ Cast Guard)	
	LED1130 ^{1,3} (11W LED / 3000K / 90 CRI / 1265lm)	LG (Lime Green)		-CGWC (Clear Glass w/ Wire Cage)	
	LED1135 ^{1,3} (11W LED / 3500K / 90 CRI / 1305lm)	MB (Matte Black)		-FGWC (Frosted Glass w/ Wire Cage)	
	LED1140 ^{1,3} (11W LED / 4000K / 90 CRI / 1364lm)	MBL (Midnight Blue)		-OGWC (Opal Glass w/ Wire Cage)	
	LED1527 ^{1,3} (15W LED / 2700K / 90 CRI / 1620lm)	PNA (Painted Natural Aluminum)		-WG (Wire Guard)	
	LED1530 ^{1,3} (15W LED / 3000K / 90 CRI / 1725lm)	PNC (Painted Natural Copper)			
	LED1535 ^{1,3} (15W LED / 3500K / 90 CRI / 1780lm)	RD (Red)			
	LED1540 ^{1,3} (15W LED / 4000K / 90 CRI / 1860lm)	SA (Satin Aluminum)			
		SGR (Sage Green)			
		SGW (Semi Gloss White)			
		SND (Sand)			
		SS (Satin Silver)			
		TBZ (Textured Bronze)			
		TGP (Textured Graphite)			
	TNG (Tangerine)				
	TTL (Tahitian Teal)				
	WT (Gloss White)				

1. Lamp/LED included
 2. Not for use in glass/cast guard/wire cage
 3. Glass enclosure must be specified

4. Satin aluminum cannot be coated



Compatible Mounts - see pages 56-58 for detailed specs

Arm Mount Order Matrix (Example: 3SL23BK)

Pipe Size	Arm Type	Finish	Coastal Coating	Input Voltage
2 (1/2" IP)	SL23 (Small Loop - 23")	(Specify finish - see available finishes on right)	(blank) (No coating)	(blank) (120V)
3 (3/4" IP)	SL30 (Small Loop - 30")		-C ⁴ (Coating)	-27 (277V)
	LL23 (Large Loop - 23")			
	LL30 (Large Loop - 30")			
	LC18 (Curve Arm - 18")			
	LC24 (Curve Arm - 24")			
	LC30 (Curve Arm - 30")			
	LM18 (Miter Arm - 18")			
	LM24 (Miter Arm - 24")			
	LM30 (Miter Arm - 30")			
	SA18 (Sign Arm - 18")			
	SA23 (Sign Arm - 23")			
	LSA23 (Large Loop Sign Arm - 23")			
	LSA30 (Large Loop Sign Arm - 30")			
	A6 (Straight Arm - 6")			
	A12 (Straight Arm - 12")			
	A18 (Straight Arm - 18")			
	A24 (Straight Arm - 24")			
	A30 (Straight Arm - 30")			
	MA18 (Modern Arm - 18")			
	MA24 (Modern Arm - 24")			
	MA30 (Modern Arm - 30")			

4. Satin aluminum cannot be coated

Knuckle Accessory Order Matrix (Example: 2KNLBK)

Pipe Size	Knuckle	Finish	Coastal Coating
2 (1/2" IP)	KNL (Adjustable 180° Knuckle for Arm Mounts)	(Specify finish - see available finishes on right)	(blank) (No coating)
3 (3/4" IP)			-C ⁴ (Coating)

4. Satin aluminum cannot be coated

Post / Wall Mount Order Matrix (Example: 2W1BK)

Pipe Size	Mount Type	Finish	Input Voltage
2 (1/2" IP)	P1 (Single Post Mount)	(Specify finish - see available finishes on right)	(blank) (120V)
	P2 (Double Post Mount)		-27 ⁵ (277V)
	W1 (Traditional Wall Mount)		

5. Post mount only

Post Type Order Matrix (Example: P8683-96BK)

Post Type	Finish
PM4946 (Cast Aluminum Post)	(Specify finish - see available finishes on right)
P8683-96 (Cast Aluminum Base w/ 96" Aluminum Post)	
P8683-120 (Cast Aluminum Base w/ 120" Aluminum Post)	
P8684-96 (96" Straight Aluminum Post)	
P8684-120 (120" Straight Aluminum Post)	
PM8685 (Cast Aluminum Pier Mount - must be used with straight aluminum post, P8683)	

Stem Mount Order Matrix (Example: 2HS18BK)

Pipe Size	Stem Length	Finish	Coastal Coating
2 (1/2" IP)	HS12 (12")	(Specify finish - see available finishes on right)	(blank) (No coating)
	HS18 (18")		-C ⁴ (Coating)
	HS24 (24")		
	HS36 (36")		
	HS48 (48")		
	HS__ (Custom length from 2" up to 60")		

4. Satin aluminum cannot be coated

Finishes	
	ABL (Aegean Blue)
	BB (Burnished Bronze)
	BK (Gloss Black)
	BLU (Blue)
	DVG (Dove Gray)
	FLG (Flannel Gray)
	GA ^{6,7} (Galvanized)
	LG (Lime Green)
	MB (Matte Black)
	MBL (Midnight Blue)
	PNA (Painted Natural Aluminum)
	PNC (Painted Natural Copper)
	RD (Red)
	SA ^{4,6,7} (Satin Aluminum)
	SGR (Sage Green)
	SGW (Semi Gloss White)
	SND (Sand)
	SS (Satin Silver)
	TBZ (Textured Bronze)
	TGP (Textured Graphite)
	TNG (Tangerine)
	TTL (Tahitian Teal)
	WT (Gloss White)

4. Satin aluminum cannot be coastal coated
 6. Post mount cannot be painted with specialty finishes
 7. Specialty Finish



TEAR

Electrical

- 120V input (277V available in arm and post option only)
- Integrated power supply allows the fixture to be connected directly into line voltage
- Pre-wired and ready for install
- LED is dimmable with Incandescent/Triac dimmers

Mounting

- 1/2" or 3/4" IP for arms. Flush mount, stems and post available only in 1/2", see next page
- 9' Pendant cord available in black or white cord (includes 5" canopy with the same finish as the shade)

Finishes

- Shade and mounting finish options
- Available in 21 standard and 2 specialty finishes with optional coastal coating to protect finish in coastal environments (add "-C" to the finish)
- Inner shade is painted semi gloss white
- Consult factory for custom finish options

Listing

UL listed to US and Canadian standards for wet locations



TR18LED1535ABL-2 / 2HS36SS

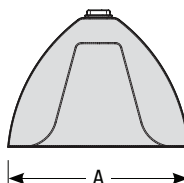

	A	B
TR12	12"	10"
TR14	14"	10"
TR16	16"	11"
TR18	18"	12"

Tear Order Matrix (Example: TR18LED1535ABL-2)

Diameter	Lamp / LED	Shade Finish	Coastal Coating	Mounting Type
TR12 (12")	M (Medium Base, 100W max.)	ABL (Aegean Blue)	(blank) (No coating)	-2 (1/2" IP)
TR14 (14")	GU2413¹ (13W GU24 / 2700K)	BB (Burnished Bronze)	-C² (Coating)	-3 (3/4" IP)
TR16 (16")	GU2418¹ (18W GU24 / 2700K)	BK (Gloss Black)		-B (Black Cord Pendant)
TR18 (18")	GU2426¹ (26W GU24 / 2700K)	BLU (Blue)		-W (White Cord Pendant)
	GU2432¹ (32W GU24 / 2700K)	DVG (Dove Gray)		-F (Flush Mount)
	GU2442¹ (42W GU24 / 2700K)	FLG (Flannel Gray)		
	LED1127¹ (11W LED / 2700K / 90 CRI / 1188lm)	GA (Galvanized)		
	LED1130¹ (11W LED / 3000K / 90 CRI / 1265lm)	LG (Lime Green)		
	LED1135¹ (11W LED / 3500K / 90 CRI / 1305lm)	MB (Matte Black)		
	LED1140¹ (11W LED / 4000K / 90 CRI / 1364lm)	MBL (Midnight Blue)		
	LED1527¹ (15W LED / 2700K / 90 CRI / 1620lm)	PNA (Painted Natural Aluminum)		
	LED1530¹ (15W LED / 3000K / 90 CRI / 1725lm)	PNC (Painted Natural Copper)		
	LED1535¹ (15W LED / 3500K / 90 CRI / 1780lm)	RD (Red)		
	LED1540¹ (15W LED / 4000K / 90 CRI / 1860lm)	SA (Satin Aluminum)		
		SGR (Sage Green)		
		SGW (Semi Gloss White)		
		SND (Sand)		
		SS (Satin Silver)		
		TBZ (Textured Bronze)		
		TGP (Textured Graphite)		
		TNG (Tangerine)		
		TTL (Tahitian Teal)		
		WT (Gloss White)		

1. Lamp/LED included

2. Satin aluminum cannot be coated



Compatible Mounts - see pages 56-58 for detailed specs



Arm Mount Order Matrix (Example: 3SL23SS)

Pipe Size	Arm Type	Finish	Coastal Coating	Input Voltage	
2 (1/2" IP)	SL23 (Small Loop- 23")	(Specify finish - see available finishes on right)	(blank) (No coating)	(blank) (120V)	
3 (3/4" IP)	SL30 (Small Loop- 30")		-C ² (Coating)	-27 (277V)	
	LL23 (Large Loop - 23")				
	LL30 (Large Loop - 30")				
	LC18 (Curve Arm - 18")				
	LC24 (Curve Arm - 24")				
	LC30 (Curve Arm - 30")				
	LM18 (Miter Arm - 18")				
	LM24 (Miter Arm - 24")				
	LM30 (Miter Arm - 30")				
	SA18 (Sign Arm - 18")				
	SA23 (Sign Arm - 23")				
	LSA23 (Large Loop Sign Arm - 23")				
	LSA30 (Large Loop Sign Arm - 30")				
	A6 (Straight Arm - 6")				
	A12 (Straight Arm - 12")				
	A18 (Straight Arm - 18")				
	A24 (Straight Arm - 24")				
	A30 (Straight Arm - 30")				
	MA18 (Modern Arm - 18")				
	MA24 (Modern Arm - 24")				
	MA30 (Modern Arm - 30")				

2. Satin aluminum cannot be coated

Knuckle Accessory Order Matrix (Example: 2KNLSS)

Pipe Size	Knuckle	Finish	Coastal Coating
2 (1/2" IP)	KNL (Adjustable 180° Knuckle for Arm Mounts)	(Specify finish - see available finishes on right)	(blank) (No coating)
3 (3/4" IP)			-C ² (Coating)

2. Satin aluminum cannot be coated

Post / Wall Mount Order Matrix (Example: 2P1SS)

Pipe Size	Mount Type	Finish	Input Voltage
2 (1/2" IP)	P1 (Single Post Mount)	(Specify finish - see available finishes on right)	(blank) (120V)
	P2 (Double Post Mount)		-27 ³ (277V)
	W1 (Traditional Wall Mount)		

3. Post mount only

Post Type Order Matrix (Example: P8683-96SS)

Post Type	Finish
PM4946 (Cast Aluminum Post)	(Specify finish - see available finishes on right)
P8683-96 (Cast Aluminum Base w/ 96" Aluminum Post)	
P8683-120 (Cast Aluminum Base w/ 120" Aluminum Post)	
P8684-96 (96" Straight Aluminum Post)	
P8684-120 (120" Straight Aluminum Post)	
PM8685 (Cast Aluminum Pier Mount - must be used with straight aluminum post, P8683)	

Stem Mount Order Matrix (Example: 2HS36SS)

Pipe Size	Stem Length	Finish	Coastal Coating
2 (1/2" IP)	HS12 (12")	(Specify finish - see available finishes on right)	(blank) (No coating)
	HS18 (18")		-C ² (Coating)
	HS24 (24")		
	HS36 (36")		
	HS48 (48")		
	HS__ (Custom length from 2" up to 60")		

2. Satin aluminum cannot be coated

FINISHES	
	ABL (Aegean Blue)
	BB (Burnished Bronze)
	BK (Gloss Black)
	BLU (Blue)
	DVG (Dove Gray)
	FLG (Flannel Gray)
	GA^{4,5} (Galvanized)
	LG (Lime Green)
	MB (Matte Black)
	MBL (Midnight Blue)
	PNA (Painted Natural Aluminum)
	PNC (Painted Natural Copper)
	RD (Red)
	SA^{2,4,5} (Satin Aluminum)
	SGR (Sage Green)
	SGW (Semi Gloss White)
	SND (Sand)
	SS (Satin Silver)
	TBZ (Textured Bronze)
	TGP (Textured Graphite)
	TNG (Tangerine)
	TTL (Tahitian Teal)
	WT (Gloss White)

2. Satin aluminum cannot be coastal coated
 4. Post mount cannot be painted with specialty finishes
 5. Specialty Finish

Standard Arm Mounts

Arm Mount Order Matrix (Example: 2LL30RD)

Pipe Size	Arm Type	Finish	Coastal Coating	Input Voltage	
2 (1/2" IP)	SL23 (Small Loop - 23")	ABL (Aegean Blue)	(blank) (No coating)	(blank) (120V)	
3 (3/4" IP)	SL30 (Small Loop - 30")	BB (Burnished Bronze)	-C' (Coating)	-27 (277V)	
	LL23 (Large Loop - 23")	BK (Gloss Black)			
	LL30 (Large Loop - 30")	BLU (Blue)			
	LC18 (Curve Arm - 18")	DVG (Dove Gray)			
	LC24 (Curve Arm - 24")	FLG (Flannel Gray)			
	LC30 (Curve Arm - 30")	GA (Galvanized)			
	LM18 (Miter Arm - 18")	LG (Lime Green)			
	LM24 (Miter Arm - 24")	MB (Matte Black)			
	LM30 (Miter Arm - 30")	MBL (Midnight Blue)			
	SA18 (Sign Arm - 18")	PNA (Painted Natural Aluminum)			
	SA23 (Sign Arm - 23")	PNC (Painted Natural Copper)			
	LSA23 (Large Loop Sign Arm - 23")	RD (Red)			
	LSA30 (Large Loop Sign Arm - 30")	SA (Satin Aluminum)			
	A6 (Straight Arm - 6")	SGR (Sage Green)			
	A12 (Straight Arm - 12")	SGW (Semi Gloss White)			
	A18 (Straight Arm - 18")	SND (Sand)			
	A24 (Straight Arm - 24")	SS (Satin Silver)			
	A30 (Straight Arm - 30")	TBZ (Textured Bronze)			
	MA18 (Modern Arm - 18")	TGP (Textured Graphite)			
	MA24 (Modern Arm - 24")	TNG (Tangerine)			
	MA30 (Modern Arm - 30")	TTL (Tahitian Teal)			
			WT (Gloss White)		

1. Satin aluminum cannot be coated

Note: All arm mounts include canopy

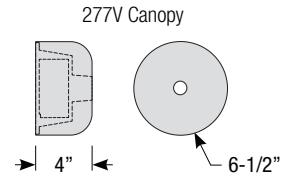
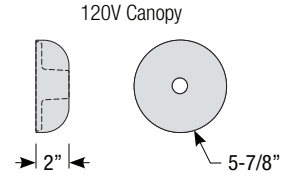

Knuckle Accessory

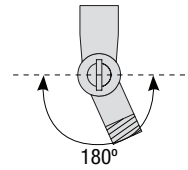

Knuckle Accessory Order Matrix (Example: 2KNLSS)

Pipe Size	Knuckle	Finish	Coastal Coating
2 (1/2" IP)	KNL (Adjustable 180° Knuckle for Arm Mounts)	(Specify same finish as arm mount)	(blank) (No coating)
3 (3/4" IP)			-C' (Coating)

1. Satin aluminum cannot be coated

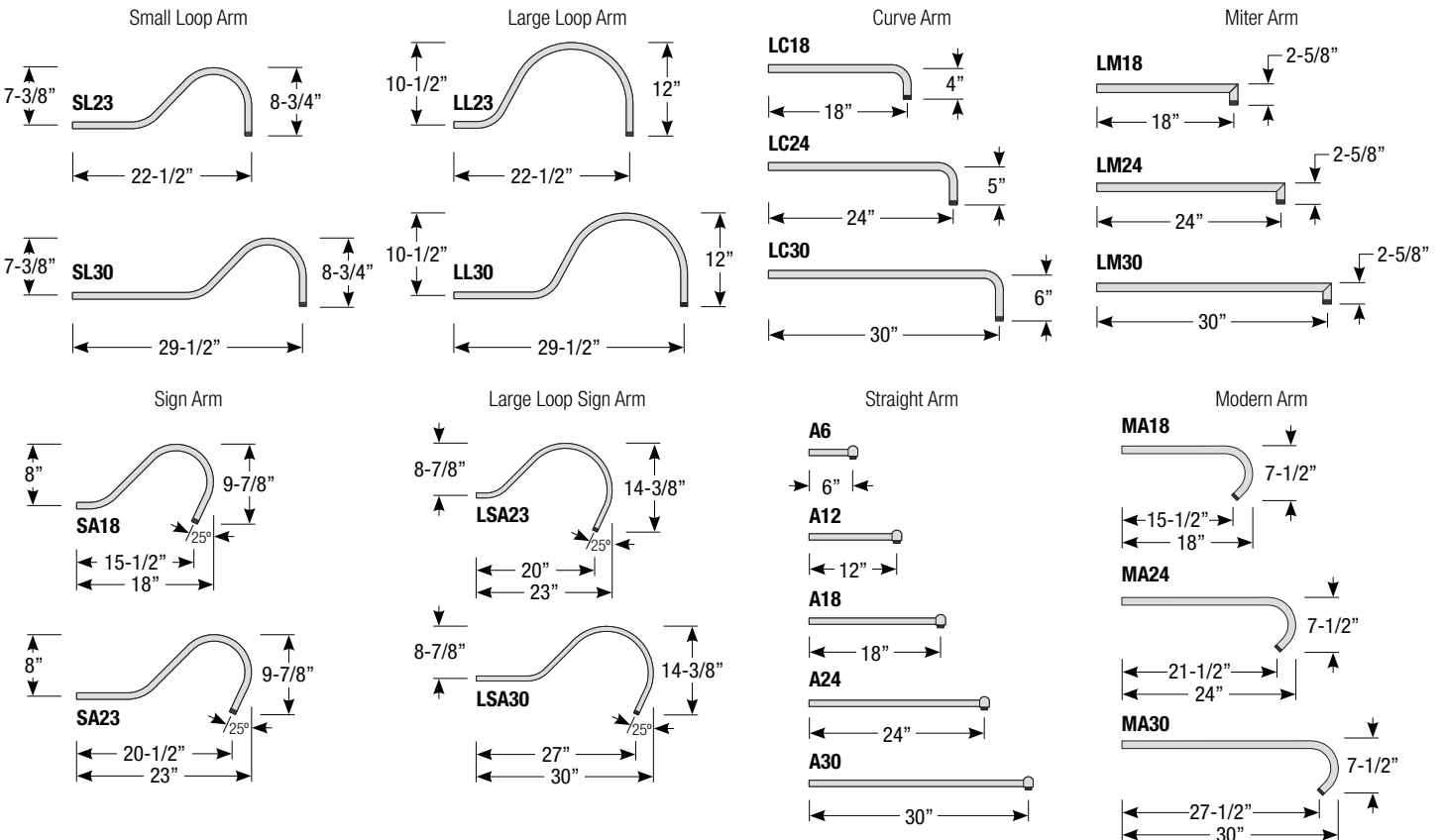

Post / Wall Mount Order Matrix (Example: 2P1RD)

Pipe Size	Mount Type	Finish	Input Voltage
2 (1/2" IP)	P1 (Single Post Mount) P2 (Double Post Mount) W1 (Traditional Wall Mount)	ABL (Aegean Blue)	(blank) (120V)
		BB (Burnished Bronze)	-27 ³ (277V)
		BK (Gloss Black)	
		BLU (Blue)	
		DVG (Dove Gray)	
		FLG (Flannel Gray)	
		GA (Galvanized)	
		LG (Lime Green)	
		MB (Matte Black)	
		MBL (Midnight Blue)	
		PNA (Painted Natural Aluminum)	
		PNC (Painted Natural Copper)	
		RD (Red)	
		SA² (Satin Aluminum)	
		SGR (Sage Green)	
		SGW (Semi Gloss White)	
SND (Sand)			
SS (Satin Silver)			
TBZ (Textured Bronze)			
TGP (Textured Graphite)			
TNG (Tangerine)			
TTL (Tahitian Teal)			
WT (Gloss White)			

2. Wall mount only

3. Post mount only

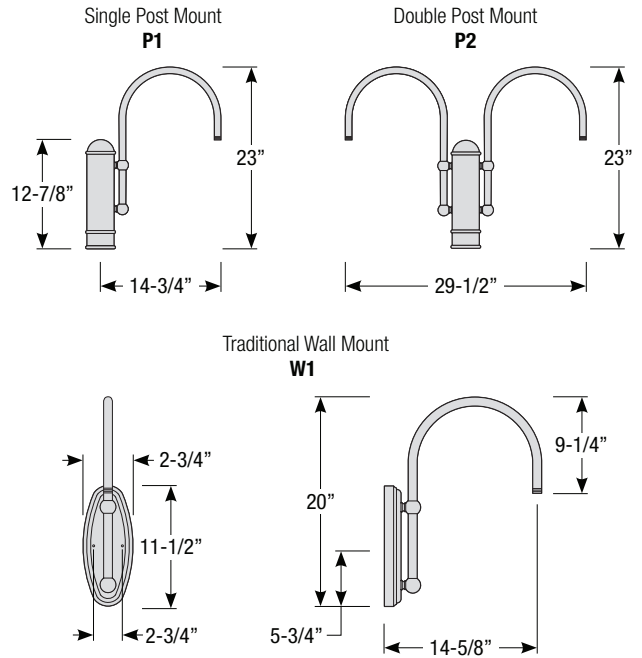

Post Type Order Matrix (Example: P8683-96RD)

Post Type	Finish
PM4946 (Cast Aluminum Post)	ABL (Aegean Blue)
P8683-96 (Cast Aluminum Base w/ 96" Aluminum Post)	BB (Burnished Bronze)
P8683-120 (Cast Aluminum Base w/ 120" Aluminum Post)	BK (Gloss Black)
P8684-96 (96" Straight Aluminum Post)	BLU (Blue)
P8684-120 (120" Straight Aluminum Post)	DVG (Dove Gray)
PM8685 (Cast Aluminum Pier Mount - must be used with straight aluminum post, P8683)	FLG (Flannel Gray)
	GA (Galvanized)
	LG (Lime Green)
	MB (Matte Black)
	MBL (Midnight Blue)
	PNA (Painted Natural Aluminum)
	PNC (Painted Natural Copper)
	RD (Red)
	SA (Satin Aluminum)
	SGR (Sage Green)
	SGW (Semi Gloss White)
	SND (Sand)
	SS (Satin Silver)
	TBZ (Textured Bronze)
	TGP (Textured Graphite)
	TNG (Tangerine)
	TTL (Tahitian Teal)
	WT (Gloss White)

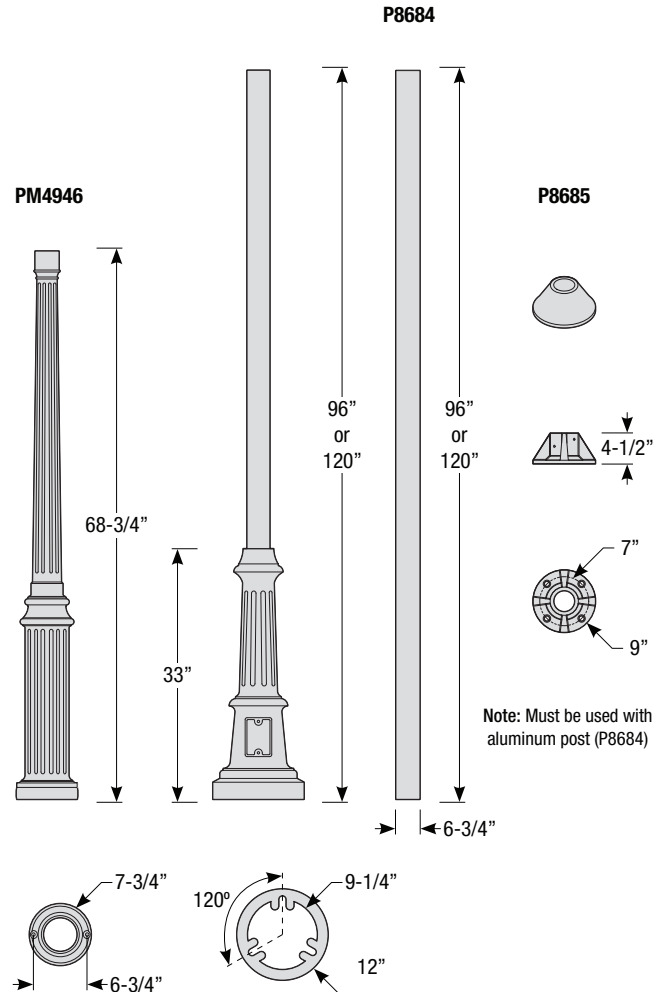

Standard Stem Mounts / Pendant & Flush Mount Canopies

Stem Mount Order Matrix (Example: 2HS18TBZ)

Pipe Size	Stem Length	Finish	Coastal Coating
2 (1/2" IP)	HS12 (12")	ABL (Aegean Blue)	(blank) (No coating)
	HS18 (18")	BB (Burnished Bronze)	-C' (Coating)
	HS24 (24")	BK (Gloss Black)	
	HS36 (36")	BLU (Blue)	
	HS48 (48")	DVG (Dove Gray)	
	HS__ (Custom length from 2" up to 60")	FLG (Flannel Gray)	
		GA (Galvanized)	
		LG (Lime Green)	
		MB (Matte Black)	
		MBL (Midnight Blue)	
		PNA (Painted Natural Aluminum)	
		PNC (Painted Natural Copper)	
		RD (Red)	
		SA (Satin Aluminum)	
		SGR (Sage Green)	
		SGW (Semi Gloss White)	
	SND (Sand)		
	SS (Satin Silver)		
	TBZ (Textured Bronze)		
	TGP (Textured Graphite)		
	TNG (Tangerine)		
	TTL (Tahitian Teal)		
	WT (Gloss White)		

1. Satin aluminum cannot be coated

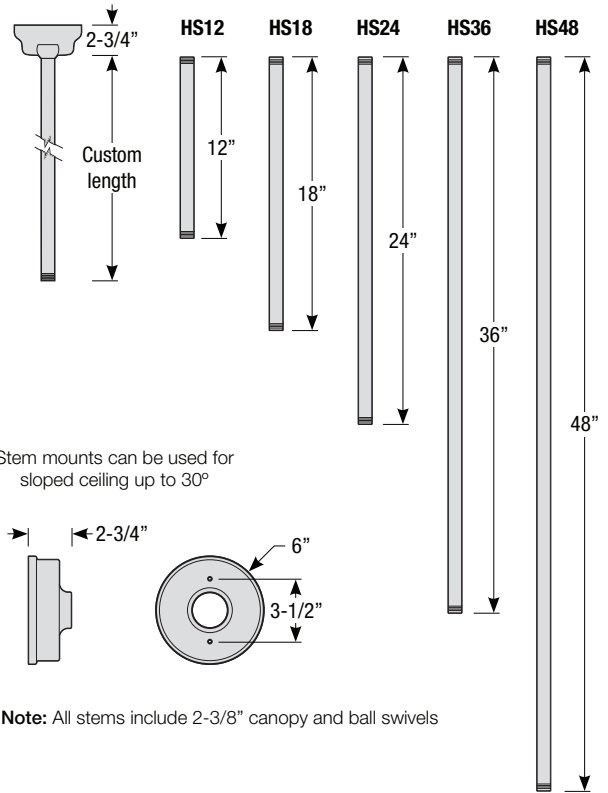

Note: All stems include 2-3/8" canopy and ball swivels

Ceiling Flush Mount Canopy

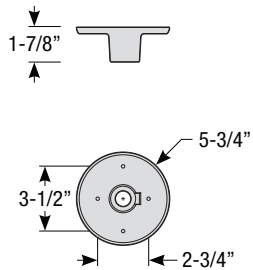

Note: Ceiling flush mount canopy includes 2" stem

Pendant Canopy

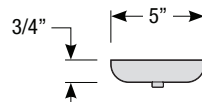

Glass Enclosure

- Glass is available in clear (-CG), frosted (-FG) or opal (-OG)
- See fixture pages for availability

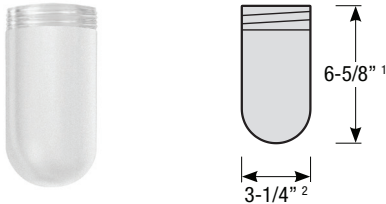

1. Heavy Metal and RDX glasses are 7-1/2" in height
2. Heavy Metal and RDX glasses are 4" in diameter

Glass Enclosure

- CG (Clear Glass Enclosure)
- FG (Frosted Glass Enclosure)
- OG (Opal Glass Enclosure)

Cast Guard with Glass Enclosure

- Cast guard can be specified in all standard and specialized finishes, and will match shade finish unless otherwise specified (Note: For galvanized shade finishes, cast guard is unfinished Raw Aluminum)
- Glass is available in clear (-CGG), frosted (-FGG) or opal (-OGG)
- See fixture pages for availability

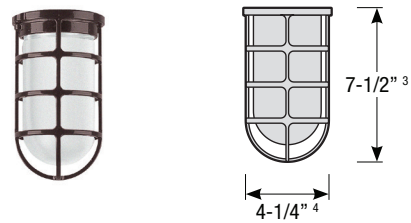

3. Heavy Metal and RDX cast guards are 8" in height
4. Heavy Metal and RDX cast guards are 5-1/2" in diameter

Cast Guard with Glass Enclosure

- CGG (Clear Glass w/ Cast Guard)
- FGG (Frosted Glass w/ Cast Guard)
- OGG (Opal Glass w/ Cast Guard)

Wire Cage with Glass Enclosure

- Wire cage can be specified in all standard and specialized finishes, and will match shade finish unless otherwise specified (Note: For galvanized shade finishes, wire cage is finished in Painted Natural Aluminum)
- Glass is available in clear (-CGWC), frosted (-FGWC) or opal (-OGWC)
- See fixture pages for availability

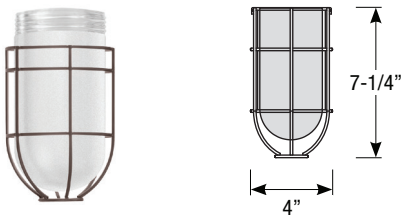

Wire Cage with Glass Enclosure

- CGWC (Clear Glass w/ Wire Cage)
- FGWC (Frosted Glass w/ Wire Cage)
- OGWC (Opal Glass w/ Wire Cage)

Wire Guard

- Wire cage can be specified in all standard and specialized finishes, and will match shade finish unless otherwise specified (Note: For galvanized shade finishes, wire guard is finished in Painted Natural Aluminum)
- See fixture pages for availability

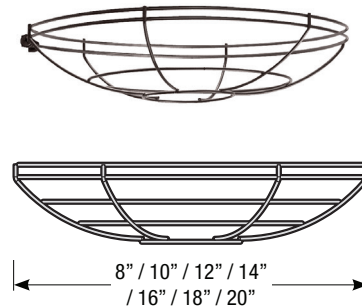

Wire Guard

- WG (Wire Guard)

RLM Structure

Luminaires can be mounted in a layout as opposed to individual fixtures.

Layouts can be customized to meet any criteria and most RLM shades are available. With 90° corners and 4-way octagon assemblies, RLM structure can be manipulated to create large rectangular designs or linear runs.

Ceiling structures can be suspended up to 8' with 1/2" or 3/4" IP conduit, or supported with 6' of aircraft cable. Luminaires can be suspended with 1/2" or 3/4" IP stems with lengths up to 8'.

For custom RLM structure quotes and layouts, please contact our facility. We will create a bill of materials to meet your needs along with a layout to reference.

90° Corner Layout Example

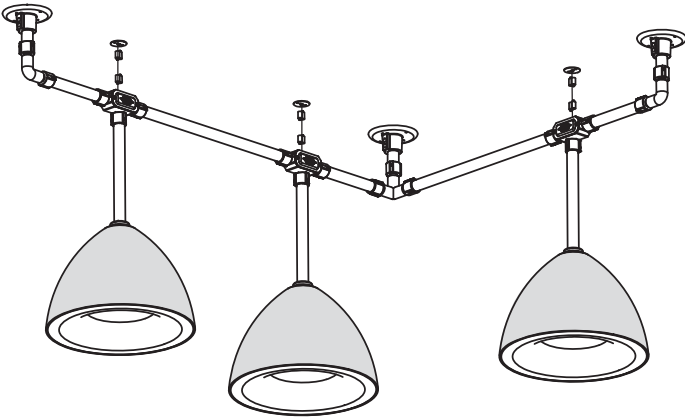

Linear Layout Example

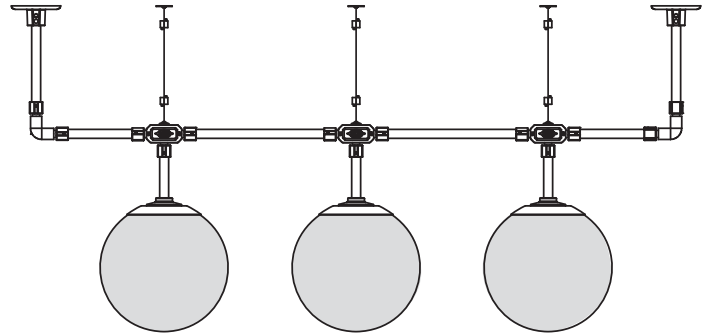

Rectangle Layout Example





Finishes

Standard Finishes

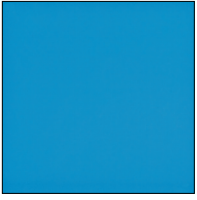

ABL Aegean Blue



BB Burnished Bronze



BK Gloss Black

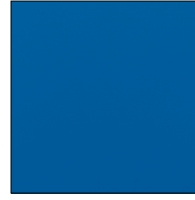

BLU Blue

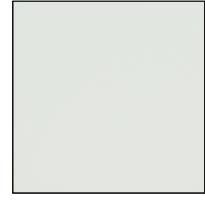

DVG Dove Gray

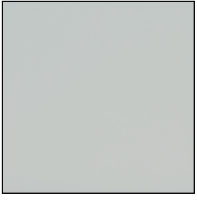

FLG Flannel Gray

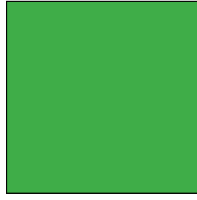

LG Lime Green

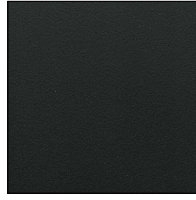

MB Matte Black

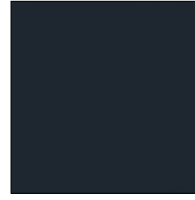

MBL Midnight Blue



PNA Painted Natural Aluminum



PNC Painted Natural Copper

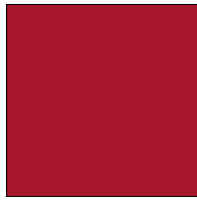

RD Red

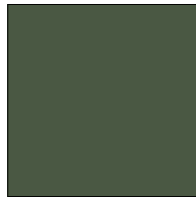

SGR Sage Green



SGW Semi Gloss White

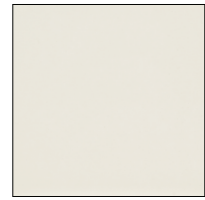

SND Sand

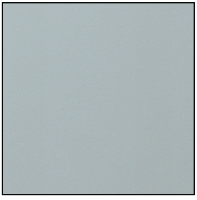

SS Satin Silver



TBZ Textured Bronze



TGP Textured Graphite

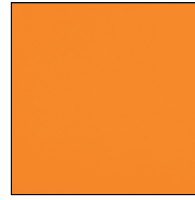

TNG Tangerine

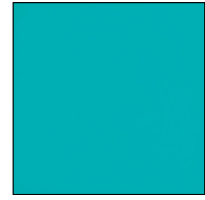

TTL Tahitian Teal

Specialty Finishes

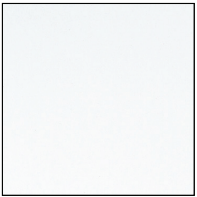

WT Gloss White



GA Galvanized

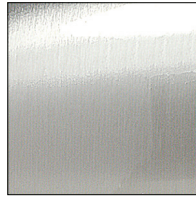

SA Satin Aluminum

Coastal Finish Option:

- The coastal finish is a coating available to protect finishes on fixtures installed in coastal environments. To specify, add "-C" to end of order number

Fixtures / Shades:

- Specialty finishes can be specified for all fixtures/shades, unless otherwise noted
- The insides of all shades are painted gloss white (WT), unless otherwise noted
- Fixtures/shades in galvanized (GA) finish are not painted white inside. Shades will be galvanized finish inside

Mounts:

- Arms, stems and wall mounts can be specified in all standard and specialty finishes
- Post mounts can be specified only in standard finishes
- Pendant and flush mount canopy's finish will match shade finish

Accessories:

- Cast guards, wire cages and wire guards can be specified in all standard and specialty finishes, and will match shade finish unless otherwise specified
- For galvanized (GA) fixtures/shades cast guards are unfinished raw aluminum; wire cages and wire guards are finished in painted natural aluminum

CATALOG #	PAGE #	CATALOG #	PAGE #	CATALOG #	PAGE #	CATALOG #	PAGE #	CATALOG #	PAGE #
A6	54	HS18	56	LL30	54	MD24	34	RHS16	48
A12	54	HS24	56	LLA23	15, 35	MD36	34	RI5	46
A18	54	HS36	56	LLA30	15, 35	NC14	38	RIC6	46
A24	54	HS48	56	LLB23	23, 41	NC16	38	RID13	46
A30	54	HSB12	23, 41	LLB30	23, 41	OG	57	RNCA12	36
AE14	4	HSB18	23, 41	LM18	54	OGG	57	RNCM12	36
AE16	4	HSB24	23, 41	LM24	54	OGWC	57	RNDA12	36
AR14	8	HSB36	23, 41	LM30	54	P1	55	RNDM12	36
AR16	8	HSB48	23, 41	LMA18	15, 35	P2	55	RNSA12	36
BC14	12	KNL	54	LMA24	15, 35	P8683-96	55	RNSA16	36
BC16	12	LB	30	LMA30	15, 35	P8683-120	55	RNSM12	36
BC18	12	LBD18	31	LMB18	23, 41	P8684-96	55	RNSM16	36
BL8	10	LBD24	31	LMB24	23, 41	P8684-120	55	RRS10	46
BL10	10	LBD30	31	LMB30	23, 41	PD14	40	RS16	50
BL12	10	LBM18	31	LSA23	54	PD18	40	RW16	42
CG	57	LBM24	31	LSA30	54	PM4946	55	RW18	42
CGG	57	LBM30	31	LSAA23	15, 35	PM8685	55	SA18	54
CGWC	57	LBMNP	31	LSAA30	15, 35	RA8	6	SA23	54
CL24	14	LBS6	31	LSAB23	23, 41	RA10	6	SAA18	15, 35
CL36	14	LBS12	31	LSAB30	23, 41	RA12	6	SAA23	15, 35
DM12	18	LBS24	31	MA18	54	RD10	16	SAB18	23, 41
DM14	18	LBS36	31	MA24	54	RD12	16	SAB23	23, 41
DM16	18	LBU18	31	MA30	54	RD14	16	SL23	54
FG	57	LBU24	31	MAA18	15, 35	RD16	16	SL30	54
FGG	57	LBU30	31	MAA24	15, 35	RDX18	44	SLA23	15, 35
FGWC	57	LC18	54	MAA30	15, 35	RDX20	44	SLA30	15, 35
FR12	22	LC24	54	MAB18	23, 41	RE8	20	SLB23	23, 41
FR16	22	LC30	54	MAB24	23, 41	RE10	20	SLB30	23, 41
GL12	24	LCA18	15, 35	MAB30	23, 41	RE12	20	TR12	52
GL14	24	LCA24	15, 35	MC8	32	RH12	26	TR14	52
GL16	24	LCA30	15, 35	MC10	32	RH14	26	TR16	52
GL18	24	LCB18	23, 41	MC12	32	RH16	26	TR18	52
HM18	28	LCB24	23, 41	MCA18	33	RH18	26	W1	55
HM20	28	LCB30	23, 41	MCA24	33	RH20	26	WG	57
HS12	56	LL23	54	MCA30	33	RHS14	48		

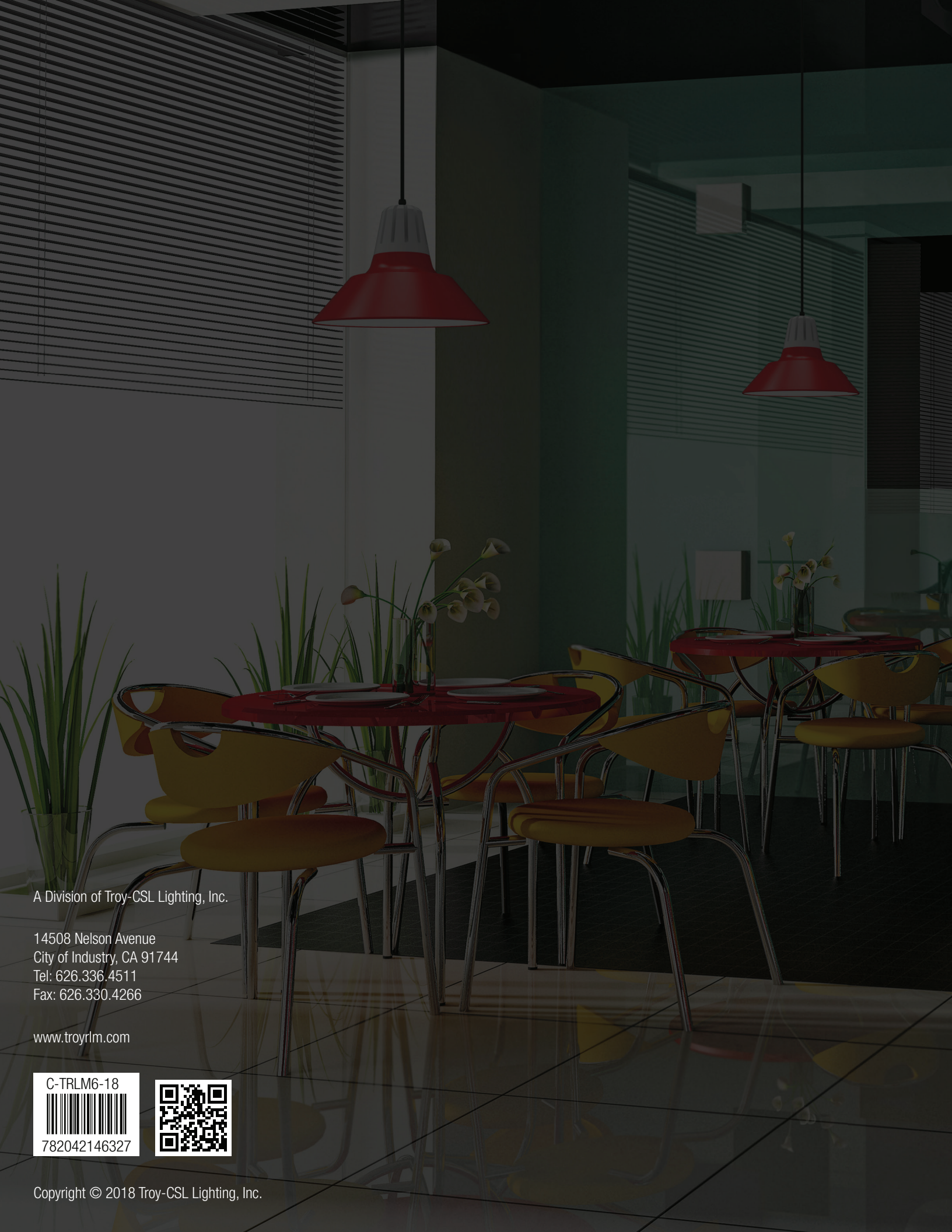

A Division of Troy-CSL Lighting, Inc.

14508 Nelson Avenue
City of Industry, CA 91744
Tel: 626.336.4511
Fax: 626.330.4266

www.troyrlm.com

C-TRLM6-18



782042146327

