



SAVOY HOUSE



ESSENTIALS

JANUARY 2023



SAVOY HOUSE ESSENTIALS

The Savoy House Essentials collection was designed with modern American home décor style in mind.

Blurring the boundaries of classic and traditional, modern and contemporary, Essentials fixtures effortlessly mix and match allowing you to create a refined style. Each piece is crafted and thoughtfully chosen to work well on its own or together for a complementary companion look.

Offered in up to five finishes, including our most popular matte black, Essentials is perfect for today's open-concept home designs. Designed with the same high quality and attention to detail that you have come to expect from Savoy House, customers can choose with confidence when they choose to purchase from the Savoy House Essentials collection.



CONTENTS

ALPHABETICAL LISTING BY FAMILY:

Akron..... 172	Franklin.....186	Penrose..... 134, 206
Alden..... 142	Fremont..... 218	Pike..... 232
Ballas..... 254	Galea..... 138	Polson..... 213
Bally..... 186	Garnet..... 248	Powell..... 88, 228
Benson..... 130, 205	Genry..... 10	Reid..... 188
Berg..... 144, 207	Glenn..... 238	Renzo..... 4
Brody..... 82	Gordon..... 258	Rhodes..... 214
Calhoun..... 100, 206, 252	Hampton..... 246	Rohe..... 8
Cameron..... 90, 224, 286	Haynes..... 34	Sacramento..... 256
Capra..... 282	Herndon..... 110, 185, 246, 296	Salerno..... 72
Carlton..... 94, 181	Jasmine..... 74	Seagram..... 140
Carson..... 247, 262	Jefferson..... 216	Seville..... 62
Chantilly..... 250	Joffree..... 212	Stirling..... 169
Chival..... 185	Kaden..... 284	Stockton..... 192
Clifton..... 233	Kane..... 297	Torino..... 78
Colton..... 108, 246, 294	Kent..... 132, 204	Townsend..... 112
Como..... 210	Kenyon..... 234	Vale..... 280
Crawford..... 96, 237	Lakewood..... 50, 272	Ventari..... 16
Cristofer..... 38	Lyrique..... 68, 194	Vintage..... 185
Crosby..... 46, 266	Mansfield..... 164	Washburn..... 225
Dakota..... 244	Marco..... 190	Watkins..... 196
Dawson..... 235	Marshall..... 278	Waverly..... 239
Denton..... 126	Mason..... 260	Westbourne..... 169
Destin..... 226	Melrose..... 208, 246, 288	Whitney..... 292
Devon..... 227	Middleton..... 54	Willis..... 146
Diplomat..... 128	Monroe..... 220	Willmar..... 230
Drake..... 245, 247	Morland..... 242	Winfield..... 22
Edgewood..... 86	Newport..... 80	Wright..... 42, 181, 264
Elise..... 247, 297	Octave..... 104, 247, 268	Yates..... 296
Fallon..... 30	Owen..... 243	York..... 240
Falster..... 26	Palladian..... 124	
Foster..... 236	Pendleton..... 207	

CONTENTS



Collections 4



Ceiling.....188



Wall Lighting.....210



Pour Le Bain / Vanity / Glass 248

Finish Guide / Index 298



Includes 12" & 6" extensions - additional stems available - 7-EXT



Dual Mount Hanging System

- | | | | |
|------------------------------------------------------------------------------------------------------------------------------------------------------------------------------------------------|------------------------------------------------------------------------------------------------------------------------------------------------------------------------------------------------|------------------------------------------------------------------------------------------------------------------------------------------------------------------------------------------------|------------------------------------------------------------------------------------------------------------------------------------------------------------------------------------------------|
| <p>A. 7-9044-3-89
 3-Light Pendant
 Matte Black Finish
 16"W x 12"H
 Adj H 12" - 66"
 3E 60W
 Clear Crystal</p> | <p>B. 7-9046-4-89
 4-Light Pendant
 Matte Black Finish
 22"W x 12"H
 Adj H 12" - 66"
 4E 60W
 Clear Crystal</p> | <p>C. 7-9046-4-322
 4-Light Pendant
 Warm Brass Finish
 22"W x 12"H
 Adj H 12" - 66"
 4E 60W
 Clear Crystal</p> | <p>D. 7-9044-3-322
 3-Light Pendant
 Warm Brass Finish
 16"W x 12"H
 Adj H 12" - 66"
 3E 60W
 Clear Crystal</p> |
|------------------------------------------------------------------------------------------------------------------------------------------------------------------------------------------------|------------------------------------------------------------------------------------------------------------------------------------------------------------------------------------------------|------------------------------------------------------------------------------------------------------------------------------------------------------------------------------------------------|------------------------------------------------------------------------------------------------------------------------------------------------------------------------------------------------|



Includes 12" & 6" extensions - additional stems available - **7-EXT**



Dual Mount Hanging System



A.

B.

A. 7-9048-6-89
 6-Light Pendant
 Matte Black Finish
 28"W x 12"H
 Adj H 12" - 66"
 6E 60W
 Clear Crystal

B. 7-9048-6-322
 6-Light Pendant
 Warm Brass Finish
 28"W x 12"H
 Adj H 12" - 66"
 6E 60W
 Clear Crystal

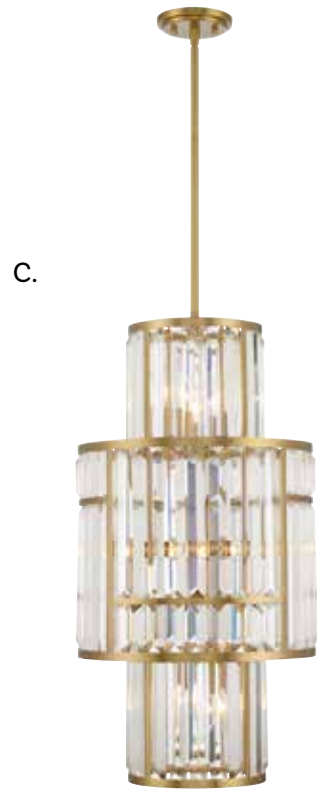

Includes 12" & 6" extensions - additional stems available - 7-EXTLG

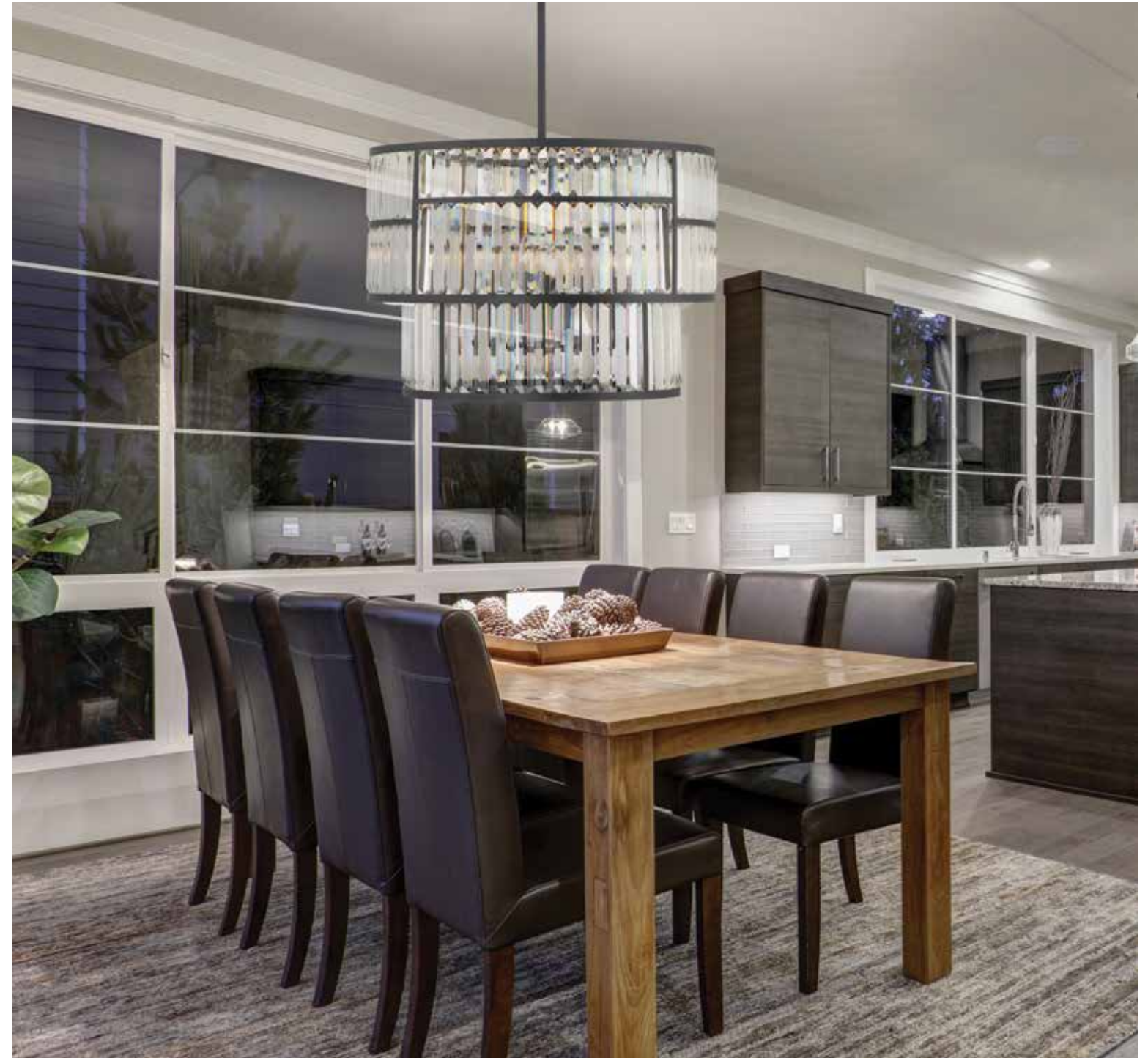

Dual Mount Hanging System

- | | | | |
|------------------------------------------------------------------------------------------------------------------------------------------------------|----------------------------------------------------------------------------------------------------------------------------------------------|----------------------------------------------------------------------------------------------------------------------------------------------|------------------------------------------------------------------------------------------------------------------------------------------------------|
| <p>A. 7-2224-5-89
5-Light Pendant
Matte Black Finish
26"W x 19-1/4"H
Adj H 19-1/4" - 73-1/4"
5C 60W
Clear Crystal</p> | <p>B. 3-2226-8-89
8-Light Pendant
Matte Black Finish
15-3/4"W x 31"H
Adj H 31" - 85"
8C 60W
Clear Crystal</p> | <p>C. 3-2226-8-322
8-Light Pendant
Warm Brass Finish
15-3/4"W x 31"H
Adj H 31" - 85"
8C 60W
Clear Crystal</p> | <p>D. 7-2224-5-322
5-Light Pendant
Warm Brass Finish
26"W x 19-1/4"H
Adj H 19-1/4" - 73-1/4"
5C 60W
Clear Crystal</p> |
|------------------------------------------------------------------------------------------------------------------------------------------------------|----------------------------------------------------------------------------------------------------------------------------------------------|----------------------------------------------------------------------------------------------------------------------------------------------|------------------------------------------------------------------------------------------------------------------------------------------------------|



Includes 120" chain & wire



A.



B.

A. 1-8200-5-109
5-Light Pendant
Polished Nickel Finish
26"W x 25-1/2"H
5E 60W
Clear Water Piastra Glass

B. 1-8200-5-322
5-Light Pendant
Warm Brass Finish
26"W x 25-1/2"H
5E 60W
Clear Water Piastra Glass

C. 1-8200-5-89
5-Light Pendant
Matte Black Finish
26"W x 25-1/2"H
5E 60W
Clear Water Piastra Glass



C.



Includes 120" chain & wire



A. 1-8203-3-109
 3-Light Linear Chandelier
 Polished Nickel Finish
 41"L x 13"W x 31-1/2"H
 3E 60W
 Clear Water Piastra Glass

B. 1-8203-3-322
 3-Light Linear Chandelier
 Warm Brass Finish
 41"L x 13"W x 31-1/2"H
 3E 60W
 Clear Water Piastra Glass

C. 1-8203-3-89
 3-Light Linear Chandelier
 Matte Black Finish
 41"L x 13"W x 31-1/2"H
 3E 60W
 Clear Water Piastra Glass



FAN NUMBER	27-FD-8201-109	27-FD-8201-322	27-FD-8201-89
MOTOR FINISH	Polished Nickel	Warm Brass	Matte Black
BLADE FINISH	Silver	Gold	Black
FAN LIGHT	Integrated	Integrated	Integrated
DOWNROD FINISH	109	322	FB

- Motor Size 104 x 117
- 14" Blade Span
- 27"W x 27-1/2"H
- 13° Blade Pitch
- 3-Speed Reversible Motor
- Additional Downrod Lengths Sold Separately
- 5E 8W LED Dimmable Bulbs (1800 Lumens per bulb, 3000K, 90+ CRI)
- Handheld Remote with E Receiver Included (RMT-AC-UNIVERSAL)
- Not Hugger Kit Adaptable
- Fan & Blades are ETL Damp Location

ENERGY USE AT HIGH SPEED

Airflow Use 1,395 Cu Ft/Min	Electricity Use 35W Excludes Lights	Airflow Efficiency 39.86 Cu Ft/Min/W
------------------------------------------	--------------------------------------------------	---------------------------------------------------

Compare: 49" to 60" ceiling fans have airflow efficiencies ranging from approximately 51 to 176 cu. ft. per min per watt at high speed.





Includes 12" & 6" extensions - additional stems available - 7-EXT



Dual Mount Hanging System

- | | | | |
|--------------------------------------------------------------------------------------------------------------------------------------------|----------------------------------------------------------------------------------------------------------------------------------------|----------------------------------------------------------------------------------------------------------------------------------------|--------------------------------------------------------------------------------------------------------------------------------------------|
| <p>A. 7-8855-1-322
1-Light Pendant
Warm Brass Finish
10-1/4"W x 11"H
Adj H 11" - 65"
1E 60W
Clear Glass</p> | <p>B. 7-8857-5-322
5-Light Pendant
Warm Brass Finish
24"W x 25"H
Adj H 25" - 79"
5E 60W
Clear Glass</p> | <p>C. 7-8857-5-89
5-Light Pendant
Matte Black Finish
24"W x 25"H
Adj H 25" - 79"
5E 60W
Clear Glass</p> | <p>D. 7-8855-1-89
1-Light Pendant
Matte Black Finish
10-1/4"W x 11"H
Adj H 11" - 65"
1E 60W
Clear Glass</p> |
|--------------------------------------------------------------------------------------------------------------------------------------------|----------------------------------------------------------------------------------------------------------------------------------------|----------------------------------------------------------------------------------------------------------------------------------------|--------------------------------------------------------------------------------------------------------------------------------------------|



Includes 12" & 6" extensions - additional stems available - 7-EXT



Dual Mount Hanging System



A. 7-8859-8-322
 8-Light Pendant
 Warm Brass Finish
 25"W x 41"H
 Adj H 41" - 95"
 8E 60W
 Clear Glass

B. 7-8859-8-89
 8-Light Pendant
 Matte Black Finish
 25"W x 41"H
 Adj H 41" - 95"
 8E 60W
 Clear Glass



FAN NUMBER	24-FD-8853-322	24-FD-8853-89
MOTOR FINISH	Warm Brass	Matte Black
BLADE FINISH	Gold	Black
FAN LIGHT	Integrated	Integrated
DOWNROD FINISH	322	FB

- Motor Size 80 x 70
- 12" Blade Span
- 24"W x 30"H
- 16° Blade Pitch
- 3-Speed Reversible Motor
- Additional Downrod Lengths Sold Separately
- 5C 6W LED Dimmable Bulbs (500 Lumens per bulb, 3000K, 90+ CRI)
- Handheld Remote with C Receiver Included (RMT-AC-UNIVERSAL)
- Not Hugger Kit Adaptable
- Fan & Blades are ETL Dry Location



ENERGY USE AT HIGH SPEED

Airflow Use 1,222 Cu Ft/Min	Electricity Use 28.1W Excludes Lights	Airflow Efficiency 43.48 Cu Ft/Min/W
-----------------------------------	---------------------------------------------	--------------------------------------------

Compare: 49" to 60" ceiling fans have airflow efficiencies ranging from approximately 51 to 176 cu. ft. per min per watt at high speed.





*Includes 9-1/2" extensions - additional stems available - **7-EXT**
 Includes 12" & 6" extensions - additional stems available - **7-EXT



A. 9-9771-2-89
 2-Light Sconce
 Matte Black Finish
 4-1/2"W x 15-1/2"H x 5-1/2"E
 2C 60W
 Clear Glass

B. 7-9770-1-89
 1-Light Mini-Pendant
 Matte Black Finish
 5-1/8"W x 15-3/4"H
 Adj H 15-3/4" - 47-1/4"
 1E 60W
 90° Swivel
 Clear Glass

C. 1-9772-10-89
 10-Light Chandelier
 Matte Black Finish
 25"W x 18-1/2"H
 Adj H 18-1/2" - 75-1/2"
 10C 60W
 30° Swivel
 Clear Glass

D. 1-9773-12-89
 12-Light Linear Chandelier
 Matte Black Finish
 38"L x 14"W x 17-1/4"H
 Adj H 17-1/4" - 74-1/4"
 12C 60W
 30° Swivel
 Clear Glass



A. 9-9771-2-322

2-Light Sconce
Warm Brass Finish
4-1/2"W x 15-1/2"H x 5-1/2"E
2C 60W
Clear Glass

B. 7-9770-1-322

1-Light Mini-Pendant
Warm Brass Finish
5-1/8"W x 15-3/4"H
Adj H 15-3/4" - 47-1/4"
1E 60W
90° Swivel
Clear Glass

C. 1-9772-10-322

10-Light Chandelier
Warm Brass Finish
25"W x 18-1/2"H
Adj H 18-1/2" - 75-1/2"
10C 60W
30° Swivel
Clear Glass

D. 1-9773-12-322

12-Light Linear Chandelier
Warm Brass Finish
38"L x 14"W x 17-1/4"H
Adj H 17-1/4" - 74-1/4"
12C 60W
30° Swivel
Clear Glass



*Includes 9-1/2" extensions - additional stems available - **7-EXT**
Includes 12" & 6" extensions - additional stems available - **7-EXT



LED



Dual Mount Hanging System

A. 1-5409-5-322
 5-Light Chandelier
 Warm Brass Finish
 26"W x 5-1/2"H
 Adj H 5-1/2" - 59-1/2"
 5G9 3W LED
 810 Lumens, 3000K, 90+ CRI
 Clear Seeded Glass
G9 Bulbs Included

B. 9-5405-1-322
 1-Light Sconce
 Warm Brass Finish
 5-3/4"W x 7"H x 8-1/2"E
 1G9 3W LED
 160 Lumens, 3000K, 90+ CRI
 Clear Seeded Glass
G9 Bulb Included

C. 1-5407-5-322
 5-Light Linear Chandelier
 Warm Brass Finish
 42"L x 5-3/4"W x 9-1/2"H
 Adj H 9-1/2" - 63-1/2"
 5G9 3W LED
 810 Lumens, 3000K, 90+ CRI
 Clear Seeded Glass
G9 Bulbs Included

*Includes 12" & 6" extensions - additional stems available - **7-EXT**

FALSTER



Dual Mount Hanging System

A. 9-5405-1-89
 1-Light Sconce
 Matte Black Finish
 5-3/4"W x 7"H x 8-1/2"E
 1G9 3W LED
 160 Lumens, 3000K, 90+ CRI
 Clear Seeded Glass
G9 Bulb Included

B. 1-5409-5-89
 5-Light Chandelier
 Matte Black Finish
 26"W x 5-1/2"H
 Adj H 5-1/2" - 59-1/2"
 5G9 3W LED
 810 Lumens, 3000K, 90+ CRI
 Clear Seeded Glass
G9 Bulbs Included

C. 1-5407-5-89
 5-Light Linear Chandelier
 Matte Black Finish
 42"L x 5-3/4"W x 9-1/2"H
 Adj H 9-1/2" - 63-1/2"
 5G9 3W LED
 810 Lumens, 3000K, 90+ CRI
 Clear Seeded Glass
G9 Bulbs Included

FALSTER



A.

LED



*B.



*C.

*Includes 12" & 6" extensions - additional stems available - 7-EXT



*Includes 12" & 6" extensions - additional stems available - 7-EXT

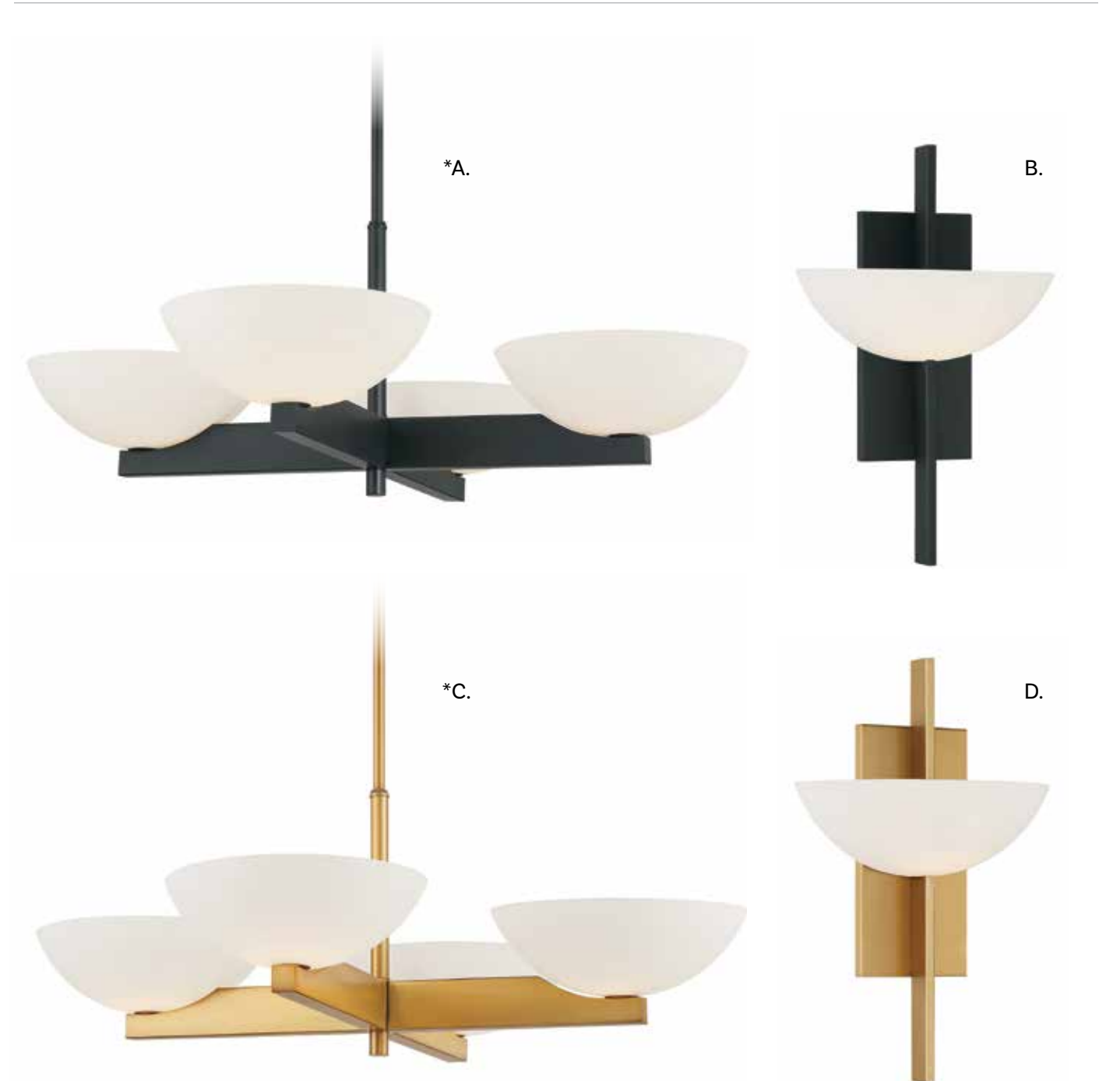

Dual Mount Hanging System

- | | | | |
|------------------------------------------------------------------------------------------------------------------------------------------------------------------------------|---------------------------------------------------------------------------------------------------------------------------------------------------------------|------------------------------------------------------------------------------------------------------------------------------------------------------------------------------|----------------------------------------------------------------------------------------------------------------------------------------------------------------|
| <p>A. 1-1613-4-89
4-Light Chandelier
Matte Black Finish
30"W x 11"H
Adj H 11" - 65"
4G9 60W
White Opal Glass
G9 Bulbs Included</p> | <p>B. 9-1615-1-89
1-Light Sconce
Matte Black Finish
10"W x 15"H x 5-1/2"E
1G9 60W
White Opal Glass
G9 Bulb Included</p> | <p>C. 1-1613-4-322
4-Light Chandelier
Warm Brass Finish
30"W x 11"H
Adj H 11" - 65"
4G9 60W
White Opal Glass
G9 Bulbs Included</p> | <p>D. 9-1615-1-322
1-Light Sconce
Warm Brass Finish
10"W x 15"H x 5-1/2"E
1G9 60W
White Opal Glass
G9 Bulbs Included</p> |
|------------------------------------------------------------------------------------------------------------------------------------------------------------------------------|---------------------------------------------------------------------------------------------------------------------------------------------------------------|------------------------------------------------------------------------------------------------------------------------------------------------------------------------------|----------------------------------------------------------------------------------------------------------------------------------------------------------------|



Includes 12" & 6" extensions - additional stems available - **7-EXT**



A. 1-1614-3-322
 3-Light Linear Chandelier
 Warm Brass Finish
 45"L x 10"W x 4-1/2"H
 Adj H 4-1/2" - 58-1/2"
 3G9 60W
 White Opal Glass
G9 Bulbs Included

B. 1-1614-3-89
 3-Light Linear Chandelier
 Matte Black Finish
 45"L x 10"W x 4-1/2"H
 Adj H 4-1/2" - 58-1/2"
 3G9 60W
 White Opal Glass
G9 Bulbs Included

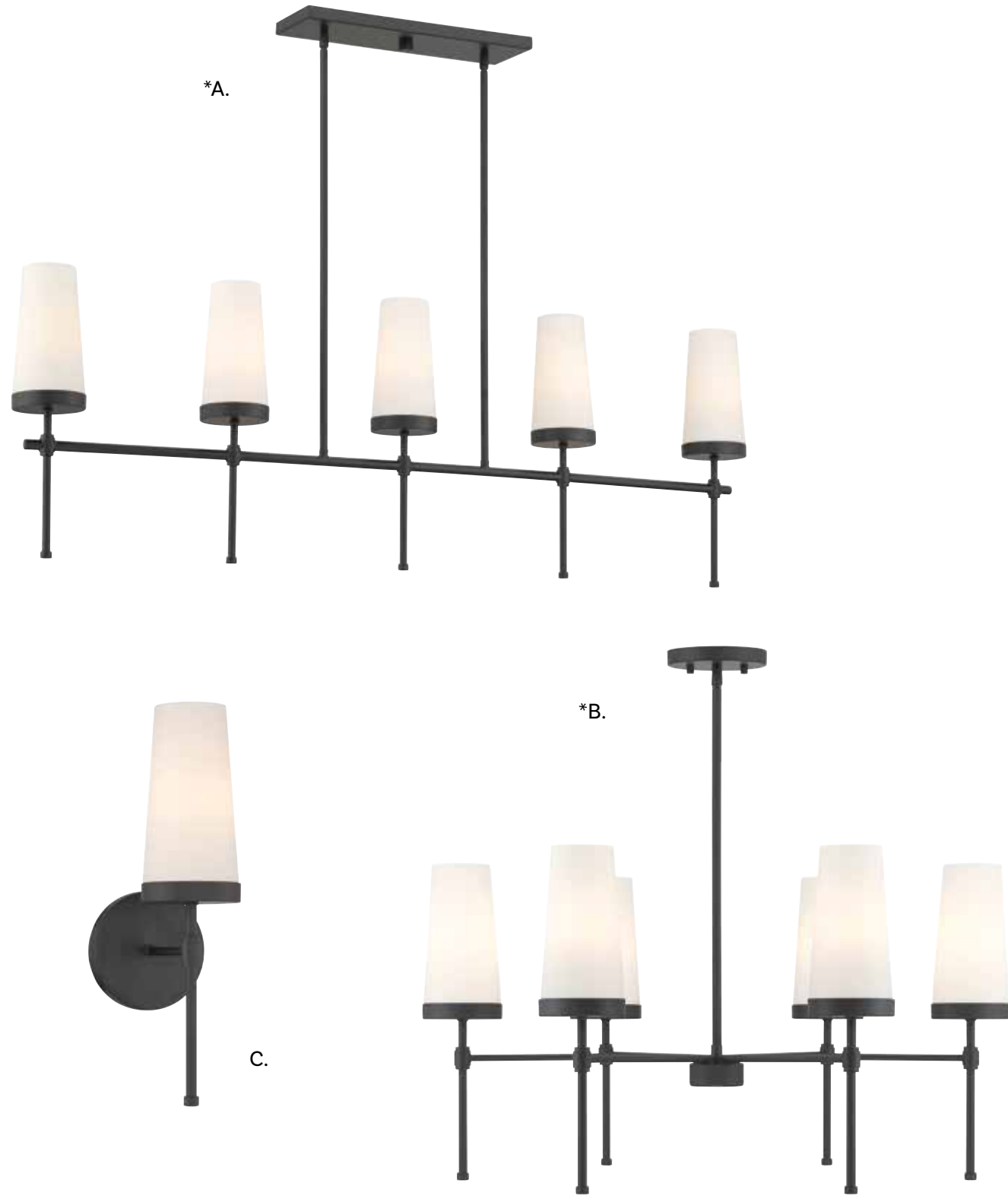

*Includes 12" & 6" extensions - additional stems available - 7-EXT



Dual Mount Hanging System

A. 1-2803-5-89
 5-Light Linear Chandelier
 Matte Black Finish
 48"L x 4"W x 16"H
 Adj H 16" - 70"
 5C 60W
 White Opal Glass

B. 1-2802-6-89
 6-Light Chandelier
 Matte Black Finish
 30"W x 16"H
 Adj H 16" - 70"
 6C 60W
 White Opal Glass

C. 9-2801-1-89
 1-Light Sconce
 Matte Black Finish
 5"W x 16"H x 7"E
 1C 60W
 White Opal Glass



Dual Mount Hanging System

A. 1-2803-5-322
 5-Light Linear Chandelier
 Warm Brass Finish
 48" L x 4" W x 16" H
 Adj H 16" - 70"
 5C 60W
 White Opal Glass

B. 1-2802-6-322
 6-Light Chandelier
 Warm Brass Finish
 30" W x 16" H
 Adj H 16" - 70"
 6C 60W
 White Opal Glass

C. 9-2801-1-322
 1-Light Sconce
 Warm Brass Finish
 5" W x 16" H x 7" E
 1C 60W
 White Opal Glass



*Includes 12" & 6" extensions - additional stems available - 7-EXT



Includes 12" & 6" extensions - additional stems available - 7-EXT



Dual Mount Hanging System



A. 1-1624-8-89
8-Light Linear Chandelier
Matte Black Finish
36"L x 21"W x 8"H
Adj H 8" - 62"
8C 60W

B. 1-1624-8-322
8-Light Linear Chandelier
Warm Brass Finish
36"L x 21"W x 8"H
Adj H 8" - 62"
8C 60W

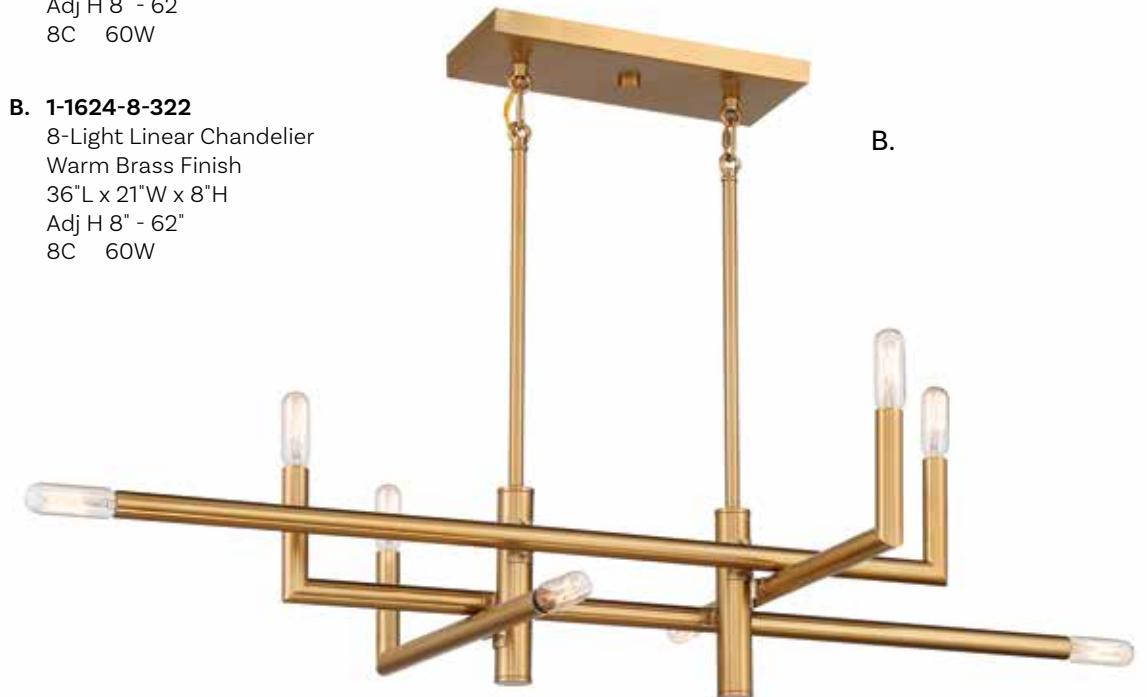

B.



Includes 12" & 6" extensions - additional stems available - 7-EXT



Dual Mount Hanging System

A.

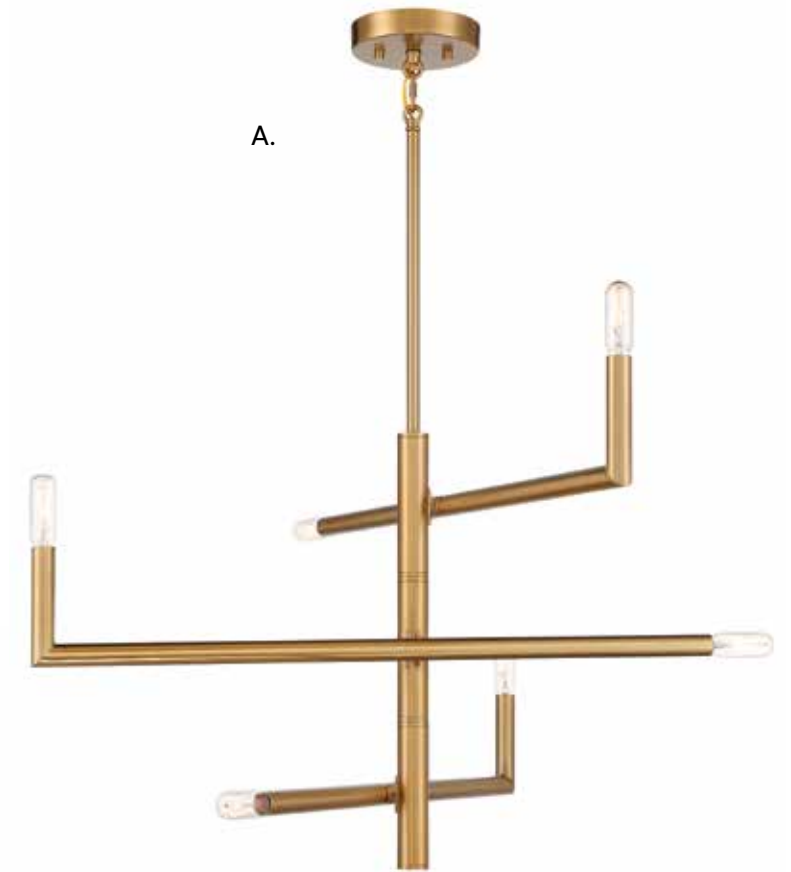

B.

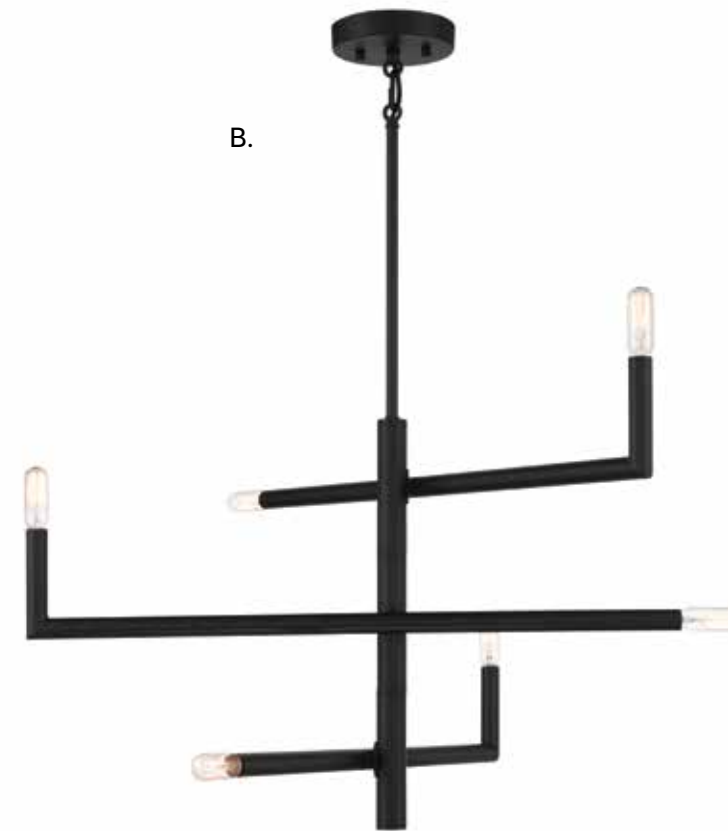

A. 1-1623-6-322
 6-Light Chandelier
 Warm Brass Finish
 30"W x 17"H
 Adj H 17" - 71"
 6C 60W

B. 1-1623-6-89
 6-Light Chandelier
 Matte Black Finish
 30"W x 17"H
 Adj H 17" - 71"
 6C 60W



*Includes 12" & 6" extensions - additional stems available - **7-EXTLG**

Includes 12" & 6" extensions - additional stems available - **7-EXT

*A.



A. 1-3074-8-89
 8-Light Chandelier
 Matte Black Finish
 40"W x 10"H
 Adj H 10" - 64"
 8E 60W
 Clear Glass

**B.



B. 1-3073-5-89
 5-Light Chandelier
 Matte Black Finish
 28"W x 10"H
 Adj H 10" - 64"
 5E 60W
 Clear Glass



Dual Mount Hanging System



Pendant, Page 179



Bath, Page 263



Sconce, Page 262



*A.



Dual Mount Hanging System

A. 1-3074-8-322
8-Light Chandelier
Warm Brass Finish
40"W x 10"H
Adj H 10" - 64"
8E 60W
Clear Glass

B. 1-3073-5-322
5-Light Chandelier
Warm Brass Finish
28"W x 10"H
Adj H 10" - 64"
5E 60W
Clear Glass



**B.

*Includes 12" & 6" extensions - additional stems available - **7-EXTLG**

Includes 12" & 6" extensions - additional stems available - **7-EXT



Sconce, Page 261

Bath, Page 262

Pendant, Page 178



*C.



Dual Mount Hanging System

C. 1-3074-8-11
8-Light Chandelier
Polished Chrome Finish
40"W x 10"H
Adj H 10" - 64"
8E 60W
Clear Glass

D. 1-3073-5-11
5-Light Chandelier
Polished Chrome Finish
28"W x 10"H
Adj H 10" - 64"
5E 60W
Clear Glass



**D.



Pendant, Page 178

Bath, Page 262

Sconce, Page 261



A.



Dual Mount Hanging System

A. 1-1862-8-322
 8-Light Linear Chandelier
 Warm Brass Finish
 42"L x 16"W x 9-3/4"H
 Adj H 9-3/4" - 63-3/4"
 8C 60W
 Clear Glass

B. 1-1862-8-89
 8-Light Linear Chandelier
 Matte Black Finish
 42"L x 16"W x 9-3/4"H
 Adj H 9-3/4" - 63-3/4"
 8C 60W
 Clear Glass



B.



Includes 12" & 6" extensions - additional stems available - 7-EXT

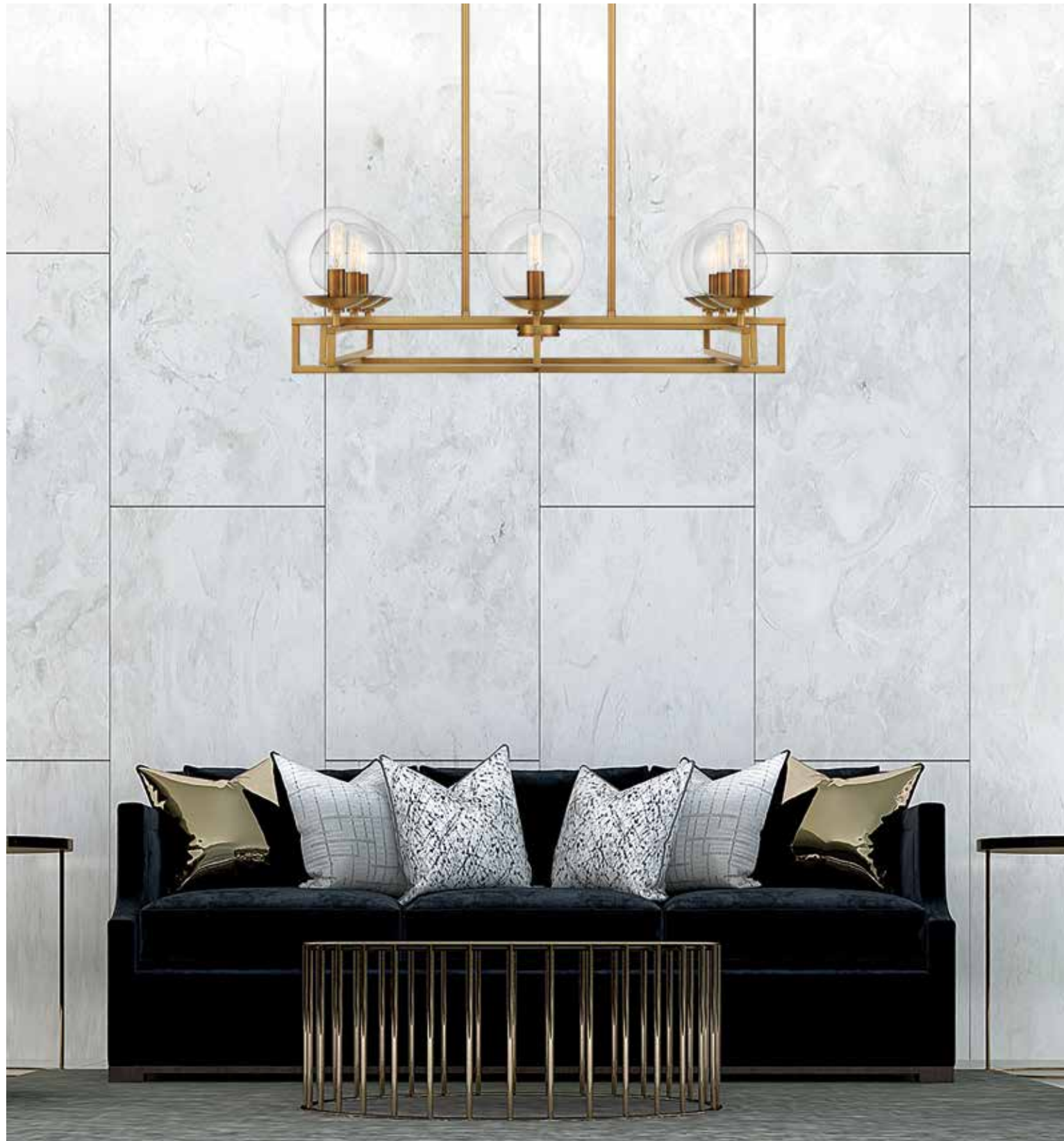

Includes 12" & 6" extensions - additional stems available - 7-EXT



Dual Mount Hanging System

A.



B.

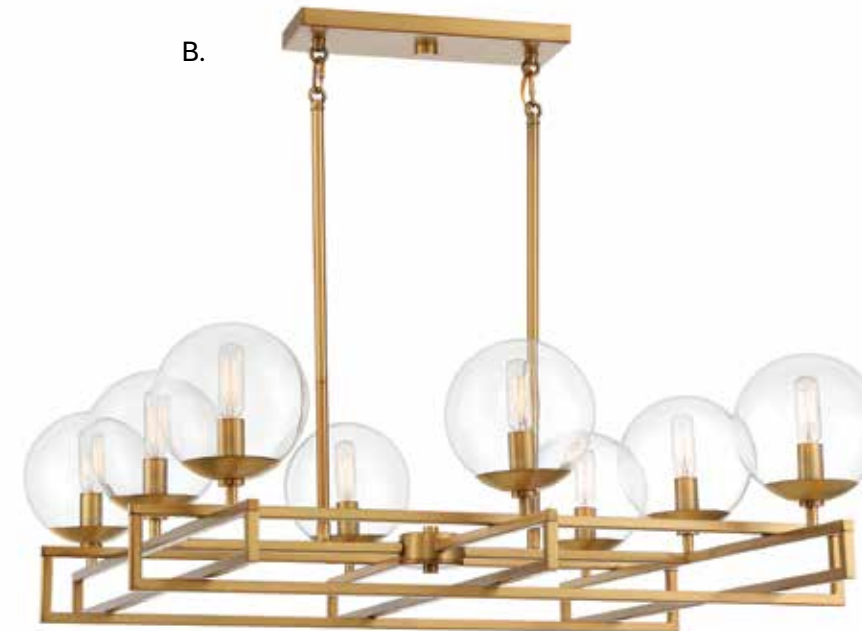

A. 1-1861-8-89
 8-Light Chandelier
 Matte Black Finish
 30"L x 30"W x 9-3/4"H
 Adj H 9-3/4" - 63-3/4"
 8C 60W
 Clear Glass

B. 1-1861-8-322
 8-Light Chandelier
 Warm Brass Finish
 30"L x 30"W x 9-3/4"H
 Adj H 9-3/4" - 63-3/4"
 8C 60W
 Clear Glass



Bath, Page 264



Dual Mount Hanging System

A. 7-1831-1-322
 1-Light Mini-Pendant
 Warm Brass Finish
 8"W x 22"H
 Adj H 22" - 50-1/2"
 1E 60W
 Clear Glass

B. 1-1832-5-322
 5-Light Chandelier
 Warm Brass Finish
 28"W x 20"H
 Adj H 20" - 74"
 5E 60W
 Clear Glass

C. 1-1833-6-322
 6-Light Linear Chandelier
 Warm Brass Finish
 40"L x 17-1/2"W x 17"H
 Adj H 17" - 71"
 6E 60W
 Clear Glass



*Includes 9-1/2" extensions - additional stems available - **7-EXT**
 Includes 12" & 6" extensions - additional stems available - **7-EXT



Pendants, Page 174



Dual Mount Hanging System

A. 7-1831-1-89
 1-Light Mini-Pendant
 Matte Black Finish
 8"W x 22"H
 Adj H 22" - 50-1/2"
 1E 60W
 Clear Glass

B. 1-1832-5-89
 5-Light Chandelier
 Matte Black Finish
 28"W x 20"H
 Adj H 20" - 74"
 5E 60W
 Clear Glass

C. 1-1833-6-89
 6-Light Linear Chandelier
 Matte Black Finish
 40"L x 17-1/2"W x 17"H
 Adj H 17" - 71"
 6E 60W
 Clear Glass



*Includes 9-1/2" extensions - additional stems available - **7-EXT**
 Includes 12" & 6" extensions - additional stems available - **7-EXT



Pendants, Page 174

MIDDLETON



Includes 120" chain & wire

MIDDLETON



A.

B.

A. 1-307-6-89
6-Light Chandelier
Matte Black Finish
25"W x 23"H
6C 60W
Metal Candle Covers

B. 1-307-6-322
6-Light Chandelier
Warm Brass Finish
25"W x 23"H
6C 60W
Metal Candle Covers

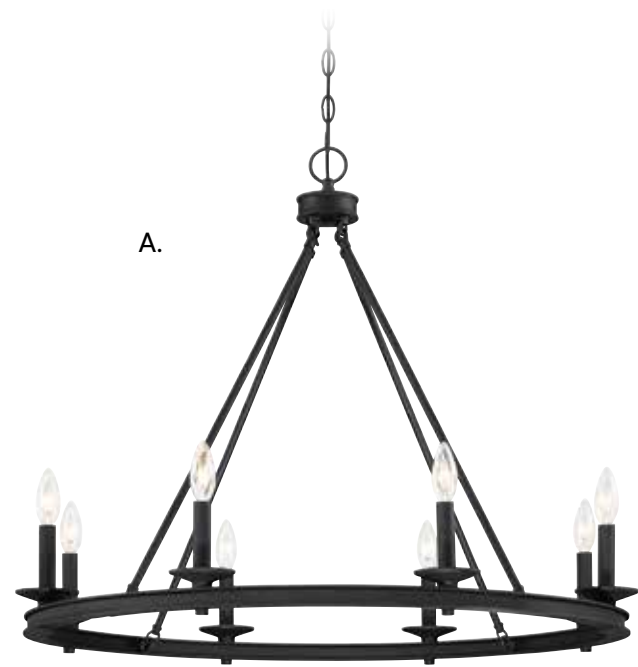

A.

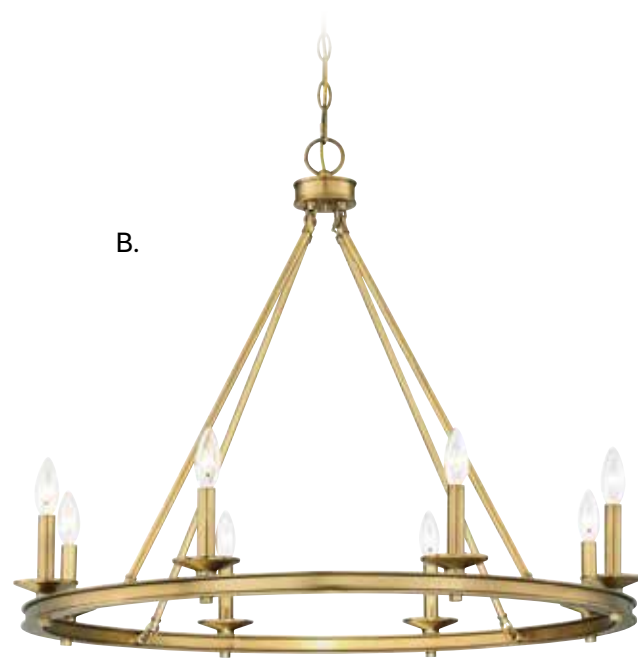

B.

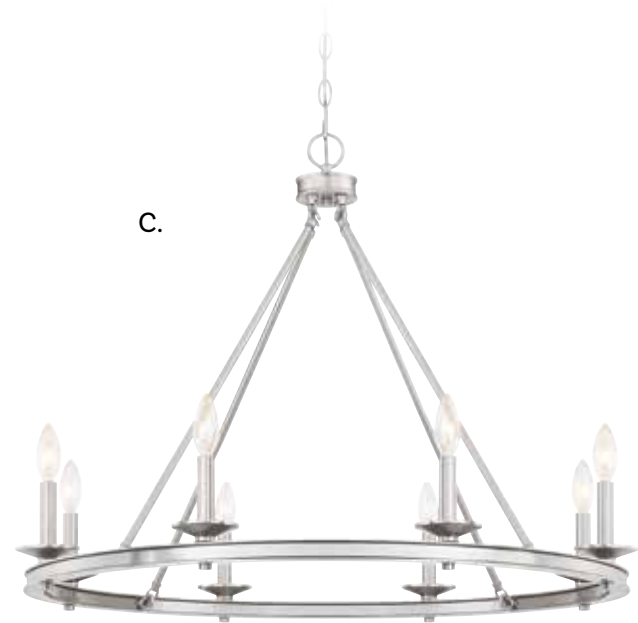

C.

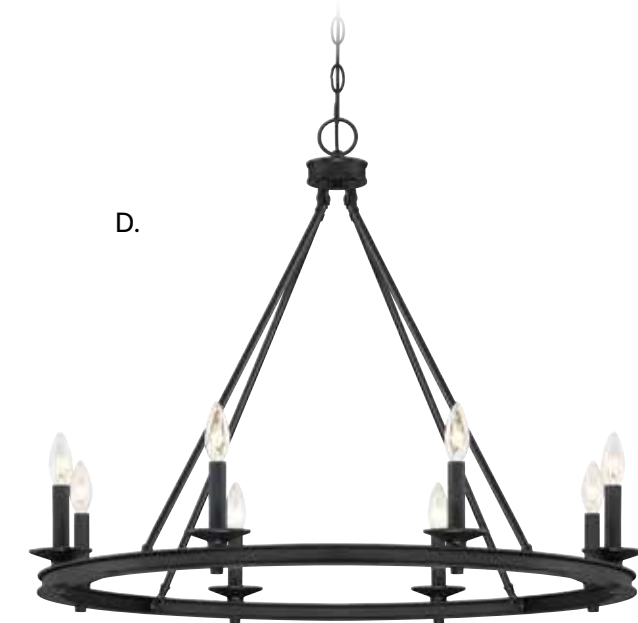

D.

A. 1-308-8-89
8-Light Chandelier
Matte Black Finish
33"W x 25"H
8C 60W
Metal Candle Covers

B. 1-308-8-322
8-Light Chandelier
Warm Brass Finish
33"W x 25"H
8C 60W
Metal Candle Covers

C. 1-308-8-SN
8-Light Chandelier
Satin Nickel Finish
33"W x 25"H
8C 60W
Metal Candle Covers

D. 1-308-8-44
8-Light Chandelier
Classic Bronze Finish
33"W x 25"H
8C 60W
Metal Candle Covers



Includes 120" chain & wire



Includes 120" chain & wire

A. 1-310-10-322
10-Light Chandelier
Warm Brass Finish
45"W x 32-1/4"H
10C 60W
Metal Candle Covers

B. 1-310-10-89
10-Light Chandelier
Matte Black Finish
45"W x 32-1/4"H
10C 60W
Metal Candle Covers

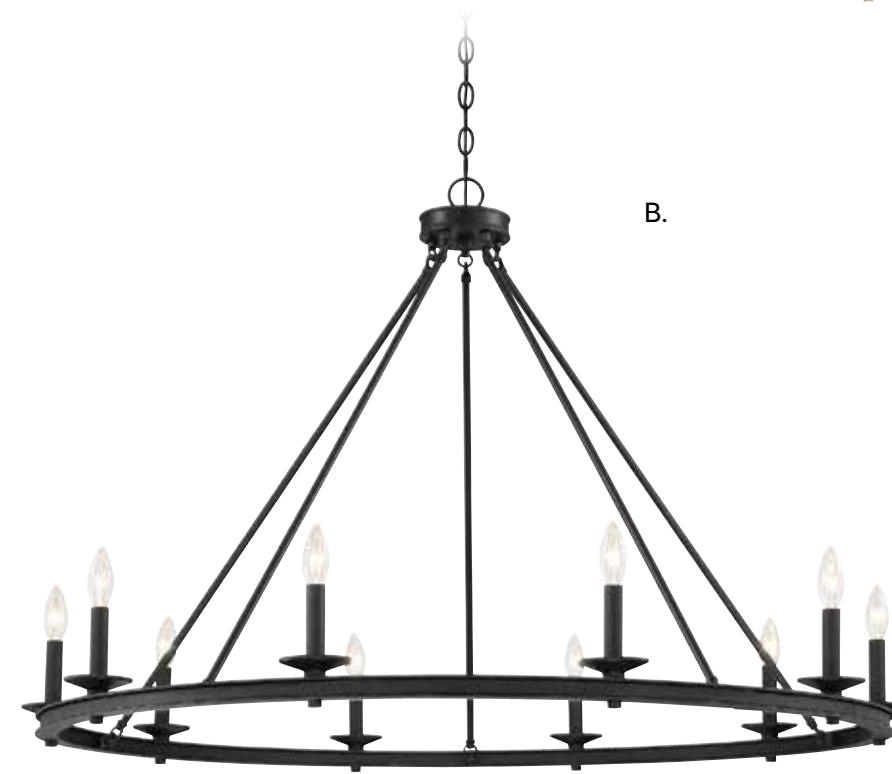
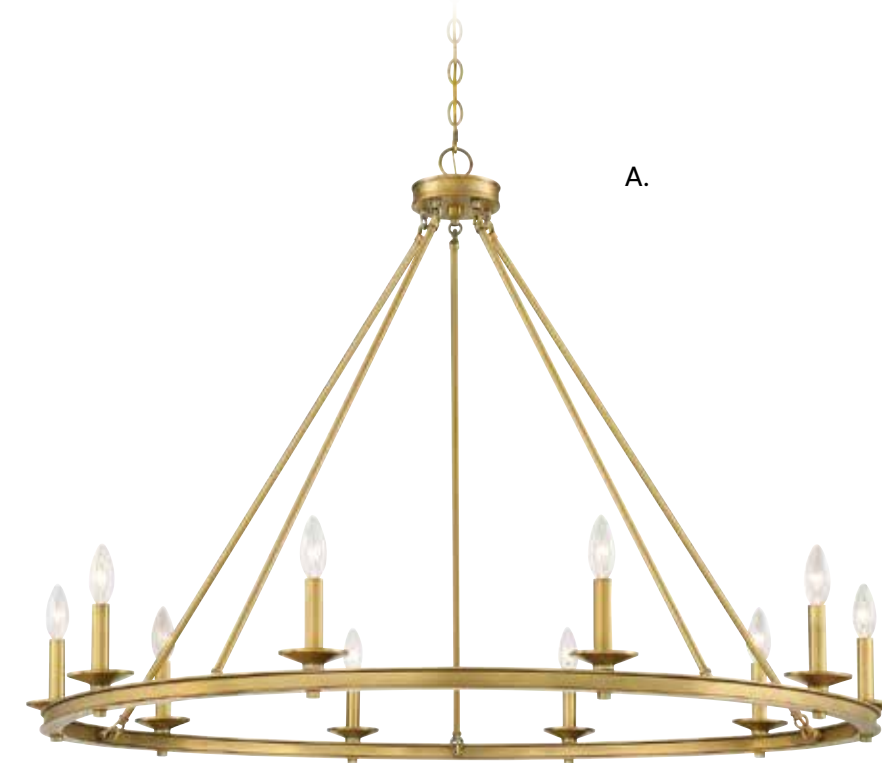

MIDDLETON



Includes 120" chain & wire

MIDDLETON



A. 1-312-15-322
15-Light Chandelier
Warm Brass Finish
45"W x 42"H
15C 60W
Metal Candle Covers

B. 1-312-15-89
15-Light Chandelier
Matte Black Finish
45"W x 42"H
15C 60W
Metal Candle Covers



Includes 120" chain & wire

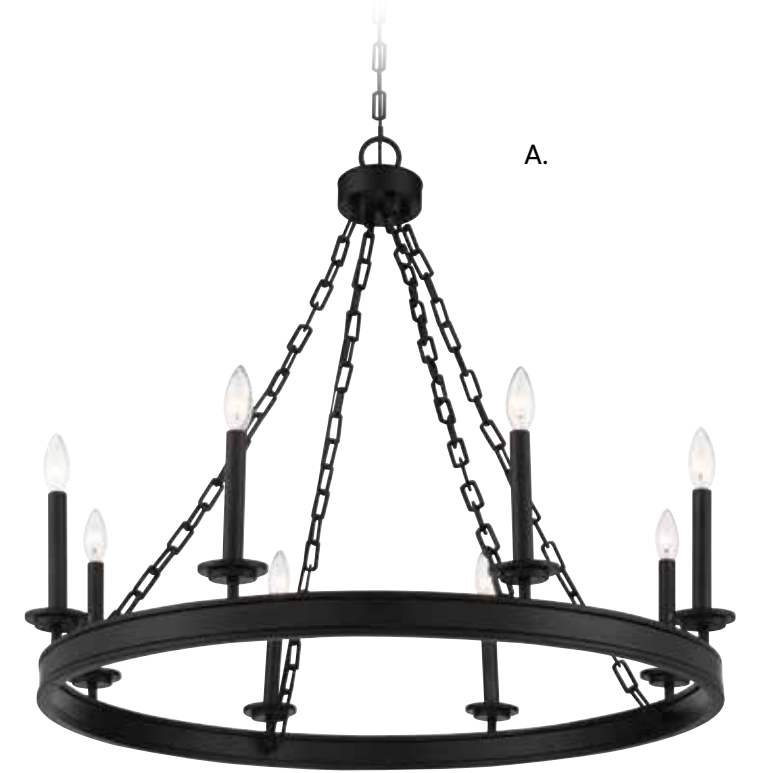

A. 1-4404-8-89
8-Light Chandelier
Matte Black Finish
34"W x 29-1/2"H
8C 60W
Metal Candle Covers

B. 1-4404-8-322
8-Light Chandelier
Warm Brass Finish
34"W x 29-1/2"H
8C 60W
Metal Candle Covers



A.

A. 1-4405-10-322
10-Light Chandelier
Warm Brass Finish
45"W x 33"H
10C 60W
Metal Candle Covers



B.

B. 1-4405-10-89
10-Light Chandelier
Matte Black Finish
45"W x 33"H
10C 60W
Metal Candle Covers



Includes 120" chain & wire



A. 1-4406-15-89
15-Light Chandelier
Matte Black Finish
45"W x 43"H
15C 60W
Metal Candle Covers

Includes 120" chain & wire



B. 1-4406-15-322
15-Light Chandelier
Warm Brass Finish
45"W x 43"H
15C 60W
Metal Candle Covers

A.

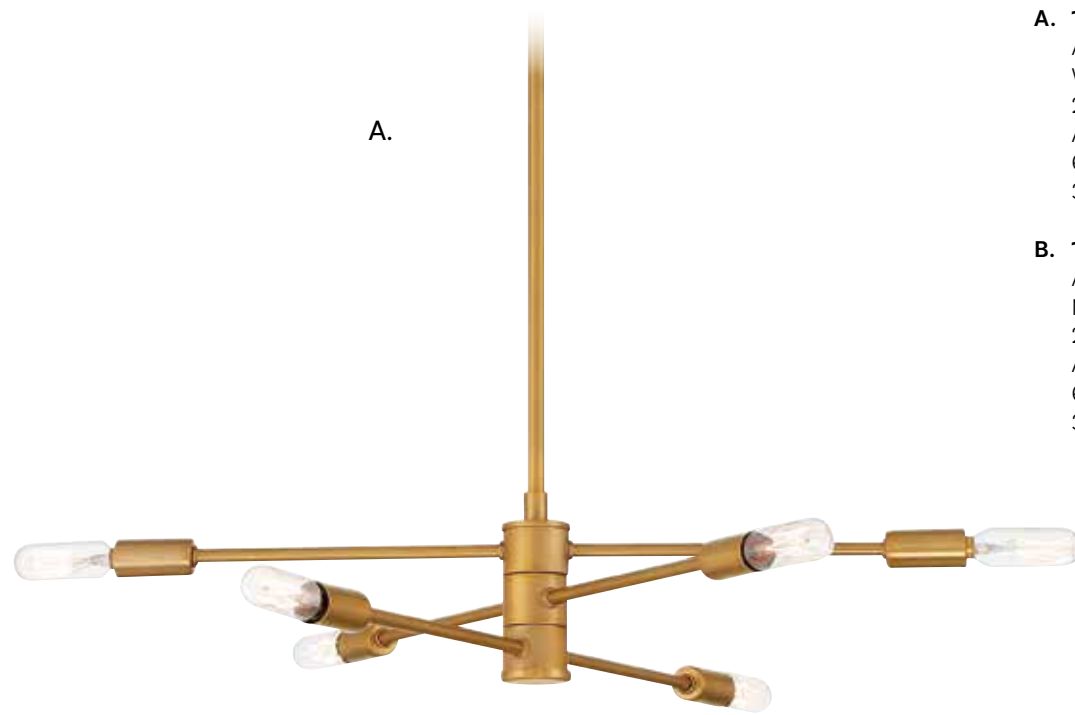

A. 1-7000-6-322
Adjustable 6-Light Chandelier
Warm Brass Finish
21-3/4"W x 7"H
Adj H 7" - 61"
6C 60W
30° Swivel

B. 1-7000-6-89
Adjustable 6-Light Chandelier
Matte Black Finish
21-3/4"W x 7"H
Adj H 7" - 61"
6C 60W
30° Swivel

B.

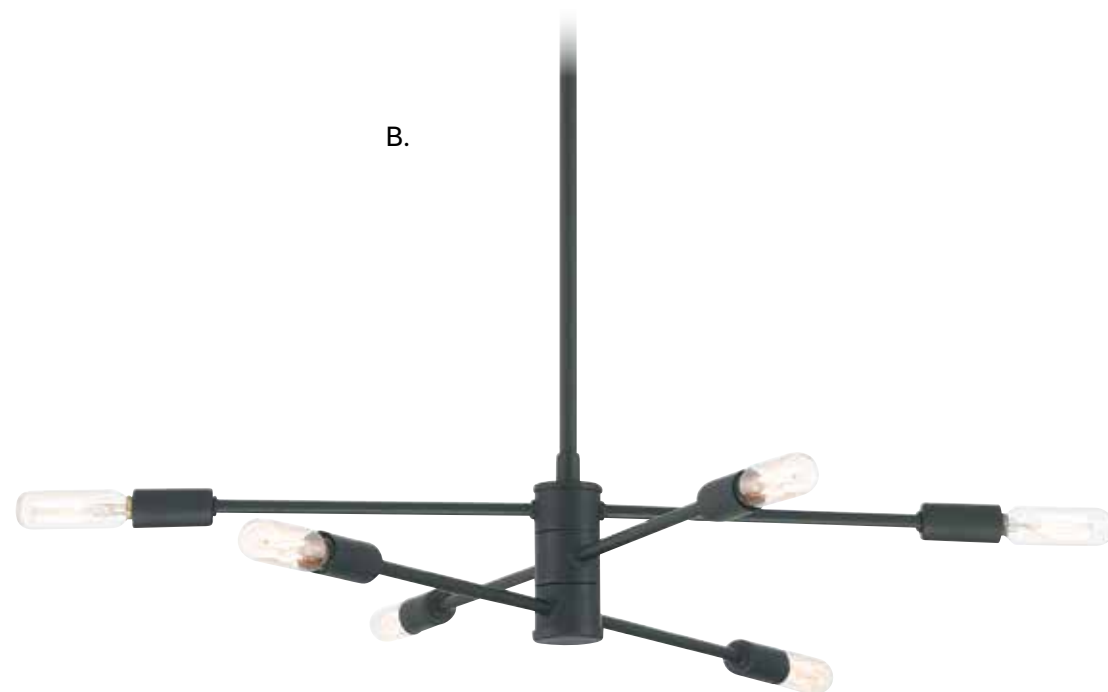

C. 1-7000-6-77
Adjustable 6-Light Chandelier
Bronze w/ Brass Accents
21-3/4"W x 7"H
Adj H 7" - 61"
6C 60W
30° Swivel

C.

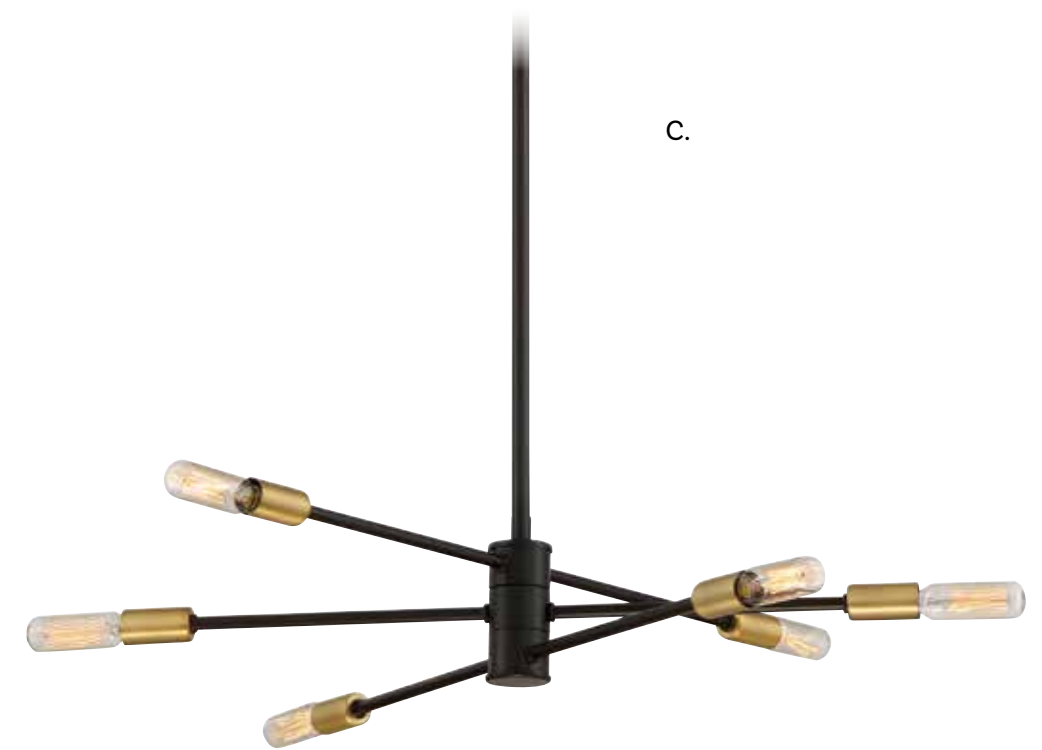

D. 1-7000-6-109
Adjustable 6-Light Chandelier
Polished Nickel Finish
21-3/4"W x 7"H
Adj H 7" - 61"
6C 60W
30° Swivel

D.

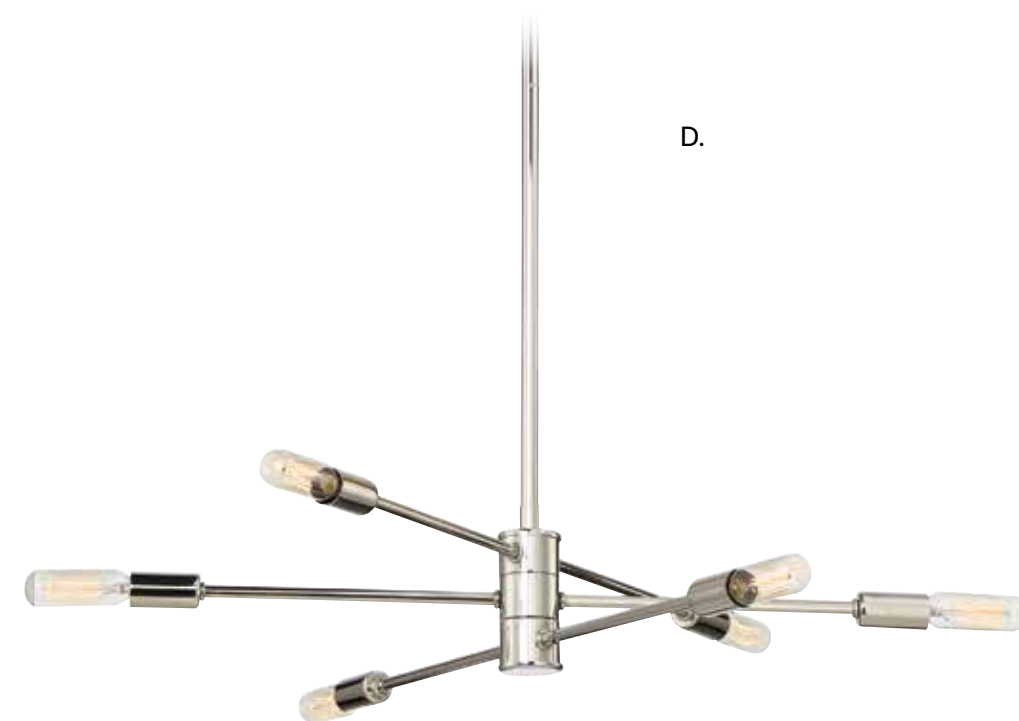

Includes 12" & 6" extensions - additional stems available - **7-EXT**
The arms of the Chandeliers are adjustable and can rotate into different positions

A.

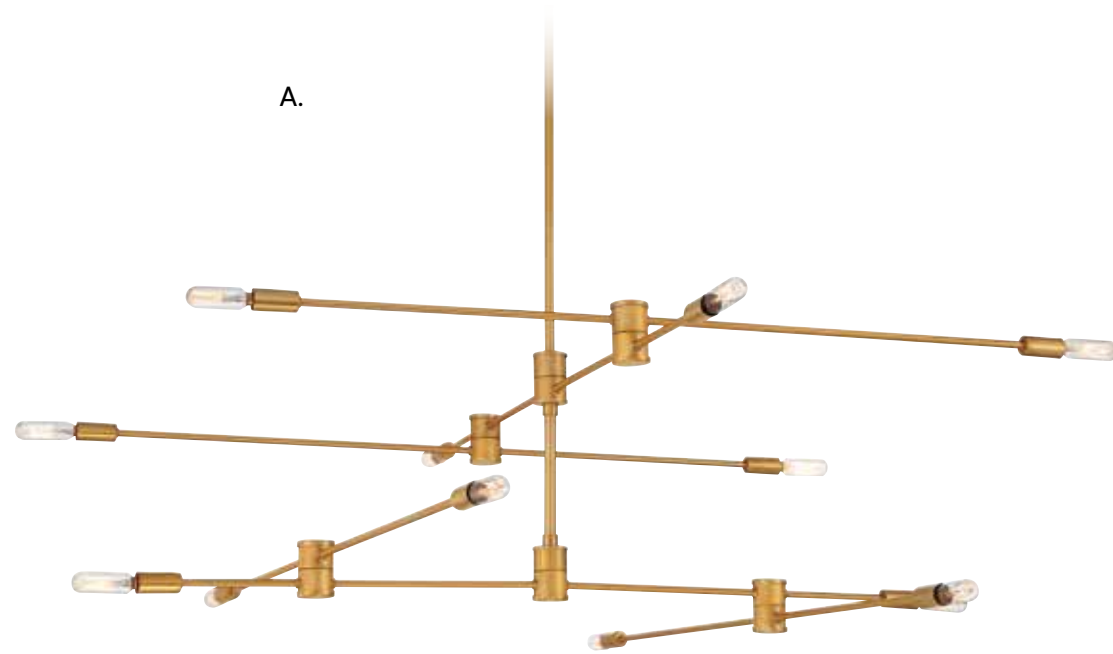

A. 1-7001-12-322
Adjustable
12-Light Chandelier
Warm Brass Finish
54-1/4"W x 15"H
Adj H 15" - 69"
12C 60W
30° Swivel

B. 1-7001-12-89
Adjustable
12-Light Chandelier
Matte Black Finish
54-1/4"W x 15"H
Adj H 15" - 69"
12C 60W
30° Swivel

B.

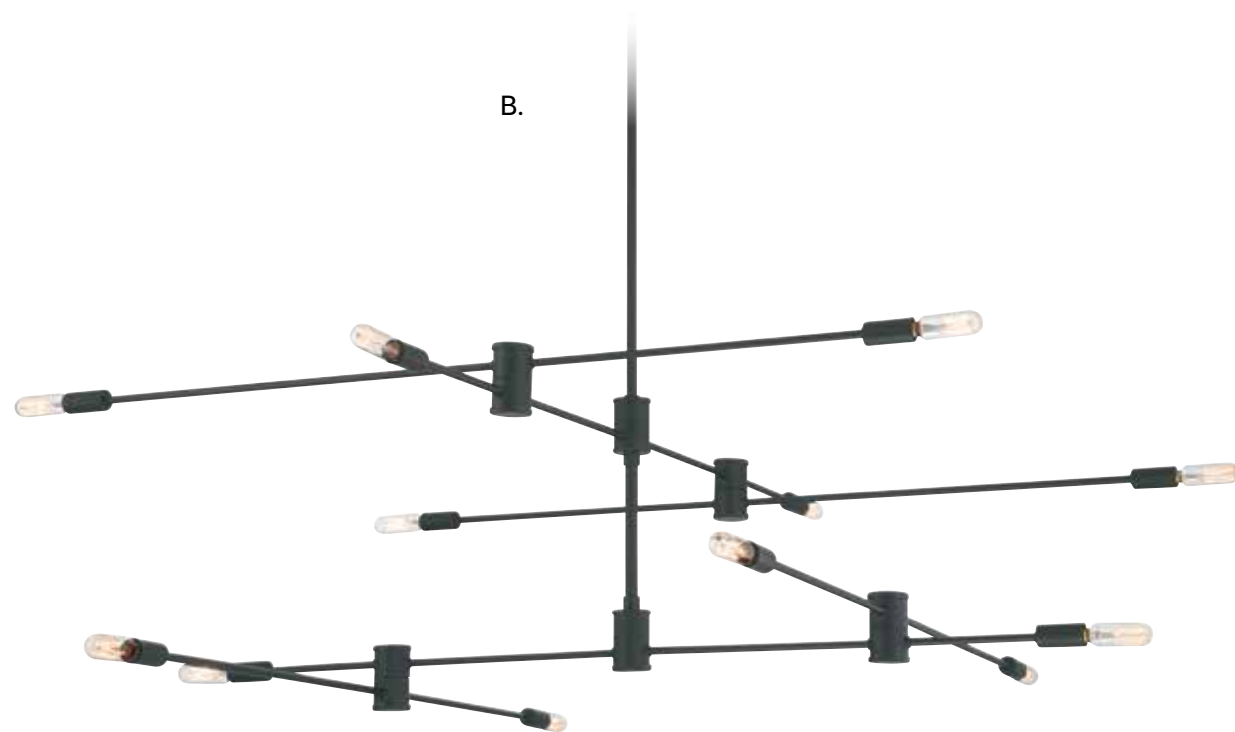

C. 1-7001-12-109
Adjustable
12-Light Chandelier
Polished Nickel Finish
54-1/4"W x 15"H
Adj H 15" - 69"
12C 60W
30° Swivel

C.

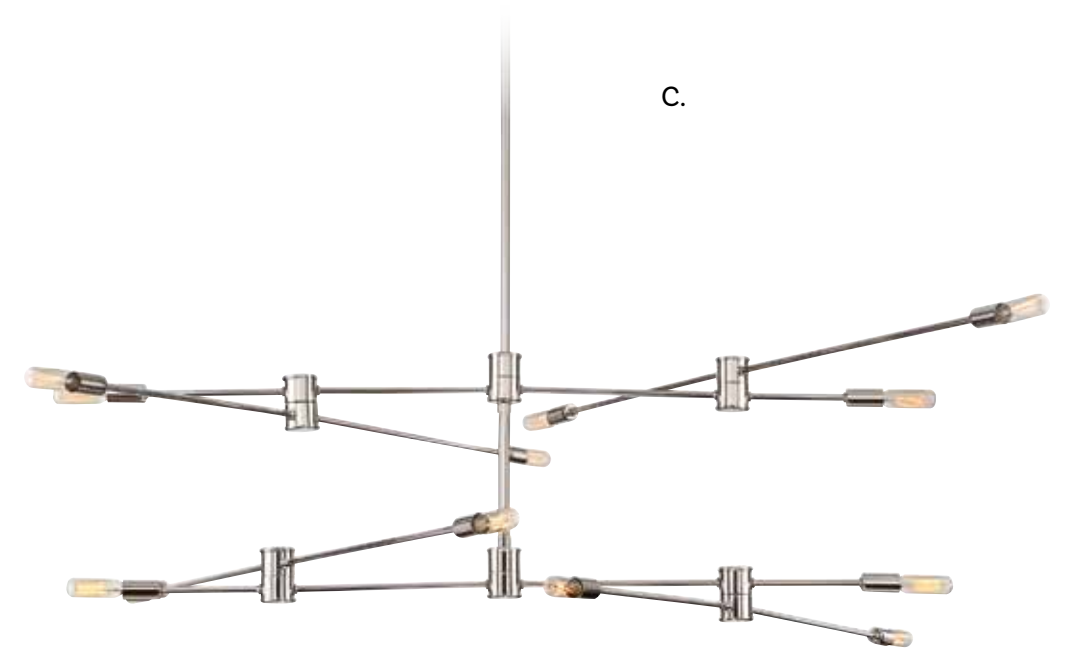

D. 1-7001-12-77
Adjustable
12-Light Chandelier
Bronze w/ Brass Accents
54-1/4"W x 15"H
Adj H 15" - 69"
12C 60W
30° Swivel

D.

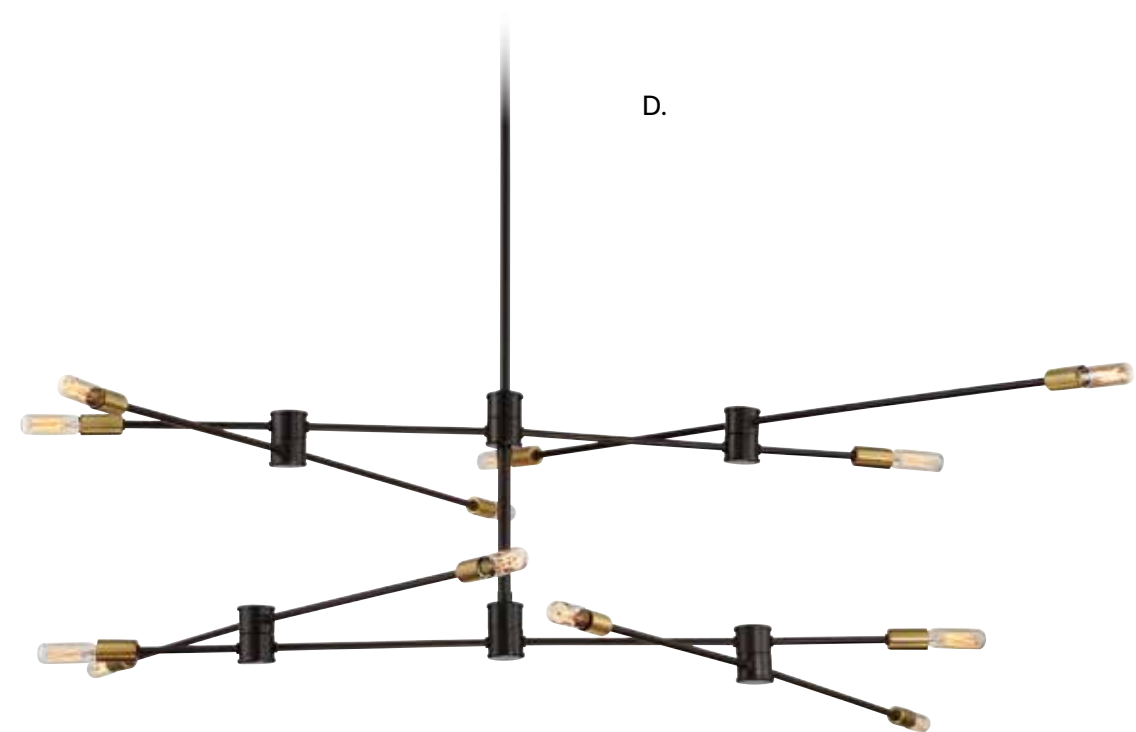

Includes 12" & 6" extensions - additional stems available - **7-EXT**
The arms of the Chandeliers are adjustable and can rotate into different positions

SALERNO



A. 1-2221-6-109
6-Light Chandelier
Polished Nickel Finish
42"W x 25"H
6C 60W
Metal Candle Covers

B. 1-2221-6-89
6-Light Chandelier
Matte Black Finish
42"W x 25"H
6C 60W
Metal Candle Covers

C. 1-2221-6-83
6-Light Chandelier
Bisque White Finish
42"W x 25"H
6C 60W
Metal Candle Covers

D. 1-2221-6-322
6-Light Chandelier
Warm Brass Finish
42"W x 25"H
6C 60W
Metal Candle Covers

SALERNO

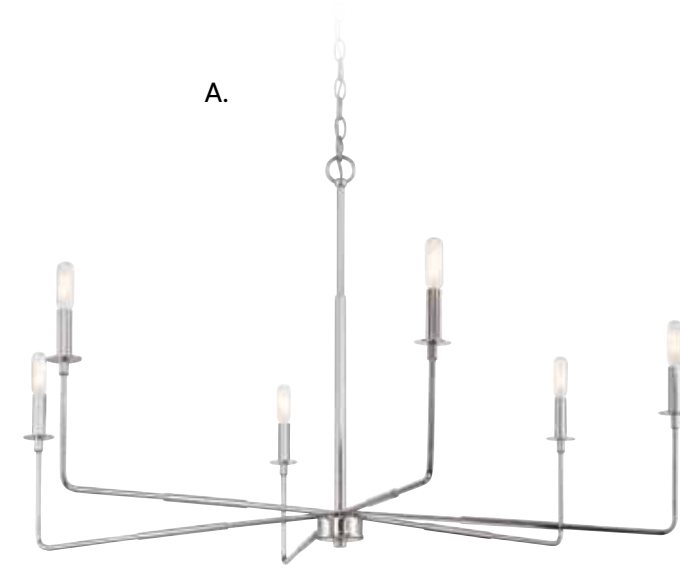

A.

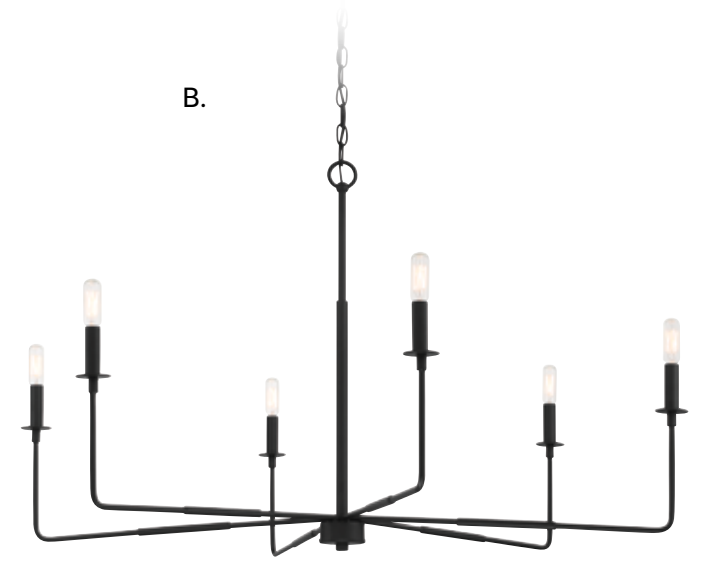

B.

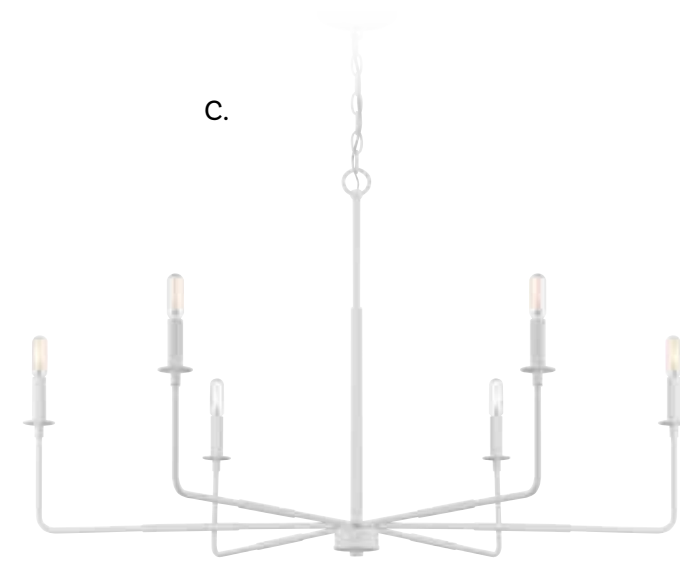

C.

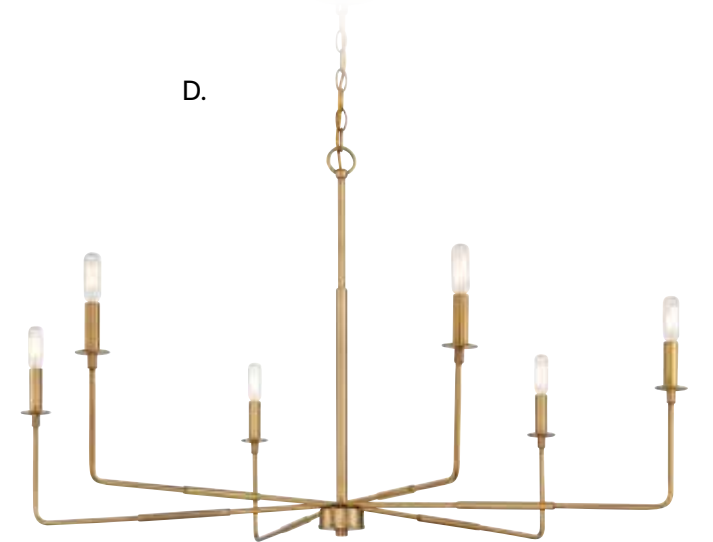

D.

Includes 120" chain & wire

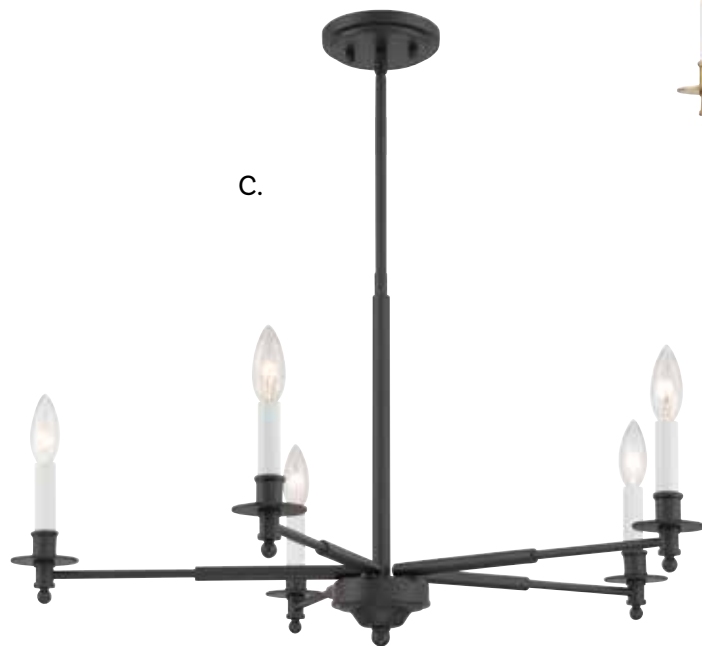
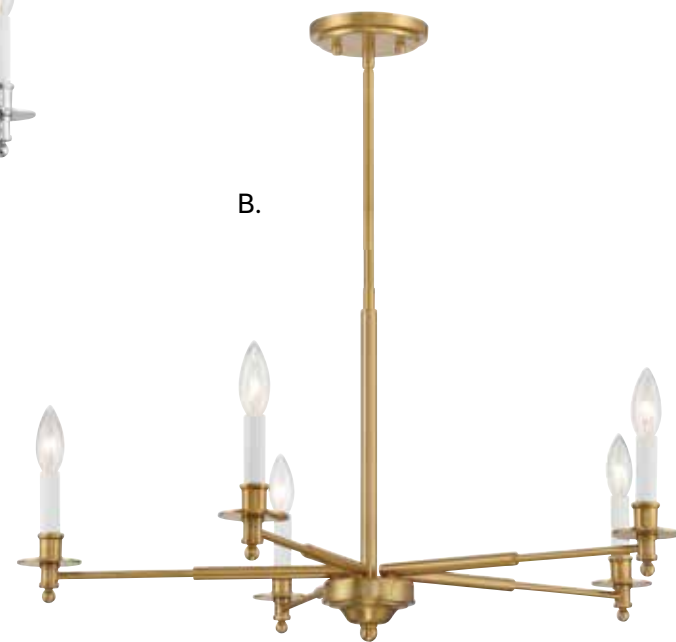
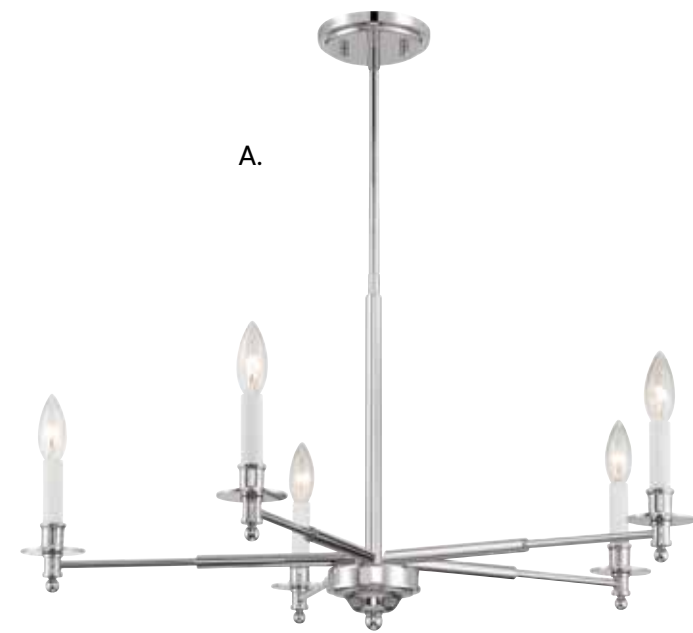

Includes 12" & 6" extensions - additional stems available - **7-EXT**



Dual Mount Hanging System

A. 1-4410-5-109
 5-Light Chandelier
 Polished Nickel Finish
 30"W x 15-1/2"H
 Adj H 15-1/2" - 69-1/2"
 5C 60W
 White Candle Covers

B. 1-4410-5-322
 5-Light Chandelier
 Warm Brass Finish
 30"W x 15-1/2"H
 Adj H 15-1/2" - 69-1/2"
 5C 60W
 White Candle Covers

C. 1-4410-5-89
 5-Light Chandelier
 Matte Black Finish
 30"W x 15-1/2"H
 Adj H 15-1/2" - 69-1/2"
 5C 60W
 White Candle Covers



Includes 12" & 6" extensions - additional stems available - **7-EXT**



Dual Mount Hanging System

A. 1-4412-8-322
 8-Light Chandelier
 Warm Brass Finish
 42"W x 15-1/2"H
 Adj H 15-1/2" - 69-1/2"
 8C 60W
 White Candle Covers

B. 1-4412-8-109
 8-Light Chandelier
 Polished Nickel Finish
 42"W x 15-1/2"H
 Adj H 15-1/2" - 69-1/2"
 8C 60W
 White Candle Covers

C. 1-4412-8-89
 8-Light Chandelier
 Matte Black Finish
 42"W x 15-1/2"H
 Adj H 15-1/2" - 69-1/2"
 8C 60W
 White Candle Covers

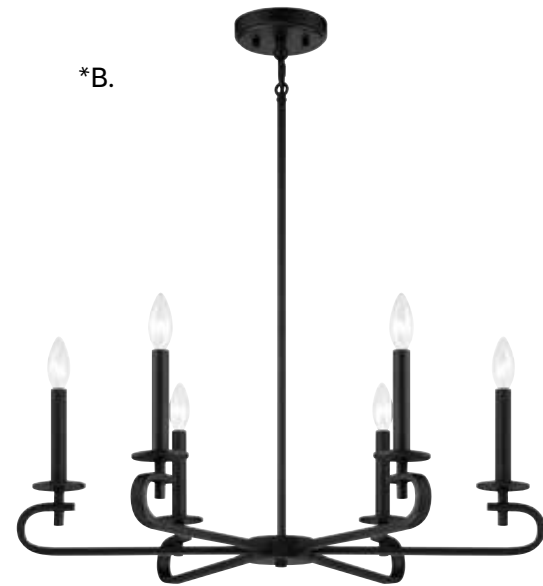

*Includes 12" & 6" extensions - additional stems available - **7-EXT**
 Includes 12" & 6" extensions - additional stems available - **7-EXTLG



Dual Mount Hanging System

- | | | | |
|------------------------------------------------------------------------------------------------------------------------------------|------------------------------------------------------------------------------------------------------------------------------------|------------------------------------------------------------------------------------------------------------------------------------|------------------------------------------------------------------------------------------------------------------------------------|
| A. 1-2451-8-89
8-Light Chandelier
Matte Black Finish
34"W x 9"H
Adj H 9" - 63"
8C 60W
Metal Candle Covers | B. 1-2450-6-89
6-Light Chandelier
Matte Black Finish
28"W x 9"H
Adj H 9" - 63"
6C 60W
Metal Candle Covers | C. 1-2450-6-322
6-Light Chandelier
Warm Brass Finish
28"W x 9"H
Adj H 9" - 63"
6C 60W
Metal Candle Covers | D. 1-2451-8-322
8-Light Chandelier
Warm Brass Finish
34"W x 9"H
Adj H 9" - 63"
8C 60W
Metal Candle Covers |
|------------------------------------------------------------------------------------------------------------------------------------|------------------------------------------------------------------------------------------------------------------------------------|------------------------------------------------------------------------------------------------------------------------------------|------------------------------------------------------------------------------------------------------------------------------------|



Dual Mount Hanging System

- | | | | |
|--------------------------------------------------------------------------------------------------------------------------------------------------------|-----------------------------------------------------------------------------------------------------------------------------------------------------------------------|-----------------------------------------------------------------------------------------------------------------------------------------------------------------------|--------------------------------------------------------------------------------------------------------------------------------------------------------|
| <p>A. 7-2521-4-322
4-Light Pendant
Warm Brass Finish
18"W x 26"H
Adj H 26" - 80"
4C 60W
Soft White
Fabric Shade</p> | <p>B. 1-2520-6-322
6-Light Oval Chandelier
Warm Brass Finish
42"L x 16"W x 23"H
Adj H 23" - 77"
6C 60W
Soft White
Fabric Shade</p> | <p>C. 1-2520-6-89
6-Light Oval Chandelier
Matte Black Finish
42"L x 16"W x 23"H
Adj H 23" - 77"
6C 60W
Soft White
Fabric Shade</p> | <p>D. 7-2521-4-89
4-Light Pendant
Matte Black Finish
18"W x 26"H
Adj H 26" - 80"
4C 60W
Soft White
Fabric Shade</p> |
|--------------------------------------------------------------------------------------------------------------------------------------------------------|-----------------------------------------------------------------------------------------------------------------------------------------------------------------------|-----------------------------------------------------------------------------------------------------------------------------------------------------------------------|--------------------------------------------------------------------------------------------------------------------------------------------------------|



Includes 12" & 6" extensions - additional stems available - 7-EXT



*Includes 12" & 6" extensions - additional stems available - 7-EXT



A. 9-1632-1-173
 1-Light Sconce
 Matte Black w/
 Polished Nickel Accents
 5-3/4"W x 16"H x 8"E
 1C 60W
 White Fabric Shade

B. 1-1630-5-173
 5-Light Chandelier
 Matte Black w/
 Polished Nickel Accents
 28"W x 18"H
 Adj H 18" - 72"
 5C 60W
 White Fabric Shade

C. 1-1630-5-143
 5-Light Chandelier
 Matte Black w/
 Warm Brass Accents
 28"W x 18"H
 Adj H 18" - 72"
 5C 60W
 White Fabric Shade

D. 9-1632-1-143
 1-Light Sconce
 Matte Black w/
 Warm Brass Accents
 5-3/4"W x 16"H x 8"E
 1C 60W
 White Fabric Shade

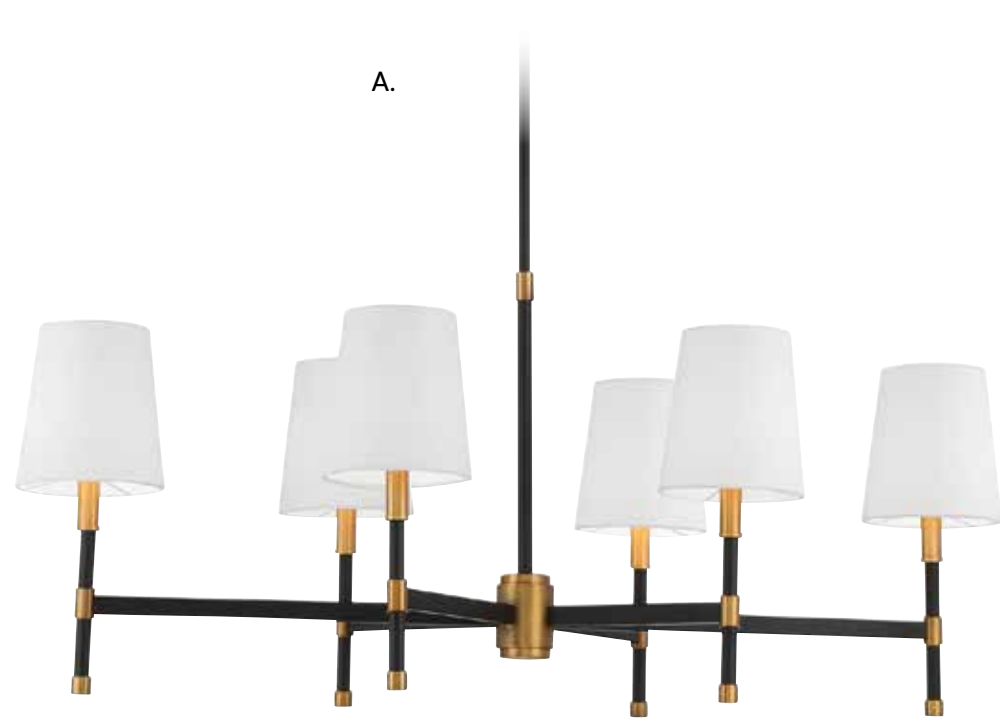

A.



Dual Mount Hanging System

A. 1-1631-6-143
 6-Light Linear Chandelier
 Matte Black w/
 Warm Brass Accents
 41"L x 18"W x 18"H
 Adj H 18" - 72"
 6C 60W
 White Fabric Shade

B. 1-1631-6-173
 6-Light Linear Chandelier
 Matte Black w/
 Polished Nickel Accents
 41"L x 18"W x 18"H
 Adj H 18" - 72"
 6C 60W
 White Fabric Shade



B.

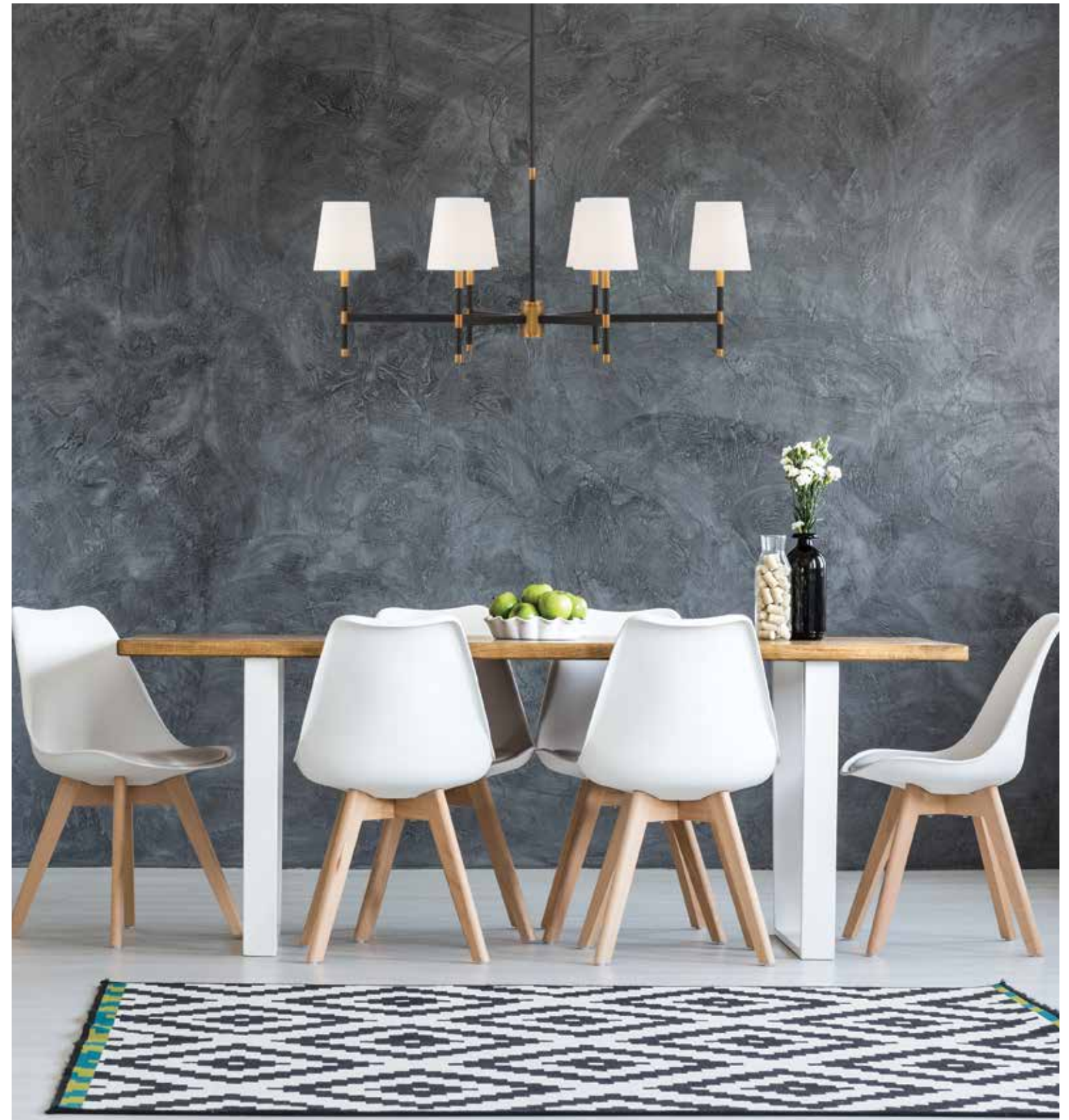

Includes 12" & 6" extensions - additional stems available - 7-EXT

EDGEWOOD



Includes 12" & 6" extensions - additional stems available - 7-EXT

EDGEWOOD



A. 1-1785-6-322
6-Light Linear Chandelier
Warm Brass Finish
35"L X 16-1/8"W x 10"H
Adj H 10" - 64"
6C 60W
Black Fabric Shade

B. 1-1786-5-322
5-Light Linear Chandelier
Warm Brass Finish
32"W x 10"H
Adj H 10" - 64"
5C 60W
Black Fabric Shade

C. 1-1786-5-89
5-Light Linear Chandelier
Matte Black Finish
32"W x 10"H
Adj H 10" - 64"
5C 60W
Oatmeal Fabric Shade

D. 1-1785-6-89
6-Light Linear Chandelier
Matte Black Finish
35"L X 16-1/8"W x 10"H
Adj H 10" - 64"
6C 60W
Oatmeal Fabric Shade



Includes 120" chain & wire



A. 1-1756-6-89
6-Light Linear Chandelier
Matte Black Finish
35"L x 15"W x 23"H
6C 60W
White Fabric Shade

B. 1-1756-6-322
6-Light Linear Chandelier
Warm Brass Finish
35"L x 15"W x 23"H
6C 60W
White Fabric Shade

C. 1-1756-6-109
6-Light Linear Chandelier
Polished Nickel Finish
35"L x 15"W x 23"H
6C 60W
White Fabric Shade



Sconce, Page 227



Includes 12" & 6" extensions - additional stems available - **7-EXT**



Bath, Page 285



Sconce, Page 222



A. 1-2540-5-89
 5-Light Chandelier
 Matte Black Finish
 29"W x 13"H
 Adj H 13" - 67"
 5C 40W
 30° Swivel
 White Fabric Shade
 Metal Candle Covers

B. 1-2540-5-109
 5-Light Chandelier
 Polished Nickel Finish
 29"W x 13"H
 Adj H 13" - 67"
 5C 40W
 30° Swivel
 White Fabric Shade
 Metal Candle Covers

C. 1-2540-5-322
 5-Light Chandelier
 Warm Brass Finish
 29"W x 13"H
 Adj H 13" - 67"
 5C 40W
 30° Swivel
 White Fabric Shade
 Metal Candle Covers

CAMERON



Includes 12" & 6" extensions - additional stems available - 7-EXT

CAMERON



A.

A. 1-2541-9-89
9-Light Chandelier
Matte Black Finish
35"W x 24"H
Adj H 24" - 78"
9C 40W
30° Swivel
White Fabric Shade
Metal Candle Covers



B.

B. 1-2541-9-322
9-Light Chandelier
Warm Brass Finish
35"W x 24"H
Adj H 24" - 78"
9C 40W
30° Swivel
White Fabric Shade
Metal Candle Covers



C.

C. 1-2541-9-109
9-Light Chandelier
Polished Nickel Finish
35"W x 24"H
Adj H 24" - 78"
9C 40W
30° Swivel
White Fabric Shade
Metal Candle Covers



A. 1-3392-4-89
4-Light Chandelier
Matte Black Finish
24"W x 25"H
4C 60W
Clear Ribbed Glass

B. 1-3394-8-89
8-Light Chandelier
Matte Black Finish
36"W x 32-1/2"H
8C 60W
Clear Ribbed Glass

C. 1-3394-8-322
8-Light Chandelier
Warm Brass Finish
36"W x 32-1/2"H
8C 60W
Clear Ribbed Glass

D. 1-3392-4-322
4-Light Chandelier
Warm Brass Finish
24"W x 25"H
4C 60W
Ribbed Glass



Pendant, Page 178



A.



B.



C.

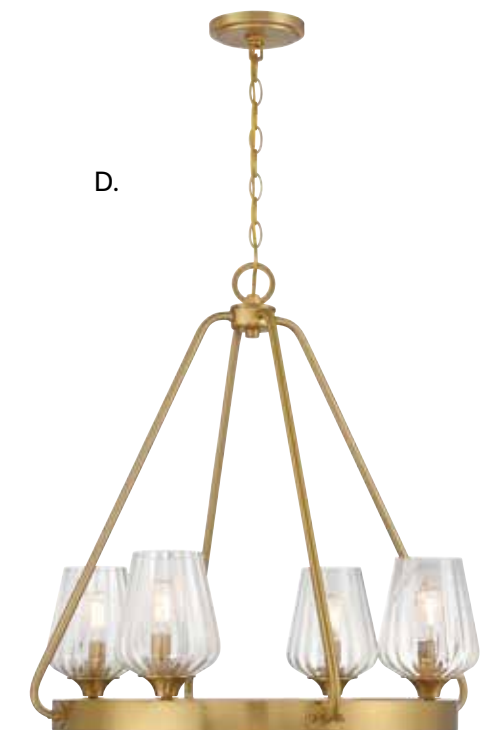

D.

Includes 120" chain & wire



Includes 120" chain & wire



- A. 7-1803-3-322**
3-Light Pendant
Warm Brass Finish
12"W x 25-1/2"H
3C 60W
Clear Water Glass
- B. 7-1803-3-SN**
3-Light Pendant
Satin Nickel Finish
12"W x 25-1/2"H
3C 60W
Clear Water Glass
- C. 7-1803-3-89**
3-Light Pendant
Matte Black Finish
12"W x 25-1/2"H
3C 60W
Clear Water Glass
- D. 7-1804-4-322**
4-Light Pendant
Warm Brass Finish
18"W x 39-1/2"H
4C 60W
Clear Water Glass
- E. 7-1804-4-SN**
1-Light Pendant
Satin Nickel Finish
18"W x 39-1/2"H
4C 60W
Clear Water Glass
Clear Glass
- F. 7-1804-4-89**
1-Light Pendant
Matte Black Finish
18"W x 39-1/2"H
4C 60W
Clear Water Glass



Sconce, Page 235



A.



B.

A. 6-1802-3-89
3-Light Semi-Flush
Matte Black Finish
15"W x 13-1/2"H
3C 60W
Clear Water Glass

B. 6-1802-3-322
3-Light Semi-Flush
Warm Brass Finish
15"W x 13-1/2"H
3C 60W
Clear Water Glass

C. 6-1802-3-SN
3-Light Semi-Flush
Satin Nickel Finish
15"W x 13-1/2"H
3C 60W
Clear Water Glass



C.

CALHOUN



*Includes 120" chain & wire

**Includes 12" & 6" extensions - additional stems available - 7-EXT

CALHOUN



Dual Mount Hanging System



*A.



*B.

A. 1-1021-5-89
5-Light Chandelier
Matte Black Finish
25"W x 23"H
5E 60W
Clear Glass

B. 7-1025-3-89
3-Light Pendant
Matte Black Finish
15"W x 18"H
3E 60W
Clear Glass

C. 1-1023-5-89
5-Light Linear Chandelier
Matte Black Finish
40"L x 5"W x 10"H
Adj H 10" - 62"
5E 60W
Clear Glass



**C.



Mini-Pendant, Page 181



Pendant, Page 181



Ceiling, Page 204



Bath, Page 251



A. 7-1025-3-SN
 3-Light Pendant
 Satin Nickel Finish
 15"W x 18"H
 3E 60W
 Clear Glass

B. 1-1021-5-SN
 5-Light Chandelier
 Satin Nickel Finish
 25"W x 22"H
 5E 60W
 Clear Glass

C. 1-1023-5-SN
 5-Light Linear Chandelier
 Satin Nickel Finish
 40"L x 5"W x 10"H
 Adj H 10" - 62"
 5E 60W
 Clear Glass

D. 1-1021-5-322
 5-Light Chandelier
 Warm Brass Finish
 25"W x 22"H
 5E 60W
 Clear Glass

E. 7-1025-3-322
 3-Light Pendant
 Warm Brass Finish
 15"W x 18"H
 3E 60W
 Clear Glass

F. 1-1023-5-322
 5-Light Linear Chandelier
 Warm Brass Finish
 40"L x 5"W x 10"H
 Adj H 10" - 62"
 5E 60W
 Clear Glass



*Includes 120" chain & wire.

**Includes 12" & 6" extensions - additional stems available - 7-EXT





Pendant, Page 185 Ceiling, Page 198 Ceiling, Page 199



Bath, Page 267 Sconce, Page 268

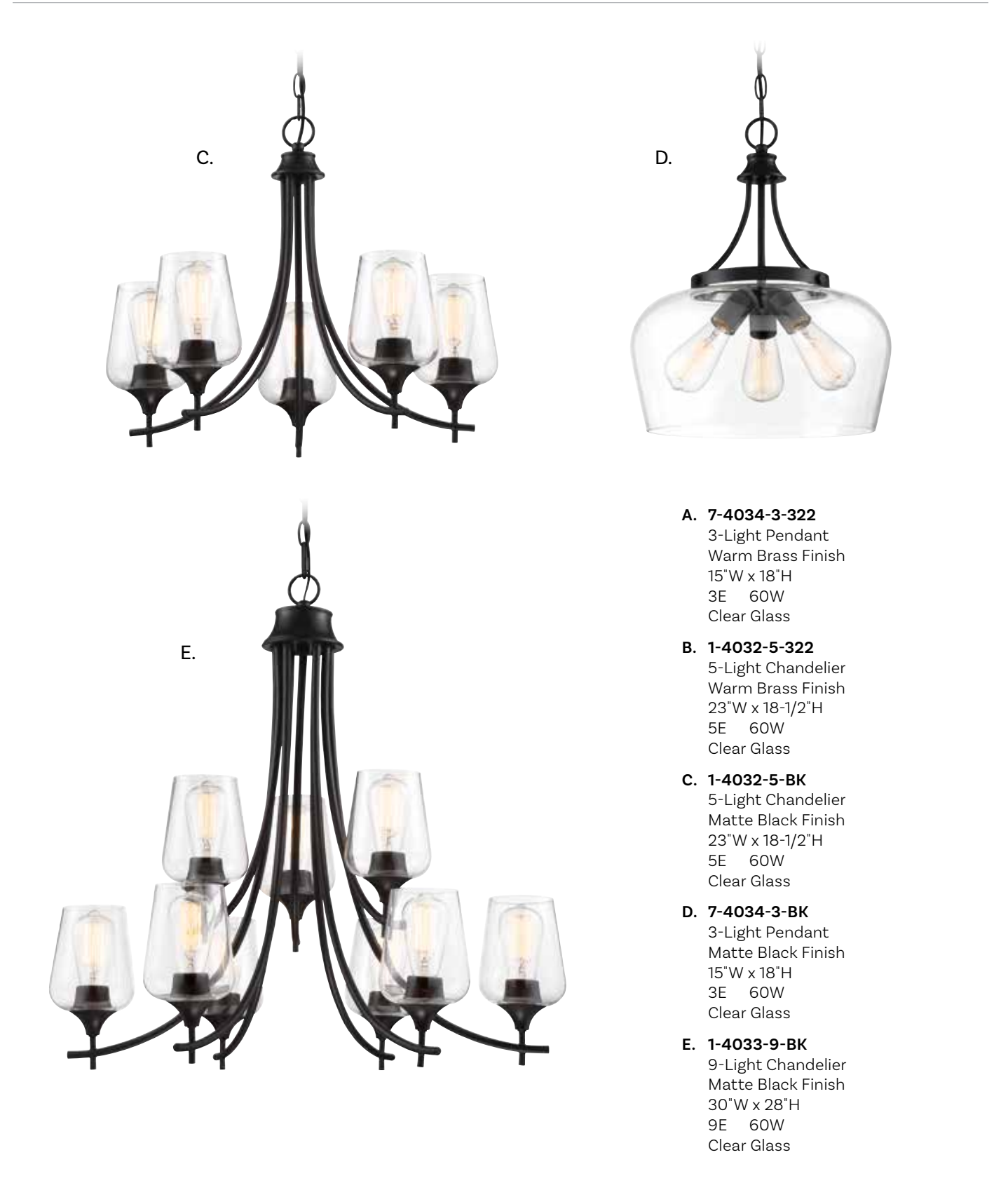

Includes 120" chain & wire

- A. 7-4034-3-322**
3-Light Pendant
Warm Brass Finish
15"W x 18"H
3E 60W
Clear Glass
- B. 1-4032-5-322**
5-Light Chandelier
Warm Brass Finish
23"W x 18-1/2"H
5E 60W
Clear Glass
- C. 1-4032-5-BK**
5-Light Chandelier
Matte Black Finish
23"W x 18-1/2"H
5E 60W
Clear Glass
- D. 7-4034-3-BK**
3-Light Pendant
Matte Black Finish
15"W x 18"H
3E 60W
Clear Glass
- E. 1-4033-9-BK**
9-Light Chandelier
Matte Black Finish
30"W x 28"H
9E 60W
Clear Glass



A.



B.

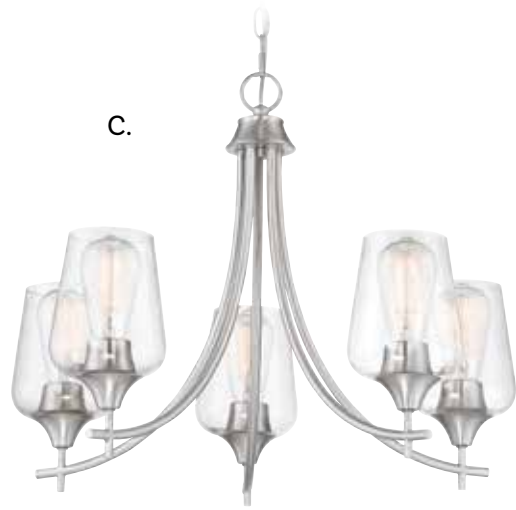

C.



D.



E.



F.



G.

A. 7-4034-3-SN
3-Light Pendant
Satin Nickel Finish
15"W x 18"H
3E 60W
Clear Glass

B. 1-4033-9-SN
9-Light Chandelier
Satin Nickel Finish
30"W x 28"H
9E 60W
Clear Glass

C. 1-4032-5-SN
5-Light Chandelier
Satin Nickel Finish
23"W x 18-1/2"H
5E 60W
Clear Glass

D. 1-4032-5-13
5-Light Chandelier
English Bronze Finish
23"W x 18-1/2"H
5E 60W
Clear Glass

E. 7-4034-3-13
3-Light Pendant
English Bronze Finish
15"W x 18"H
3E 60W
Clear Glass

F. 7-4034-3-11
3-Light Pendant
Polished Chrome Finish
15"W x 18"H
3E 60W
Clear Glass

G. 1-4032-5-11
5-Light Chandelier
Polished Chrome Finish
23"W x 18-1/2"H
5E 60W
Clear Glass



Pendant, Page 185



Ceiling, Page 198



Ceiling, Page 199

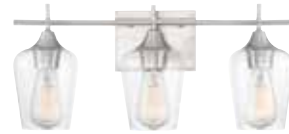

Bath, Page 269



Sconce, Page 245



Pendant, Page 185



Bath, Page 268



Ceiling, Page 199



Ceiling, Page 198



Sconce, Page 245



A. 7-336-1-SN
 1-Light Mini-Pendant
 Satin Nickel Finish
 6-1/2"W x 14-1/2"H
 1E 60W
 White Opal Glass

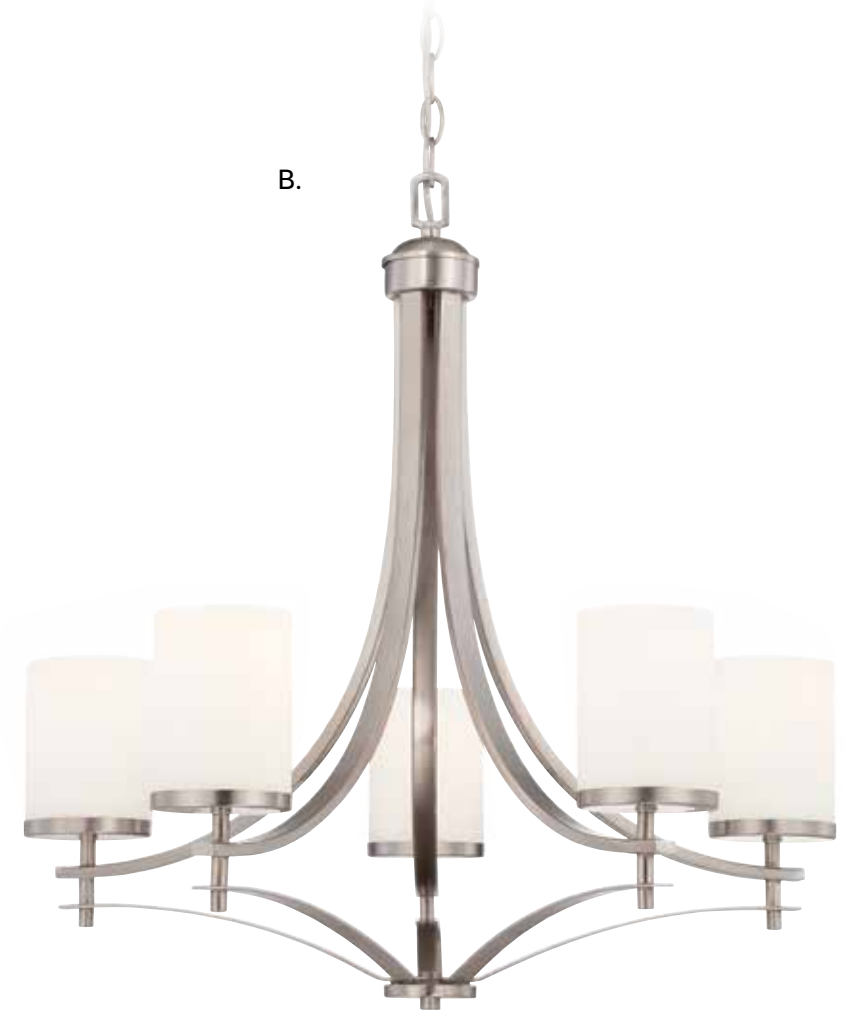

B. 1-330-5-SN
 5-Light Chandelier
 Satin Nickel Finish
 26"W x 26"H
 5E 60W
 White Opal Glass



Includes 120" chain & wire

Bath, Page 293

Sconce, Page 244



*A.



B.

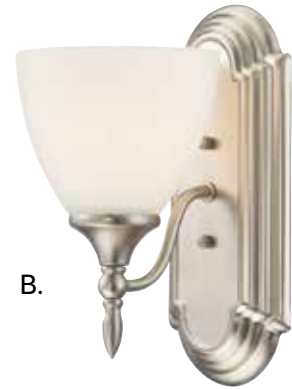

C.



A. 1-1001-5-SN
5-Light Chandelier
Satin Nickel Finish
26"W x 27-1/2"H
5E 60W
Frosted White Glass

B. 9-1007-1-SN
1-Light Sconce
Satin Nickel Finish
5-1/2"W x 10-3/4"H x
7-1/2"E
1E 60W
Frosted White Glass

C. 6-1005-3-SN
3-Light Semi-Flush
Satin Nickel Finish
18"W x 15-1/2"H
3E 60W
Frosted White Glass

D. 7-1003-3-SN
3-Light Pendant
Satin Nickel Finish
16"W x 34"H
3E 60W
Frosted White Glass

E. 1-1000-3-SN
3-Light Chandelier
Satin Nickel Finish
18-1/2"W x 15"H
3E 60W
Frosted White Glass

F. 7-1004-3-SN
3-Light Pendant
Satin Nickel Finish
18"W x 22"H
3E 60W
Frosted White Glass

G. 1-1008-5-SN
5-Light Chandelier
Satin Nickel Finish
21"W x 27-1/2"H
5C 60W
White Candle Covers

*D.



*E.



*F.



*G.



*Includes 120" chain & wire



Pendant, Page 183



Bath, Page 294



- | | | | | |
|------------------------------------------------------------------------------------------------------------------|----------------------------------------------------------------------------------------------------------------|---------------------------------------------------------------------------------------------------------------|--------------------------------------------------------------------------------------------------------------------|---------------------------------------------------------------------------------------------------------------|
| A. 3-420-3-44
3-Light Pendant
Classic Bronze Finish
10"W x 15"H
3C 60W
Metal Candle Covers | B. 3-420-3-SN
3-Light Pendant
Satin Nickel Finish
10"W x 15"H
3C 60W
Metal Candle Covers | C. 3-420-3-322
3-Light Pendant
Warm Brass Finish
10"W x 15"H
3C 60W
Metal Candle Covers | D. 3-420-3-109
3-Light Pendant
Polished Nickel Finish
10"W x 15"H
3C 60W
Metal Candle Covers | E. 3-420-3-89
3-Light Pendant
Matte Black Finish
10"W x 15"H
3C 60W
Metal Candle Covers |
|------------------------------------------------------------------------------------------------------------------|----------------------------------------------------------------------------------------------------------------|---------------------------------------------------------------------------------------------------------------|--------------------------------------------------------------------------------------------------------------------|---------------------------------------------------------------------------------------------------------------|



Includes 120" chain & wire



Includes 120" chain & wire



- | | | | | |
|------------------------------------------------------------------------------------------------------------------------------|----------------------------------------------------------------------------------------------------------------------------|---------------------------------------------------------------------------------------------------------------------------|--------------------------------------------------------------------------------------------------------------------------------|---------------------------------------------------------------------------------------------------------------------------|
| <p>A. 3-421-4-44
4-Light Pendant
Classic Bronze Finish
17"W x 26"H
4C 60W
Metal Candle Covers</p> | <p>B. 3-421-4-SN
4-Light Pendant
Satin Nickel Finish
17"W x 26"H
4C 60W
Metal Candle Covers</p> | <p>C. 3-421-4-322
4-Light Pendant
Warm Brass Finish
17"W x 26"H
4C 60W
Metal Candle Covers</p> | <p>D. 3-421-4-109
4-Light Pendant
Polished Nickel Finish
17"W x 26"H
4C 60W
Metal Candle Covers</p> | <p>E. 3-421-4-89
4-Light Pendant
Matte Black Finish
17"W x 26"H
4C 60W
Metal Candle Covers</p> |
|------------------------------------------------------------------------------------------------------------------------------|----------------------------------------------------------------------------------------------------------------------------|---------------------------------------------------------------------------------------------------------------------------|--------------------------------------------------------------------------------------------------------------------------------|---------------------------------------------------------------------------------------------------------------------------|

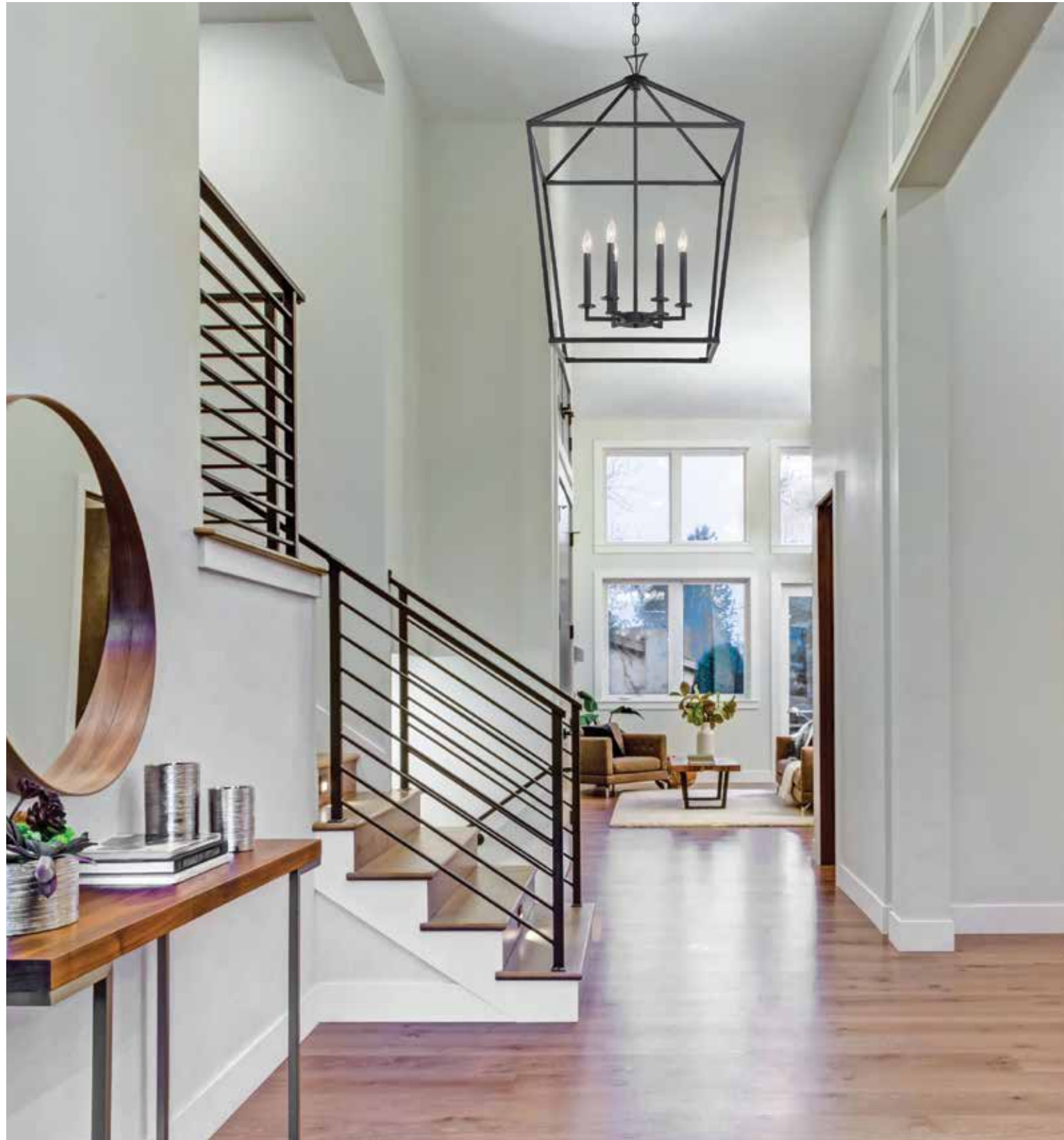

Includes 120" chain & wire

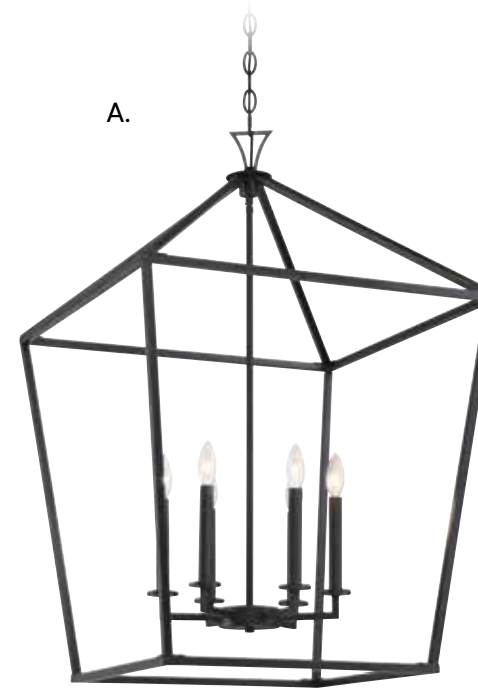

A. 3-422-6-44
6-Light Pendant
Classic Bronze Finish
24"W x 36-1/2"H
6C 60W
Metal Candle Covers

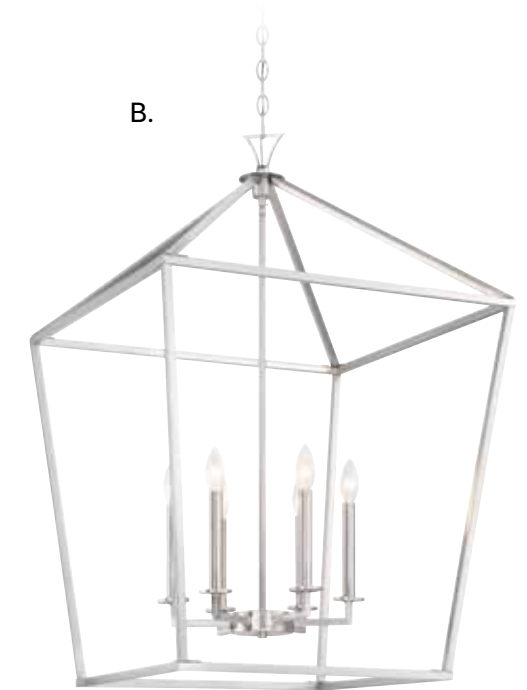

B. 3-422-6-SN
6-Light Pendant
Satin Nickel Finish
24"W x 36-1/2"H
6C 60W
Metal Candle Covers

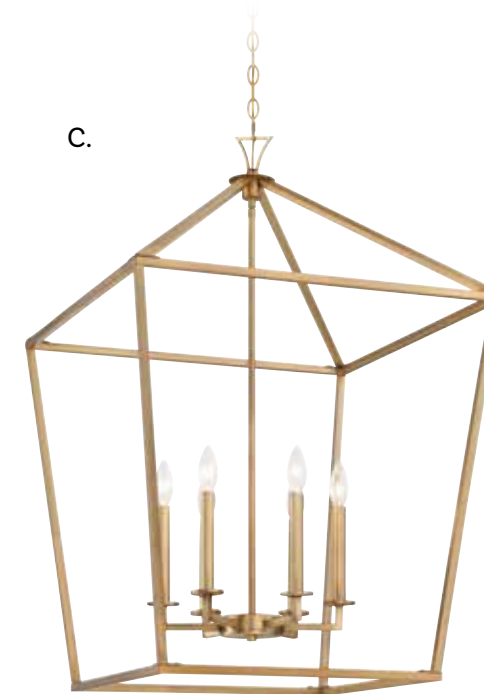

C. 3-422-6-322
6-Light Pendant
Warm Brass Finish
24"W x 36-1/2"H
6C 60W
Metal Candle Covers

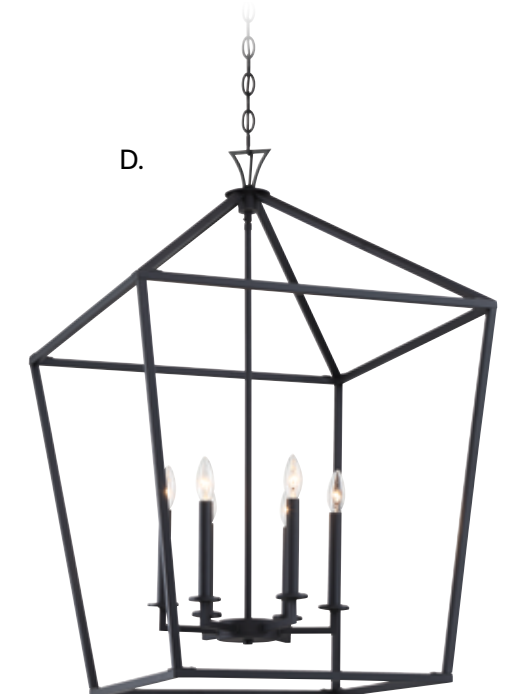

D. 3-422-6-89
6-Light Pendant
Matte Black Finish
24"W x 36-1/2"H
6C 60W
Metal Candle Covers

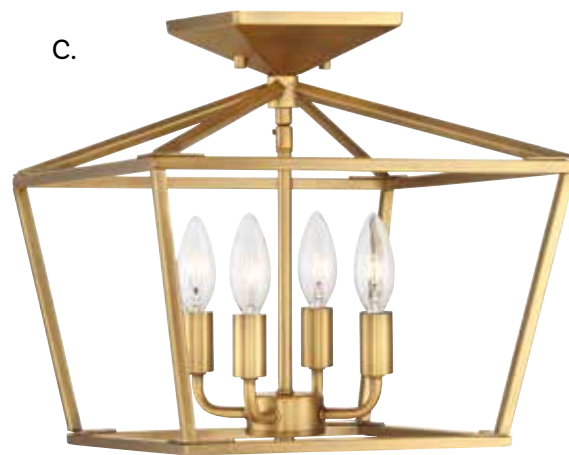

- | | | | | |
|---------------------------------------------------------------------------------------------------------------------------------|-------------------------------------------------------------------------------------------------------------------------------|------------------------------------------------------------------------------------------------------------------------------|-----------------------------------------------------------------------------------------------------------------------------------|------------------------------------------------------------------------------------------------------------------------------|
| <p>A. 6-328-4-44
4-Light Semi-Flush
Classic Bronze Finish
13"W x 13"H
4C 60W
Metal Candle Covers</p> | <p>B. 6-328-4-SN
4-Light Semi-Flush
Satin Nickel Finish
13"W x 13"H
4C 60W
Metal Candle Covers</p> | <p>C. 6-328-4-322
4-Light Semi-Flush
Warm Brass Finish
13"W x 13"H
4C 60W
Metal Candle Covers</p> | <p>D. 6-328-4-109
4-Light Semi-Flush
Polished Nickel Finish
13"W x 13"H
4C 60W
Metal Candle Covers</p> | <p>E. 6-328-4-89
4-Light Semi-Flush
Matte Black Finish
13"W x 13"H
4C 60W
Metal Candle Covers</p> |
|---------------------------------------------------------------------------------------------------------------------------------|-------------------------------------------------------------------------------------------------------------------------------|------------------------------------------------------------------------------------------------------------------------------|-----------------------------------------------------------------------------------------------------------------------------------|------------------------------------------------------------------------------------------------------------------------------|



Includes 120" chain & wire

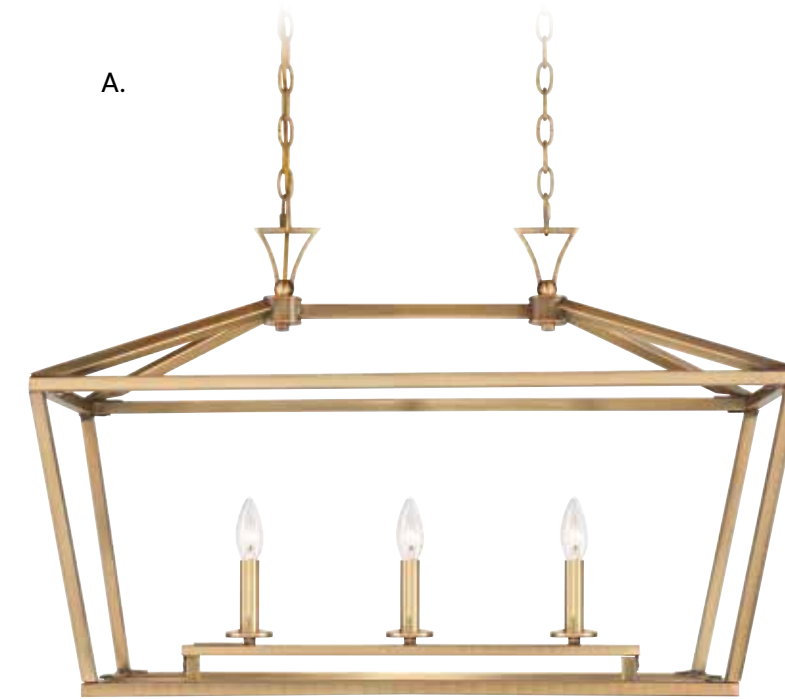

A.

A. 1-423-3-322
 3-Light Linear
 Chandelier
 Warm Brass Finish
 32"L x 16"W x 21"H
 3C 60W
 Metal Candle Covers

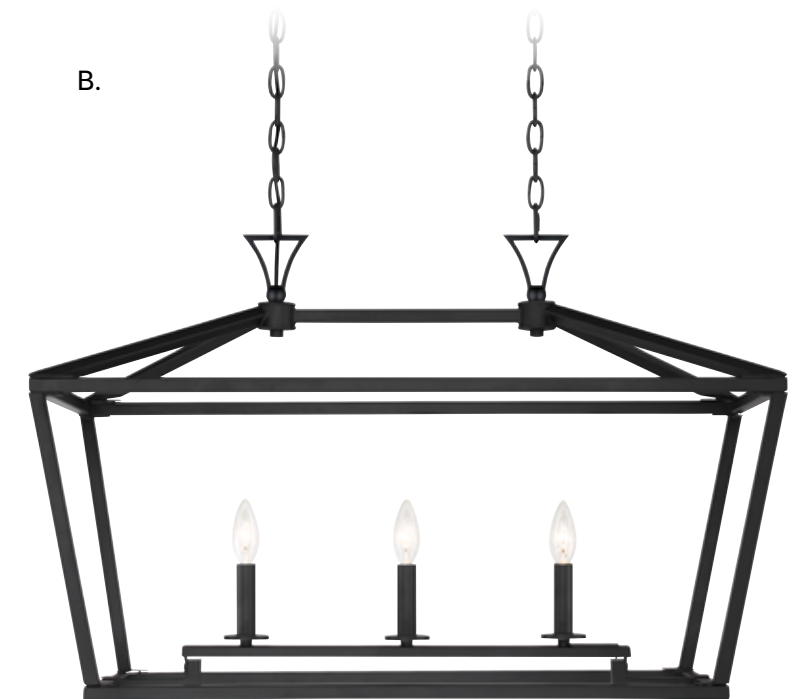

B.

B. 1-423-3-89
 3-Light Linear
 Chandelier
 Matte Black Finish
 32"L x 16"W x 21"H
 3C 60W
 Metal Candle Covers

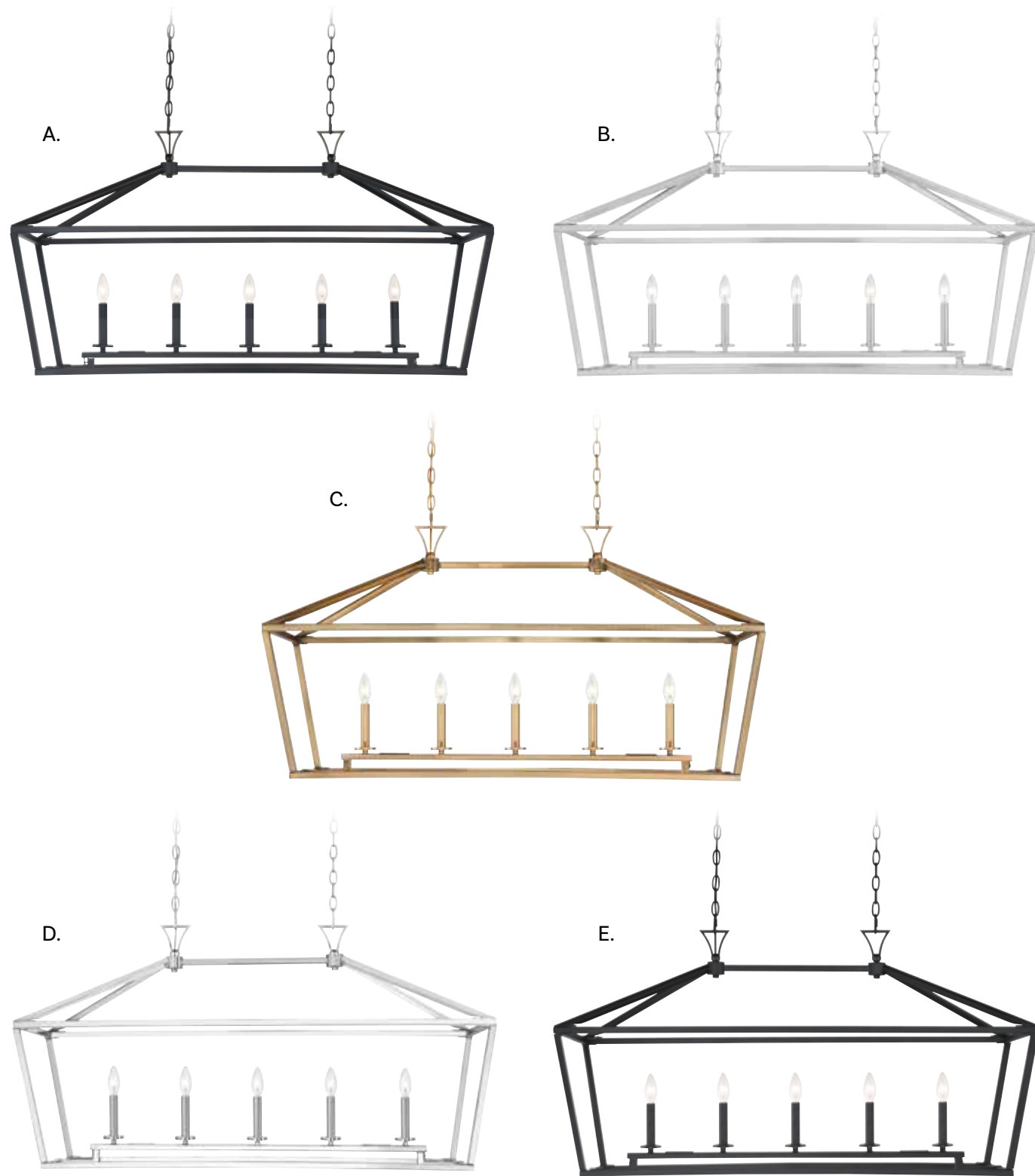

Includes 120" chain & wire



- | | | | | |
|-------------------------------------------------------------------------------------------------------------------------------------------------------|-----------------------------------------------------------------------------------------------------------------------------------------------------|----------------------------------------------------------------------------------------------------------------------------------------------------|---------------------------------------------------------------------------------------------------------------------------------------------------------|----------------------------------------------------------------------------------------------------------------------------------------------------|
| <p>A. 1-424-5-44
5-Light Linear
Chandelier
Classic Bronze Finish
44"L x 16"W x 23-1/2"H
5C 60W
Metal Candle Covers</p> | <p>B. 1-424-5-SN
5-Light Linear
Chandelier
Satin Nickel Finish
44"L x 16"W x 23-1/2"H
5C 60W
Metal Candle Covers</p> | <p>C. 1-424-5-322
5-Light Linear
Chandelier
Warm Brass Finish
44"L x 16"W x 23-1/2"H
5C 60W
Metal Candle Covers</p> | <p>D. 1-424-5-109
5-Light Linear
Chandelier
Polished Nickel Finish
44"L x 16"W x 23-1/2"H
5C 60W
Metal Candle Covers</p> | <p>E. 1-424-5-89
5-Light Linear
Chandelier
Matte Black Finish
44"L x 16"W x 23-1/2"H
5C 60W
Metal Candle Covers</p> |
|-------------------------------------------------------------------------------------------------------------------------------------------------------|-----------------------------------------------------------------------------------------------------------------------------------------------------|----------------------------------------------------------------------------------------------------------------------------------------------------|---------------------------------------------------------------------------------------------------------------------------------------------------------|----------------------------------------------------------------------------------------------------------------------------------------------------|

PALLADIAN

PALLADIAN

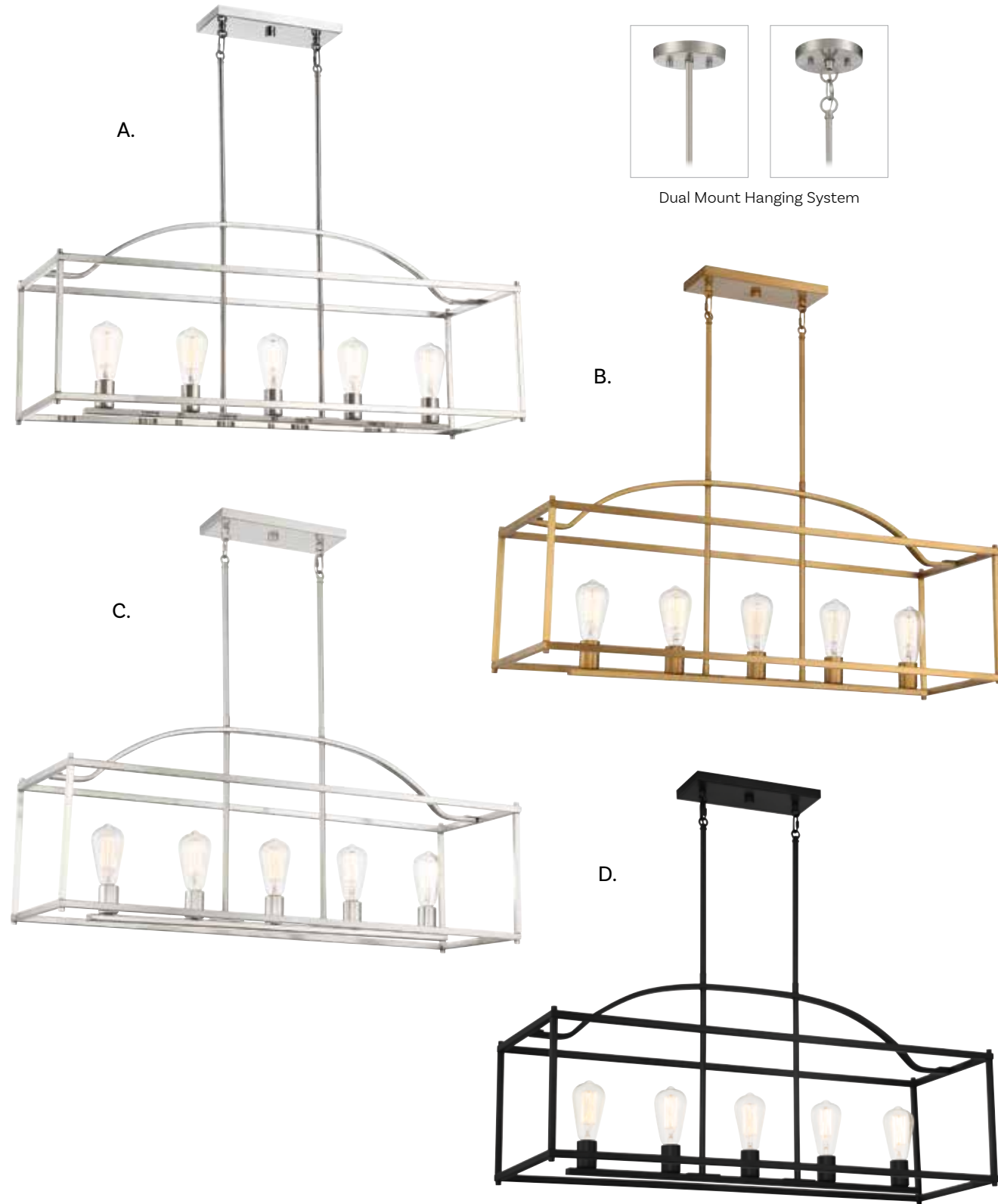

Includes 12" & 6" extensions - additional stems available - 7-EXT



A. 1-190-5-109
5-Light Linear Chandelier
Polished Nickel Finish
38"L x 12"W x 16"H
Adj H 16" - 70"
5E 60W

B. 1-190-5-322
5-Light Linear Chandelier
Warm Brass Finish
38"L x 12"W x 16"H
Adj H 16" - 70"
5E 60W

C. 1-190-5-SN
5-Light Linear Chandelier
Satin Nickel Finish
38"L x 12"W x 16"H
Adj H 16" - 70"
5E 60W

D. 1-190-5-89
5-Light Linear Chandelier
Matte Black Finish
38"L x 12"W x 16"H
Adj H 16" - 70"
5E 60W

A. 1-326-3-322
 3-Light Linear Chandelier
 Warm Brass Finish
 32"L x 12"W x 10-1/2"H
 Adj H 10-1/2" - 65-1/2"
 3E 60W
 30° Swivel



A.

B. 1-326-3-44
 3-Light Linear Chandelier
 Classic Bronze Finish
 32"L x 12"W x 10-1/2"H
 Adj H 10-1/2" - 65-1/2"
 3E 60W
 30° Swivel



B.

C. 1-327-5-322
 5-Light Linear Chandelier
 Warm Brass Finish
 44"L x 12"W x 10-1/2"H
 Adj H 10-1/2" - 65-1/2"
 5E 60W
 30° Swivel



C.

D. 1-327-5-44
 5-Light Linear Chandelier
 Classic Bronze Finish
 44"L x 12"W x 10-1/2"H
 Adj H 10-1/2" - 65-1/2"
 5E 60W
 30° Swivel



D.

Includes 12" & 6" extensions - additional stems available - 7-EXT



Includes 12" & 6" extensions - additional stems available - 7-EXT

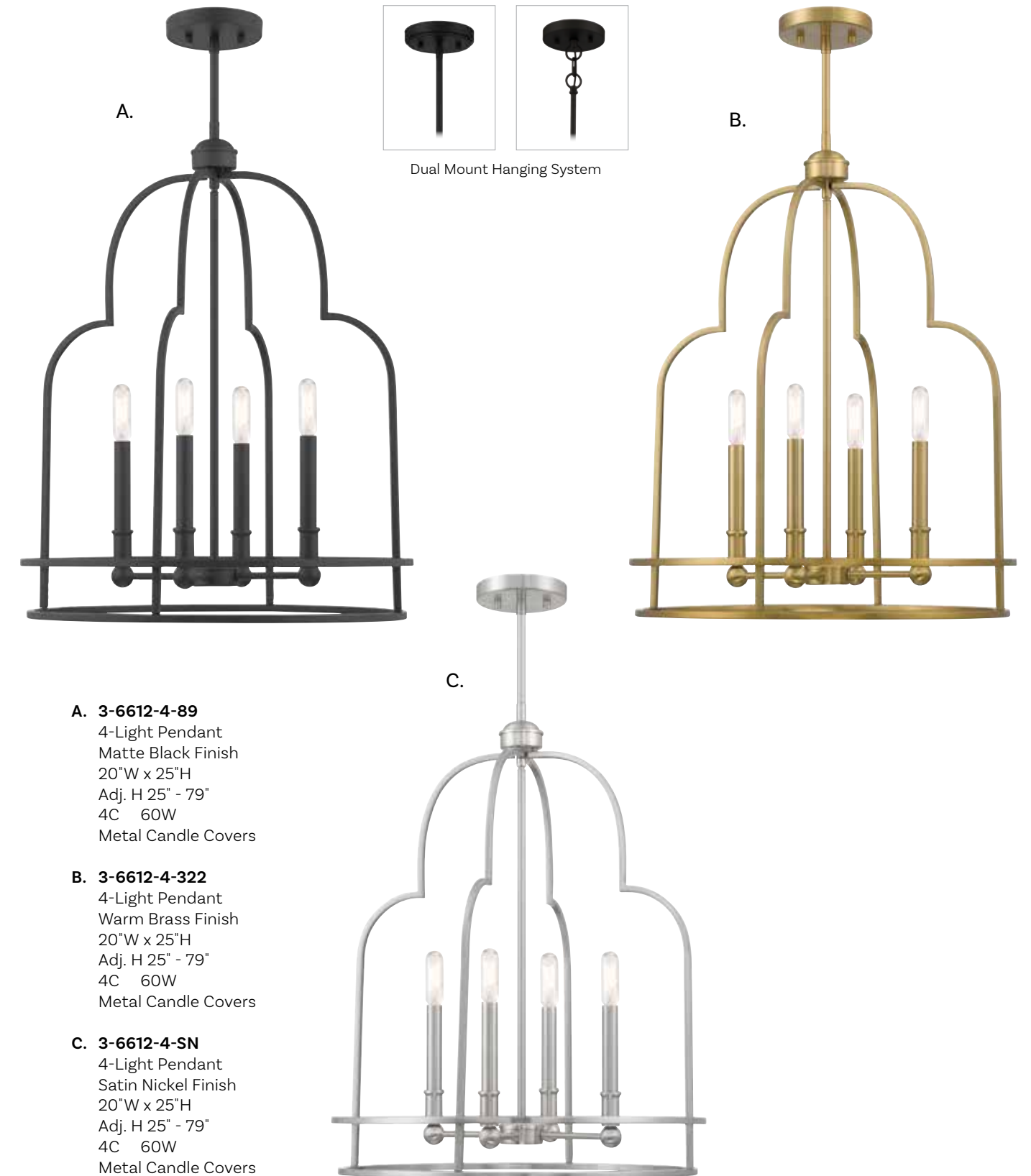



Dual Mount Hanging System

- A. 6-7702-3-89**
3-Light Semi-Flush
Matte Black Finish
13"W x 12"H
3C 60W
Metal Candle Covers
- B. 6-7702-3-322**
3-Light Semi-Flush
Warm Brass Finish
13"W x 12"H
3C 60W
Metal Candle Covers
- C. 6-7702-3-SN**
3-Light Semi-Flush
Satin Nickel Finish
13"W x 12"H
3C 60W
Metal Candle Covers
- D. 3-7700-3-89**
3-Light Pendant
Matte Black Finish
13"W x 16-1/2"H
Adj H 16-1/2" - 70-1/2"
3C 60W
Metal Candle Covers
- E. 3-7700-3-322**
3-Light Pendant
Warm Brass Finish
13"W x 16-1/2"H
Adj H 16-1/2" - 70-1/2"
3C 60W
Metal Candle Covers
- F. 3-7700-3-SN**
3-Light Pendant
Satin Nickel Finish
13"W x 16-1/2"H
Adj H 16-1/2" - 70-1/2"
3C 60W
Metal Candle Covers
- G. 3-7701-5-89**
5-Light Pendant
Matte Black Finish
16"W x 20-1/2"H
Adj H 20-1/2" - 74-1/2"
5C 60W
Metal Candle Covers
- H. 3-7701-5-322**
5-Light Pendant
Warm Brass Finish
16"W x 20-1/2"H
Adj H 20-1/2" - 74-1/2"
5C 60W
Metal Candle Covers
- I. 3-7701-5-SN**
5-Light Pendant
Satin Nickel Finish
16"W x 20-1/2"H
Adj H 20-1/2" - 74-1/2"
5C 60W
Metal Candle Covers



A.



B.



C.



*D.



*E.



*F.



*G.



*H.



*I.

*Includes 12" & 6" extensions - additional stems available - 7-EXT

- A. 6-4900-4-322**
4-Light Semi-Flush
Warm Brass Finish
16"W x 14-3/4"H
4E 60W
Metal Candle Covers
- B. 6-4900-4-89**
4-Light Semi-Flush
Matte Black Finish
16"W x 14-3/4"H
4E 60W
Metal Candle Covers
- C. 6-4900-4-SN**
4-Light Semi-Flush
Satin Nickel Finish
16"W x 14-3/4"H
4E 60W
Metal Candle Covers
- D. 3-4901-4-322**
4-Light Pendant
Warm Brass Finish
16"W x 24"H
Adj H 24" - 81"
4C 60W
30° Swivel
Metal Candle Covers
- E. 3-4901-4-89**
4-Light Pendant
Matte Black Finish
16"W x 24"H
Adj H 24" - 81"
4C 60W
30° Swivel
Metal Candle Covers
- F. 3-4901-4-SN**
4-Light Pendant
Satin Nickel Finish
16"W x 24"H
Adj H 24" - 81"
4C 60W
30° Swivel
Metal Candle Covers



Includes 12" & 6" extensions - additional stems available - 7-EXT

PENROSE



*Includes 120" chain & wire

PENROSE



A.



B.



C.



D.

A. 7-1041-6-109
6-Light Pendant
Polished Nickel Finish
16"W x 34"H
6C 60W
Clear Glass
Metal Candle Covers

B. 7-1041-6-SN
6-Light Pendant
Satin Nickel Finish
16"W x 34"H
6C 60W
Clear Glass
Metal Candle Covers

C. 7-1041-6-BK
6-Light Pendant
Matte Black Finish
16"W x 34"H
6C 60W
Clear Glass
Metal Candle Covers

D. 7-1041-6-13
6-Light Pendant
English Bronze Finish
16"W x 34"H
6C 60W
Clear Glass
Metal Candle Covers

PENROSE

PENROSE



A. 6-1043-3-13
3-Light Semi-Flush
English Bronze Finish
12-1/2"W x 14"H
3C 60W
Clear Glass
Metal Candle Covers

B. 6-1043-3-109
3-Light Semi-Flush
Polished Nickel Finish
12-1/2"W x 14"H
3C 60W
Clear Glass
Metal Candle Covers

C. 6-1043-3-BK
3-Light Semi-Flush
Matte Black Finish
12-1/2"W x 14"H
3C 60W
Clear Glass
Metal Candle Covers

D. 7-1040-3-13
3-Light Pendant
English Bronze Finish
12"W x 26"H
3C 60W
Clear Glass
Metal Candle Covers

E. 7-1040-3-109
3-Light Pendant
Polished Nickel Finish
12"W x 26"H
3C 60W
Clear Glass
Metal Candle Covers

F. 7-1040-3-BK
3-Light Pendant
Matte Black Finish
12"W x 26"H
3C 60W
Clear Glass
Metal Candle Covers

G. 6-1043-3-SN
3-Light Semi-Flush
Satin Nickel Finish
12-1/2"W x 14"H
3C 60W
Clear Glass
Metal Candle Covers

H. 7-1040-3-SN
3-Light Pendant
Satin Nickel Finish
12"W x 26"H
3C 60W
Clear Glass
Metal Candle Covers

*Includes 120" chain & wire

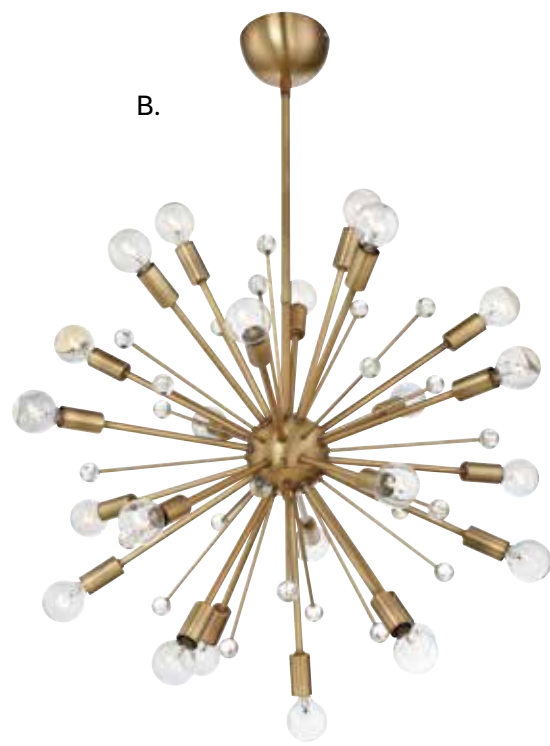

A. 7-6099-24-109
 24-Light Pendant
 Polished Nickel Finish
 23"W x 23"H
 Adj H 23" - 71-1/2"
 24C 25W
 30° Swivel
 K9 Crystal Accents

B. 7-6099-24-322
 24-Light Pendant
 Warm Brass Finish
 23"W x 23"H
 Adj H 23" - 71-1/2"
 24C 25W
 30° Swivel
 K9 Crystal Accents

C. 7-6099-24-89
 24-Light Pendant
 Matte Black Finish
 23"W x 23"H
 Adj H 23" - 71-1/2"
 24C 25W
 30° Swivel
 K9 Crystal Accents



Includes 12" & 6" extensions - additional stems available - 7-EXT



- A. 7-8801-3-109**
3-Light Pendant
Polished Nickel Finish
20"W x 14"H
Adj. H 14" - 68"
3E 60W
Metal Shade
- B. 7-8801-3-322**
3-Light Pendant
Warm Brass Finish
20"W x 14"H
Adj. H 14" - 68"
3E 60W
Metal Shade
- C. 7-8801-3-89**
3-Light Pendant
Matte Black Finish
20"W x 14"H
Adj. H 14" - 68"
3E 60W
Metal Shade



Includes 12" & 6" extensions - additional stems available - 7-EXTLG



Includes (2) sections of 9-1/2" decorative linked stems, plus 120" chain & wire.

- A. 7-232-1-109**
1-Light Pendant
Polished Nickel Finish
12"W x 8-1/2"H
Adj H 8-1/2" - 30"
1E 60W
- B. 7-232-1-323**
1-Light Pendant
Old Bronze Finish
12"W x 8-1/2"H
Adj H 8-1/2" - 30"
1E 60W
- C. 7-231-1-109**
1-Light Pendant
Polished Nickel Finish
18-1/4"W x 12-1/2"H
Adj H 12-1/2" - 33-3/4"
1E 60W
- D. 7-231-1-323**
1-Light Pendant
Old Bronze Finish
18-1/4"W x 12-1/2"H
Adj H 12-1/2" - 33-3/4"
1E 60W
- E. 7-232-1-322**
1-Light Pendant
Warm Brass Finish
12"W x 8-1/2"H
Adj H 8-1/2" - 30"
1E 60W
- F. 7-232-1-89**
1-Light Pendant
Matte Black Finish
12"W x 8-1/2"H
Adj H 8-1/2" - 30"
1E 60W
- G. 7-231-1-322**
1-Light Pendant
Warm Brass Finish
18-1/4"W x 12-1/2"H
Adj H 12-1/2" - 33-3/4"
1E 60W
- H. 7-231-1-89**
1-Light Pendant
Matte Black Finish
18-1/4"W x 12-1/2"H
Adj H 12-1/2" - 33-3/4"
1E 60W





A. 6-3750-1-89
1-Light Semi-Flush
Matte Black Finish
12"W x 12"H
1E 60W

B. 6-3750-1-322
1-Light Semi-Flush
Warm Brass Finish
12"W x 12"H
1E 60W

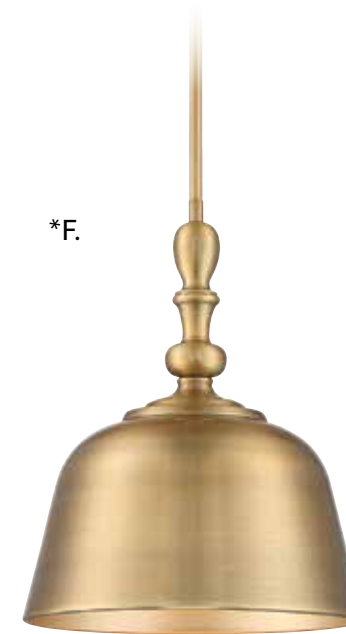
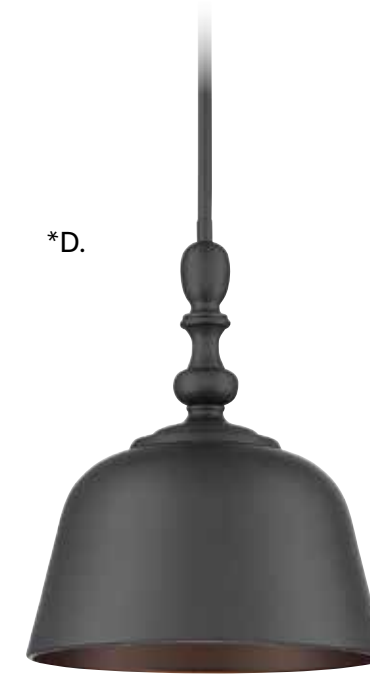
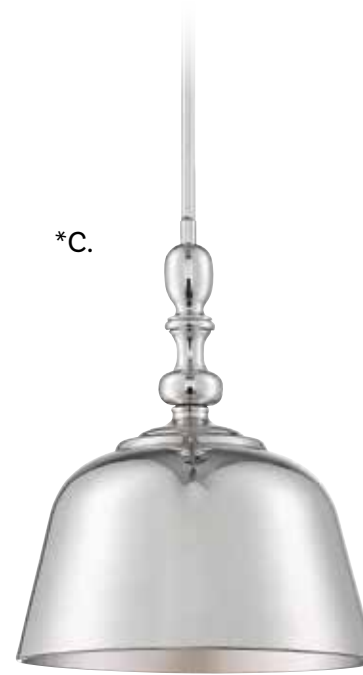

C. 7-3751-1-109
1-Light Pendant
Polished Nickel Finish
12"W x 14"H
Adj H 14" - 45-1/2"
1E 60W
90° Swivel

D. 7-3751-1-89
1-Light Pendant
Matte Black Finish
12"W x 14"H
Adj H 14" - 45-1/2"
1E 60W
90° Swivel

E. 7-3751-1-SN
1-Light Pendant
Satin Nickel Finish
12"W x 14"H
Adj H 14" - 45-1/2"
1E 60W
90° Swivel

F. 7-3751-1-322
1-Light Pendant
Warm Brass Finish
12"W x 14"H
Adj H 14" - 45-1/2"
1E 60W
90° Swivel

G. 7-3751-1-13
1-Light Pendant
English Bronze Finish
12"W x 14"H
Adj H 14" - 45-1/2"
1E 60W
90° Swivel

*Includes 9-1/2" extensions - additional stems available - 7-EXT



Dual Mount Hanging System



- A. 7-4499-1-322**
 1-Light Pendant
 Warm Brass Finish
 14"W x 15-1/2"H
 Adj. H 15-1/2" - 69-1/2"
 1E 60W
 Metal Shade
- B. 7-4499-1-109**
 1-Light Pendant
 Polished Nickel Finish
 14"W x 15-1/2"H
 Adj. H 15-1/2" - 69-1/2"
 1E 60W
 Metal Shade
- C. 7-4499-1-89**
 1-Light Pendant
 Matte Black Finish
 14"W x 15-1/2"H
 Adj. H 15-1/2" - 69-1/2"
 1E 60W
 Metal Shade

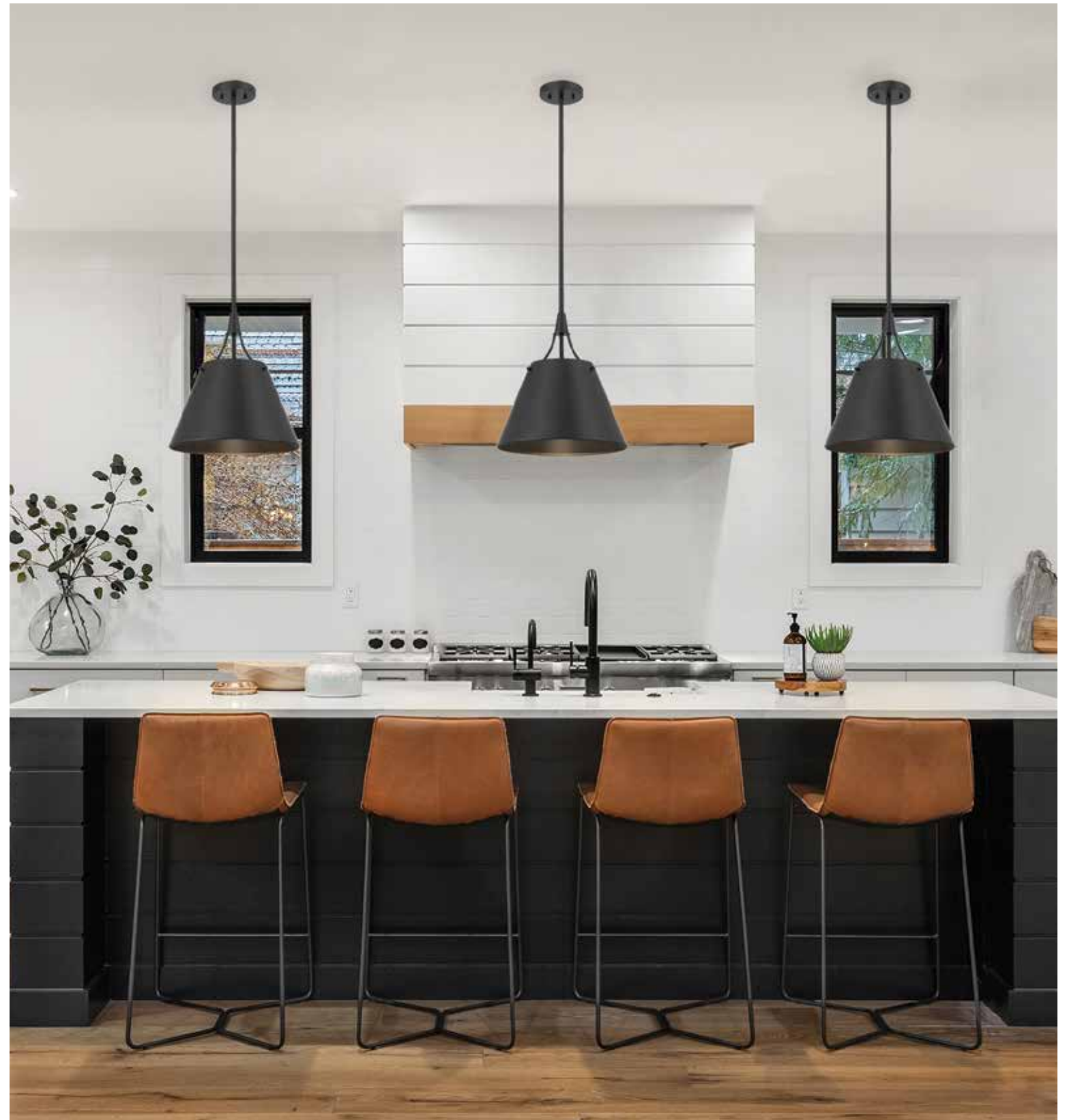

Includes 12" & 6" extensions - additional stems available - 7-EXT



Dual Mount Hanging System

A. 3-1617-4-11
 4-Light Pendant
 Polished Chrome Finish
 14"W x 21"H
 Adj H 21" - 75"
 4C 60W
 Laser Cut Glass

B. 3-1617-4-322
 4-Light Pendant
 Warm Brass Finish
 14"W x 21"H
 Adj H 21" - 75"
 4C 60W
 Laser Cut Glass

C. 3-1617-4-89
 4-Light Pendant
 Matte Black Finish
 14"W x 21"H
 Adj H 21" - 75"
 4C 60W
 Laser Cut Glass



Includes 12" & 6" extensions - additional stems available - 7-EXT



Includes 12" & 6" extensions - additional stems available - **7-EXT**



A. 7-7006-1-89
1-Light Pendant
Matte Black Finish
14"W x 25-1/2"H
1E 60W
Clear Seeded Glass

B. 7-7006-1-322
1-Light Pendant
Warm Brass Finish
14"W x 25-1/2"H
1E 60W
Clear Seeded Glass

C. 7-7006-1-SN
1-Light Pendant
Satin Nickel Finish
14"W x 25-1/2"H
1E 60W
Clear Seeded Glass



Sconce, Page 234

BRANDON



Includes 12" & 6" extensions - additional stems available - **7-EXT**

BRANDON



Dual Mount Hanging System

A. 7-2255-1-322
 1-Light Pendant
 Warm Brass Finish
 14"W x 22"H
 Adj H 22" - 74"
 1E 60W
 30° Swivel
 Clear Fluted Glass

B. 7-2255-1-89
 1-Light Pendant
 Matte Black Finish
 14"W x 22"H
 Adj H 22" - 74"
 1E 60W
 30° Swivel
 Clear Fluted Glass

C. 7-2255-1-SN
 1-Light Pendant
 Satin Nickel Finish
 14"W x 22"H
 Adj H 22" - 74"
 1E 60W
 30° Swivel
 Clear Fluted Glass



Includes 12" & 6" extensions - additional stems available - **7-EXT**



Dual Mount Hanging System

A. 7-2265-1-SN
 1-Light Pendant
 Satin Nickel Finish
 14"W x 20"H
 Adj H 20" - 72"
 1E 60W
 Clear Fluted Glass

B. 7-2265-1-322
 1-Light Pendant
 Warm Brass Finish
 14"W x 20"H
 Adj H 20" - 72"
 1E 60W
 Clear Fluted Glass

C. 7-2265-1-89
 1-Light Pendant
 Matte Black Finish
 14"W x 20"H
 Adj H 20" - 72"
 1E 60W
 Clear Fluted Glass



Includes 12" & 6" extensions - additional stems available - **7-EXT**



Dual Mount Hanging System

A. 7-170-1-11
 1-Light Pendant
 Polished Chrome Finish
 12"W x 14-1/2"H
 Adj H 14-1/2" - 68-1/2"
 1E 60W
 Clear Ribbed Glass

B. 7-170-1-89
 1-Light Pendant
 Matte Black Finish
 12"W x 14-1/2"H
 Adj H 14-1/2" - 68-1/2"
 1E 60W
 Clear Ribbed Glass

C. 7-170-1-322
 1-Light Pendant
 Warm Brass Finish
 12"W x 14-1/2"H
 Adj H 14-1/2" - 68-1/2"
 1E 60W
 Clear Ribbed Glass



A. 7-3901-3-89
3-Light Pendant
Matte Black Finish
13-1/2"W x 31"H
3C 60W

B. 7-3901-3-109
3-Light Pendant
Polished Nickel Finish
13-1/2"W x 31"H
3C 60W

C. 7-3901-3-322
3-Light Pendant
Warm Brass Finish
13-1/2"W x 31"H
3C 60W

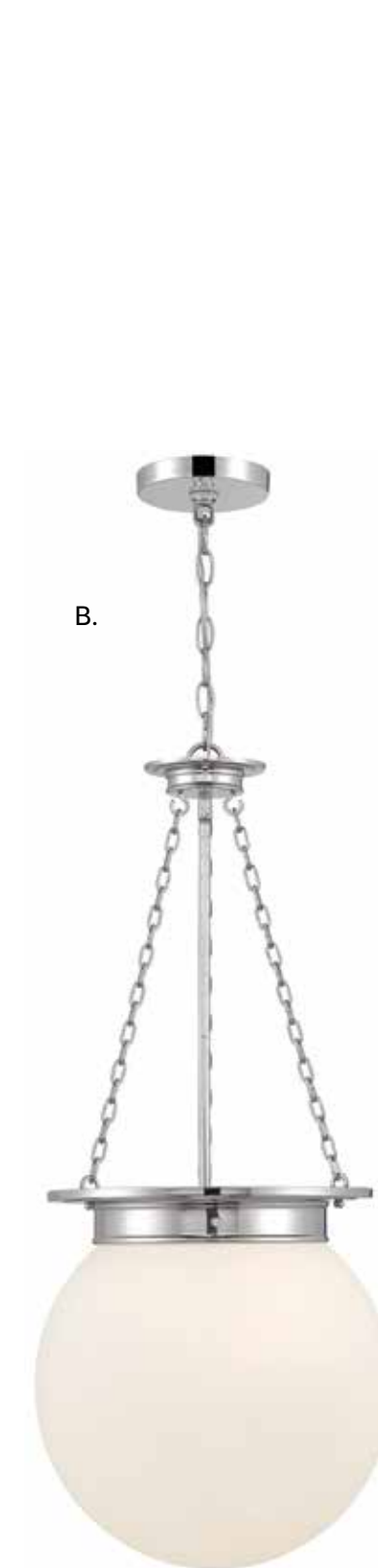

Includes 120" chain & wire



Includes 12" & 6" extensions - additional stems available - **7-EXT**

A.



B.



C.



Dual Mount Hanging System

A. 7-8840-1-89
1-Light Pendant
Matte Black Finish
9"W x 15"H
Adj H 15" - 69"
1E 60W
Fluted White Opal Glass

B. 7-8840-1-SN
1-Light Pendant
Satin Nickel Finish
9"W x 15"H
Adj H 15" - 69"
1E 60W
Fluted White Opal Glass

C. 7-8840-1-322
1-Light Pendant
Warm Brass Finish
9"W x 15"H
Adj H 15" - 69"
1E 60W
Fluted White Opal Glass



Includes 120" chain & wire



A.



C.



B.

A. 7-2201-4-13
4-Light Pendant
English Bronze Finish
18"W x 32-1/2"H
4C 60W
White Fabric Shade

B. 7-2201-4-322
4-Light Pendant
Warm Brass Finish
18"W x 32-1/2"H
4C 60W
White Fabric Shade

C. 7-2201-4-SN
4-Light Pendant
Satin Nickel Finish
18"W x 32-1/2"H
4C 60W
White Fabric Shade



Includes 120" chain & wire



A. 7-1875-3-13
3-Light Pendant
English Bronze Finish
18"W x 21"H
3E 60W
White Fabric Shade

B. 7-1875-3-322
3-Light Pendant
Warm Brass Finish
18"W x 21"H
3E 60W
White Fabric Shade

C. 7-1875-3-89
3-Light Pendant
Matte Black Finish
18"W x 21"H
3E 60W
White Fabric Shade

D. 7-1875-3-11
3-Light Pendant
Polished Chrome Finish
18"W x 21"H
3E 60W
White Fabric Shade



Includes 9-1/2" extensions - additional stems available - **7-EXT**



A. 7-180-1-322
1-Light Pendant
Warm Brass Finish
10"W x 27-1/2"H
Adj H 27-1/2" - 56"
1E 60W
White Glass

B. 7-180-1-SN
1-Light Pendant
Satin Nickel Finish
10"W x 27-1/2"H
Adj H 27-1/2" - 56"
1E 60W
White Glass

C. 7-180-1-109
1-Light Pendant
Polished Nickel Finish
10"W x 27-1/2"H
Adj H 27-1/2" - 56"
1E 60W
White Glass

D. 7-180-1-89
1-Light Pendant
Matte Black Finish
10"W x 27-1/2"H
Adj H 27-1/2" - 56"
1E 60W
White Glass

GARVEY



- A. 7-5012-1-322**
1-Light Pendant
Warm Brass Finish
14"W x 16-1/2"H
Adj H 16-1/2" - 48"
1E 60W
Clear Glass
- B. 7-5012-1-13**
1-Light Pendant
English Bronze Finish
14"W x 16-1/2"H
Adj H 16-1/2" - 48"
1E 60W
Clear Glass
- C. 7-5012-1-109**
1-Light Pendant
Polished Nickel Finish
14"W x 16-1/2"H
Adj H 16-1/2" - 48"
1E 60W
Clear Glass

*Includes 9-1/2" extensions - additional stems available - **7-EXT**

STIRLING/WESTBOURNE



- D. STIRLING 7-200-3-57**
3-Light Pendant
Polished Pewter Finish
12"W x 13"H
Adj H 13"H - 70"
3C 60W
Crackled Glass
Metal Candle Cover
- E. STIRLING 7-200-3-322**
3-Light Pendant
Warm Brass Finish
12"W x 13"H
Adj H 13"H - 70"
3C 60W
Crackled Glass
Metal Candle Covers

Includes 12" & 6" extensions - additional stems available - **7-EXT



- F. WESTBOURNE 7-3102-1-322**
1-Light Pendant
Warm Brass Finish
12-3/4"W x 16-1/2"H
Adj H 16-1/2" - 73-1/2"
1E 60W
White Opal Glass
- G. WESTBOURNE 7-3100-1-322**
1-Light Pendant
Warm Brass Finish
8-3/4"W x 11-1/2"H
Adj H 11-1/2" - 43"
1E 60W
White Opal Glass



Includes 12" & 6" extensions - additional stems available - 7-EXT

BRIAN THOMAS
 COLLECTION



A.



B.

A. 7-9064-1-67
 1-Light Mini-Pendant
 Matte Black w/ Polished
 Chrome Accents
 4-3/4"W x 7"H
 Adj H 7" - 42-1/2"
 1C 60W
 Clear Glass

B. 7-9064-1-95
 1-Light Mini-Pendant
 Warm Brass w/
 Bronze Accents
 4-3/4"W x 7"H
 Adj H 7" - 42-1/2"
 1C 60W
 Clear Glass



C.



D.

C. 7-9063-1-67
 1-Light Pendant
 Matte Black w/ Polished
 Chrome Accents
 12"W x 28-1/2"H
 Adj H 28-1/2" - 85-1/2"
 1E 60W
 Clear Glass

D. 7-9063-1-95
 1-Light Pendant
 Warm Brass w/
 Bronze Accents
 12"W x 28-1/2"H
 Adj H 28-1/2" - 85-1/2"
 1E 60W
 Clear Glass



Includes 120" chain & wire.



A. 7-9006-3-89
3-Light Pendant
Matte Black Finish
12"W x 24"H
3C 60W
Clear Glass
Metal Candle Covers

B. 7-9006-3-SN
3-Light Pendant
Satin Nickel Finish
12"W x 24"H
3C 60W
Clear Glass
Metal Candle Covers

C. 7-9006-3-322
3-Light Pendant
Warm Brass Finish
12"W x 24"H
3C 60W
Clear Glass
Metal Candle Covers

D. 7-9006-3-13
3-Light Pendant
English Bronze Finish
12"W x 24"H
3C 60W
Clear Glass
Metal Candle Covers



- | | | | | |
|-----------------------------------------------------------------------------------------------------------------------------------------------------|------------------------------------------------------------------------------------------------------------------------------------------------|------------------------------------------------------------------------------------------------------------------------------------------------|---------------------------------------------------------------------------------------------------------------------------------------------------|-------------------------------------------------------------------------------------------------------------------------------------------------|
| <p>A. 7-9132-1-109
1-Light Pendant
Polished Nickel Finish
10"W x 10-1/4"H
Adj H 10-1/4" - 43"
1E 60W
Clear Glass</p> | <p>B. 7-9132-1-89
1-Light Pendant
Matte Black Finish
10"W x 10-1/4"H
Adj H 10-1/4" - 43"
1E 60W
Clear Glass</p> | <p>C. 7-9132-1-322
1-Light Pendant
Warm Brass Finish
10"W x 10-1/4"H
Adj H 10-1/4" - 43"
1E 60W
Clear Glass</p> | <p>D. 7-9132-1-13
1-Light Pendant
English Bronze Finish
10"W x 10-1/4"H
Adj H 10-1/4" - 43"
1E 60W
Clear Glass</p> | <p>E. 7-9132-1-SN
1-Light Pendant
Satin Nickel Finish
10"W x 10-1/4"H
Adj H 10-1/4" - 43"
1E 60W
Clear Glass</p> |
|-----------------------------------------------------------------------------------------------------------------------------------------------------|------------------------------------------------------------------------------------------------------------------------------------------------|------------------------------------------------------------------------------------------------------------------------------------------------|---------------------------------------------------------------------------------------------------------------------------------------------------|-------------------------------------------------------------------------------------------------------------------------------------------------|



Includes 9-1/2" extensions - additional stems available - **7-EXT**

CHANTILLY



- A. 7-1742-1-322**
1-Light Pendant
Warm Brass Finish
8"W x 13"H
Adj H 13" - 41-1/2"
1E 60W
Clear Ribbed Glass
- B. 7-1742-1-89**
1-Light Pendant
Matte Black Finish
8"W x 13"H
Adj H 13" - 41-1/2"
1E 60W
Clear Ribbed Glass
- C. 7-1742-1-109**
1-Light Pendant
Polished Nickel Finish
8"W x 13"H
Adj H 13" - 41-1/2"
1E 60W
Clear Ribbed Glass

Includes 9-1/2" extensions - additional stems available - **7-EXT**



LAKEWOOD



- D. 7-1831-1-322**
1-Light Pendant
Warm Brass Finish
8"W x 22"H
Adj H 22" - 50-1/2"
1E 60W
Clear Glass
- E. 7-1831-1-89**
1-Light Pendant
Matte Black Finish
8"W x 22"H
Adj H 22" - 50-1/2"
1E 60W
Clear Glass

PENDLETON



*Includes 9-1/2" extensions - additional stems available - 7-EXT

PENDLETON



A.

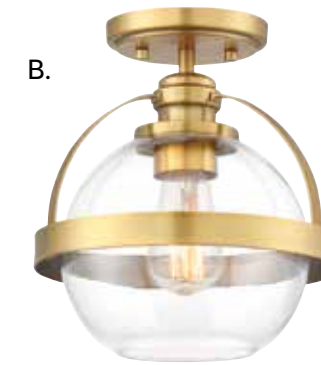

B.



C.



*D



*E.

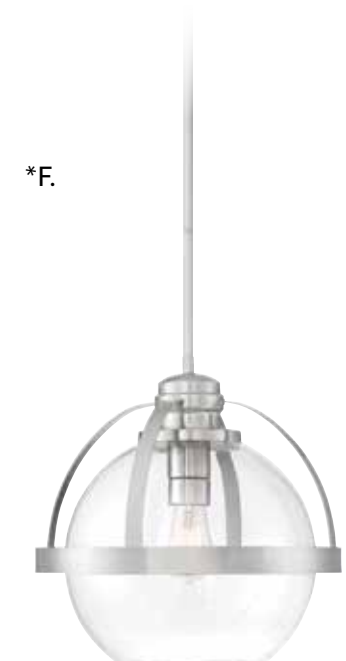

*F.

- | | | | | | |
|-----------------------|------------------------|-----------------------|-----------------------|------------------------|-----------------------|
| A. 6-7200-1-89 | B. 6-7200-1-322 | C. 6-7200-1-SN | D. 7-7201-1-89 | E. 7-7201-1-322 | F. 7-7201-1-SN |
| 1-Light Semi-Flush | 1-Light Semi-Flush | 1-Light Semi-Flush | 1-Light Pendant | 1-Light Pendant | 1-Light Pendant |
| Matte Black Finish | Warm Brass Finish | Satin Nickel Finish | Matte Black Finish | Warm Brass Finish | Satin Nickel Finish |
| 9-3/8"W x 9-3/4"H | 9-3/8"W x 9-3/4"H | 9-3/8"W x 9-3/4"H | 14"W x 14"H | 14"W x 14"H | 14"W x 14"H |
| 1E 60W | 1E 60W | 1E 60W | Adj H 14"- 45-1/2" | Adj H 14"- 45-1/2" | Adj H 14"- 45-1/2" |
| Clear Glass | Clear Glass | Clear Glass | 1E 60W | 1E 60W | 1E 60W |
| | | | Clear Glass | Clear Glass | Clear Glass |

WRIGHT / CARLTON



*Includes 12" & 6" extensions - additional stems available - 7-EXT

**Includes 9-1/2" extensions - additional stems available - 7-EXT

WRIGHT / CARLTON



Dual Mount Hanging System

A. CARLTON
7-3390-1-322
 1-Light Pendant
 Warm Brass Finish
 11"W x 20"H
 Adj H 20" - 74"
 1E 60W
 Ribbed Glass

B. CARLTON
7-3390-1-89
 1-Light Pendant
 Matte Black Finish
 11"W x 20"H
 Adj H 20" - 74"
 1E 60W
 Ribbed Glass

C. WRIGHT
7-3075-1-89
 1-Light Mini-Pendant
 Matte Black Finish
 5-3/4"W x 9-3/4"H
 Adj H 9-3/4" - 38-1/4"
 1E 60W
 Clear Glass

D. WRIGHT
7-3075-1-11
 1-Light Mini-Pendant
 Polished Chrome Finish
 5-3/4"W x 9-3/4"H
 Adj H 9-3/4" - 38-1/4"
 1E 60W
 Clear Glass

E. WRIGHT
7-3075-1-322
 1-Light Mini-Pendant
 Warm Brass Finish
 5-3/4"W x 9-3/4"H
 Adj H 9-3/4" - 38-1/4"
 1E 60W
 Clear Glass

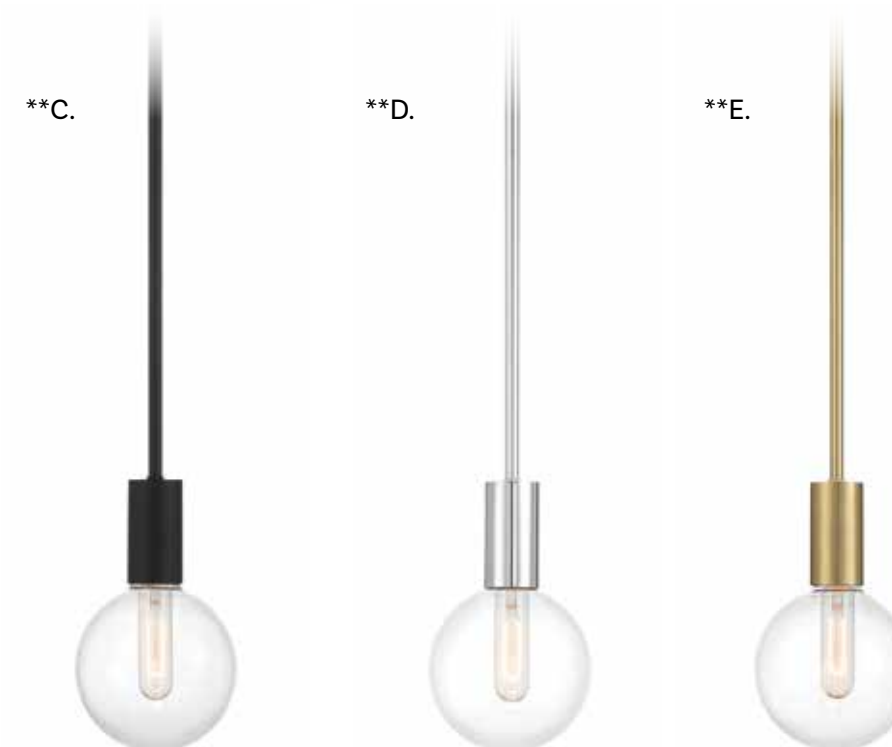



Includes 9-1/2" extensions - additional stems available - **7-EXT**



Dual Mount Hanging System

- A. 7-1026-1-SN**
1-Light Mini-Pendant
Satin Nickel Finish
5"W x 7"H
Adj H 7" - 37"
1E 60W
Clear Glass
- B. 7-1026-1-89**
1-Light Mini-Pendant
Matte Black Finish
5"W x 7"H
Adj H 7" - 37"
1E 60W
Clear Glass
- C. 7-1026-1-322**
1-Light Mini-Pendant
Warm Brass Finish
5"W x 7"H
Adj H 7" - 37"
1E 60W
Clear Glass
- D. 7-1027-1-SN**
1-Light Pendant
Satin Nickel Finish
8"W x 11"H
Adj H 11" - 63"
1E 60W
Clear Glass
- E. 7-1027-1-89**
1-Light Pendant
Matte Black Finish
8"W x 11"H
Adj H 11" - 63"
1E 60W
Clear Glass
- F. 7-1027-1-322**
1-Light Pendant
Warm Brass Finish
8"W x 11"H
Adj H 11" - 63"
1E 60W
Clear Glass



ASHMONT



PENDANTS



A. 7-130-1-63
1-Light Pendant
Warm Brass Lustre Finish
13"W x 21-1/4"H
Adj H 21-1/4" - 49-3/4"
1E 60W
White Opal Glass



B. 7-130-1-SN
1-Light Pendant
Satin Nickel Finish
13"W x 21-1/4"H
Adj H 21-1/4" - 49-3/4"
1E 60W
White Opal Glass



C. 7-130-1-44
1-Light Pendant
Classic Bronze Finish
13"W x 21-1/4"H
Adj H 21-1/4" - 49-3/4"
1E 60W
White Opal Glass



D. HERNDON
7-1010-1-SN
1-Light Mini-Pendant
Satin Nickel Finish
5-1/2"W x 9-1/2"H
Adj H 9-1/2" - 38"
1E 60W
Frosted White Glass



E. VINTAGE
7-4134-1-13
1-Light Mini-Pendant
English Bronze Finish
7"W x 10-1/2"H
Adj H 10-1/2" - 42"
1E 60W
Clear Glass



F. VINTAGE
7-4134-1-SN
1-Light Mini-Pendant
Satin Nickel Finish
7"W x 10-1/2"H
Adj H 10-1/2" - 42"
1E 60W
Clear Glass



G. CHIVAL
7-730-1-109
1-Light Pendant
Polished Nickel Finish
11"W x 17"H
Adj H 17" - 48-1/2"
1E 60W
White Opal Etched Glass

Includes 9-1/2" extensions - additional stems available - **7-EXT**



- A. FRANKLIN 7-702-1-13**
1-Light Pendant
English Bronze Finish
10"W x 20"H
1E 60W
Clear Glass
- B. FRANKLIN 7-703-1-SN**
1-Light Pendant
Satin Nickel Finish
10"W x 20"H
1E 60W
Silver Mercury Glass
- C. FRANKLIN 7-702-1-109**
1-Light Pendant
Polished Nickel Finish
10"W x 20"H
1E 60W
Clear Glass
- D. BALLY 7-700-1-109**
1-Light Pendant
Polished Nickel Finish
6-1/2"W x 12"H
1E 60W
Clear Glass
- E. BALLY 7-701-1-SN**
1-Light Pendant
Satin Nickel Finish
6-1/2"W x 12"H
1E 60W
Silver Mercury Glass

Includes 120" chain & wire.



- F. 7-4036-1-SN**
1-Light Pendant
Satin Nickel Finish
8"W x 10-1/2H
Adj H 10-1/2" - 42"
1E 60W
Clear Glass
- G. 7-4036-1-BK**
1-Light Pendant
Matte Black Finish
8"W x 10-1/2H
Adj H 10-1/2" - 42"
1E 60W
Clear Glass
- H. 7-4036-1-11**
1-Light Pendant
Polished Chrome Finish
8"W x 10-1/2H
Adj H 10-1/2" - 42"
1E 60W
Clear Glass
- I. 7-4036-1-322**
1-Light Pendant
Warm Brass Finish
8"W x 10-1/2H
Adj H 10-1/2" - 42"
1E 60W
Clear Glass
- J. 7-4036-1-13**
1-Light Pendant
English Bronze Finish
8"W x 10-1/2H
Adj H 10-1/2" - 42"
1E 60W
Clear Glass

Includes 9-1/2" extensions - additional stems available - 7-EXT



A. 6-1953-4-322
4-Light Ceiling Light
Warm Brass Finish
20"W x 13-1/2"H
4E 60W
White Fabric Shade

B. 6-1953-4-89
4-Light Ceiling Light
Matte Black Finish
20"W x 13-1/2"H
4E 60W
White Fabric Shade

C. 6-1953-4-109
4-Light Ceiling Light
Polished Nickel Finish
20"W x 13-1/2"H
4E 60W
White Fabric Shade



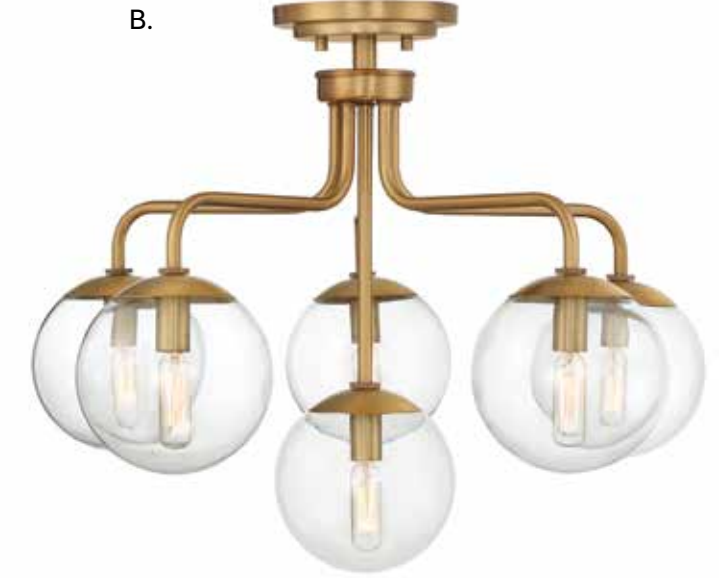

A. 6-1950-6-322
6-Light Semi-Flush
Warm Brass Finish
24"W x 18-1/4"H
6C 60W
White Opal Glass

B. 6-1951-6-322
6-Light Semi-Flush
Warm Brass Finish
24"W x 18-1/4"H
6C 60W
Clear Glass

C. 6-1950-6-89
6-Light Semi-Flush
Matte Black Finish
24"W x 18-1/4"H
6C 60W
White Opal Glass





A. 6-1679-5-SN
5-Light Semi-Flush
Satin Nickel Finish
24"W x 12"H
5C 60W

B. 6-1679-5-322
5-Light Semi-Flush
Warm Brass Finish
24"W x 12"H
5C 60W

C. 6-1679-5-89
5-Light Semi-Flush
Matte Black Finish
24"W x 12"H
5C 60W

LYRIQUE



LYRIQUE

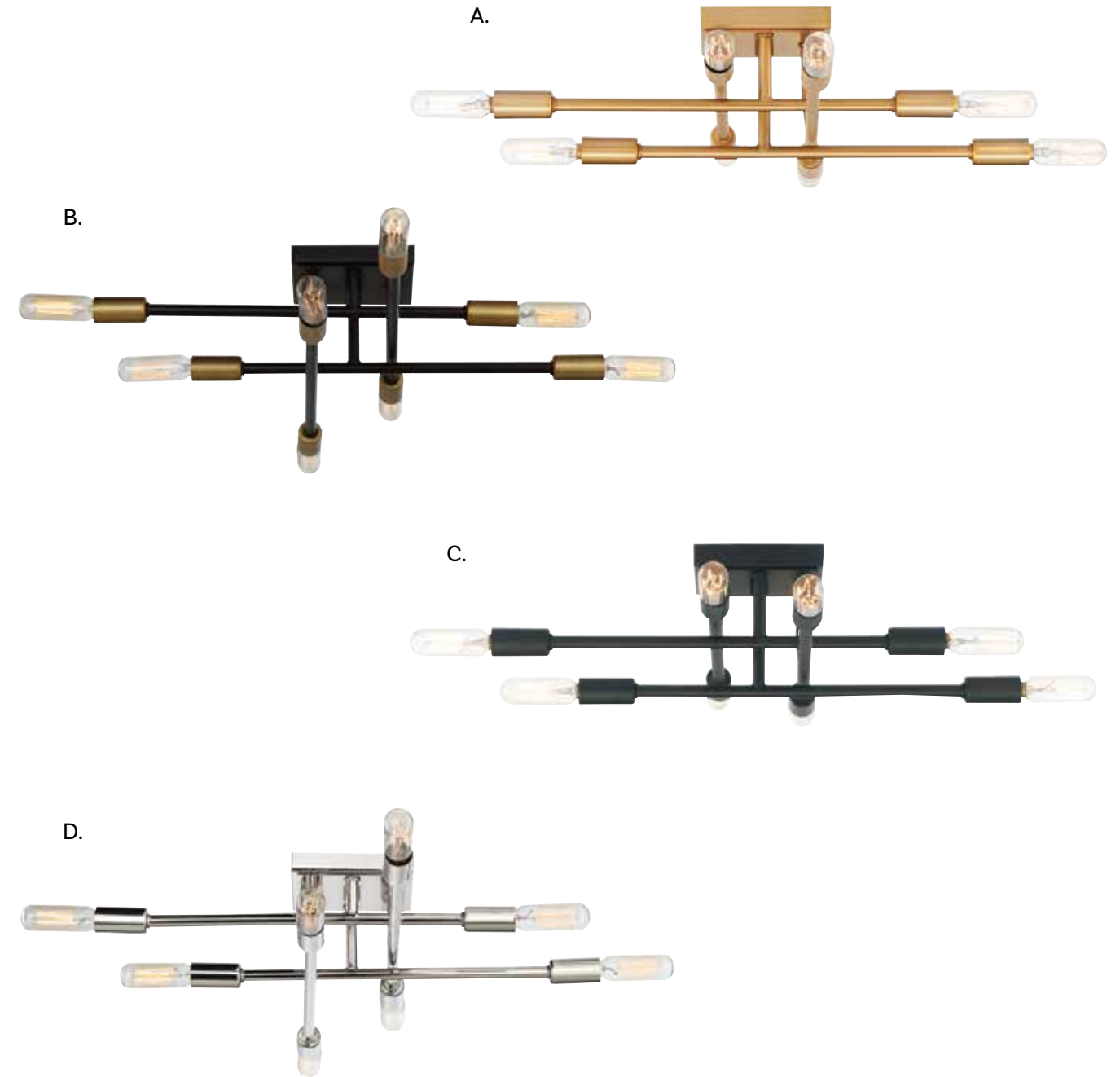

A. 6-7003-8-322
8-Light Flush Mount
Warm Brass Finish
19-1/2"L x 19-1/2"W x 4-3/4"H
8C 60W

B. 6-7003-8-77
8-Light Flush Mount
Bronze w/ Brass Accents
19-1/2"L x 19-1/2"W x 4-3/4"H
8C 60W

C. 6-7003-8-89
8-Light Flush Mount
Matte Black Finish
19-1/2"L x 19-1/2"W x 4-3/4"H
8C 60W

D. 6-7003-8-109
8-Light Flush Mount
Polished Nickel Finish
19-1/2"L x 19-1/2"W x 4-3/4"H
8C 60W



A. 6-134-3-322
 3-Light Semi-Flush
 Warm Brass Finish
 16"W x 9-1/4"H
 3E 60W
 White Opal Glass

B. 6-134-3-44
 3-Light Semi-Flush
 Classic Bronze Finish
 16"W x 9-1/4"H
 3E 60W
 White Opal Glass

C. 6-134-3-109
 3-Light Semi-Flush
 Polished Nickel Finish
 16"W x 9-1/4"H
 3E 60W
 White Opal Glass

D. 6-133-16-322
 3-Light Flush Mount
 Warm Brass Finish
 16"W x 4"H
 3E 60W
 White Opal Glass

E. 6-133-16-44
 3-Light Flush Mount
 Classic Bronze Finish
 16"W x 4"H
 3E 60W
 White Opal Glass

F. 6-133-16-109
 3-Light Flush Mount
 Polished Nickel Finish
 16"W x 4"H
 3E 60W
 White Opal Glass





A.



B.



C.



D.



E.



F.



G.



H.

A. 6-3350-16-109
3-Light Flush Mount
Polished Nickel Finish
15"W x 4-3/4"H
3E 60W
White Glass

B. 6-3350-14-109
2-Light Flush Mount
Polished Nickel Finish
13-1/4"W x 4-3/4"H
2E 60W
White Glass

C. 6-3350-16-13
3-Light Flush Mount
English Bronze Finish
15"W x 4-3/4"H
3E 60W
White Glass

D. 6-3350-14-13
2-Light Flush Mount
English Bronze Finish
13-1/4"W x 4-3/4"H
2E 60W
White Glass

E. 6-3350-16-322
3-Light Flush Mount
Warm Brass Finish
15"W x 4-3/4"H
3E 60W
White Glass

F. 6-3350-14-322
2-Light Flush Mount
Warm Brass Finish
13-1/4"W x 4-3/4"H
2E 60W
White Glass

G. 6-3350-16-SN
3-Light Flush Mount
Satin Nickel Finish
15"W x 4-3/4"H
3E 60W
White Glass

H. 6-3350-14-SN
2-Light Flush Mount
Satin Nickel Finish
13-1/4"W x 4-3/4"H
2E 60W
White Glass

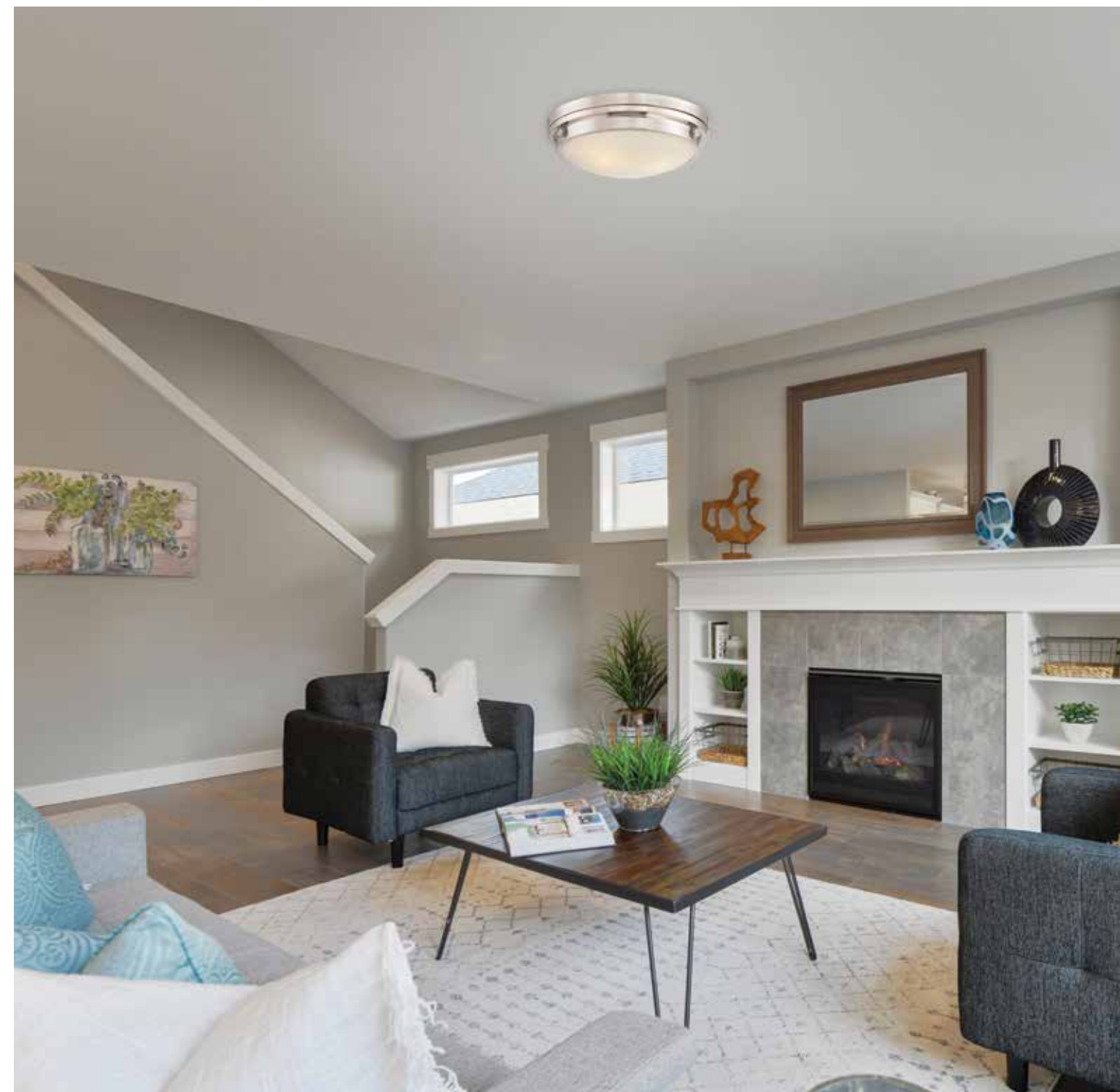

OCTAVE



A.

- A. 6-4037-1-SN**
1-Light Semi-Flush
Satin Nickel Finish
6"W x 13-1/2"H
1E 60W
Clear Glass
- B. 6-4037-1-BK**
1-Light Semi-Flush
Matte Black Finish
6"W x 13-1/2"H
1E 60W
Clear Glass
- C. 6-4037-1-11**
1-Light Semi-Flush
Polished Chrome Finish
6"W x 13-1/2"H
1E 60W
Clear Glass



B.

- D. 6-4037-1-322**
1-Light Semi-Flush
Warm Brass Finish
6"W x 13-1/2"H
1E 60W
Clear Glass
- E. 6-4037-1-13**
1-Light Semi-Flush
English Bronze Finish
6"W x 13-1/2"H
1E 60W
Clear Glass



C.



D.



E.



OCTAVE

- F. 6-4035-3-SN**
3-Light Semi-Flush
Satin Nickel Finish
13"W x 11"H
3E 60W
Clear Glass
- G. 6-4035-3-BK**
3-Light Semi-Flush
Matte Black Finish
13"W x 11"H
3E 60W
Clear Glass
- H. 6-4035-3-11**
3-Light Semi-Flush
Polished Chrome
Finish
13"W x 11"H
3E 60W
Clear Glass
- I. 6-4035-3-13**
3-Light Semi-Flush
English Bronze Finish
13"W x 11"H
3E 60W
Clear Glass
- J. 6-4035-3-322**
3-Light Semi-Flush
Warm Brass Finish
13"W x 11"H
3E 60W
Clear Glass



F.



G.



H.



I.



J.



A. 6-7790-3-322
 3-Light Semi-Flush
 Warm Brass Finish
 11-3/8"W x 12-1/4"H
 3C 60W
 Cracked Glass
 Metal Candle Covers

B. 6-7790-3-SN
 3-Light Semi-Flush
 Satin Nickel Finish
 11-3/8"W x 12-1/4"H
 3C 60W
 Cracked Glass
 Metal Candle Covers

C. 6-7790-3-89
 3-Light Semi-Flush
 Matte Black Finish
 11-3/8"W x 12-1/4"H
 3C 60W
 Cracked Glass
 Metal Candle Covers

KENT



A.

A. 6-4900-4-89
4-Light Semi-Flush
Matte Black Finish
16"W x 14-3/4"H
4E 60W
Metal Candle Covers



B.

B. 6-4900-4-322
4-Light Semi-Flush
Warm Brass Finish
16"W x 14-3/4"H
4E 60W
Metal Candle Covers



C.

C. 6-4900-4-SN
4-Light Semi-Flush
Satin Nickel Finish
16"W x 14-3/4"H
4E 60W
Metal Candle Covers

BENSON



D.

D. 6-7702-3-89
3-Light Semi-Flush
Matte Black Finish
13"W x 12"H
3C 60W
Metal Candle Covers



E.

E. 6-7702-3-322
3-Light Semi-Flush
Warm Brass Finish
13"W x 12"H
3C 60W
Metal Candle Covers



F.

F. 6-7702-3-SN
3-Light Semi-Flush
Satin Nickel Finish
13"W x 12"H
3C 60W
Metal Candle Covers



Pendant, Page 129

CALHOUN / PENROSE

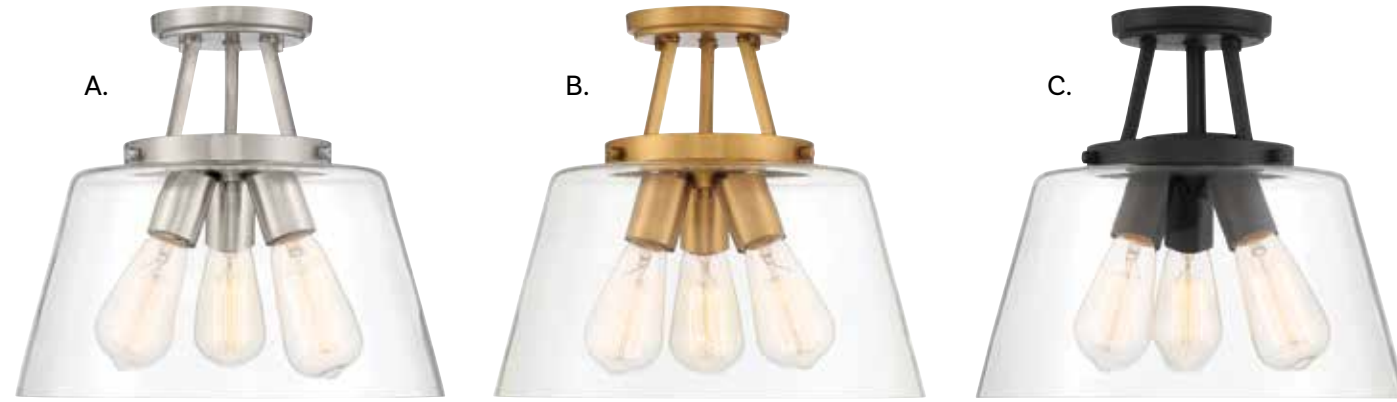

A.

B.

C.



D.



E.



F.

- A. CALHOUN**
6-1024-3-SN
3-Light Semi-Flush
Satin Nickel Finish
13"W x 11-1/2"H
3E 60W
Clear Glass
- B. CALHOUN**
6-1024-3-322
3-Light Semi-Flush
Warm Brass Finish
13"W x 11-1/2"H
3E 60W
Clear Glass
- C. CALHOUN**
6-1024-3-89
3-Light Semi-Flush
Matte Black Finish
13"W x 11-1/2"H
3E 60W
Clear Glass
- D. PENROSE**
6-1043-3-109
3-Light Semi-Flush
Polished Nickel
Finish
12-1/2"W x 14"H
3C 60W
Clear Glass
Metal Candle
Covers
- E. PENROSE**
6-1043-3-13
3-Light Semi-Flush
English Bronze
Finish
12-1/2"W x 14"H
3C 60W
Clear Glass
Metal Candle
Covers
- F. PENROSE**
6-1043-3-SN
3-Light Semi-Flush
Satin Nickel
Finish
12-1/2"W x 14"H
3C 60W
Clear Glass
Metal Candle
Covers

PENDLETON / BERG



G.

H.

I.



J.



K.

- G. PENDLETON**
6-7200-1-322
1-Light Semi-Flush
Warm Brass Finish
9-3/8"W x 9-3/4"H
1E 60W
Clear Glass
- H. PENDLETON**
6-7200-1-SN
1-Light Semi-Flush
Satin Nickel Finish
9-3/8"W x 9-3/4"H
1E 60W
Clear Glass
- I. PENDLETON**
6-7200-1-89
1-Light Semi-Flush
Matte Black Finish
9-3/8"W x 9-3/4"H
1E 60W
Clear Glass
- J. BERG**
6-3750-1-322
1-Light Semi-Flush
Warm Brass Finish
12"W x 12"H
1E 60W
- K. BERG**
6-3750-1-89
1-Light Semi-Flush
Matte Black Finish
12"W x 12"H
1E 60W

CEILING



A.

A. MELROSE
6-6835-2-13
 2-Light Semi-Flush
 English Bronze Finish
 14"W x 11-1/2"H
 2E 60W
 White Opal Etched Glass



B.

B. MELROSE
6-6835-2-SN
 2-Light Semi-Flush
 Satin Nickel Finish
 14"W x 11-1/2"H
 2E 60W
 White Opal Etched Glass

CEILING



C.



D.



E.



F.



G.



H.



I.



J.

C. 6-780-13-BK
 2-Light Flush Mount
 Matte Black Finish
 13"W x 5"H
 2E 60W
 White Etched Glass

D. 6-780-11-BK
 2-Light Flush Mount
 Matte Black Finish
 11"W x 4-1/2"H
 2E 40W
 White Etched Glass

E. 6-780-13-SN
 2-Light Flush Mount
 Satin Nickel Finish
 13"W x 5"H
 2E 60W
 White Etched Glass

F. 6-780-11-SN
 2-Light Flush Mount
 Satin Nickel Finish
 11"W x 4-1/2"H
 2E 40W
 White Etched Glass

G. 6-780-13-322
 2-Light Flush Mount
 Warm Brass Finish
 13"W x 5"H
 2E 60W
 White Etched Glass

H. 6-780-11-322
 2-Light Flush Mount
 Warm Brass Finish
 11"W x 4-1/2"H
 2E 40W
 White Etched Glass

I. 6-780-13-13
 2-Light Flush Mount
 English Bronze Finish
 13"W x 5"H
 2E 60W
 White Etched Glass

J. 6-780-11-13
 2-Light Flush Mount
 English Bronze Finish
 11"W x 4-1/2"H
 2E 40W
 White Etched Glass



A.

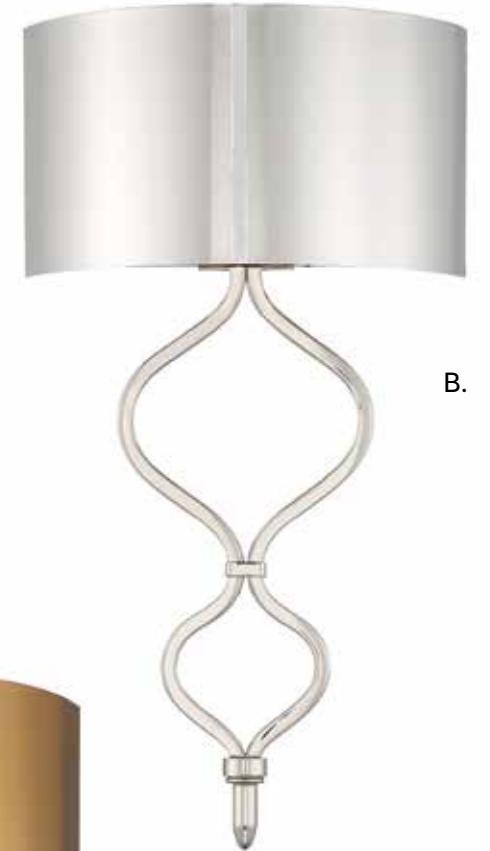

B.

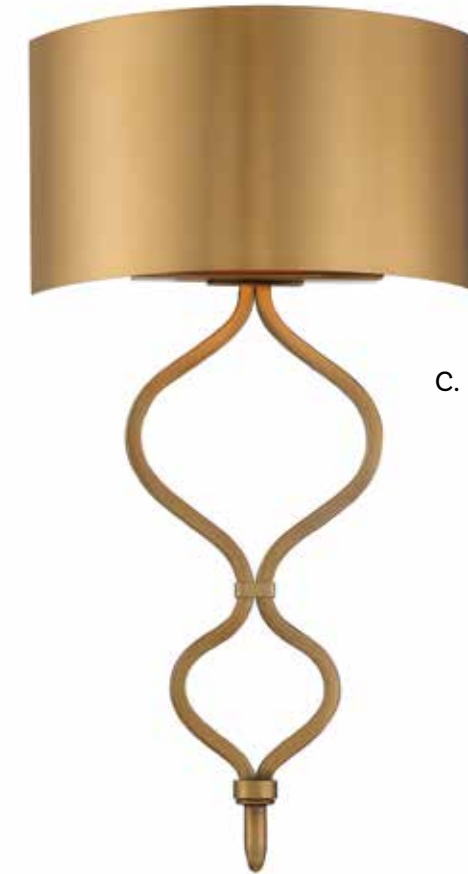

C.

- A. 9-6520-1-89**
LED Sconce
Matte Black Finish
11"W x 20"H x 4"E
14W Dimmable LED
300 Lumens, 3000K, 90+ CRI
- B. 9-6520-1-109**
LED Sconce
Polished Nickel Finish
11"W x 20"H x 4"E
14W Dimmable LED
300 Lumens, 3000K, 90+ CRI
- C. 9-6520-1-322**
LED Sconce
Warm Brass Finish
11"W x 20"H x 4"E
14W Dimmable LED
300 Lumens, 3000K, 90+ CRI



JOFFREE



A. 9-1914-1-322
1-Light Sconce
Warm Brass Finish
5"W x 20-3/8"H x 6-1/2"E
1C 60W
White Fabric Shade

B. 9-1914-1-89
1-Light Sconce
Matte Black Finish
5"W x 20-3/8"H x 6-1/2"E
1C 60W
White Fabric Shade



A.



B.

POLSON



C. 9-1911-1-322
1-Light Sconce
Warm Brass Finish
8"W x 15-1/2"H x 8"E
1E 60W
Opal Etched Glass

D. 9-1911-1-89
1-Light Sconce
Matte Black Finish
8"W x 15-1/2"H x 8"E
1E 60W
Opal Etched Glass

E. 9-1911-1-11
1-Light Sconce
Polished Chrome Finish
8"W x 15-1/2"H x 8"E
1E 60W
Opal Etched Glass



C.



D.



E.

RHODES

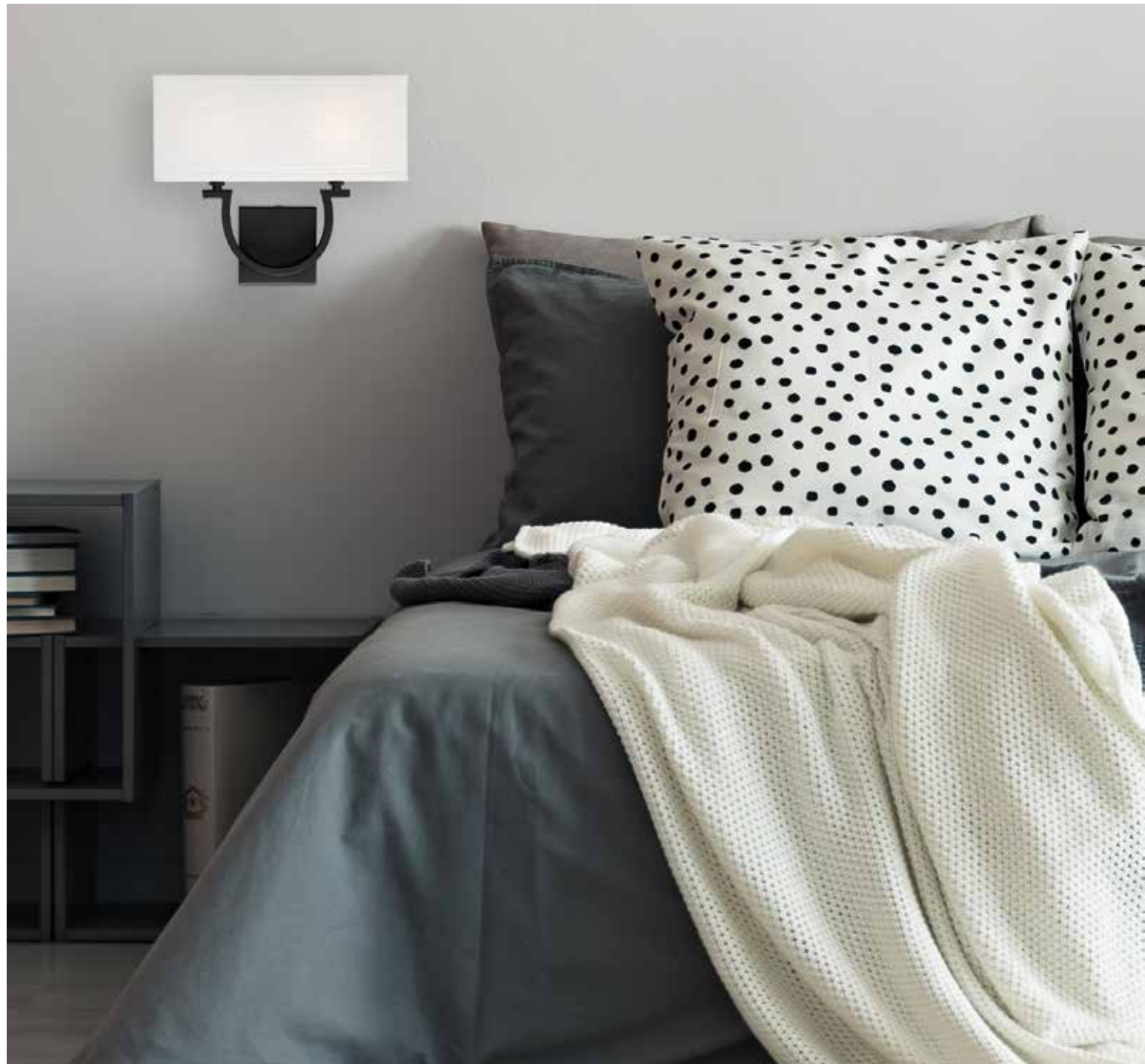

- | | | | | |
|-------------------------------------------------------------------------------------------------------------------------------------------------------|---------------------------------------------------------------------------------------------------------------------------------------------------------|-----------------------------------------------------------------------------------------------------------------------------------------------------------|------------------------------------------------------------------------------------------------------------------------------------------------------|------------------------------------------------------------------------------------------------------------------------------------------------------|
| <p>A. 9-998-2-SN
2-Light Sconce
Satin Nickel Finish
14"W x 12"H x 4"E
2C 60W
White Linen Shade
Metal Candle Covers</p> | <p>B. 9-998-2-44
2-Light Sconce
Classic Bronze Finish
14"W x 12"H x 4"E
2C 60W
White Linen Shade
Metal Candle Covers</p> | <p>C. 9-998-2-109
2-Light Sconce
Polished Nickel Finish
14"W x 12"H x 4"E
2C 60W
White Linen Shade
Metal Candle Covers</p> | <p>D. 9-998-2-89
2-Light Sconce
Matte Black Finish
14"W x 12"H x 4"E
2C 60W
White Linen Shade
Metal Candle Covers</p> | <p>E. 9-998-2-322
2-Light Sconce
Warm Brass Finish
14"W x 12"H x 4"E
2C 60W
White Linen Shade
Metal Candle Covers</p> |
|-------------------------------------------------------------------------------------------------------------------------------------------------------|---------------------------------------------------------------------------------------------------------------------------------------------------------|-----------------------------------------------------------------------------------------------------------------------------------------------------------|------------------------------------------------------------------------------------------------------------------------------------------------------|------------------------------------------------------------------------------------------------------------------------------------------------------|

RHODES





- | | | | | | |
|-----------------------------------------------------------------------------------------------------------------|----------------------------------------------------------------------------------------------------------------|----------------------------------------------------------------------------------------------------------------|--------------------------------------------------------------------------------------------------------------|-------------------------------------------------------------------------------------------------------------|-------------------------------------------------------------------------------------------------------------|
| A. 9-5201-1-83
1-Light Sconce
Bisque White Finish
5-1/2"W x 20"H x 7"E
1C 60W
Metal Shade | B. 9-5201-1-89
1-Light Sconce
Matte Black Finish
5-1/2"W x 20"H x 7"E
1C 60W
Metal Shade | C. 9-5201-1-322
1-Light Sconce
Warm Brass Finish
5-1/2"W x 20"H x 7"E
1C 60W
Metal Shade | D. 9-5202-2-83
2-Light Sconce
Bisque White Finish
16"W x 20"H x 7"E
2C 60W
Metal Shade | E. 9-5202-2-89
2-Light Sconce
Matte Black Finish
16"W x 20"H x 7"E
2C 60W
Metal Shade | F. 9-5202-2-322
2-Light Sconce
Warm Brass Finish
16"W x 20"H x 7"E
2C 60W
Metal Shade |
|-----------------------------------------------------------------------------------------------------------------|----------------------------------------------------------------------------------------------------------------|----------------------------------------------------------------------------------------------------------------|--------------------------------------------------------------------------------------------------------------|-------------------------------------------------------------------------------------------------------------|-------------------------------------------------------------------------------------------------------------|



A.

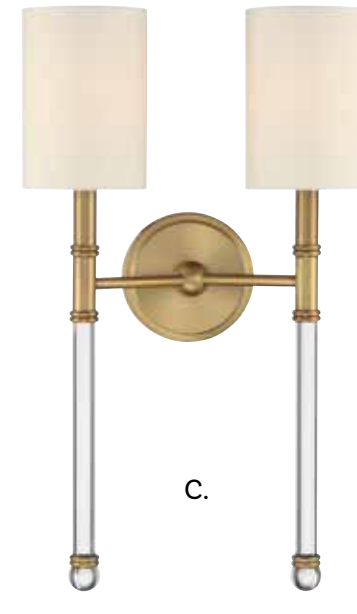

C.



D.



E.



B.



F.

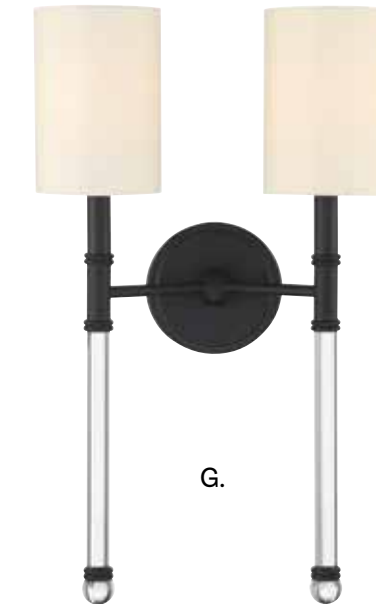

G.



H.

A. 9-103-2-SN
 2-Light Sconce
 Satin Nickel Finish
 13"W x 21"H x 6-1/4"E
 2C 60W
 Soft White Shade
 Metal Candle Covers

B. 9-101-1-SN
 1-Light Sconce
 Satin Nickel Finish
 5"W x 21"H x 7"E
 1C 60W
 Soft White Shade
 Metal Candle Cover

C. 9-103-2-322
 2-Light Sconce
 Warm Brass Finish
 13"W x 21"H x 6-1/4"E
 2C 60W
 Soft White Shades
 Metal Candle Cover

D. 9-101-1-89
 1-Light Sconce
 Matte Black Finish
 5"W x 21"H x 7"E
 1C 60W
 Soft White Shade
 Metal Candle Cover

E. 9-103-2-109
 2-Light Sconce
 Polished Nickel Finish
 13"W x 21"H x 6-1/4"E
 2C 60W
 Soft White Shades
 Metal Candle Cover

F. 9-101-1-322
 1-Light Sconce
 Warm Brass Finish
 5"W x 21"H x 7"E
 1C 60W
 Soft White Shade
 Metal Candle Cover

G. 9-103-2-89
 2-Light Sconce
 Matte Black Finish
 13"W x 21"H x 6-1/4"E
 2C 60W
 Soft White Shades
 Metal Candle Cover

H. 9-101-1-109
 1-Light Sconce
 Polished Nickel Finish
 5"W x 21"H x 7"E
 1C 60W
 Soft White Shade
 Metal Candle Cover



A. 9-302-1-SN
 1-Light Sconce
 Satin Nickel Finish
 5"W x 20"H x 6"E
 1C 60W
 White Fabric Shade
 Metal Candle Cover

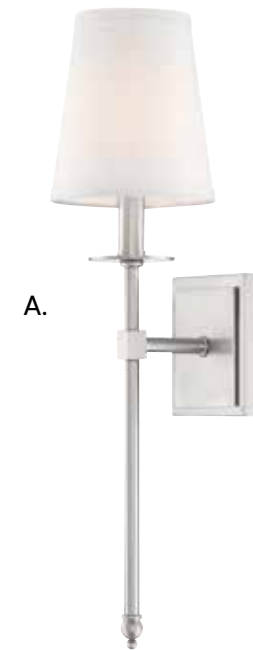

B. 9-303-1-SN
 1-Light Sconce
 Satin Nickel Finish
 5"W x 24"H x 6-1/2"E
 1C 60W
 White Fabric Shade
 Metal Candle Cover

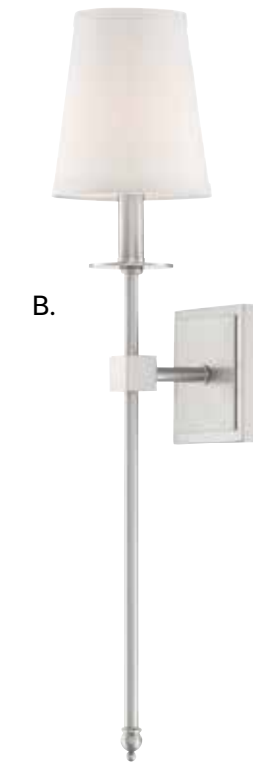

C. 9-7144-1-SN
 1-Light Sconce
 Satin Nickel Finish
 6-3/4"W x 33-1/2"H x 8"E
 1C 60W
 White Fabric Shade
 Metal Candle Cover

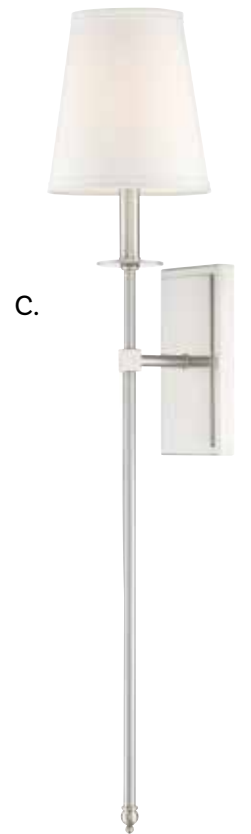

D. 9-7144-1-89
 1-Light Sconce
 Matte Black Finish
 6-3/4"W x 33-1/2"H x 8"E
 1C 60W
 White Fabric Shade
 Metal Candle Cover

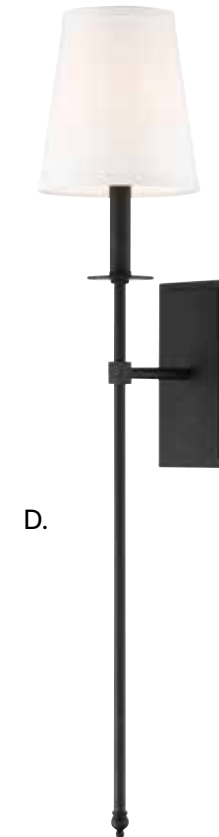

E. 9-303-1-89
 1-Light Sconce
 Matte Black Finish
 5"W x 24"H x 6-1/2"E
 1C 60W
 White Fabric Shade
 Metal Candle Cover

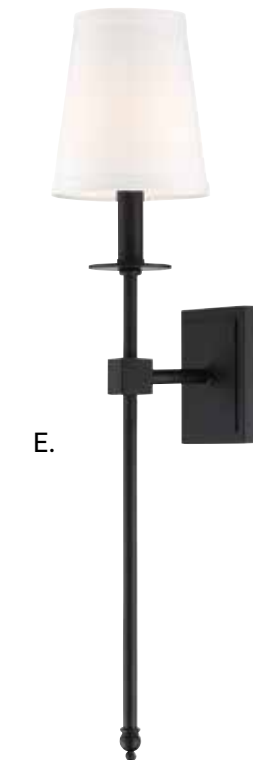

F. 9-302-1-89
 1-Light Sconce
 Matte Black Finish
 5"W x 20"H x 6"E
 1C 60W
 White Fabric Shade
 Metal Candle Cover





A.



B.



C.

A. 9-7144-1-322
 1-Light Sconce
 Warm Brass Finish
 6-3/4\"/>

B. 9-303-1-322
 1-Light Sconce
 Warm Brass Finish
 5\"/>

C. 9-302-1-322
 1-Light Sconce
 Warm Brass Finish
 5\"/>

D. 9-302-1-44
 1-Light Sconce
 Classic Bronze Finish
 5\"/>

E. 9-303-1-44
 1-Light Sconce
 Classic Bronze Finish
 5\"/>

F. 9-7144-1-44
 1-Light Sconce
 Classic Bronze Finish
 6-3/4\"/>



D.



E.



F.



G. 9-7144-1-109
 1-Light Sconce
 Polished Nickel Finish
 6-3/4\"/>

H. 9-303-1-109
 1-Light Sconce
 Polished Nickel Finish
 5\"/>

I. 9-302-1-109
 1-Light Sconce
 Polished Nickel Finish
 5\"/>



G.



H.



I.

CAMERON



- A. 9-2542-1-322**
1-Light Sconce
Warm Brass Finish
5"W x 13"H x 8"E
1C 40W
White Fabric Shade
Metal Candle Cover
- B. 9-2542-1-89**
1-Light Sconce
Matte Black Finish
5"W x 13"H x 8"E
1C 40W
White Fabric Shade
Metal Candle Cover
- C. 9-2542-1-109**
1-Light Sconce
Polished Nickel Finish
5"W x 13"H x 8"E
1C 40W
White Fabric Shade
Metal Candle Cover



A.



B.



C.

WASHBURN



- D. 9-0700-1-322**
1-Light Sconce
Warm Brass Finish
7"W x 15"H x 9"E
1C 60W
White Fabric Shade
Metal Candle Cover
- E. 9-0700-1-SN**
1-Light Sconce
Satin Nickel Finish
7"W x 15"H x 9"E
1C 60W
White Fabric Shade
Metal Candle Cover
- F. 9-0700-1-109**
1-Light Sconce
Polished Nickel Finish
7"W x 15"H x 9"E
1C 60W
White Fabric Shade
Metal Candle Cover



D.



E.



F.

DESTIN



- A. 9-0902-1-322**
1-Light Sconce
Warm Brass Finish
6"W x 25"H x 6-7/8"E
1C 60W
White Opal Glass
- B. 9-0902-1-89**
1-Light Sconce
Matte Black Finish
6"W x 25"H x 6-7/8"E
1C 60W
White Opal Glass
- C. 9-0902-1-109**
1-Light Sconce
Polished Nickel Finish
6"W x 25"H x 6-7/8"E
1C 60W
White Opal Glass

DEVON

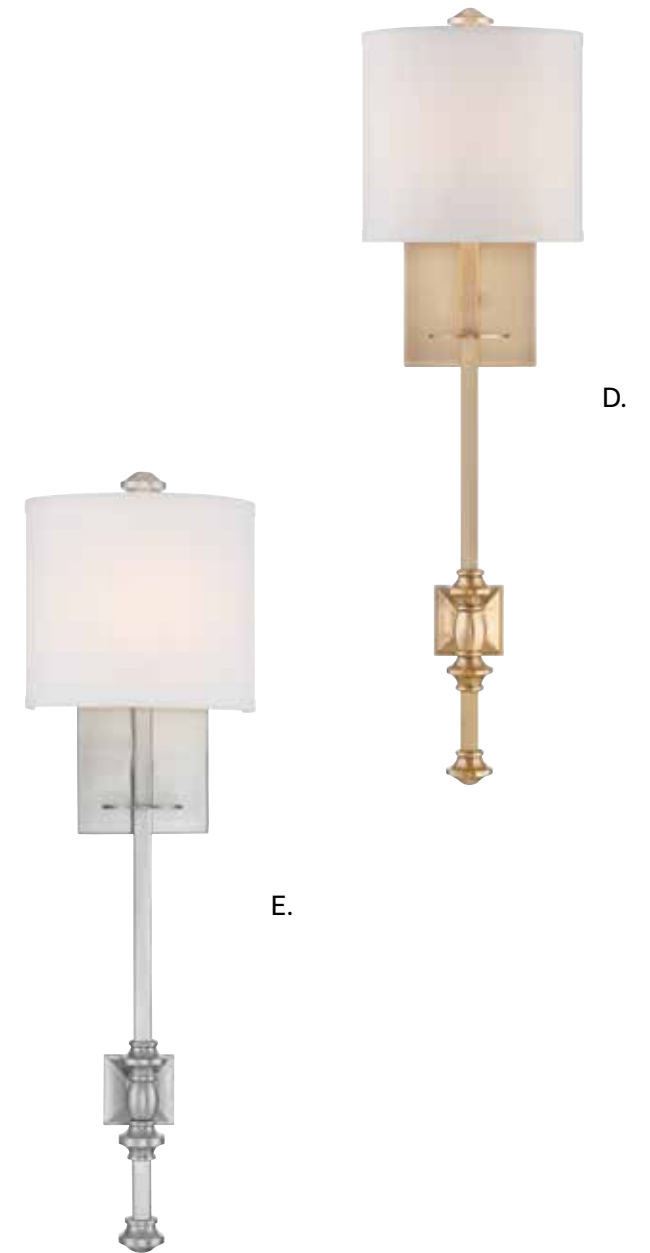

- D. 9-7140-1-322**
1-Light Sconce
Warm Brass Finish
7-1/2"W x 26-1/2"H x 5-1/2"E
1C 60W
White Fabric Shade
Metal Candle Cover
- E. 9-7140-1-SN**
1-Light Sconce
Satin Nickel Finish
7-1/2"W x 26-1/2"H x 5-1/2"E
1C 60W
White Fabric Shade
Metal Candle Cover



A.



B.



C.

A. 9-1755-1-89
1-Light Sconce
Matte Black Finish
5"W x 15"H x 5-1/2"E
1C 60W
White Fabric Shade

B. 9-1755-1-322
1-Light Sconce
Warm Brass Finish
5"W x 15"H x 5-1/2"E
1C 60W
White Fabric Shade

C. 9-1755-1-109
1-Light Sconce
Polished Nickel Finish
5"W x 15"H x 5-1/2"E
1C 60W
White Fabric Shade



Chandelier, Page 86



- | | | | |
|---------------------------------------------------------------------------------------------------------------------------------------------------------------------------------------------------------------------------------------------------------------|----------------------------------------------------------------------------------------------------------------------------------------------------------------------------------------------------------------------------------------------------------------|--------------------------------------------------------------------------------------------------------------------------------------------------------------------------------------------------------------------------------------------------------------------|---------------------------------------------------------------------------------------------------------------------------------------------------------------------------------------------------------------------------------------------------------------|
| <p>A. 9-996-1-89
 1-Light Sconce
 Matte Black Finish
 4-1/2"W x 16"H x 3-3/4"E
 1E 60W
 Clear Reeded Glass
 300mm T10 Bulb Included</p> | <p>B. 9-996-1-SN
 1-Light Sconce
 Satin Nickel Finish
 4-1/2"W x 16"H x 3-3/4"E
 1E 60W
 Clear Reeded Glass
 300mm T10 Bulb Included</p> | <p>C. 9-996-1-109
 1-Light Sconce
 Polished Nickel Finish
 4-1/2"W x 16"H x 3-3/4"E
 1E 60W
 Clear Reeded Glass
 300mm T10 Bulb Included</p> | <p>D. 9-996-1-322
 1-Light Sconce
 Warm Brass Finish
 4-1/2"W x 16"H x 3-3/4"E
 1E 60W
 Clear Reeded Glass
 300mm T10 Bulb Included</p> |
|---------------------------------------------------------------------------------------------------------------------------------------------------------------------------------------------------------------------------------------------------------------|----------------------------------------------------------------------------------------------------------------------------------------------------------------------------------------------------------------------------------------------------------------|--------------------------------------------------------------------------------------------------------------------------------------------------------------------------------------------------------------------------------------------------------------------|---------------------------------------------------------------------------------------------------------------------------------------------------------------------------------------------------------------------------------------------------------------|

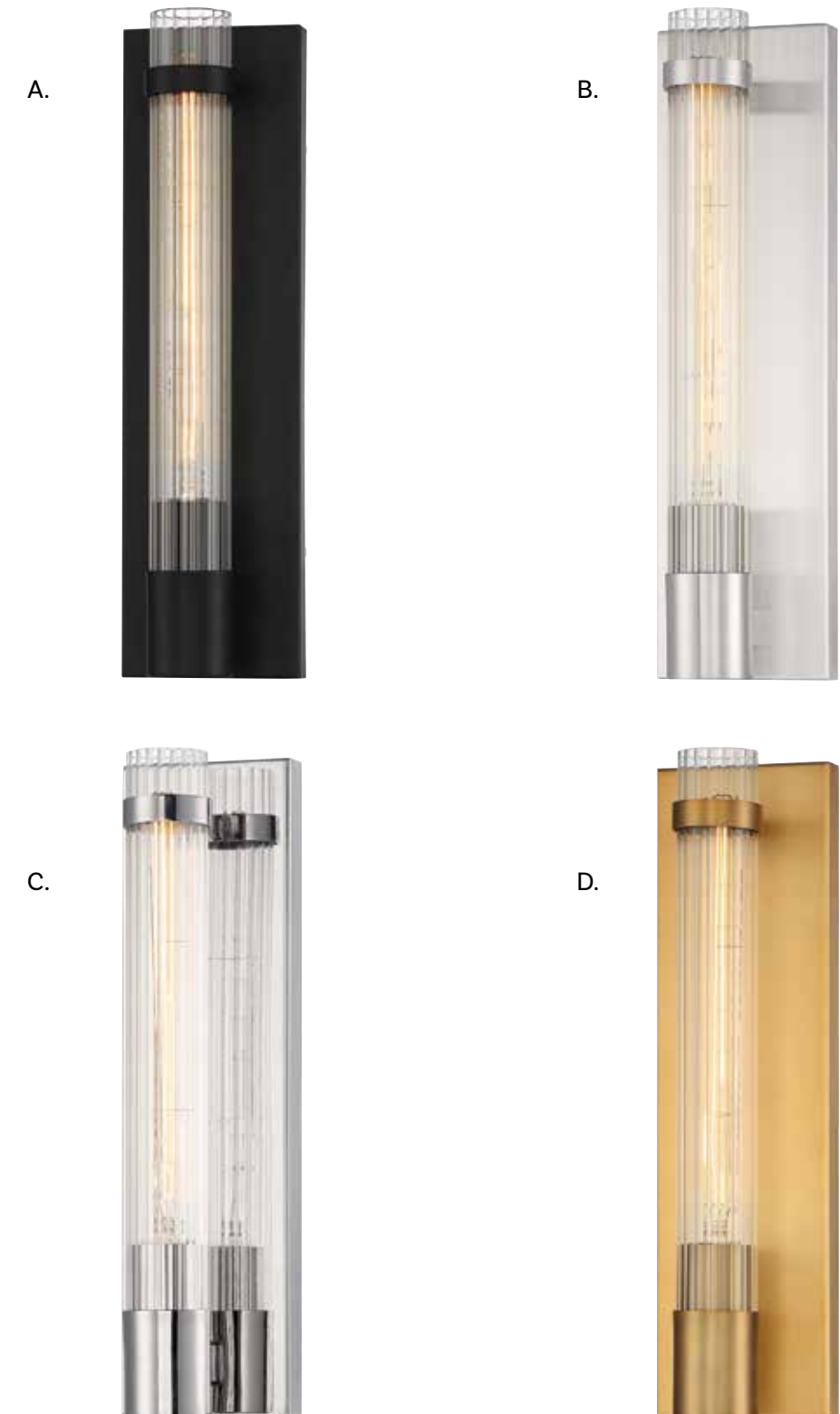

PIKE



A.



B.



C.

A. 9-16000-1-322
 1-Light Sconce
 Warm Brass Finish
 4-1/2"W x 17-3/4"H x 6-1/2"E
 1E 60W
 Clear Ribbed Glass
 300MM T9 Bulb Included

B. 9-16000-1-109
 1-Light Sconce
 Polished Nickel Finish
 4-1/2"W x 17-3/4"H x 6-1/2"E
 1E 60W
 Clear Ribbed Glass
 300MM T9 Bulb Included

C. 9-16000-1-44
 1-Light Sconce
 Classic Bronze Finish
 4-1/2"W x 17-3/4"H x 6-1/2"E
 1E 60W
 Clear Ribbed Glass
 300MM T9 Bulb Included



CLIFTON



D.



E.



F.

D. 9-900-1-109
 1-Light Sconce
 Polished Nickel Finish
 4-1/2"W x 15-1/4"H x 4-1/2"E
 1E 60W
 300MM T9 Bulb Included

E. 9-900-1-322
 1-Light Sconce
 Warm Brass Finish
 4-1/2"W x 15-1/4"H x 4-1/2"E
 1E 60W
 300MM T9 Bulb Included

F. 9-900-1-44
 1-Light Sconce
 Classic Bronze Finish
 4-1/2"W x 15-1/4"H x 4-1/2"E
 1E 60W
 300MM T9 Bulb Included

KENYON



A.



A. 9-1918-1-150
1-Light Sconce
Matte Black w/
Polished Chrome Accents
5"W x 16-1/2"H x 4-3/4"E
1E 60W

B.



B. 9-1918-1-77
1-Light Sconce
Bronze w/
Warm Brass Accents
5"W x 16-1/2"H x 4-3/4"E
1E 60W

C.



C. 9-1916-1-89
1-Light Sconce
Matte Black Finish
4-3/4"W x 17-7/8"H x 3-1/2"E
1C 60W

E.



D. 9-1916-1-322
1-Light Sconce
Warm Brass Finish
4-3/4"W x 17-7/8"H x 3-1/2"E
1C 60W

D.



E. 9-1916-1-11
1-Light Sconce
Polished Chrome Finish
4-3/4"W x 17-7/8"H x 3-1/2"E
1C 60W

DAWSON



A. 9-7005-1-89
1-Light Sconce
Matte Black Finish
8"W x 14"H x 10"E
1E 60W
Clear Seeded Glass



B. 9-7005-1-322
1-Light Pendant
Warm Brass Finish
8"W x 14"H x 10"E
1E 60W
Clear Seeded Glass



C. 9-7005-1-SN
1-Light Pendant
Satin Nickel Finish
8"W x 14"H x 10"E
1E 60W
Clear Seeded Glass



D. 9-1801-1-322
1-Light Sconce
Warm Brass Finish
10"W x 17-1/4"H x 9-1/4"E
1E 60W
Clear Water Glass



E. 9-1801-1-89
1-Light Sconce
Matte Black Finish
10"W x 17-1/4"H x 9-1/4"E
1E 60W
Clear Water Glass



F. 9-1801-1-SN
1-Light Sconce
Satin Nickel Finish
10"W x 17-1/4"H x 9-1/4"E
1E 60W
Clear Water Glass

GLENN



- A. 9-0901-1-SN**
1-Light Adjustable Sconce
Satin Nickel Finish
7"W x 12"H x 9"E
1E 60W
- B. 9-0901-1-44**
1-Light Adjustable Sconce
Classic Bronze Finish
7"W x 12"H x 9"E
1E 60W
- C. 9-0901-1-109**
1-Light Adjustable Sconce
Polished Nickel Finish
7"W x 12"H x 9"E
1E 60W
- D. 9-0901-1-322**
1-Light Adjustable Sconce
Warm Brass Finish
7"W x 12"H x 9"E
1E 60W
- E. 9-0901-1-89**
1-Light Adjustable Sconce
Matte Black Finish
7"W x 12"H x 9"E
1E 60W

WAVERLY



- F. 9-1200-1-SN**
1-Light Sconce
Satin Nickel Finish
5"W x 11"H x 6-1/2"E
1C 60W
White Fabric Shade
Metal Candle Cover
- G. 9-1200-1-89**
1-Light Sconce
Matte Black Finish
5"W x 11"H x 6-1/2"E
1C 60W
White Fabric Shade
Metal Candle Cover
- H. 9-1200-1-322**
1-Light Sconce
Warm Brass Finish
5"W x 11"H x 6-1/2"E
1C 60W
White Fabric Shade
Metal Candle Cover
- I. 9-1200-1-109**
1-Light Sconce
Polished Nickel Finish
5"W x 11"H x 6-1/2"E
1C 60W
White Fabric Shade
Metal Candle Cover

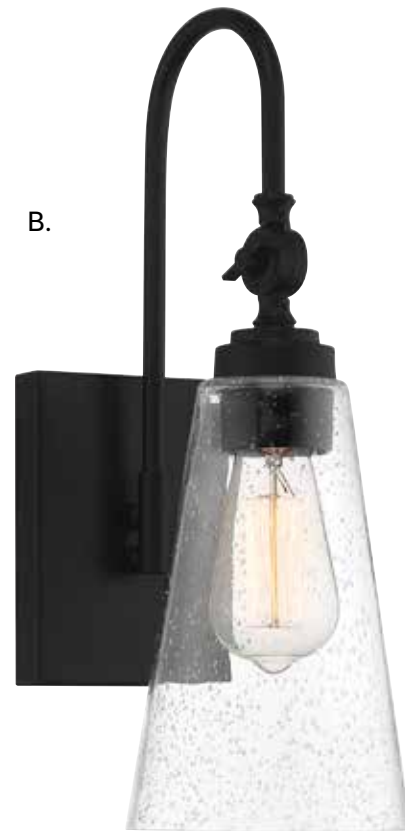
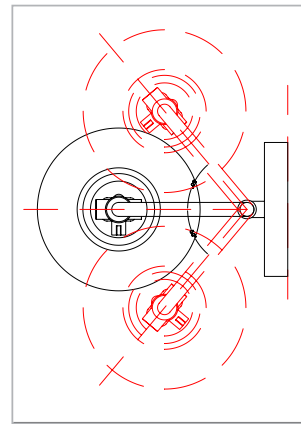

A. 9-108-1-SN
 1-Light Adjustable Sconce
 Satin Nickel Finish
 5-1/2"W x 16"H x 8-1/2"E
 1E 60W
 100° Swivel
 Clear Seeded Glass

B. 9-108-1-89
 1-Light Adjustable Sconce
 Matte Black Finish
 5-1/2"W x 16"H x 8-1/2"E
 1E 60W
 100° Swivel
 Clear Seeded Glass

C. 9-108-1-322
 1-Light Adjustable Sconce
 Warm Brass Finish
 5-1/2"W x 16"H x 8-1/2"E
 1E 60W
 100° Swivel
 Clear Seeded Glass

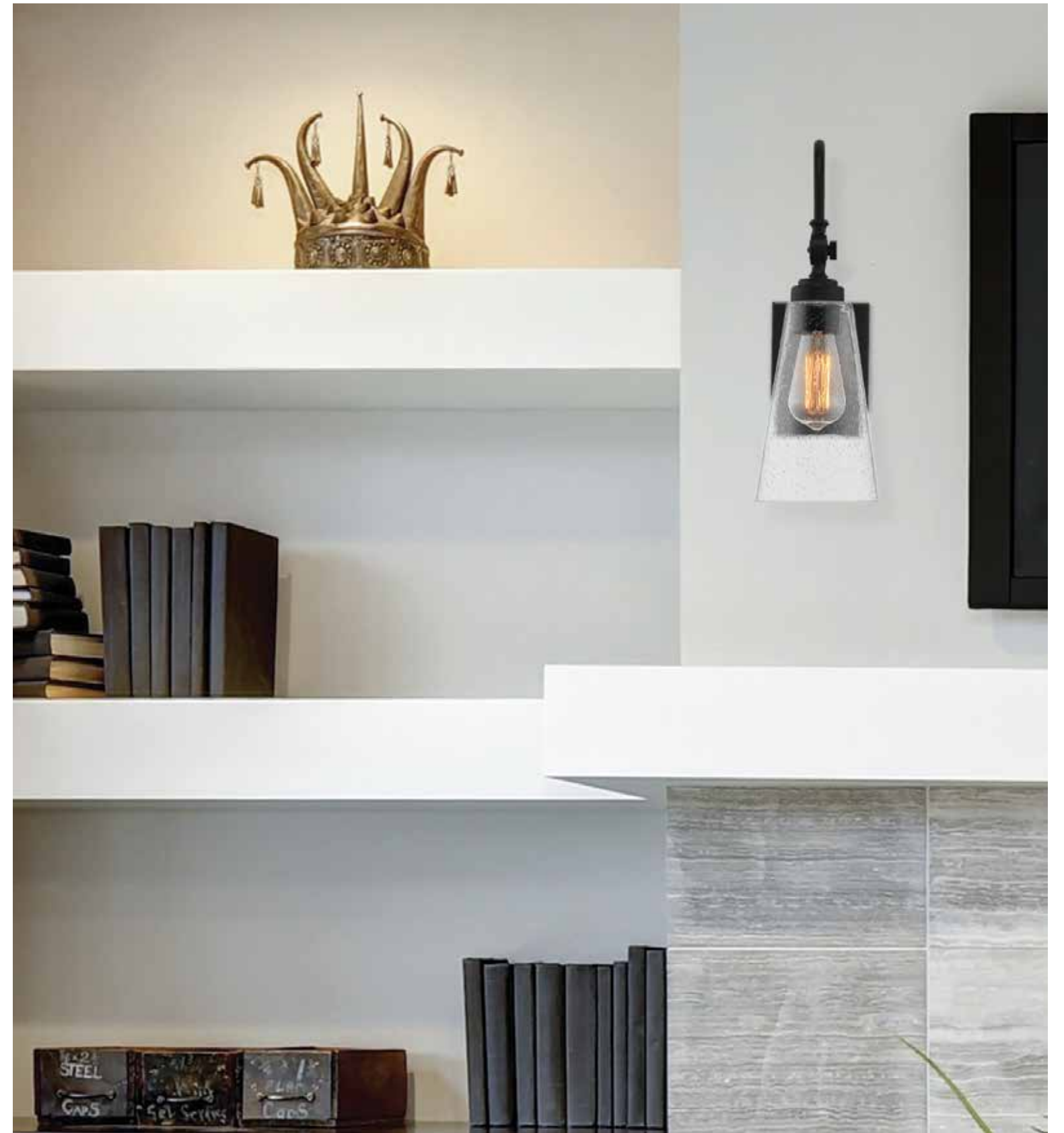

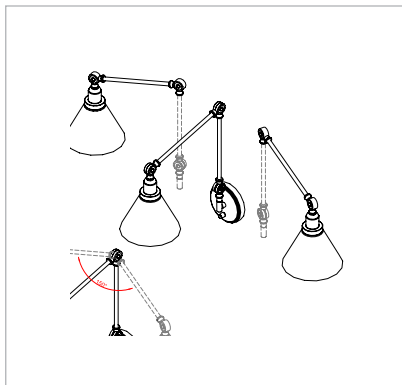
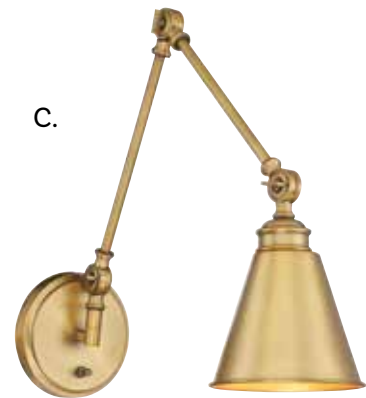

A. 9-961CP-1-89

1-Light Adjustable Sconce
Matte Black Finish
6"W x 16"H x 13"E
Adj E 13" - 33-3/4"
1E 60W

B. 9-961CP-1-13

1-Light Adjustable Sconce
English Bronze Finish
6"W x 16"H x 13"E
Adj E 13" - 33-3/4"
1E 60W

C. 9-961CP-1-322

1-Light Adjustable Sconce
Warm Brass Finish
6"W x 16"H x 13"E
Adj E 13" - 33-3/4"
1E 60W

D. 9-961CP-1-109

1-Light Adjustable Sconce
Polished Nickel Finish
6"W x 16"H x 13"E
Adj E 13" - 33-3/4"
1E 60W

E. 9-961CP-1-SN

1-Light Adjustable Sconce
Satin Nickel Finish
6"W x 16"H x 13"E
Adj E 13" - 33-3/4"
1E 60W

Includes cord, plug, and hardwire hardware

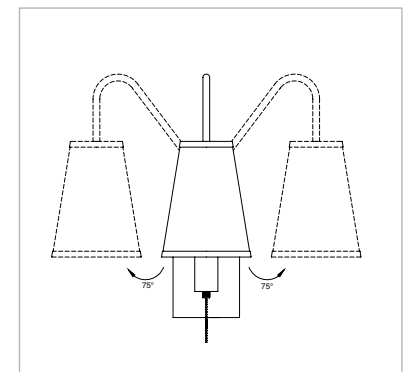

F. 9-0900CP-1-322

1-Light Adjustable Sconce
Warm Brass Finish
6-1/8"W x 12-3/8"H x 6"E
Adj E 6" - 12"
1E 60W
White Fabric Shade
Decorative Pull-Chain

G. 9-0900CP-1-13

1-Light Adjustable Sconce
English Bronze Finish
6-1/8"W x 12-3/8"H x 6"E
Adj E 6" - 12"
1E 60W
White Fabric Shade
Decorative Pull-Chain

H. 9-0900CP-1-89

1-Light Adjustable Sconce
Matte Black Finish
6-1/8"W x 12-3/8"H x 6"E
Adj E 6" - 12"
1E 60W
White Fabric Shade
Decorative Pull-Chain

I. 9-0900CP-1-109

1-Light Adjustable Sconce
Polished Nickel Finish
6-1/8"W x 12-3/8"H x 6"E
Adj E 6" - 12"
1E 60W
White Fabric Shade
Decorative Pull-Chain

J. 9-0900CP-1-SN

1-Light Adjustable Sconce
Satin Nickel Finish
6-1/8"W x 12-3/8"H x 6"E
Adj E 6" - 12"
1E 60W
White Fabric Shade
Decorative Pull-Chain



A.



B.

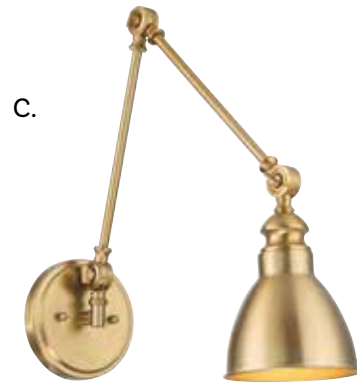

C.

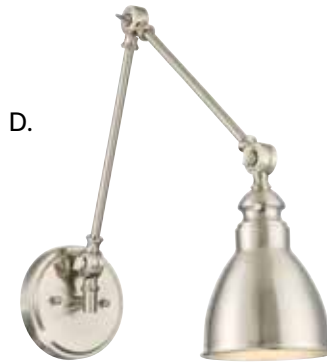

D.

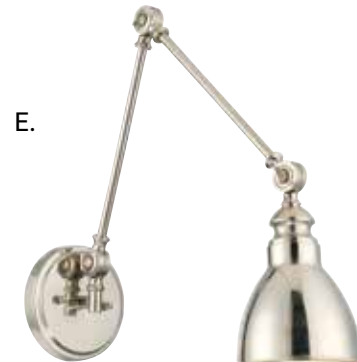

E.

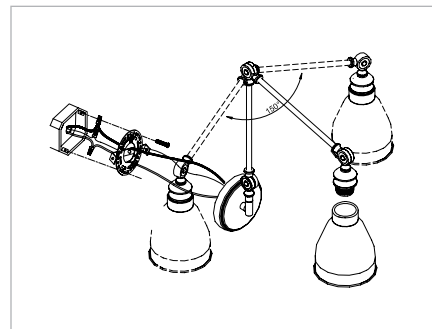

A. 9-960-1-89
1-Light Adjustable Sconce
Matte Black Finish
5-1/2"W x 17"H x 13"E
Adj E 13" - 33-3/4"
1E 60W

B. 9-960-1-13
1-Light Adjustable Sconce
English Bronze Finish
5-1/2"W x 17"H x 13"E
Adj E 13" - 33-3/4"
1E 60W

C. 9-960-1-322
1-Light Adjustable Sconce
Warm Brass Finish
5-1/2"W x 17"H x 13"E
Adj E 13" - 33-3/4"
1E 60W

D. 9-960-1-SN
1-Light Adjustable Sconce
Satin Nickel Finish
5-1/2"W x 17"H x 13"E
Adj E 13" - 33-3/4"
1E 60W

E. 9-960-1-109
1-Light Adjustable Sconce
Polished Nickel Finish
5-1/2"W x 17"H x 13"E
Adj E 13" - 33-3/4"
1E 60W



F.

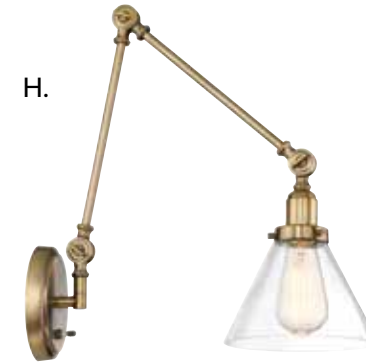

H.



I.



J.



G.

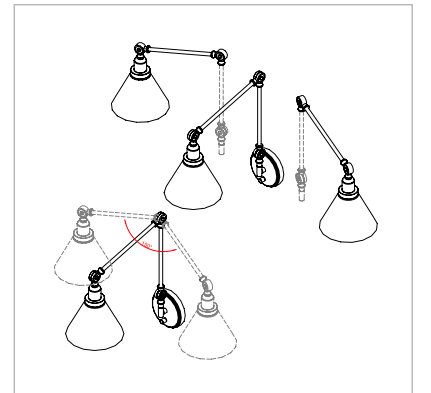

F. 9-9131CP-1-13
1-Light Adjustable Sconce
English Bronze Finish
7-1/2"W x 17-1/2"H x 14"E
Adj E 14" - 34-1/2"
1E 60W
Clear Glass

G. 9-9131CP-1-89
1-Light Adjustable Sconce
Matte Black Finish
7-1/2"W x 17-1/2"H x 14"E
Adj E 14" - 34-1/2"
1E 60W
Clear Glass

H. 9-9131CP-1-322
1-Light Adjustable Sconce
Warm Brass Finish
7-1/2"W x 17-1/2"H x 14"E
Adj E 14" - 34-1/2"
1E 60W
Clear Glass

I. 9-9131CP-1-109
1-Light Adjustable Sconce
Polished Nickel Finish
7-1/2"W x 17-1/2"H x 14"E
Adj E 14" - 34-1/2"
1E 60W
Clear Glass

J. 9-9131CP-1-SN
1-Light Adjustable Sconce
Satin Nickel Finish
7-1/2"W x 17-1/2"H x 14"E
Adj E 14" - 34-1/2"
1E 60W
Clear Glass

Includes cord, plug, and hardware hardware

WALL LIGHTING

A. MELROSE

9-6836-1-11
1-Light Sconce
Polished Chrome Finish
5"W x 7-3/4"H x 6-3/4"E
1E 60W
White Opal Etched Glass



A.

B. MELROSE

9-6836-1-13
1-Light Sconce
English Bronze Finish
5"W x 7-3/4"H x 6-3/4"E
1E 60W
White Opal Etched Glass



B.

C. MELROSE

9-6836-1-SN
1-Light Sconce
Satin Nickel Finish
5"W x 7-3/4"H x 6-3/4"E
1E 60W
White Opal Etched Glass



C.

D. MELROSE

9-6836-1-322
1-Light Sconce
Warm Brass Finish
5"W x 7-3/4"H x 6-3/4"E
1E 60W
White Opal Etched Glass



D.

E. HERNDON

9-1007-1-SN
1-Light Sconce
Satin Nickel Finish
5-1/2"W x 10-3/4"H x 7-1/2"E
1E 60W
Frosted White Glass



E.

F. HAMPTON

9-1972-1-322
1-Light Sconce
Warm Brass Finish
4-3/4"W x 9-7/8"H x 6-1/2"E
1E 60W
Clear Crackled Glass



F.

G. COLTON

9-337-1-13
1-Light Sconce
English Bronze Finish
4-3/4"W x 10"H x 6"E
1E 60W
White Opal Glass



G.

H. COLTON

9-337-1-SN
1-Light Sconce
Satin Nickel Finish
4-3/4"W x 10"H x 6"E
1E 60W
White Opal Glass



H.

WALL LIGHTING

I. CARSON

9-4050-1-322
1-Light Sconce
Warm Brass Finish
5-1/2"W x 8-1/2"H x 7"E
1E 60W
Clear Glass



I.

J. CARSON

9-4050-1-BK
1-Light Sconce
Matte Black Finish
5-1/2"W x 8-1/2"H x 7"E
1E 60W
Clear Glass



J.

K. CARSON

9-4050-1-SN
1-Light Sconce
Satin Nickel Finish
5-1/2"W x 8-1/2"H x 7"E
1E 60W
Clear Glass



K.

L. OCTAVE

9-4030-1-322
1-Light Sconce
Warm Brass Finish
5"W x 9-1/2"H x 6"E
1E 60W
Clear Glass



L.

M. OCTAVE

9-4030-1-BK
1-Light Sconce
Matte Black Finish
5"W x 9-1/2"H x 6"E
1E 60W
Clear Glass



M.

N. OCTAVE

9-4030-1-SN
1-Light Sconce
Satin Nickel Finish
5"W x 9-1/2"H x 6"E
1E 60W
Clear Glass



N.

O. OCTAVE

9-4030-1-13
1-Light Sconce
English Bronze Finish
5"W x 9-1/2"H x 6"E
1E 60W
Clear Glass



O.

P. OCTAVE

9-4030-1-11
1-Light Sconce
Polished Chrome Finish
5"W x 9-1/2"H x 6"E
1E 60W
Clear Glass



P.

Q. ELISE

8-9127-1-SN
1-Light Sconce
Satin Nickel Finish
4-1/2"W x 10-1/2"H x 6-1/2"E
1E 60W
Frosted Opal Glass



Q.

GARNET



- A. 9-6001-1-322**
1-Light Sconce
Warm Brass Finish
5-1/2"W x 20-1/2"H x 7"E
1E 60W
Clear Crystal
- B. 9-6001-1-89**
1-Light Sconce
Matte Black Finish
5-1/2"W x 20-1/2"H x 7"E
1E 60W
Clear Crystal
- C. 9-6001-1-109**
1-Light Sconce
Polished Nickel Finish
5-1/2"W x 20-1/2"H x 7"E
1E 60W
Clear Crystal
- D. 8-6001-4-322**
4-Light Bath Bar
Warm Brass Finish
32"W x 9-1/2"H x 7"E
4E 60W
Clear Crystal



- E. 8-6001-3-322**
3-Light Bath Bar
Warm Brass Finish
24"W x 9-1/2"H x 7"E
3E 60W
Clear Crystal
- F. 8-6001-2-322**
2-Light Bath Bar
Warm Brass Finish
16"W x 9-1/2"H x 7"E
2E 60W
Clear Crystal
- G. 8-6001-4-BK**
4-Light Bath Bar
Matte Black Finish
32"W x 9-1/2"H x 7"E
4E 60W
Clear Crystal
- H. 8-6001-3-BK**
3-Light Bath Bar
Matte Black Finish
24"W x 9-1/2"H x 7"E
3E 60W
Clear Crystal
- I. 8-6001-2-BK**
2-Light Bath Bar
Matte Black Finish
16"W x 9-1/2"H x 7"E
2E 60W
Clear Crystal
- J. 8-6001-4-109**
4-Light Bath Bar
Polished Nickel Finish
32"W x 9-1/2"H x 7"E
4E 60W
Clear Crystal
- K. 8-6001-3-109**
3-Light Bath Bar
Polished Nickel Finish
24"W x 9-1/2"H x 7"E
3E 60W
Clear Crystal
- L. 8-6001-2-109**
2-Light Bath Bar
Polished Nickel Finish
16"W x 9-1/2"H x 7"E
2E 60W
Clear Crystal

Fixtures may be mounted either upright or downlight



Fixtures may be mounted either uplight or downlight



- A. 8-1745-4-BK**
4-Light Bath Bar
Matte Black Finish
30-1/2"W x 10"H x 7"E
4E 60W
Clear Ribbed Glass
- B. 8-1745-3-BK**
3-Light Bath Bar
Matte Black Finish
22"W x 10"H x 7"E
3E 60W
Clear Ribbed Glass
- C. 8-1745-2-BK**
2-Light Bath Bar
Matte Black Finish
14"W x 10"H x 7"E
2E 60W
Clear Ribbed Glass
- D. 8-1745-4-322**
4-Light Bath Bar
Warm Brass Finish
30-1/2"W x 10"H x 7"E
4E 60W
Clear Ribbed Glass
- E. 8-1745-3-322**
3-Light Bath Bar
Warm Brass Finish
22"W x 10"H x 7"E
3E 60W
Clear Ribbed Glass
- F. 8-1745-2-322**
2-Light Bath Bar
Warm Brass Finish
14"W x 10"H x 7"E
2E 60W
Clear Ribbed Glass
- G. 8-1745-4-109**
4-Light Bath Bar
Polished Nickel Finish
30-1/2"W x 10"H x 7"E
4E 60W
Clear Ribbed Glass
- H. 8-1745-3-109**
3-Light Bath Bar
Polished Nickel Finish
22"W x 10"H x 7"E
3E 60W
Clear Ribbed Glass
- I. 8-1745-2-109**
2-Light Bath Bar
Polished Nickel Finish
14"W x 10"H x 7"E
2E 60W
Clear Ribbed Glass



Fixtures may be mounted either uplight or downlight.



- A. 8-1020-4-SN**
4-Light Bath Bar
Satin Nickel Finish
32"W x 8-3/4"H x 6-3/8"E
4E 60W
Clear Glass
- B. 8-1020-3-SN**
3-Light Bath Bar
Satin Nickel Finish
24"W x 8-3/4"H x 6-3/8"E
3E 60W
Clear Glass
- C. 8-1020-2-SN**
2-Light Bath Bar
Satin Nickel Finish
14-5/8"W x 8-3/4"H x 6-3/8"E
2E 60W
Clear Glass
- D. 8-1020-4-BK**
4-Light Bath Bar
Matte Black Finish
32"W x 8-3/4"H x 6-3/8"E
4E 60W
Clear Glass
- E. 8-1020-3-BK**
3-Light Bath Bar
Matte Black Finish
24"W x 8-3/4"H x 6-3/8"E
3E 60W
Clear Glass
- F. 8-1020-2-BK**
2-Light Bath Bar
Matte Black Finish
14-5/8"W x 8-3/4"H x 6-3/8"E
2E 60W
Clear Glass
- G. 8-1020-4-322**
4-Light Bath Bar
Warm Brass Finish
32"W x 8-3/4"H x 6-3/8"E
4E 60W
Clear Glass
- H. 8-1020-3-322**
3-Light Bath Bar
Warm Brass Finish
24"W x 8-3/4"H x 6-3/8"E
3E 60W
Clear Glass
- I. 8-1020-2-322**
2-Light Bath Bar
Warm Brass Finish
14-5/8"W x 8-3/4"H x 6-3/8"E
2E 60W
Clear Glass

BALLAS



Fixtures may be mounted either uplight or downlight.

BALLAS

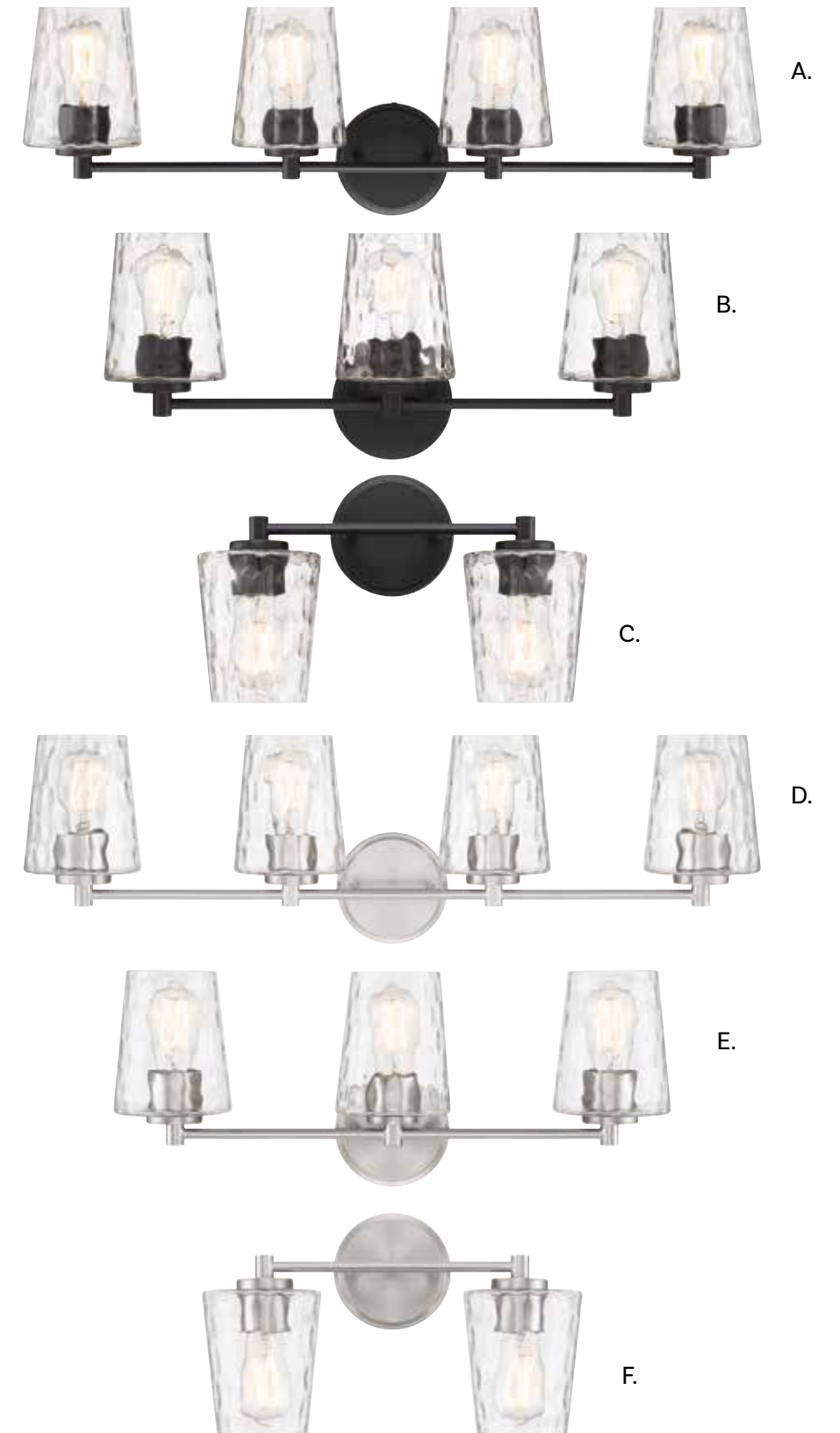

- A. 8-5606-4-BK**
4-Light Bath Bar
Matte Black Finish
31-1/2"W x 9-3/4"H x 6-1/2"E
4E 60W
Clear Hammered Glass
- B. 8-5606-3-BK**
3-Light Bath Bar
Matte Black Finish
23-1/2"W x 9-3/4"H x 6-1/2"E
3E 60W
Clear Hammered Glass
- C. 8-5606-2-BK**
2-Light Bath Bar
Matte Black Finish
15-1/2"W x 9-3/4"H x 6-1/2"E
2E 60W
Clear Hammered Glass
- D. 8-5606-4-SN**
4-Light Bath Bar
Satin Nickel Finish
31-1/2"W x 9-3/4"H x 6-1/2"E
4E 60W
Clear Hammered Glass
- E. 8-5606-3-SN**
3-Light Bath Bar
Satin Nickel Finish
23-1/2"W x 9-3/4"H x 6-1/2"E
3E 60W
Clear Hammered Glass
- F. 8-5606-2-SN**
2-Light Bath Bar
Satin Nickel Finish
15-1/2"W x 9-3/4"H x 6-1/2"E
2E 60W
Clear Hammered Glass

SACREMENTO



Fixtures may be mounted either uplight or downlight.

SACREMENTO

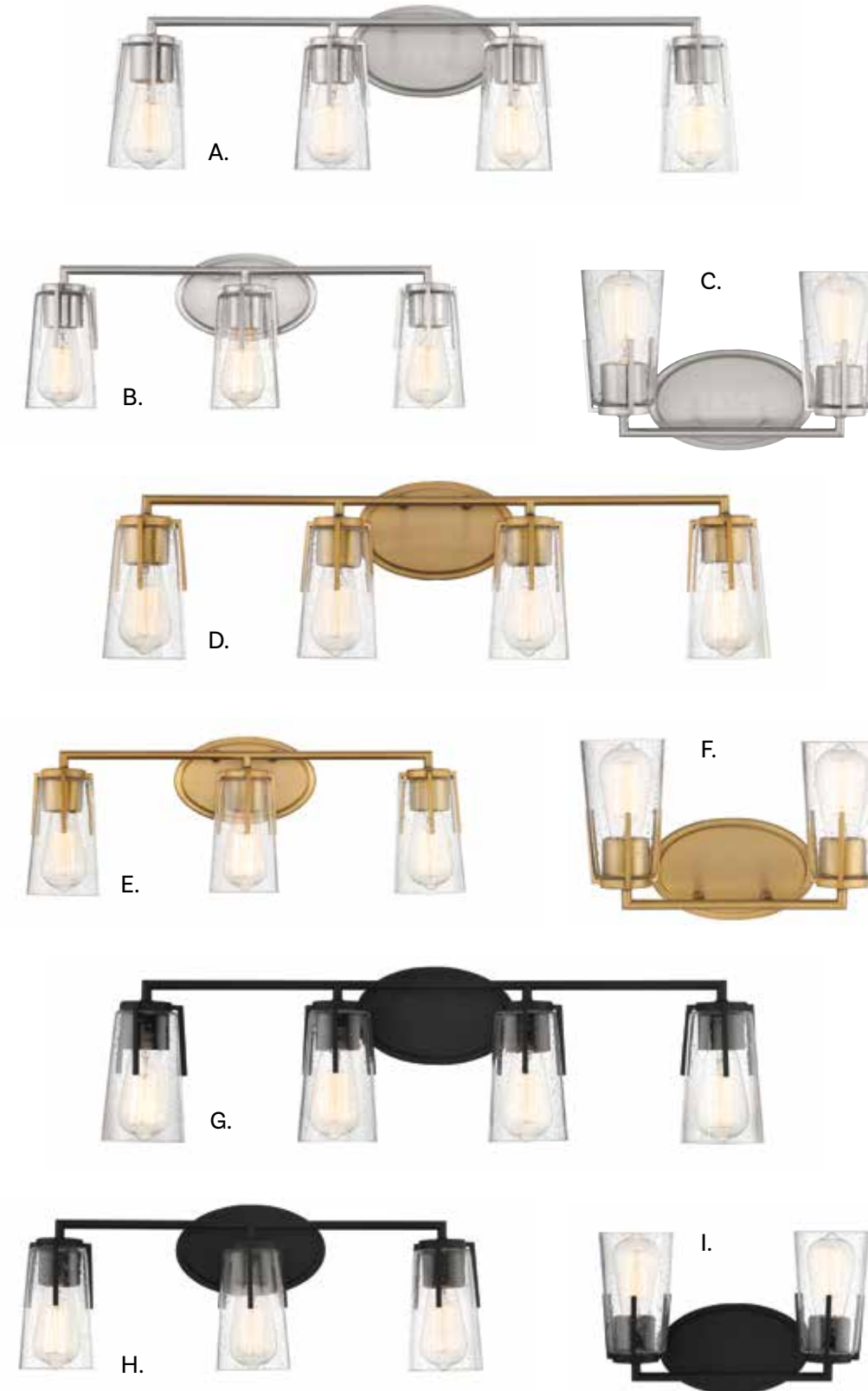

- A. 8-7045-4-SN**
4-Light Bath Bar
Satin Nickel Finish
32W x 8-1/2"H x 5-3/8"E
4E 60W
Clear Seeded Glass
- B. 8-7045-3-SN**
3-Light Bath Bar
Satin Nickel Finish
24"W x 8-1/2"H x 5-3/8"E
3E 60W
Clear Seeded Glass
- C. 8-7045-2-SN**
2-Light Bath Bar
Satin Nickel Finish
14"W x 8-1/2"H x 5-3/8"E
2E 60W
Clear Seeded Glass
- D. 8-7045-4-322**
4-Light Bath Bar
Warm Brass Finish
32W x 8-1/2"H x 5-3/8"E
4E 60W
Clear Seeded Glass
- E. 8-7045-3-322**
3-Light Bath Bar
Warm Brass Finish
24"W x 8-1/2"H x 5-3/8"E
3E 60W
Clear Seeded Glass
- F. 8-7045-2-322**
2-Light Bath Bar
Warm Brass Finish
14"W x 8-1/2"H x 5-3/8"E
2E 60W
Clear Seeded Glass
- G. 8-7045-4-BK**
4-Light Bath Bar
Matte Black Finish
32W x 8-1/2"H x 5-3/8"E
4E 60W
Clear Seeded Glass
- H. 8-7045-3-BK**
3-Light Bath Bar
Matte Black Finish
24"W x 8-1/2"H x 5-3/8"E
3E 60W
Clear Seeded Glass
- I. 8-7045-2-BK**
2-Light Bath Bar
Matte Black Finish
14"W x 8-1/2"H x 5-3/8"E
2E 60W
Clear Seeded Glass



Fixtures may be mounted either uplight or downlight



A. 8-2603-6-BK
6-Light Bath Bar
Matte Black Finish
34"W x 8-3/4"H x 5-1/2"E
6E 60W
Clear Water Glass

B. 8-2603-4-BK
4-Light Bath Bar
Matte Black Finish
22"W x 8-3/4"H x 5-1/2"E
4E 60W
Clear Water Glass

C. 8-2603-6-CH
6-Light Bath Bar
Polished Chrome Finish
34"W x 8-3/4"H x 5-1/2"E
6E 60W
Clear Water Glass

D. 8-2603-4-CH
4-Light Bath Bar
Polished Chrome Finish
22"W x 8-3/4"H x 5-1/2"E
4E 60W
Clear Water Glass



Fixtures may be mounted either uplight or downlight.

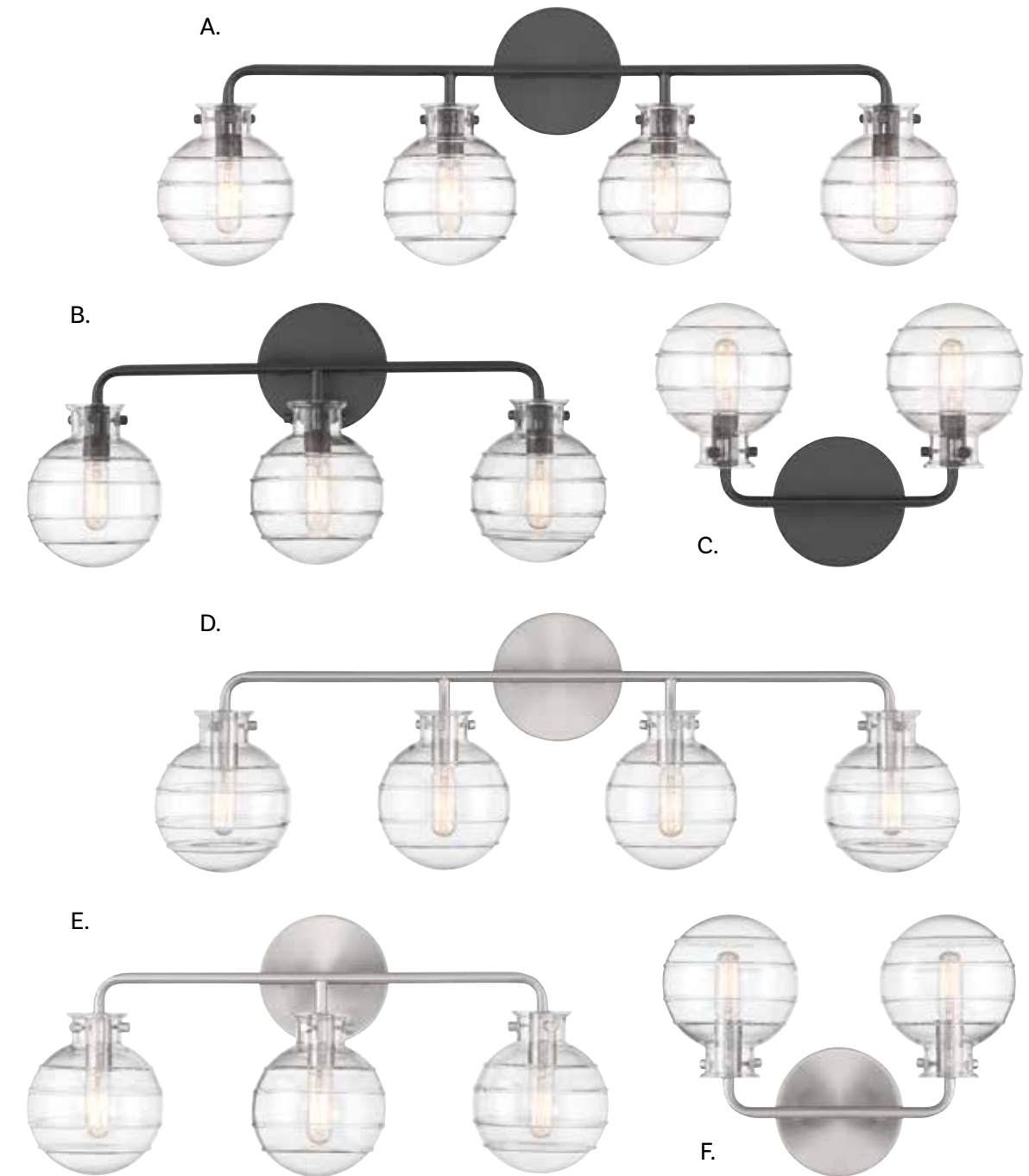

- | | | | | | |
|-----------------------|-----------------------|-----------------------|-----------------------|-----------------------|-----------------------|
| A. 8-4300-4-BK | B. 8-4300-3-BK | C. 8-4300-2-BK | D. 8-4300-4-SN | E. 8-4300-3-SN | F. 8-4300-2-SN |
| 4-Light Bath Bar | 3-Light Bath Bar | 2-Light Bath Bar | 4-Light Bath Bar | 3-Light Bath Bar | 2-Light Bath Bar |
| Matte Black Finish | Matte Black Finish | Matte Black Finish | Satin Nickel Finish | Satin Nickel Finish | Satin Nickel Finish |
| 30-1/2"W x 10"H x | 22"W x 10"H x | 13-1/2"W x 10"H x | 30-1/2"W x 10"H x | 22"W x 10"H x | 13-1/2"W x 10"H x |
| 6-1/4"E | 6-1/4"E | 6-1/4"E | 6-1/4"E | 6-1/4"E | 6-1/4"E |
| 4C 60W | 3C 60W | 2C 60W | 4C 60W | 3C 60W | 2C 60W |
| Clear Swirl Glass | Clear Swirl Glass | Clear Swirl Glass | Clear Swirl Glass | Clear Swirl Glass | Clear Swirl Glass |



- A. 8-4050-4-SN**
4-Light Bath Bar
Satin Nickel Finish
30"W x 8-1/2"H x 7"E
4E 60W
Clear Glass
- B. 8-4050-3-SN**
3-Light Bath Bar
Satin Nickel Finish
22-1/2"W x 8-1/2"H x 7"E
3E 60W
Clear Glass
- C. 9-4050-1-SN**
1-Light Sconce
Satin Nickel Finish
5-1/2"W x 8-1/2"H x 7"E
1E 60W
Clear Glass
- D. 8-4050-2-SN**
2-Light Bath Bar
Satin Nickel Finish
14"W x 8-1/2"H x 7"E
2E 60W
Clear Glass

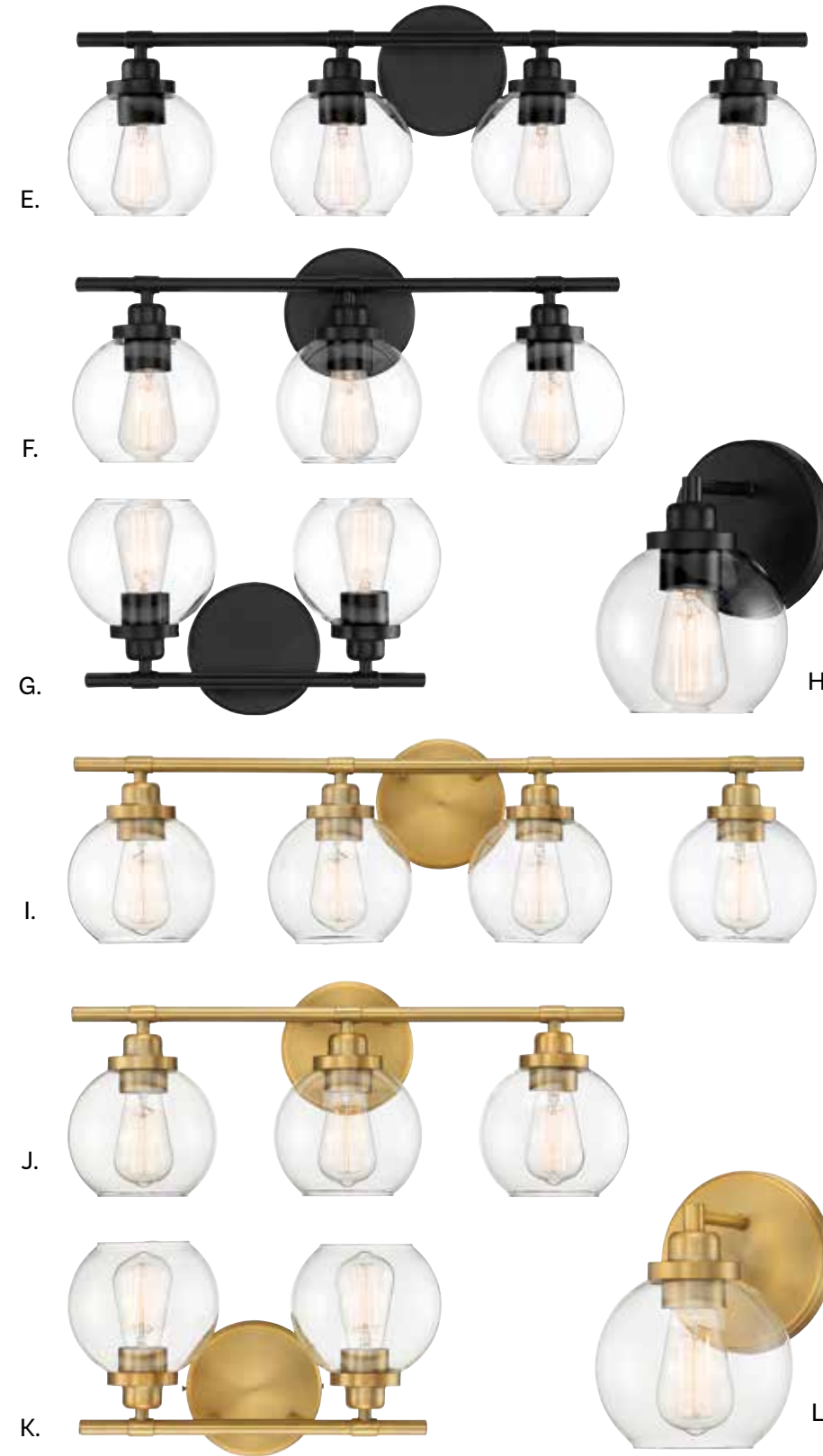

- E. 8-4050-4-BK**
4-Light Bath Bar
Matte Black Finish
30"W x 8-1/2"H x 7"E
4E 60W
Clear Glass
- F. 8-4050-3-BK**
3-Light Bath Bar
Matte Black Finish
22-1/2"W x 8-1/2"H x 7"E
3E 60W
Clear Glass
- G. 8-4050-2-BK**
2-Light Bath Bar
Matte Black Finish
14"W x 8-1/2"H x 7"E
2E 60W
Clear Glass
- H. 9-4050-1-BK**
1-Light Sconce
Matte Black Finish
5-1/2"W x 8-1/2"H x 7"E
1E 60W
Clear Glass
- I. 8-4050-4-322**
4-Light Bath Bar
Warm Brass Finish
30"W x 8-1/2"H x 7"E
4E 60W
Clear Glass
- J. 8-4050-3-322**
3-Light Bath Bar
Warm Brass Finish
22-1/2"W x 8-1/2"H x 7"E
3E 60W
Clear Glass
- K. 8-4050-2-322**
2-Light Bath Bar
Warm Brass Finish
14"W x 8-1/2"H x 7"E
2E 60W
Clear Glass
- L. 9-4050-1-322**
1-Light Sconce
Warm Brass Finish
5-1/2"W x 8-1/2"H x 7"E
1E 60W
Clear Glass

Fixtures may be mounted either upright or downlight.



A. 9-3076-1-89
1-Light Sconce
Matte Black Finish
5-3/4"W x 10"H x 7-1/2"E
1E 60W
Clear Glass

B. 9-3076-1-322
1-Light Sconce
Warm Brass Finish
5-3/4"W x 10"H x 7-1/2"E
1E 60W
Clear Glass

C. 9-3076-1-11
1-Light Sconce
Polished Chrome Finish
5-3/4"W x 10"H x 7-1/2"E
1E 60W
Clear Glass



A.

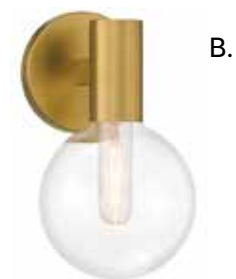

B.



C.

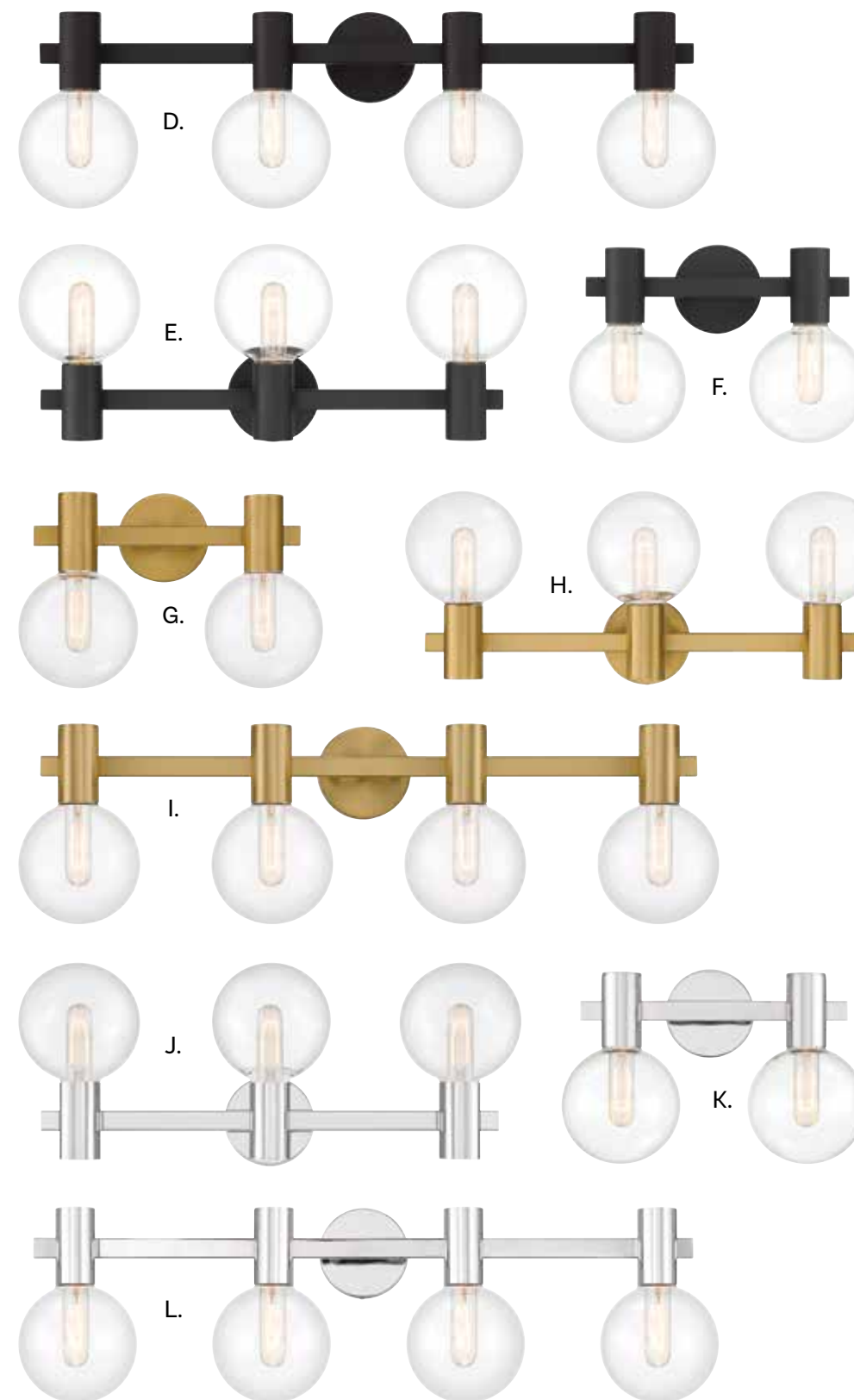

D. 8-3076-4-BK
4-Light Bath Bar
Matte Black Finish
34"W x 10"H x 7-1/2"E
4E 60W
Clear Glass

E. 8-3076-3-BK
3-Light Bath Bar
Matte Black Finish
25"W x 10"H x 7-1/2"E
3E 60W
Clear Glass

F. 8-3076-2-BK
2-Light Bath Bar
Matte Black Finish
15-1/2"W x 10"H x 7-1/2"E
2E 60W
Clear Glass

G. 8-3076-2-322
2-Light Bath Bar
Warm Brass Finish
15-1/2"W x 10"H x 7-1/2"E
2E 60W
Clear Glass

H. 8-3076-3-322
3-Light Bath Bar
Warm Brass Finish
25"W x 10"H x 7-1/2"E
3E 60W
Clear Glass

I. 8-3076-4-322
4-Light Bath Bar
Warm Brass Finish
34"W x 10"H x 7-1/2"E
4E 60W
Clear Glass

J. 8-3076-3-11
3-Light Bath Bar
Polished Chrome Finish
25"W x 10"H x 7-1/2"E
3E 60W
Clear Glass

K. 8-3076-2-11
2-Light Bath Bar
Polished Chrome Finish
15-1/2"W x 10"H x 7-1/2"E
2E 60W
Clear Glass

L. 8-3076-4-11
4-Light Bath Bar
Polished Chrome Finish
34"W x 10"H x 7-1/2"E
4E 60W
Clear Glass

Fixtures may be mounted either upright or downlight

- A. 8-1860-4-322**
4-Light Bath Bar
Warm Brass Finish
33"W x 10-1/2"H x 7-1/2"E
4C 60W
Clear Glass
- B. 8-1860-3-322**
3-Light Bath Bar
Warm Brass Finish
24"W x 10-1/2"H x 7-1/2"E
3C 60W
Clear Glass
- C. 8-1860-2-322**
2-Light Bath Bar
Warm Brass Finish
16"W x 10-1/2"H x 7-1/2"E
2C 60W
Clear Glass
- D. 8-1860-2-BK**
2-Light Bath Bar
Matte Black Finish
16"W x 10-1/2"H x 7-1/2"E
2C 60W
Clear Glass
- E. 8-1860-3-BK**
3-Light Bath Bar
Matte Black Finish
24"W x 10-1/2"H x 7-1/2"E
3C 60W
Clear Glass
- F. 8-1860-4-BK**
4-Light Bath Bar
Matte Black Finish
33"W x 10-1/2"H x 7-1/2"E
4C 60W
Clear Glass

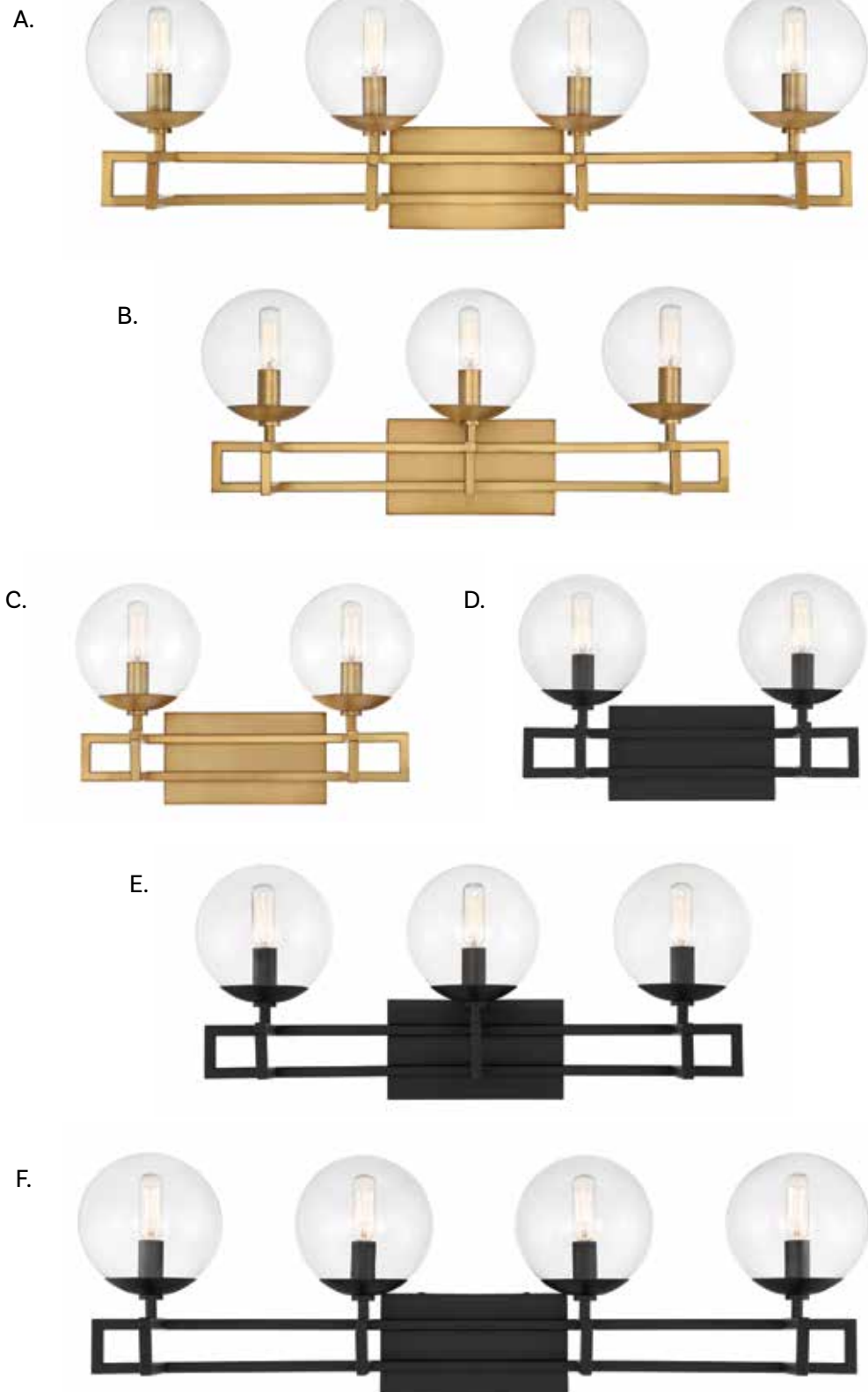

OCTAVE



Fixtures may be mounted either uplight or downlight.

OCTAVE

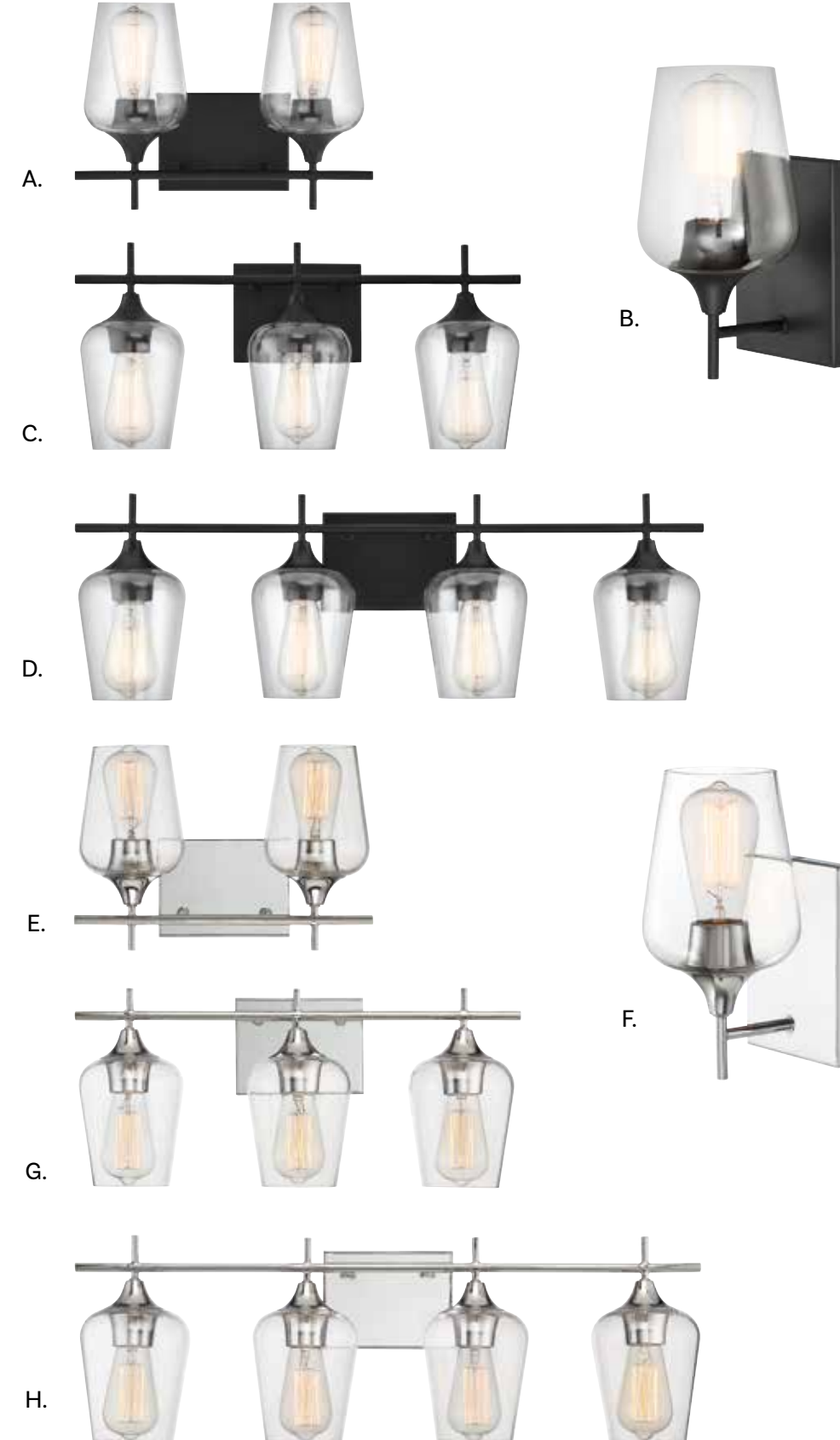

- A. 8-4030-2-BK**
2-Light Bath Bar
Matte Black Finish
13-3/4"W x 9"H x 5-1/2"E
2E 60W
Clear Glass
- B. 9-4030-1-BK**
1-Light Sconce
Matte Black Finish
5"W x 9-1/2"H x 6"E
1E 60W
Clear Glass
- C. 8-4030-3-BK**
3-Light Bath Bar
Matte Black Finish
21"W x 9"H x 5-1/2"E
3E 60W
Clear Glass
- D. 8-4030-4-BK**
4-Light Bath Bar
Matte Black Finish
28-3/4"W x 9"H x 5-1/2"E
4E 60W
Clear Glass
- E. 8-4030-2-11**
2-Light Bath Bar
Polished Chrome Finish
13-3/4"W x 9"H x 5-1/2"E
2E 60W
Clear Glass
- F. 9-4030-1-11**
1-Light Sconce
Polished Chrome Finish
5"W x 9-1/2"H x 6"E
1E 60W
Clear Glass
- G. 8-4030-3-11**
3-Light Bath Bar
Polished Chrome Finish
21"W x 9"H x 5-1/2"E
3E 60W
Clear Glass
- H. 8-4030-4-11**
4-Light Bath Bar
Polished Chrome Finish
28-3/4"W x 9"H x 5-1/2"E
4E 60W
Clear Glass

- A. 9-4030-1-13**
1-Light Sconce
English Bronze Finish
5"W x 9-1/2"H x 6"E
1E 60W
Clear Glass
- B. 8-4030-2-13**
2-Light Bath Bar
English Bronze Finish
13-3/4"W x 9"H x 5-1/2"E
2E 60W
Clear Glass
- C. 8-4030-3-13**
3-Light Bath Bar
English Bronze Finish
21"W x 9"H x 5-1/2"E
3E 60W
Clear Glass
- D. 8-4030-4-13**
4-Light Bath Bar
English Bronze Finish
28-3/4"W x 9"H x 5-1/2"E
4E 60W
Clear Glass
- E. 9-4030-1-322**
1-Light Sconce
Warm Brass Finish
5"W x 9-1/2"H x 6"E
1E 60W
Clear Glass
- F. 8-4030-2-322**
2-Light Bath Bar
Warm Brass Finish
13-3/4"W x 9"H x 5-1/2"E
2E 60W
Clear Glass
- G. 8-4030-3-322**
3-Light Bath Bar
Warm Brass Finish
21"W x 9"H x 5-1/2"E
3E 60W
Clear Glass
- H. 8-4030-4-322**
4-Light Bath Bar
Warm Brass Finish
28-3/4"W x 9"H x 5-1/2"E
4E 60W
Clear Glass



Fixtures may be mounted either uplight or downlight.

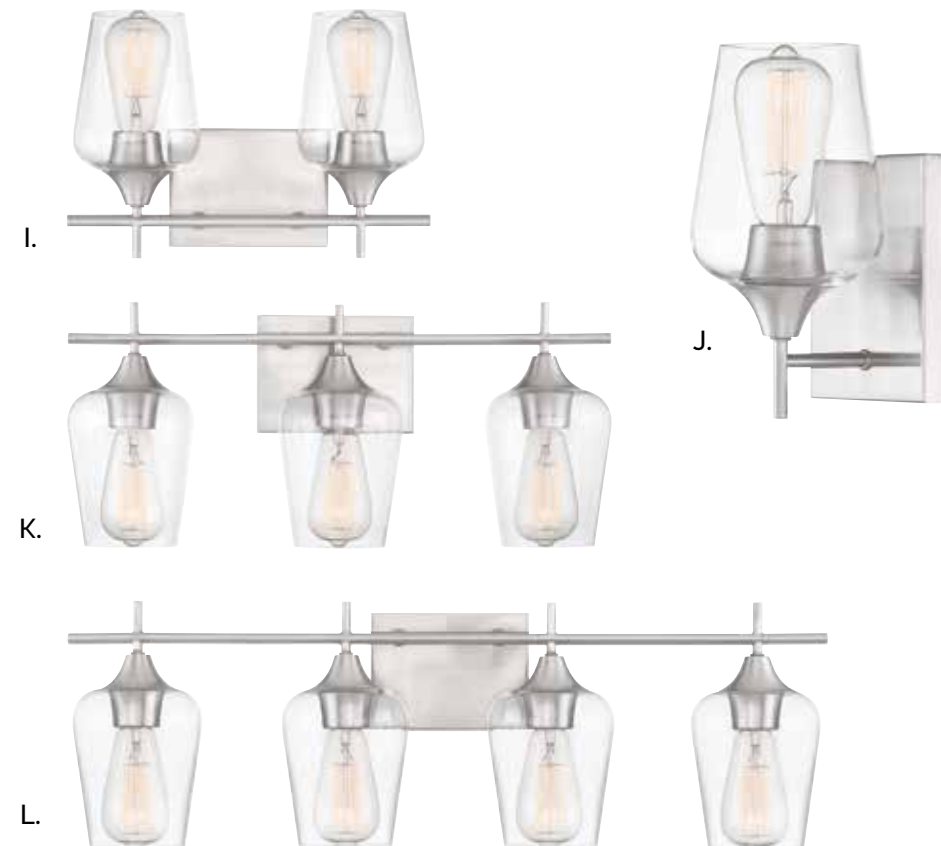

- I. 8-4030-2-SN**
2-Light Bath Bar
Satin Nickel Finish
13-3/4"W x 9"H x 5-1/2"E
2E 60W
Clear Glass
- J. 9-4030-1-SN**
1-Light Sconce
Satin Nickel Finish
5"W x 9-1/2"H x 6"E
1E 60W
Clear Glass
- K. 8-4030-3-SN**
3-Light Bath Bar
Satin Nickel Finish
21"W x 9"H x 5-1/2"E
3E 60W
Clear Glass
- L. 8-4030-4-SN**
4-Light Bath Bar
Satin Nickel Finish
28-3/4"W x 9"H x 5-1/2"E
4E 60W
Clear Glass



- A. 9-1830-1-89**
1-Light Sconce
Matte Black Finish
5-1/2"W x 9-1/2"H x 6-1/2"E
1E 60W
Clear Glass
- B. 8-1830-2-BK**
2-Light Bath Bar
Matte Black Finish
16"W x 9-1/2"H x 6-1/2"E
2E 60W
Clear Glass
- C. 8-1830-3-BK**
3-Light Bath Bar
Matte Black Finish
24"W x 9-1/2"H x 6-1/2"E
3E 60W
Clear Glass
- D. 8-1830-4-BK**
4-Light Bath Bar
Matte Black Finish
32"W x 9-1/2"H x 6-1/2"E
4E 60W
Clear Glass
- E. 8-1830-4-322**
4-Light Bath Bar
Warm Brass Finish
32"W x 9-1/2"H x 6-1/2"E
4E 60W
Clear Glass
- F. 8-1830-3-322**
3-Light Bath Bar
Warm Brass Finish
24"W x 9-1/2"H x 6-1/2"E
3E 60W
Clear Glass
- G. 9-1830-1-322**
1-Light Sconce
Warm Brass Finish
5-1/2"W x 9-1/2"H x 6-1/2"E
1E 60W
Clear Glass
- H. 8-1830-2-322**
2-Light Bath Bar
Warm Brass Finish
16"W x 9-1/2"H x 6-1/2"E
2E 60W
Clear Glass



- A. 8-9130-4-322**
4-Light Bath Bar
Warm Brass Finish
38"W x 10"H x 7-1/2"E
4E 60W
Clear Glass
- B. 8-9130-3-322**
3-Light Bath Bar
Warm Brass Finish
28-1/2"W x 10"H x 7-1/2"E
3E 60W
Clear Glass
- C. 8-9130-2-322**
2-Light Bath Bar
Warm Brass Finish
17-3/4"W x 10"H x 7-1/2"E
2E 60W
Clear Glass
- D. 8-9130-2-BK**
2-Light Bath Bar
Matte Black Finish
17-3/4"W x 10"H x 7-1/2"E
2E 60W
Clear Glass
- E. 8-9130-3-BK**
3-Light Bath Bar
Matte Black Finish
28-1/2"W x 10"H x 7-1/2"E
3E 60W
Clear Glass
- F. 8-9130-4-BK**
4-Light Bath Bar
Matte Black Finish
38"W x 10"H x 7-1/2"E
4E 60W
Clear Glass

Fixtures may be mounted either upright or downlight.



- | | | | | | |
|------------------------------------------------------------------------------------------------------------------------------|----------------------------------------------------------------------------------------------------------------------------------|----------------------------------------------------------------------------------------------------------------------------------|--------------------------------------------------------------------------------------------------------------------------------|--------------------------------------------------------------------------------------------------------------------------------|----------------------------------------------------------------------------------------------------------------------------|
| A. 8-9130-4-109
4-Light Bath Bar
Polished Nickel
Finish
38"W x 10"H x
7-1/2"E
4E 60W
Clear Glass | B. 8-9130-3-109
3-Light Bath Bar
Polished Nickel
Finish
28-1/2"W x 10"H x
7-1/2"E
3E 60W
Clear Glass | C. 8-9130-2-109
2-Light Bath Bar
Polished Nickel
Finish
17-3/4"W x 10"H x
7-1/2"E
2E 60W
Clear Glass | D. 8-9130-2-13
2-Light Bath Bar
English Bronze
Finish
17-3/4"W x 10"H x
7-1/2"E
2E 60W
Clear Glass | E. 8-9130-3-13
3-Light Bath Bar
English Bronze
Finish
28-1/2"W x 10"H x
7-1/2"E
3E 60W
Clear Glass | F. 8-9130-4-13
4-Light Bath Bar
English Bronze
Finish
38"W x 10"H x
7-1/2"E
4E 60W
Clear Glass |
|------------------------------------------------------------------------------------------------------------------------------|----------------------------------------------------------------------------------------------------------------------------------|----------------------------------------------------------------------------------------------------------------------------------|--------------------------------------------------------------------------------------------------------------------------------|--------------------------------------------------------------------------------------------------------------------------------|----------------------------------------------------------------------------------------------------------------------------|

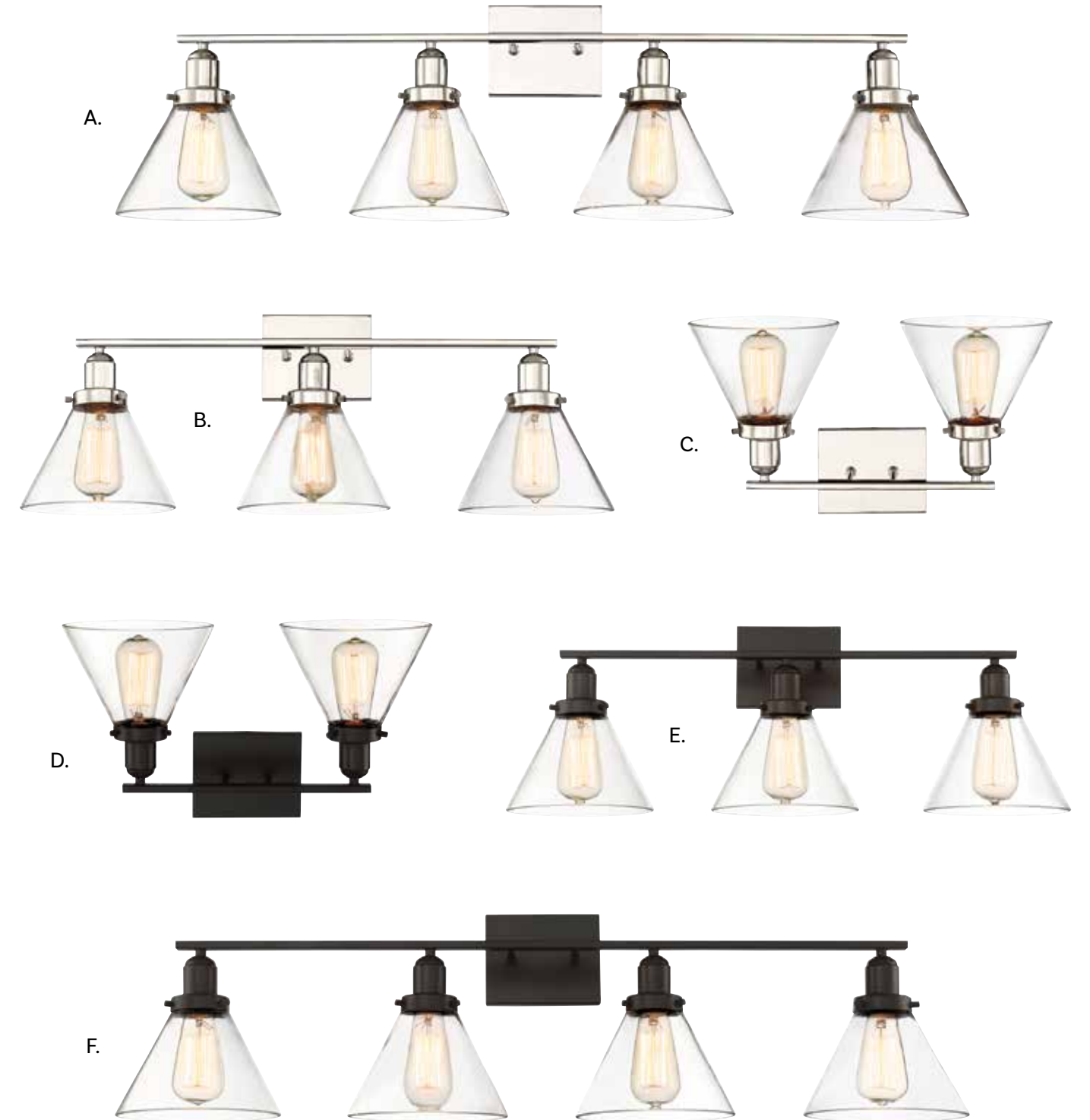

Fixtures may be mounted either uplight or downlight.



Fixtures may be mounted either uplight or downlight.



A.

- A. 8-8020-4-BK**
4-Light Bath Bar
Matte Black Finish
31"W x 9-1/2"H x 6-1/2"E
4E 60W
Clear Seeded Glass



B.

- B. 8-8020-3-BK**
3-Light Bath Bar
Matte Black Finish
22"W x 9-1/2"H x 6-1/2"E
3E 60W
Clear Seeded Glass



C.

- C. 8-8020-2-BK**
2-Light Bath Bar
Matte Black Finish
13-1/4"W x 9-1/2"H x 6-1/2"E
2E 60W
Clear Seeded Glass

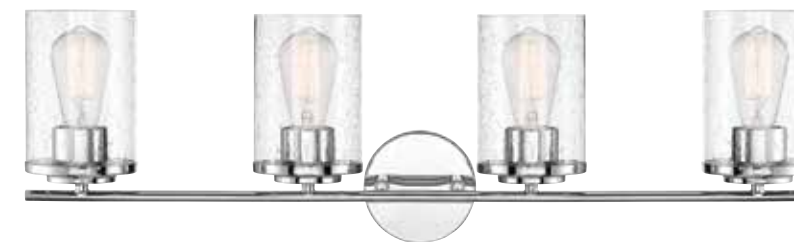

D.

- D. 8-8020-4-11**
4-Light Bath Bar
Polished Chrome Finish
31"W x 9-1/2"H x 6-1/2"E
4E 60W
Clear Seeded Glass



E.

- E. 8-8020-3-11**
3-Light Bath Bar
Polished Chrome Finish
22"W x 9-1/2"H x 6-1/2"E
3E 60W
Clear Seeded Glass



F.

- F. 8-8020-2-11**
2-Light Bath Bar
Polished Chrome Finish
13-1/4"W x 9-1/2"H x 6-1/2"E
2E 60W
Clear Seeded Glass



Fixtures may be mounted either uplight or downlight.



A.

- A. 8-7205-4-BK**
4-Light Bath Bar
Matte Black Finish
33"W x 9-3/4"H x 7-1/4"E
4E 60W
Clear Glass



B.

- B. 8-7205-3-BK**
3-Light Bath Bar
Matte Black Finish
24"W x 9-3/4"H x 7-1/4"E
3E 60W
Clear Glass



C.

- C. 8-7205-2-BK**
2-Light Bath Bar
Matte Black Finish
14-3/4"W x 9-3/4"H x 7-1/4"E
2E 60W
Clear Glass



D.

- D. 8-7205-4-SN**
4-Light Bath Bar
Satin Nickel Finish
33"W x 9-3/4"H x 7-1/4"E
4E 60W
Clear Glass

- E. 8-7205-3-SN**
3-Light Bath Bar
Satin Nickel Finish
24"W x 9-3/4"H x 7-1/4"E
3E 60W
Clear Glass



E.

- F. 8-7205-2-SN**
2-Light Bath Bar
Satin Nickel Finish
14-3/4"W x 9-3/4"H x 7-1/4"E
2E 60W
Clear Glass



F.

A. 8-4090-4-109
 4-Light Bath Bar
 Polished Nickel Finish
 31"W x 9"H x 6-1/2"E
 4E 60W
 White Opal Glass



A.

B. 8-4090-3-109
 3-Light Bath Bar
 Polished Nickel Finish
 22"W x 9"H x 6-1/2"E
 3E 60W
 White Opal Glass



B.

C. 8-4090-2-109
 2-Light Bath Bar
 Polished Nickel Finish
 15"W x 9"H x 6-1/2"E
 2E 60W
 White Opal Glass



C.

D. 8-4090-4-322
 4-Light Bath Bar
 Warm Brass Finish
 31"W x 9"H x 6-1/2"E
 4E 60W
 White Opal Glass



D.

E. 8-4090-3-322
 3-Light Bath Bar
 Warm Brass Finish
 22"W x 9"H x 6-1/2"E
 3E 60W
 White Opal Glass



E.

F. 8-4090-2-322
 2-Light Bath Bar
 Warm Brass Finish
 15"W x 9"H x 6-1/2"E
 2E 60W
 White Opal Glass



F.

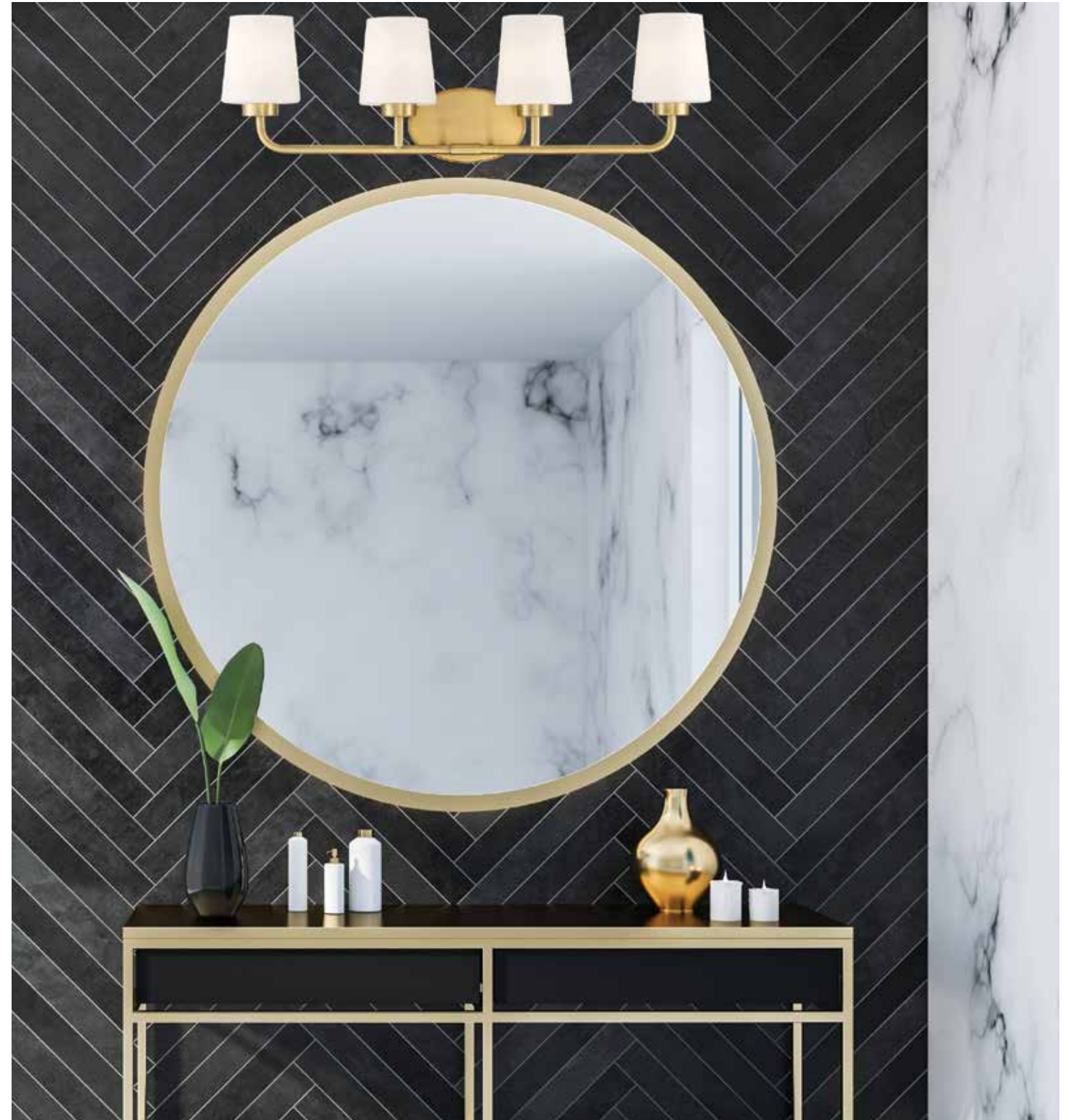

Fixtures may be mounted either upright or downlight.



Fixtures may be mounted either uplight or downlight

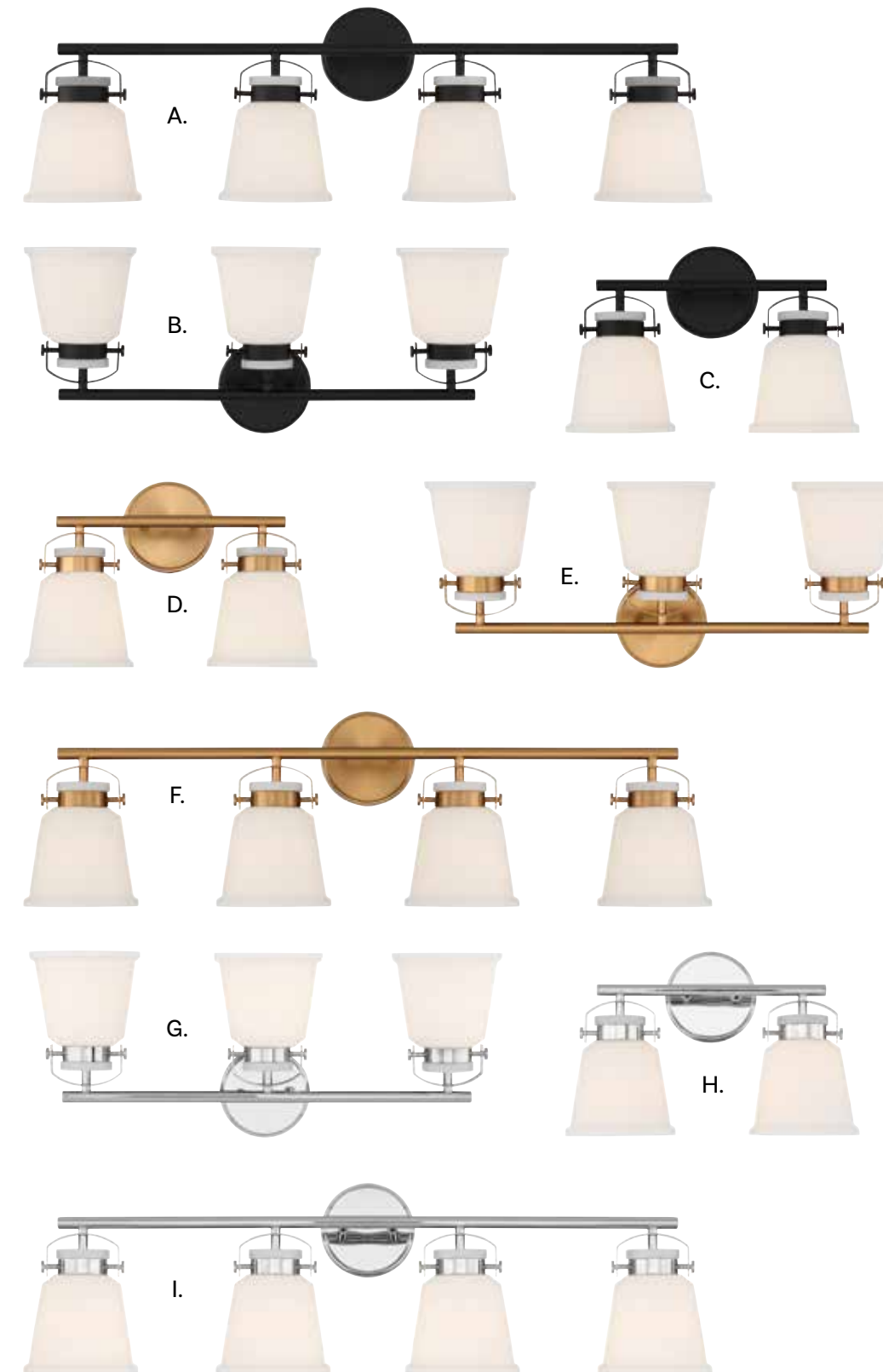

- A. 8-1627-4-BK**
4-Light Bath Bar
Matte Black Finish
34"W x 10-1/2"H x 7"E
4E 60W
White Opal Glass
- B. 8-1627-3-BK**
3-Light Bath Bar
Matte Black Finish
26"W x 10-1/2"H x 7"E
3E 60W
White Opal Glass
- C. 8-1627-2-BK**
2-Light Bath Bar
Matte Black Finish
16"W x 10-1/2"H x 7"E
2E 60W
White Opal Glass
- D. 8-1627-2-322**
2-Light Bath Bar
Warm Bath Bar
16"W x 10-1/2"H x 7"E
2E 60W
White Opal Glass
- E. 8-1627-3-322**
3-Light Bath Bar
Warm Brass Finish
26"W x 10-1/2"H x 7"E
3E 60W
White Opal Glass
- F. 8-1627-4-322**
4-Light Bath Bar
Warm Brass Finish
34"W x 10-1/2"H x 7"E
4E 60W
White Opal Glass
- G. 8-1627-3-11**
3-Light Bath Bar
Polished Chrome Finish
26"W x 10-1/2"H x 7"E
3E 60W
White Opal Glass
- H. 8-1627-2-11**
2-Light Bath Bar
Polished Chrome Finish
16"W x 10-1/2"H x 7"E
2E 60W
White Opal Glass
- I. 8-1627-4-11**
4-Light Bath Bar
Polished Chrome Finish
34"W x 10-1/2"H x 7"E
4E 60W
White Opal Glass

CAMERON



A. 8-2542-3-322
3-Light Bath Bar
Warm Brass Finish
24"W x 12"H x 8"E
3C 40W
White Fabric Shades
Metal Candle Covers

B. 9-2542-1-322
1-Light Sconce
Warm Brass Finish
5"W x 13"H x 8"E
1C 40W
White Fabric Shade
Metal Candle Cover

C. 8-2542-2-322
2-Light Bath Bar
Warm Brass Finish
15"W x 12"H x 8"E
2C 40W
White Fabric Shades
Metal Candle Covers

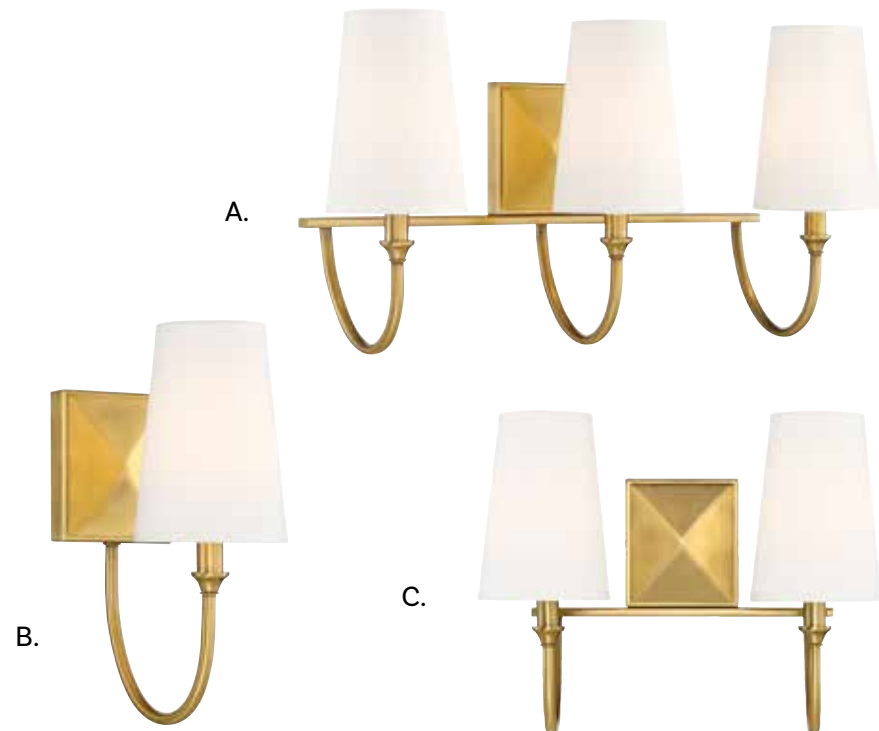

CAMERON



D.



E.



F.



G.



H.



I.

D. 8-2542-3-89
3-Light Bath Bar
Matte Black Finish
24"W x 12"H x 8"E
3C 40W
White Fabric Shades
Metal Candle Covers

E. 8-2542-2-89
2-Light Bath Bar
Matte Black Finish
15"W x 12"H x 8"E
2C 40W
White Fabric Shades
Metal Candle Covers

F. 9-2542-1-89
1-Light Sconce
Matte Black Finish
5"W x 13"H x 8"E
1C 40W
White Fabric Shade
Metal Candle Cover

G. 8-2542-3-109
3-Light Bath Bar
Polished Nickel Finish
24"W x 12"H x 8"E
3C 40W
White Fabric Shades
Metal Candle Covers

H. 8-2542-2-109
2-Light Bath Bar
Polished Nickel Finish
15"W x 12"H x 8"E
2C 40W
White Fabric Shades
Metal Candle Covers

I. 9-2542-1-109
1-Light Sconce
Polished Nickel Finish
5"W x 13"H x 8"E
1C 40W
White Fabric Shade
Metal Candle Cover

MELROSE



- A. 8-6836-2-322**
2-Light Bath Bar
Warm Brass Finish
14-1/2"W x 7-3/4"H x 6-3/4"E
2E 60W
White Opal Etched Glass
- B. 8-6836-3-322**
3-Light Bath Bar
Warm Brass Finish
24"W x 7-3/4"H x 6-3/4"E
3E 60W
White Opal Etched Glass
- C. 8-6836-4-322**
4-Light Bath Bar
Warm Brass Finish
33-1/2"W x 7-3/4"H x 6-3/4"E
4E 60W
White Opal Etched Glass
- D. 9-6836-1-322**
1-Light Sconce
Warm Brass Finish
5"W x 7-3/4"H x 6-3/4"E
1E 60W
White Opal Etched Glass

MELROSE



- E. 8-6836-2-SN**
2-Light Bath Bar
Satin Nickel Finish
14-1/2"W x 7-3/4"H x 6-3/4"E
2E 60W
White Opal Etched Glass
- F. 8-6836-3-SN**
3-Light Bath Bar
Satin Nickel Finish
24"W x 7-3/4"H x 6-3/4"E
3E 60W
White Opal Etched Glass
- G. 8-6836-4-SN**
4-Light Bath Bar
Satin Nickel Finish
33-1/2"W x 7-3/4"H x 6-3/4"E
4E 60W
White Opal Etched Glass
- H. 9-6836-1-SN**
1-Light Sconce
Satin Nickel Finish
5"W x 7-3/4"H x 6-3/4"E
1E 60W
White Opal Etched Glass

Fixtures may be mounted either upright or downlight.



A. 8-6836-2-13
2-Light Bath Bar
English Bronze Finish
14-1/2"W x 7-3/4"H x
6-3/4"E
2E 60W
White Opal Etched Glass

B. 8-6836-3-13
3-Light Bath Bar
English Bronze Finish
24"W x 7-3/4"H x 6-3/4"E
3E 60W
White Opal Etched Glass

C. 8-6836-4-13
4-Light Bath Bar
English Bronze Finish
33-1/2"W x 7-3/4"H x
6-3/4"E
4E 60W
White Opal Etched Glass

D. 9-6836-1-13
1-Light Sconce
English Bronze Finish
5"W x 7-3/4"H x 6-3/4"E
1E 60W
White Opal Etched Glass

E. 8-6836-2-11
2-Light Bath Bar
Polished Chrome Finish
14-1/2"W x 7-3/4"H x
6-3/4"E
2E 60W
White Opal Etched Glass

F. 8-6836-3-11
3-Light Bath Bar
Polished Chrome Finish
24"W x 7-3/4"H x 6-3/4"E
3E 60W
White Opal Etched Glass

G. 8-6836-4-11
4-Light Bath Bar
Polished Chrome Finish
33-1/2"W x 7-3/4"H x
6-3/4"E
4E 60W
White Opal Etched Glass

H. 9-6836-1-11
1-Light Sconce
Polished Chrome Finish
5"W x 7-3/4"H x 6-3/4"E
1E 60W
White Opal Etched Glass



Fixtures may be mounted either upright or downlight.



Fixtures may be mounted either uplight or downlight

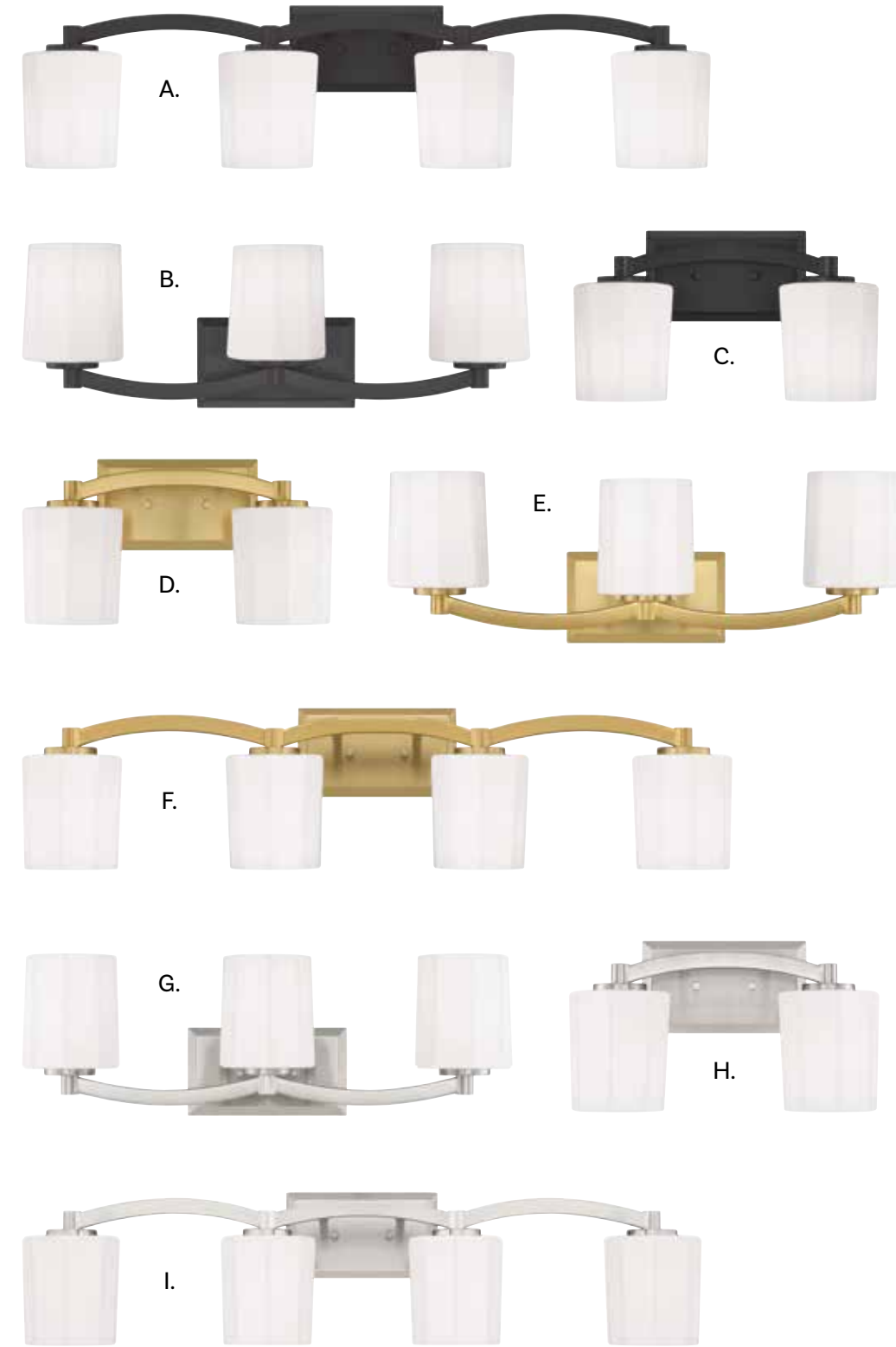

- A. 8-7710-4-BK**
4-Light Bath Bar
Matte Black Finish
33"W x 8"H x 6-1/2"E
4E 60W
Fluted Opal Etched Glass
- B. 8-7710-3-BK**
3-Light Bath Bar
Matte Black Finish
24"W x 8"H x 6-1/2"E
3E 60W
Fluted Opal Etched Glass
- C. 8-7710-2-BK**
2-Light Bath Bar
Matte Black Finish
14"W x 8"H x 6-1/2"E
2E 60W
Fluted Opal Etched Glass
- D. 8-7710-2-322**
2-Light Bath Bar
Warm Brass Finish
14"W x 8"H x 6-1/2"E
2E 60W
Fluted Opal Etched Glass
- E. 8-7710-3-322**
3-Light Bath Bar
Warm Brass Finish
24"W x 8"H x 6-1/2"E
3E 60W
Fluted Opal Etched Glass
- F. 8-7710-4-322**
4-Light Bath Bar
Warm Brass Finish
33"W x 8"H x 6-1/2"E
4E 60W
Fluted Opal Etched Glass
- G. 8-7710-3-SN**
3-Light Bath Bar
Satin Nickel Finish
24"W x 8"H x 6-1/2"E
3E 60W
Fluted Opal Etched Glass
- H. 8-7710-2-SN**
2-Light Bath Bar
Satin Nickel Finish
14"W x 8"H x 6-1/2"E
2E 60W
Fluted Opal Etched Glass
- I. 8-7710-4-SN**
4-Light Bath Bar
Satin Nickel Finish
33"W x 8"H x 6-1/2"E
4E 60W
Fluted Opal Etched Glass



Fixtures may be mounted either uplight or downlight.



A.



B.



C.

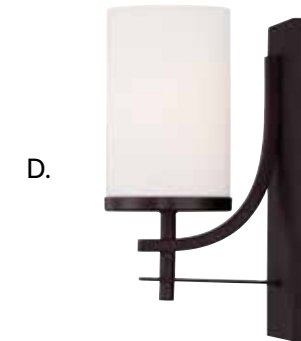

D.



E.



F.



G.



H.

- A. 8-338-2-13**
2-Light Bath Bar
English Bronze Finish
13-1/2"W x 9"H x 5"E
2E 60W
White Opal Glass
- B. 8-338-3-13**
3-Light Bath Bar
English Bronze Finish
20-1/2"W x 9"H x 5"E
3E 60W
White Opal Glass
- C. 8-338-4-13**
4-Light Bath Bar
English Bronze Finish
28-1/2"W x 9"H x 5"E
4E 60W
White Opal Glass
- D. 9-337-1-13**
1-Light Sconce
English Bronze Finish
4-3/4"W x 10"H x 6"E
1E 60W
White Opal Glass
- E. 9-337-1-SN**
1-Light Sconce
Satin Nickel Finish
4-3/4"W x 10"H x 6"E
1E 60W
White Opal Glass
- F. 8-338-2-SN**
2-Light Bath Bar
Satin Nickel Finish
13-1/2"W x 9"H x 5"E
2E 60W
White Opal Glass
- G. 8-338-3-SN**
3-Light Bath Bar
Satin Nickel Finish
20-1/2"W x 9"H x 5"E
3E 60W
White Opal Glass
- H. 8-338-4-SN**
4-Light Bath Bar
Satin Nickel Finish
28-1/2"W x 9"H x 5"E
4E 60W
White Opal Glass

HERNDON/YATES

A. HERNDON
9-1007-1-SN
 1-Light Sconce
 Satin Nickel Finish
 5-1/2"W x 10-3/4"H x 7-1/2"E
 1E 60W
 Frosted White Glass



A

B. HERNDON
8-1007-2-SN
 2-Light Bath Bar
 Satin Nickel Finish
 18"W x 8"H x 7-1/2"E
 2E 60W
 Frosted White Glass



B.

C. HERNDON
8-1007-3-SN
 3-Light Bath Bar
 Satin Nickel Finish
 24"W x 8"H x 7-1/2"E
 3E 60W
 Frosted White Glass



C.

D. HERNDON
8-1007-4-SN
 4-Light Bath Bar
 Satin Nickel Finish
 30"W x 8"H x 7-1/2"E
 4E 60W
 Frosted White Glass



D.

E. YATES
8-6837-4-69
 4-Light Bath Bar
 Pewter Finish
 31"W x 8-3/4"H x 7-1/2"E
 4E 60W
 White Glass

E.



F. YATES
8-6837-2-69
 2-Light Bath Bar
 Pewter Finish
 15"W x 8-3/4"H x 7-1/2"E
 2E 60W
 White Glass



F.

G. YATES
8-6837-3-69
 3-Light Bath Bar
 Pewter Finish
 22-3/4"W x 8-3/4"H x 7-1/2"E
 3E 60W
 White Glass



G.

ELISE/KANE

H.



I.



H. ELISE
8-9127-2-SN
 2-Light Bath Bar
 Satin Nickel Finish
 12-1/4"W x 10-1/8"H x 6-1/2"E
 2E 60W
 Frosted Opal Glass

I. ELISE
8-9127-1-SN
 1-Light Sconce
 Satin Nickel Finish
 4-1/2"W x 10-1/2"H x 6-1/2"E
 1E 60W
 Frosted Opal Glass

J.



J. ELISE
8-9127-3-SN
 3-Light Bath Bar
 Satin Nickel Finish
 20-1/2"W x 11"H x 6-1/2"E
 3E 60W
 Frosted Opal Glass

K. KANE
8-890-4-SN
 4-Light Bath Bar
 Satin Nickel Finish
 33"W x 8-1/2"H x 5-1/2"E
 4E 60W
 White Etched Glass

K.



L. KANE
8-890-3-SN
 3-Light Bath Bar
 Satin Nickel Finish
 24"W x 8-1/2"H x 5-1/2"E
 3E 60W
 White Etched Glass

L.



































































M.



















































M. KANE
8-890-2-SN
 2-Light Bath Bar
 Satin Nickel Finish
 16"W x 8-1/2"H x 5-1/2"E
 2E 60W
 White Etched Glass

FINISH GUIDE

	02 Oiled Bronze		62 Como Black w/ Gold		95 Warm Brass w/ Bronze Accents
	11 Polished Chrome		63 Warm Brass Lustre		96 Barrelwood w/ Brass Accents
	13 English Bronze		66 Matte Black w/ Satin Nickel		99 Provence
	21 Burnished Russet		67 Matte Black w/ Polished Chrome Accents		100 Aurora
	23 White Washed Driftwood		68 Whiskey Wood		101 Noblewood w/ Iron
	25 Slate		69 Pewter		109 Polished Nickel
	28 Oiled Burnished Bronze		70 Weathervane		110 Polished Chrome w/ Wooden Beads
	32 Artisan Rust		72 Rustic Bronze		111 Satin Nickel w/ Polished Nickel Accents
	36 Natural Walnut w/ Black Accents		76 Florencian Bronze		114 Britannia Gold
	38 Royal Gold		77 Bronze w/ Brass Accents		121 Mohican Bronze
	39 Fossil Stone		79 English Bronze & Warm Brass		124 Fiesta Bronze
	40 Walnut Patina		80 Matte White		127 Noble Brass
	41 Durango		81 Distressed White		128 Café
	44 Classic Bronze		82 Porcellana		129 Espresso
	45 Aged Wood		83 Bisque White		130 Aged Pewter
	46 Calypso		84 Rubbed Bronze W/ Gold Leaf		133 Sapele Finish
	47 White Cashmere		85 Rubbed Zinc w/ Silver Leaf		137 Textured Black w/ Warm Brass Accents
	50 Black Cashmere		88 Oxidized Black		139 Greywood w/ Pewter
	51 Vintage Black w/ Warm Brass Accents		89 Matte Black		142 White w/ Warm Brass Accents
	53 Silver Patina		90 Galvanized Metal		143 Black w/ Warm Brass Accents
	54 Gold Patina		92 Rumba		144 Matte Black w/ Burnished Brass Accents
	57 Polished Pewter		94 Avignon		

FINISH GUIDE

	150 Kenyon Black & Chrome		180 Matte Black w/ Dark Rattan		320 Warm Brass & Rope
	153 Black w/ Gold Highlights		181 Gunsmoke w/ Gray Rattan		322 Warm Brass
	154 Antique Nickel		182 Chelsea Gold		323 Old Bronze
	155 Provence w/ Gold Accents		183 Chelsea Walnut		BK Black
	160 White w/ Brass Accents		184 Grapevine		BZ Bronze
	161 Navy Blue w/ Warm Brass Accents		185 Lodge Finish		CH Chrome
	162 Aged Driftwood		187 Brushed Pewter		SN Satin Nickel
	165 Satin Nickel w/ Gray Wood		190 Forged Iron		WH White
	166 Black w/ Greywood		191 Darkwood w/ Black Accents		
	168 Galvanized Aluminum		193 Sweetgum		
	170 Burnished Brass w/ Walnut		194 Mesquite		
	171 Burnished Brass		195 Warm Brass w/ Chrome Accents		
	172 White w/ Polished Nickel Accents		196 Reclaimed Wood		
	173 Black w/ Polished Nickel Accents		198 Natural Antler		
	174 Navy w/ Polished Nickel Accents		211 Argentum		
	175 Gray w/ Polished Nickel Accents		212 Argentum & Gold		
	177 Burnished Brass w/ Natural Rattan		213 English Bronze w/ Gold		
	178 Aspen		242 Aged Steel		
	179 Mottled Zinc w/ Natural Rattan		260 True Gold		
			261 Matte Black w/ True Gold		
			272 Silver Dust		
			307 Silver Sparkle		

Savoy House mini-pendants are supplied with three 9-1/2" extension rods.

INDEX

1-1000-3-SN.....111	1-190-5-109.....125	1-326-3-322.....126	1-7000-6-322.....68
1-1001-5-SN.....111	1-190-5-322.....125	1-326-3-44.....126	1-7000-6-77.....69
1-1008-5-SN.....111	1-190-5-89.....125	1-327-5-322.....126	1-7000-6-89.....68
1-1021-5-322.....103	1-190-5-SN.....125	1-327-5-44.....126	1-7001-12-109.....71
1-1021-5-89.....101	1-2450-6-322.....78	1-330-5-SN.....109	1-7001-12-322.....70
1-1021-5-SN.....102	1-2450-6-89.....78	1-4032-5-11.....107	1-7001-12-77.....71
1-1023-5-322.....103	1-2451-8-322.....78	1-4032-5-13.....107	1-7001-12-89.....70
1-1023-5-89.....101	1-2451-8-89.....78	1-4032-5-322.....105	1-8200-5-109.....11
1-1023-5-SN.....102	1-2520-6-322.....80	1-4032-5-BK.....105	1-8200-5-322.....11
1-1613-4-322.....31	1-2520-6-89.....80	1-4032-5-SN.....106	1-8200-5-89.....11
1-1613-4-89.....31	1-2540-5-109.....91	1-4033-9-BK.....105	1-8203-3-109.....13
1-1614-3-322.....33	1-2540-5-322.....91	1-4033-9-SN.....106	1-8203-3-322.....13
1-1614-3-89.....33	1-2540-5-89.....91	1-423-3-322.....121	1-8203-3-89.....13
1-1623-6-322.....41	1-2541-9-109.....93	1-423-3-89.....121	1-9772-10-322.....24
1-1623-6-89.....41	1-2541-9-322.....93	1-424-5-109.....123	1-9772-10-89.....23
1-1624-8-322.....39	1-2541-9-89.....93	1-424-5-322.....123	1-9773-12-322.....24
1-1624-8-89.....39	1-2802-6-322.....36	1-424-5-44.....123	1-9773-12-89.....23
1-1630-5-143.....83	1-2802-6-89.....35	1-424-5-89.....123	24-FD-8853-322.....20
1-1630-5-173.....83	1-2803-5-322.....36	1-424-5-SN.....123	24-FD-8853-89.....20
1-1631-6-143.....84	1-2803-5-89.....35	1-4404-8-322.....63	27-FD-8201-109.....14
1-1631-6-173.....84	1-307-6-322.....55	1-4404-8-89.....63	27-FD-8201-322.....14
1-1756-6-109.....89	1-307-6-89.....55	1-4405-10-322.....64	27-FD-8201-89.....14
1-1756-6-322.....89	1-3073-5-11.....45	1-4405-10-89.....64	3-1617-4-11.....148
1-1756-6-89.....89	1-3073-5-322.....44	1-4406-15-322.....67	3-1617-4-322.....148
1-1785-6-322.....87	1-3073-5-89.....43	1-4406-15-89.....66	3-1617-4-89.....148
1-1785-6-89.....87	1-3074-8-11.....45	1-4410-5-109.....75	3-2226-8-322.....9
1-1786-5-322.....87	1-3074-8-322.....44	1-4410-5-322.....75	3-2226-8-89.....9
1-1786-5-89.....87	1-3074-8-89.....43	1-4410-5-89.....75	3-420-3-109.....112
1-1832-5-322.....50	1-308-8-322.....56	1-4412-8-109.....77	3-420-3-322.....112
1-1832-5-89.....52	1-308-8-44.....56	1-4412-8-322.....77	3-420-3-44.....112
1-1833-6-322.....50	1-308-8-89.....56	1-4412-8-89.....77	3-420-3-89.....112
1-1833-6-89.....52	1-308-8-SN.....56	1-5407-5-322.....27	3-420-3-SN.....112
1-1861-8-322.....49	1-310-10-322.....59	1-5407-5-89.....28	3-421-4-109.....115
1-1861-8-89.....49	1-310-10-89.....59	1-5409-5-322.....27	3-421-4-322.....115
1-1862-8-322.....46	1-312-15-322.....61	1-5409-5-89.....28	3-421-4-44.....115
1-1862-8-89.....46	1-312-15-89.....61	1-7000-6-109.....69	3-421-4-89.....115

INDEX

3-421-4-SN.....115	6-1802-3-SN.....99	6-6835-2-SN.....208	7-1040-3-BK.....137
3-422-6-322.....117	6-1950-6-322.....191	6-7003-8-109.....194	7-1040-3-SN.....137
3-422-6-44.....117	6-1950-6-89.....191	6-7003-8-322.....194	7-1041-6-109.....135
3-422-6-89.....117	6-1951-6-322.....191	6-7003-8-77.....194	7-1041-6-13.....135
3-422-6-SN.....117	6-1953-4-109.....188	6-7003-8-89.....194	7-1041-6-BK.....135
3-4901-4-322.....132	6-1953-4-322.....188	6-7200-1-322.....178, 207	7-1041-6-SN.....135
3-4901-4-89.....132	6-1953-4-89.....188	6-7200-1-89.....178, 207	7-130-1-44.....184
3-6612-4-322.....129	6-328-4-109.....119	6-7200-1-SN.....178, 207	7-130-1-63.....184
3-6612-4-89.....129	6-328-4-322.....119	6-7702-3-322.....130, 205	7-130-1-SN.....184
3-6612-4-SN.....129	6-328-4-44.....119	6-7702-3-89.....130, 205	7-170-1-11.....157
3-7700-3-322.....130	6-328-4-89.....119	6-7702-3-SN.....130, 205	7-170-1-322.....157
3-7700-3-89.....130	6-328-4-SN.....119	6-7790-3-322.....203	7-170-1-89.....157
3-7701-5-322.....130	6-3350-14-109.....198	6-7790-3-89.....203	7-1742-1-109.....176
3-7701-5-89.....130	6-3350-14-13.....198	6-7790-3-SN.....203	7-1742-1-322.....176
3-7701-5-SN.....130	6-3350-14-322.....199	6-780-11-13.....209	7-1742-1-89.....176
6-1005-3-SN.....111	6-3350-14-SN.....199	6-780-11-322.....209	7-180-1-109.....167
6-1024-3-322.....206	6-3350-16-109.....198	6-780-11-BK.....209	7-180-1-322.....167
6-1024-3-89.....206	6-3350-16-13.....198	6-780-11-SN.....209	7-180-1-89.....167
6-1024-3-SN.....206	6-3350-16-322.....199	6-780-13-13.....209	7-180-1-SN.....167
6-1043-3-109.....136, 206	6-3350-16-SN.....199	6-780-13-322.....209	7-1803-3-322.....97
6-1043-3-13.....136, 206	6-3750-1-322.....144, 207	6-780-13-BK.....209	7-1803-3-89.....97
6-1043-3-BK.....136	6-3750-1-89.....144, 207	6-780-13-SN.....209	7-1803-3-SN.....97
6-1043-3-SN.....137, 206	6-4035-3-11.....201	7-1003-3-SN.....111	7-1804-4-322.....97
6-133-16-109.....196	6-4035-3-13.....201	7-1004-3-SN.....111	7-1804-4-89.....97
6-133-16-322.....196	6-4035-3-322.....201	7-1010-1-SN.....185	7-1804-4-SN.....97
6-134-3-109.....196	6-4035-3-BK.....201	7-1025-3-322.....103	7-1831-1-322.....50, 177
6-134-3-322.....196	6-4035-3-SN.....201	7-1025-3-89.....101	7-1831-1-89.....52, 177
6-134-3-44.....196	6-4037-1-11.....200	7-1025-3-SN.....102	7-1875-3-11.....165
6-1679-5-322.....193	6-4037-1-13.....200	7-1026-1-322.....183	7-1875-3-13.....165
6-1679-5-89.....193	6-4037-1-322.....200	7-1026-1-89.....183	7-1875-3-322.....165
6-1679-5-SN.....193	6-4037-1-BK.....200	7-1026-1-SN.....183	7-1875-3-89.....165
6-1802-3-322.....99	6-4037-1-SN.....200	7-1027-1-322.....183	7-200-3-322.....169
6-1802-3-89.....99	6-4900-4-322.....132, 204	7-1027-1-89.....183	7-200-3-57.....169
	6-4900-4-89.....132, 204	7-1027-1-SN.....183	7-2201-4-13.....163
	6-6835-2-13.....208	7-1040-3-109.....136	7-2201-4-322.....163
		7-1040-3-13.....136	7-2201-4-SN.....163

INDEX

7-2224-5-322.....9	7-4034-3-322.....105	7-8840-1-SN.....161	8-1020-3-SN.....253
7-2224-5-89.....9	7-4034-3-BK.....105	7-8855-1-322.....17	8-1020-4-322.....253
7-2255-1-322.....153	7-4034-3-SN.....106	7-8855-1-89.....17	8-1020-4-BK.....253
7-2255-1-89.....153	7-4036-1-11.....187	7-8857-5-322.....17	8-1020-4-SN.....253
7-2255-1-SN.....153	7-4036-1-13.....187	7-8857-5-89.....17	8-1627-2-11.....285
7-2265-1-322.....155	7-4036-1-322.....187	7-8859-8-322.....19	8-1627-2-322.....285
7-2265-1-89.....155	7-4036-1-BK.....187	7-8859-8-89.....19	8-1627-2-BK.....285
7-2265-1-SN.....155	7-4036-1-SN.....187	7-9006-3-13.....173	8-1627-3-11.....285
7-231-1-109.....142	7-4134-1-13.....185	7-9006-3-322.....173	8-1627-3-322.....285
7-231-1-322.....142	7-4134-1-SN.....185	7-9006-3-89.....173	8-1627-3-BK.....285
7-231-1-323.....142	7-4499-1-109.....146	7-9006-3-SN.....173	8-1627-4-11.....285
7-231-1-89.....142	7-4499-1-322.....146	7-9044-3-322.....5	8-1627-4-322.....285
7-232-1-109.....142	7-4499-1-89.....146	7-9044-3-89.....5	8-1627-4-BK.....285
7-232-1-322.....142	7-5012-1-109.....168	7-9046-4-322.....5	8-1745-2-109.....251
7-232-1-323.....142	7-5012-1-13.....168	7-9046-4-89.....5	8-1745-2-322.....251
7-232-1-89.....142	7-5012-1-322.....168	7-9048-6-322.....7	8-1745-2-BK.....250
7-2521-4-322.....80	7-6099-24-109.....138	7-9048-6-89.....7	8-1745-3-109.....251
7-2521-4-89.....80	7-6099-24-322.....138	7-9063-1-67.....170	8-1745-3-322.....251
7-3075-1-11.....181	7-6099-24-89.....138	7-9063-1-95.....170	8-1745-3-BK.....251
7-3075-1-322.....181	7-700-1-109.....186	7-9064-1-67.....170	8-1745-4-109.....251
7-3075-1-89.....181	7-7006-1-322.....151	7-9064-1-95.....170	8-1745-4-322.....251
7-3100-1-322.....169	7-7006-1-89.....151	7-9132-1-109.....174	8-1745-4-BK.....251
7-3102-1-322.....169	7-7006-1-SN.....151	7-9132-1-13.....174	8-1830-2-322.....273
7-336-1-SN.....109	7-701-1-SN.....186	7-9132-1-322.....174	8-1830-2-BK.....273
7-3390-1-322.....181	7-702-1-109.....186	7-9132-1-89.....174	8-1830-3-322.....273
7-3390-1-89.....181	7-702-1-13.....186	7-9132-1-SN.....174	8-1830-3-BK.....273
7-3751-1-109.....145	7-703-1-SN.....186	7-9770-1-322.....24	8-1830-4-322.....273
7-3751-1-13.....145	7-7201-1-322.....178	7-9770-1-89.....23	8-1830-4-BK.....273
7-3751-1-322.....145	7-7201-1-89.....178	8-1007-2-SN.....296	8-1860-2-322.....266
7-3751-1-89.....145	7-7201-1-SN.....178	8-1007-3-SN.....296	8-1860-2-BK.....266
7-3751-1-SN.....145	7-730-1-109.....185	8-1007-4-SN.....296	8-1860-3-322.....266
7-3901-3-109.....158	7-8801-3-109.....140	8-1020-2-322.....253	8-1860-3-BK.....266
7-3901-3-322.....158	7-8801-3-322.....140	8-1020-2-BK.....253	8-1860-4-322.....266
7-3901-3-89.....158	7-8801-3-89.....140	8-1020-2-SN.....253	8-1860-4-BK.....266
7-4034-3-11.....107	7-8840-1-322.....161	8-1020-3-322.....253	8-2542-2-109.....287
7-4034-3-13.....107	7-8840-1-89.....161	8-1020-3-BK.....253	8-2542-2-322.....286

INDEX

8-2542-2-89.....287	8-4030-4-BK.....269	8-6001-4-322.....248	8-7710-3-BK.....293
8-2542-3-109.....287	8-4030-4-SN.....271	8-6001-4-BK.....249	8-7710-3-SN.....293
8-2542-3-322.....286	8-4050-2-322.....263	8-6836-2-11.....291	8-7710-4-322.....293
8-2542-3-89.....287	8-4050-2-BK.....263	8-6836-2-13.....290	8-7710-4-BK.....293
8-2603-4-BK.....259	8-4050-2-SN.....262	8-6836-2-322.....288	8-7710-4-SN.....293
8-2603-4-CH.....259	8-4050-3-322.....263	8-6836-2-SN.....289	8-8020-2-11.....279
8-2603-6-BK.....259	8-4050-3-BK.....263	8-6836-3-11.....291	8-8020-2-BK.....279
8-2603-6-CH.....259	8-4050-3-SN.....262	8-6836-3-13.....290	8-8020-3-11.....279
8-3076-2-11.....265	8-4050-4-322.....263	8-6836-3-322.....288	8-8020-3-BK.....279
8-3076-2-322.....265	8-4050-4-BK.....263	8-6836-3-SN.....289	8-8020-4-11.....279
8-3076-2-BK.....265	8-4050-4-SN.....262	8-6836-4-11.....291	8-8020-4-BK.....279
8-3076-3-11.....265	8-4090-2-109.....282	8-6836-4-13.....290	8-890-2-SN.....297
8-3076-3-322.....265	8-4090-2-322.....282	8-6836-4-322.....288	8-890-3-SN.....297
8-3076-3-BK.....265	8-4090-3-109.....282	8-6836-4-SN.....289	8-890-4-SN.....297
8-3076-4-11.....265	8-4090-3-322.....282	8-6837-2-69.....296	8-9127-1-SN.....247, 297
8-3076-4-322.....265	8-4090-4-109.....282	8-6837-3-69.....296	8-9127-2-SN.....297
8-3076-4-BK.....265	8-4090-4-322.....282	8-6837-4-69.....296	8-9127-3-SN.....297
8-338-2-13.....295	8-4300-2-BK.....261	8-7045-2-322.....257	8-9130-2-109.....276
8-338-2-SN.....295	8-4300-2-SN.....261	8-7045-2-BK.....257	8-9130-2-13.....276
8-338-3-13.....295	8-4300-3-BK.....261	8-7045-2-SN.....257	8-9130-2-322.....275
8-338-3-SN.....295	8-4300-3-SN.....261	8-7045-3-322.....257	8-9130-2-BK.....275
8-338-4-13.....295	8-4300-4-BK.....261	8-7045-3-BK.....257	8-9130-3-109.....276
8-338-4-SN.....295	8-4300-4-SN.....261	8-7045-3-SN.....257	8-9130-3-13.....276
8-4030-2-11.....269	8-5606-2-BK.....255	8-7045-4-322.....257	8-9130-3-322.....275
8-4030-2-13.....270	8-5606-2-SN.....255	8-7045-4-BK.....257	8-9130-3-BK.....275
8-4030-2-322.....270	8-5606-3-BK.....255	8-7045-4-SN.....257	8-9130-4-109.....276
8-4030-2-BK.....269	8-5606-3-SN.....255	8-7205-2-BK.....281	8-9130-4-13.....276
8-4030-2-SN.....271	8-5606-4-BK.....255	8-7205-2-SN.....281	8-9130-4-322.....275
8-4030-3-11.....269	8-5606-4-SN.....255	8-7205-3-BK.....281	8-9130-4-BK.....275
8-4030-3-13.....270	8-6001-2-109.....249	8-7205-3-SN.....281	9-0700-1-109.....225
8-4030-3-322.....270	8-6001-2-322.....249	8-7205-4-BK.....281	9-0700-1-322.....225
8-4030-3-BK.....269	8-6001-2-BK.....249	8-7205-4-SN.....281	9-0700-1-SN.....225
8-4030-3-SN.....271	8-6001-3-109.....249	8-7710-2-322.....293	9-0900CP-1-109.....243
8-4030-4-11.....269	8-6001-3-322.....249	8-7710-2-BK.....293	9-0900CP-1-13.....243
8-4030-4-13.....270	8-6001-3-BK.....249	8-7710-2-SN.....293	9-0900CP-1-322.....243
8-4030-4-322.....270	8-6001-4-109.....249	8-7710-3-322.....293	9-0900CP-1-89.....243

INDEX

9-0900CP-1-SN243	9-1801-1-89237	9-4030-1-13247, 270	9-900-1-322233
9-0901-1-109238	9-1801-1-SN237	9-4030-1-322247, 270	9-900-1-44233
9-0901-1-322238	9-1830-1-322273	9-4030-1-BK247, 269	9-9131CP-1-109245
9-0901-1-44238	9-1830-1-89273	9-4030-1-SN247, 271	9-9131CP-1-13245
9-0901-1-89238	9-1911-1-11213	9-4050-1-322247, 263	9-9131CP-1-322245
9-0901-1-SN238	9-1911-1-322213	9-4050-1-BK247, 263	9-9131CP-1-89245
9-0902-1-109226	9-1911-1-89213	9-4050-1-SN247, 262	9-9131CP-1-SN245
9-0902-1-322226	9-1914-1-322212	9-5201-1-322217	9-960-1-109244
9-0902-1-89226	9-1914-1-89212	9-5201-1-83217	9-960-1-13244
9-1007-1-SN ...111, 246, 296	9-1916-1-11235	9-5201-1-89217	9-960-1-322244
9-101-1-109219	9-1916-1-322235	9-5202-2-322217	9-960-1-89244
9-101-1-322219	9-1916-1-89235	9-5202-2-83217	9-960-1-SN244
9-101-1-89218	9-1918-1-150234	9-5202-2-89217	9-961CP-1-109242
9-101-1-SN218	9-1918-1-77234	9-5405-1-32227	9-961CP-1-13242
9-103-2-109219	9-1972-1-322246	9-5405-1-8928	9-961CP-1-322242
9-103-2-322218	9-2542-1-109224, 287	9-6001-1-109248	9-961CP-1-89242
9-103-2-89219	9-2542-1-322224, 286	9-6001-1-322248	9-961CP-1-SN242
9-103-2-SN218	9-2542-1-89224, 287	9-6001-1-89248	9-9771-2-32224
9-108-1-322240	9-2801-1-32236	9-6520-1-109211	9-9771-2-8923
9-108-1-89240	9-2801-1-8935	9-6520-1-322211	9-996-1-109230
9-108-1-SN240	9-302-1-109223	9-6520-1-89211	9-996-1-322230
9-1200-1-109239	9-302-1-322222	9-6836-1-11246, 291	9-996-1-89230
9-1200-1-322239	9-302-1-44222	9-6836-1-13246, 290	9-996-1-SN230
9-1200-1-89239	9-302-1-89221	9-6836-1-322246, 288	9-998-2-109214
9-1200-1-SN239	9-302-1-SN221	9-6836-1-SN246, 289	9-998-2-322214
9-16000-1-109232	9-303-1-109223	9-7005-1-322236	9-998-2-44214
9-16000-1-322232	9-303-1-322222	9-7005-1-89236	9-998-2-89214
9-16000-1-44232	9-303-1-44222	9-7005-1-SN236	9-998-2-SN214
9-1615-1-32231	9-303-1-89221	9-7140-1-322227	
9-1615-1-8931	9-303-1-SN221	9-7140-1-SN227	
9-1632-1-14383	9-3076-1-11264	9-7144-1-109223	
9-1632-1-17383	9-3076-1-322264	9-7144-1-322222	
9-1755-1-109229	9-3076-1-89264	9-7144-1-44222	
9-1755-1-322229	9-337-1-13246, 295	9-7144-1-89221	
9-1755-1-89229	9-337-1-SN246, 295	9-7144-1-SN221	
9-1801-1-322237	9-4030-1-11247, 269	9-900-1-109233	





3130 North Berkeley Lake Road NW | Duluth, GA 30096
TEL 800 801 1621 TEL 404 890 7540 FAX 877 547 2869

SAVOYHOUSE.COM

E08