

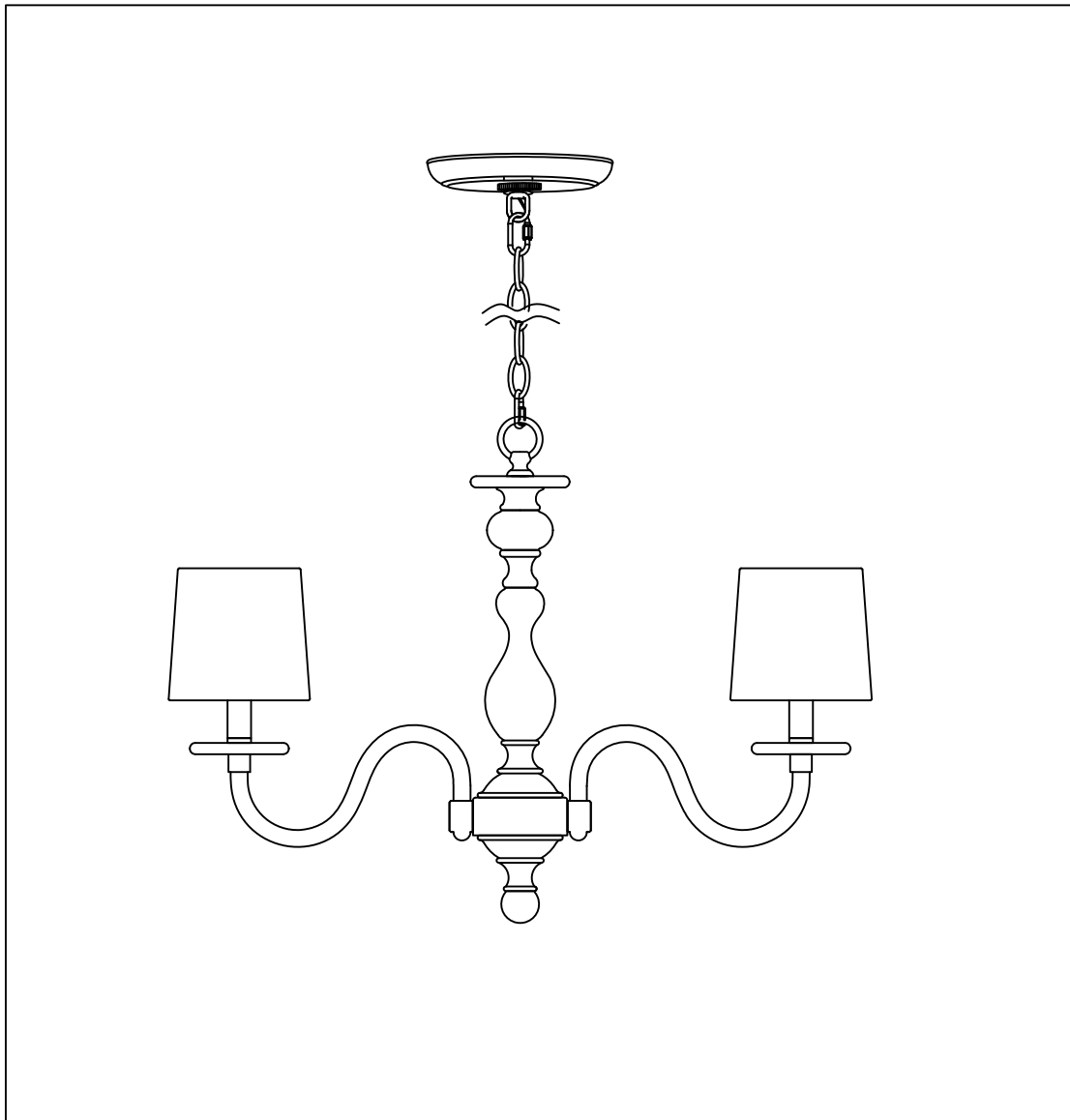

PRODUCT NAME: Venezia
ITEM NUMBER: 27546

Please consult your electrician for hanging fixture and wiring.



Bulb(not included): 6 x 40W E12 Candelabra Bulb

IMPORTANT: Turn OFF the power at the main fuse or circuit breaker box before starting installation

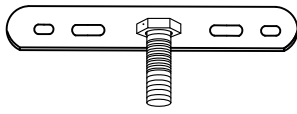

A
Mounting Hardware



B
Canopy



C
Screw Ring

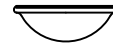

D
Bottom Cap



E
Finial

Locate all hardware & components before discarding packaging

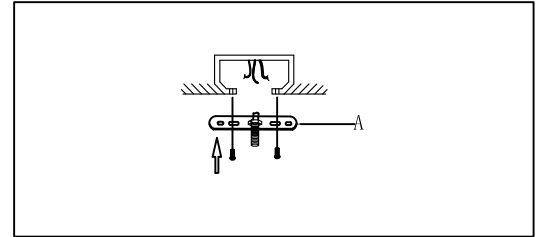
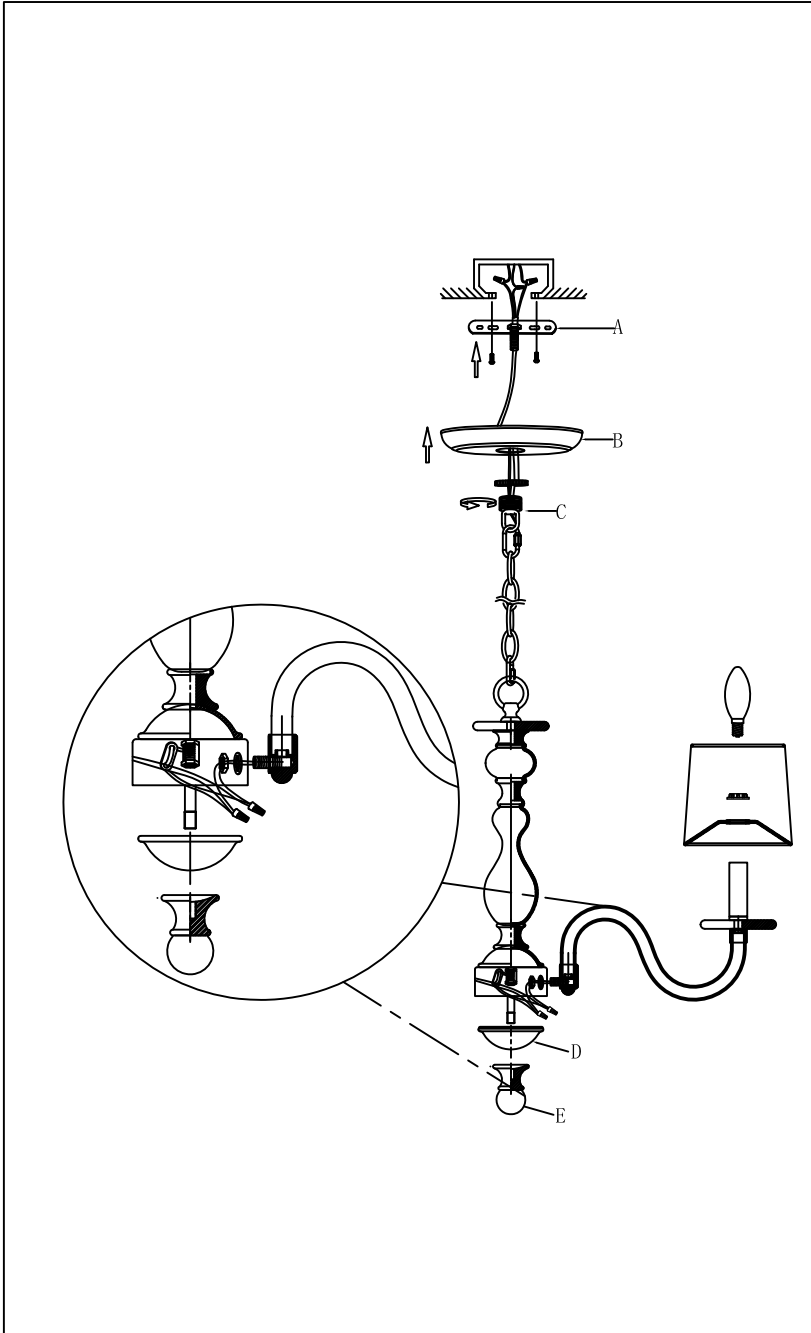

1.)

Step.1: Remove mounting bracket (A) from canopy (B) and install to electrical box.

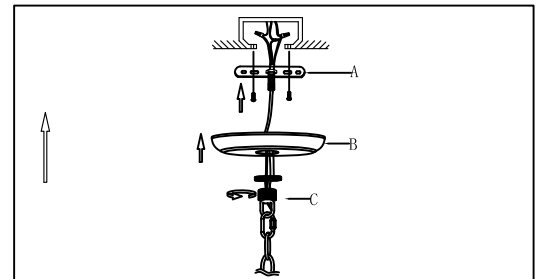

2.)

Step.2: Attach appropriate amount of chain to loop to achieve desired mounting height. Thread wire through every 3rd loop of chain. Remove ring from loop and slide down chain. Place canopy (B) onto chain and let slide to top of fixture. Install nipple and cross bar into top of chain loop. Wire fixture to wires in outlet box. Copper wire is for Ground. Pull canopy through screw ring (C) up chain to ceiling and tighten securely.

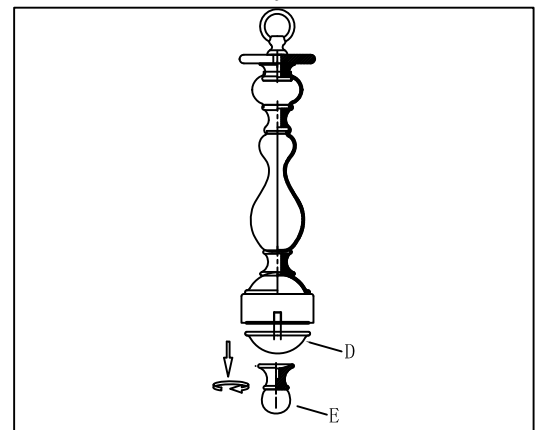

3.)

Step.3: Remove bottom assembly (D) & (E).

Cleaning & Care:

Clean with soft cloth and a mild detergent.
Do not use abrasive cleaner.

IMPORTANT: Turn OFF the power at the main fuse or circuit breaker box before starting installation



D
Bottom Cap



E
Finial

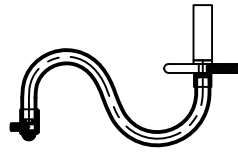

F
Arm

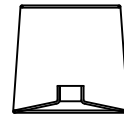

G
Shade

Locate all hardware & components before discarding packaging

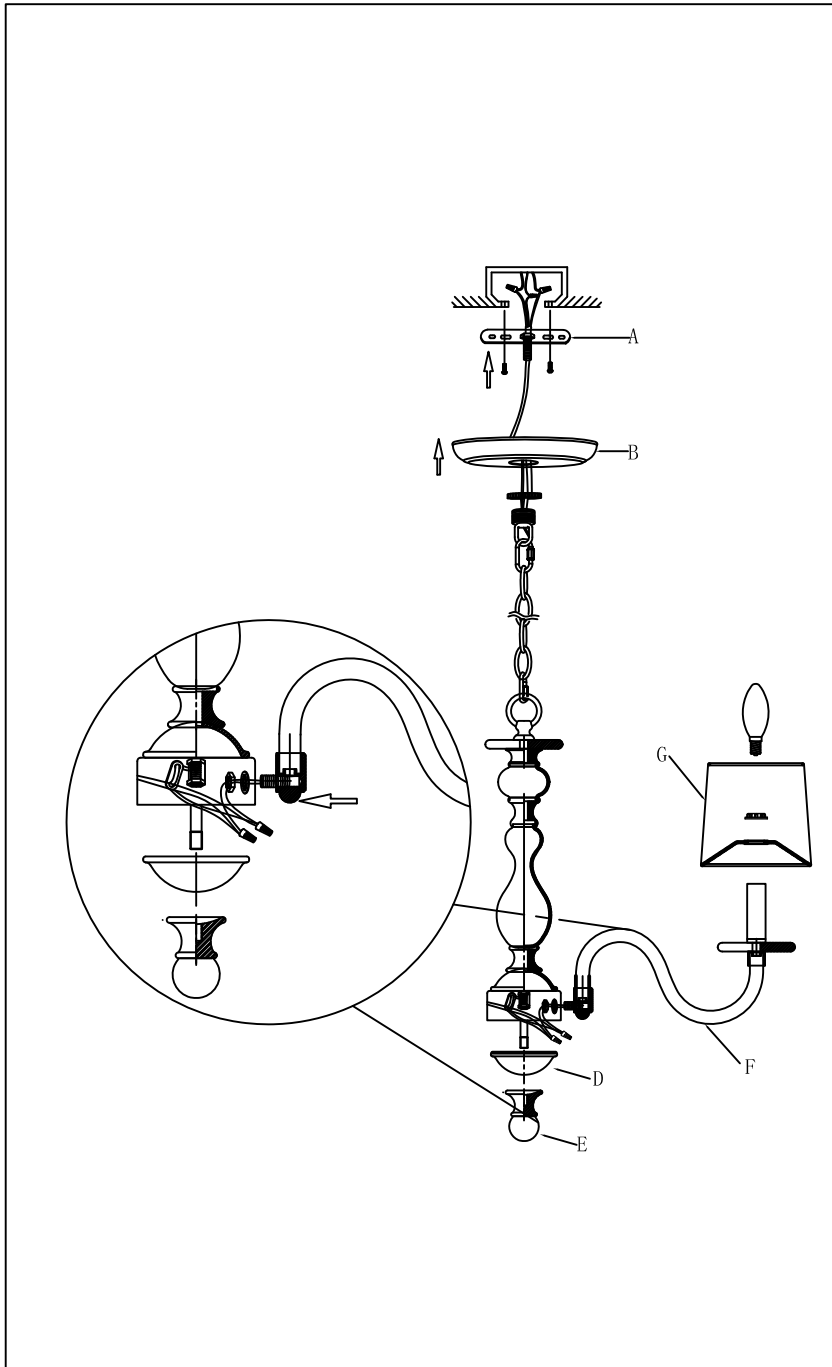

4.)

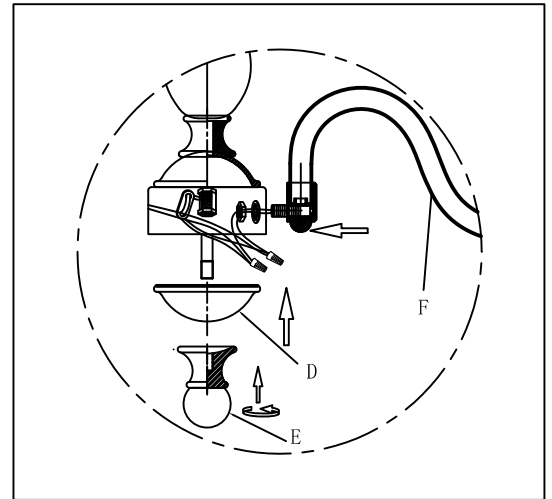

Step.4: Attach arms (F) using washer and nut provided. Then wire arm to the body of the fixture.
After all 6 arms are secured and wired, re-attach bottom cap (D) using finial (E).

3.)

Step.3:

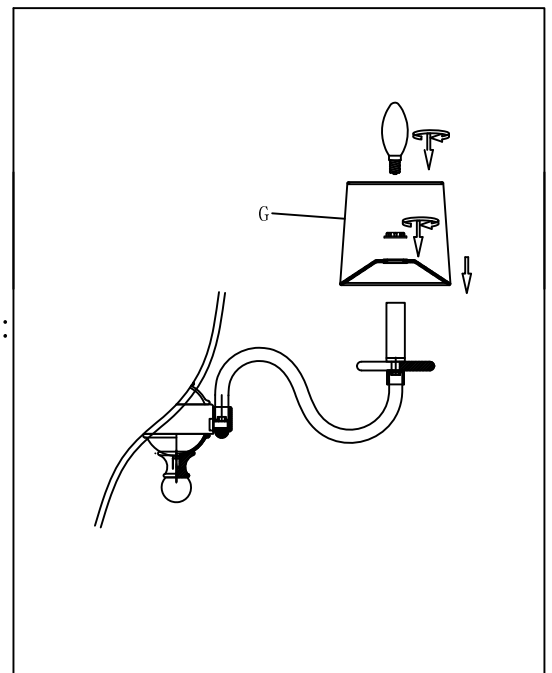

Place shade (G) on candle cover and secure using screw ring provided. Then install 40 W candelabra base bulb.

Cleaning & Care:

Clean with soft cloth and a mild detergent.
Do not use abrasive cleaner.