

PETITE CRYSTAL 1564- __ __ O

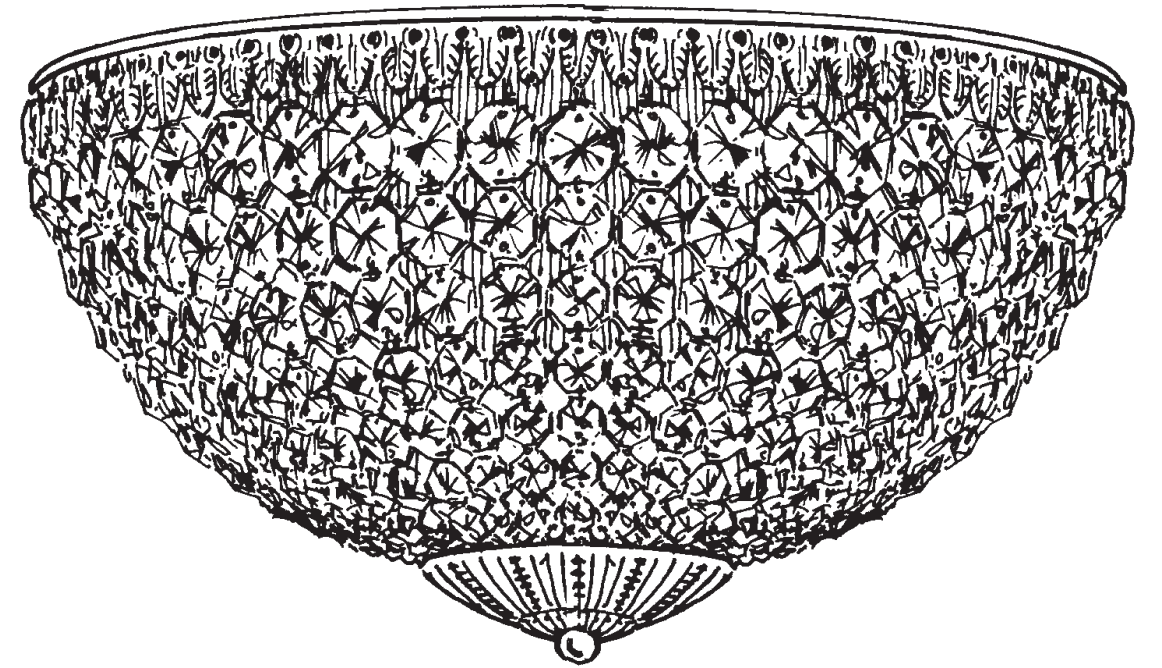











5 Lights
Diameter: 14"
Body Length: 7-1/2"
Hanging Weight: 5 lbs.

THIS DESIGN IS THE PROPRIETARY
TRADE DRESS/TRADEMARK OF
W SCHONBEK LLC.

 **SCHONBEK** | 1870

 **SCHONBEK** | 1870

								
MAX 40 W		110-120 V						

All electrical components must be installed by a licensed electrician in accordance with the National Electric Code and the appropriate local electrical codes.

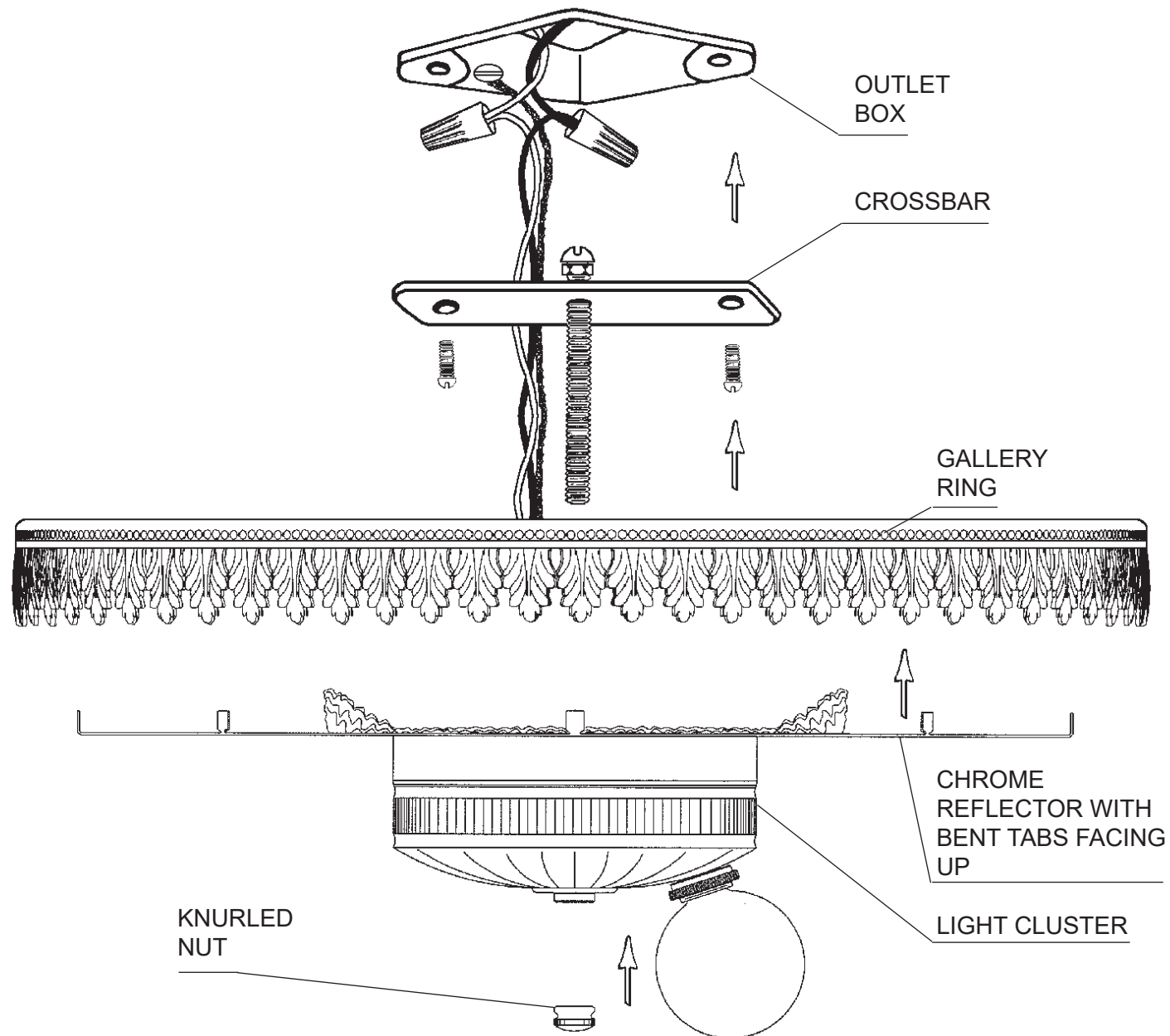

1 Remove crossbar from light cluster and reflector. Attach to outlet box in ceiling.

2 Place gallery ring over chrome reflector, with bent tabs facing up, and light cluster. Connect fixture ground wire to grounding screw in outlet box and complete connections of fixture conductors to main power leads. Fixture MUST be grounded.

3 Slide assembled parts - gallery ring together with chrome reflector (insulation pad above) and light cluster over thread attached to crossbar and secure with knurled nut. Make sure entire assembly is firmly against the ceiling. If the outlet box is not flush with ceiling, it may be necessary to adjust the thread attached to crossbar. Install bulbs and test power to insure proper wiring before hanging trim from fixture.

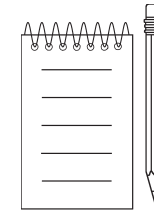
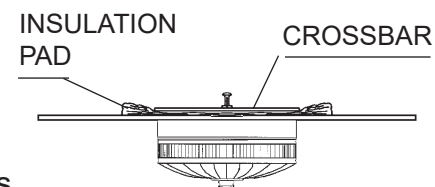



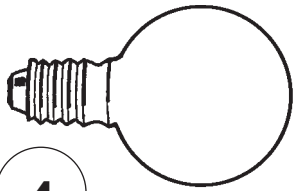

4

You will need 5 - G16-1/2
25 Watts Recommended
40 Watts Max
MIN 90°C SUPPLY
CONDUCTORS

Install bulbs and be sure
to test fixture **BEFORE**
trimming.

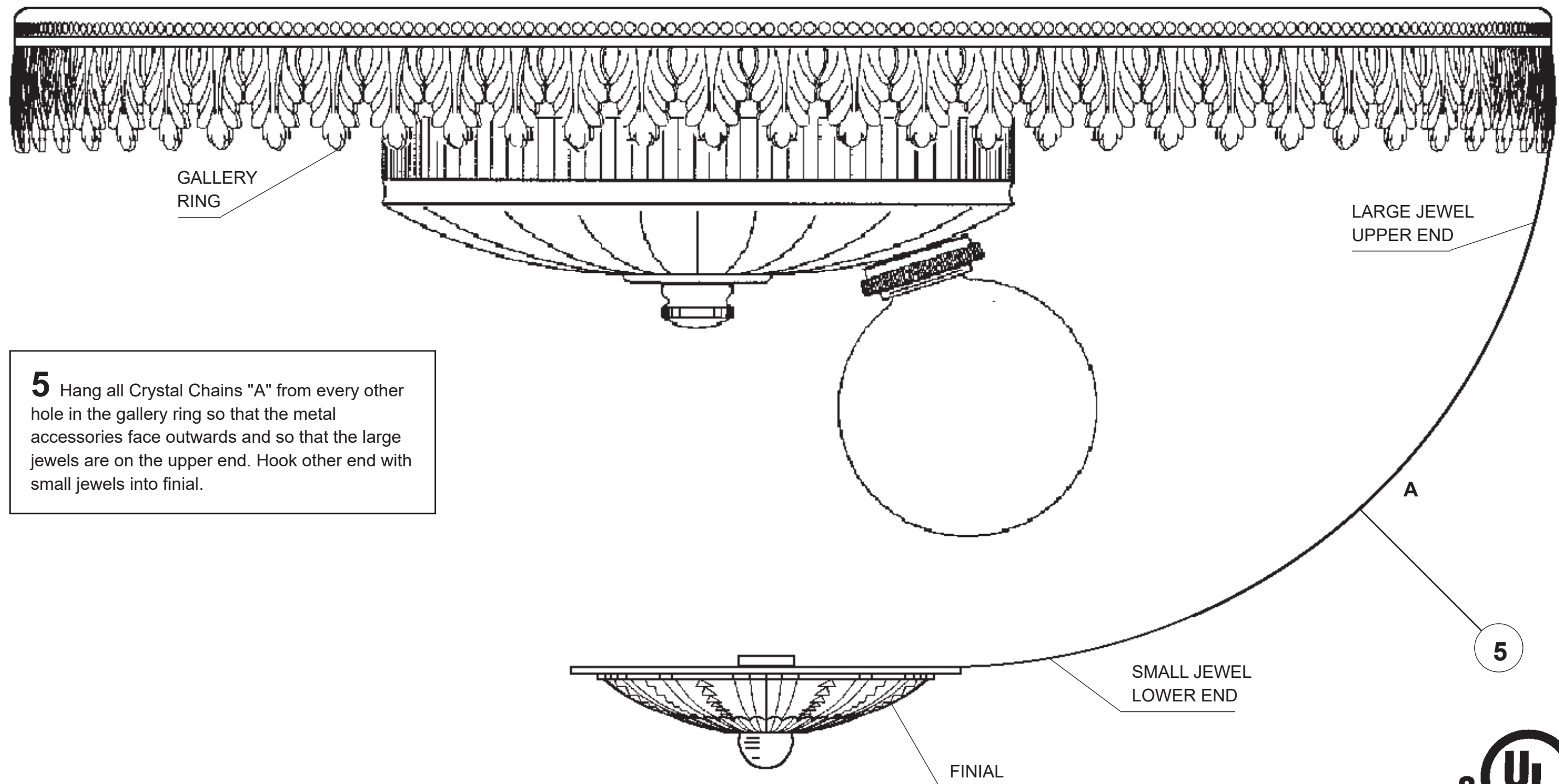

5 Hang all Crystal Chains "A" from every other hole in the gallery ring so that the metal accessories face outwards and so that the large jewels are on the upper end. Hook other end with small jewels into finial.



PETITE CRYSTAL 1564-__ __R

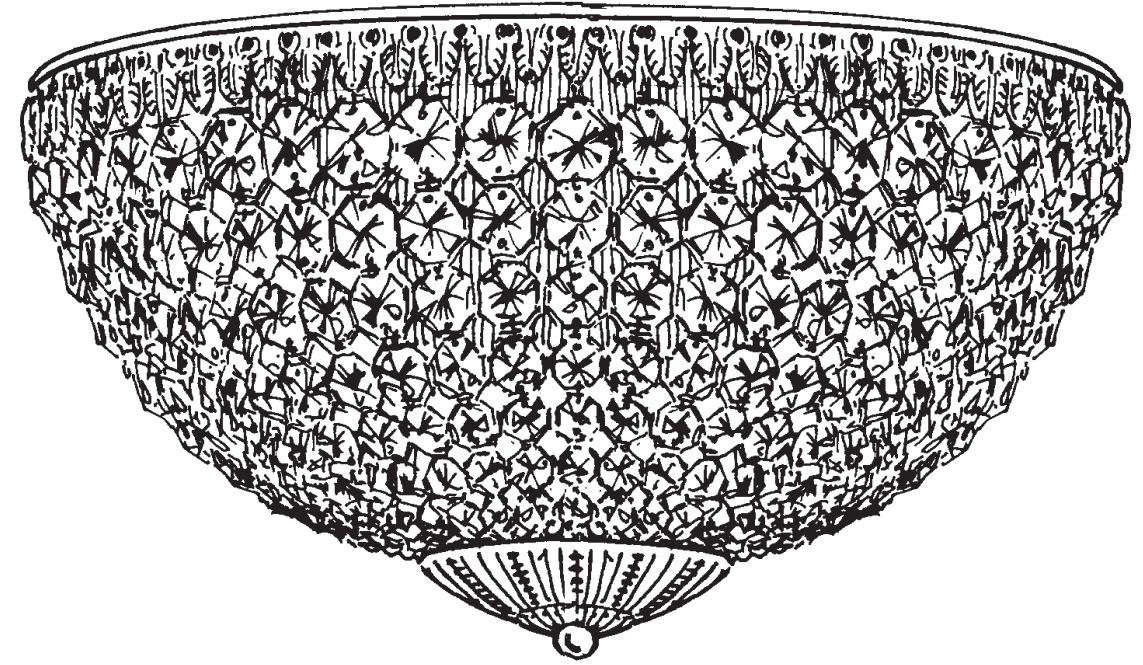











 **SCHONBEK** | 1870

THIS DESIGN IS THE PROPRIETARY
TRADE DRESS/TRADEMARK OF
W SCHONBEK LLC.

5 Lights
Diameter: 14"
Body Length: 7-1/2"
Hanging Weight: 5 lbs.

 **SCHONBEK** | 1870

								
MAX 40 W		110-120 V						

All electrical components must be installed by a licensed electrician in accordance with the National Electric Code and the appropriate local electrical codes.

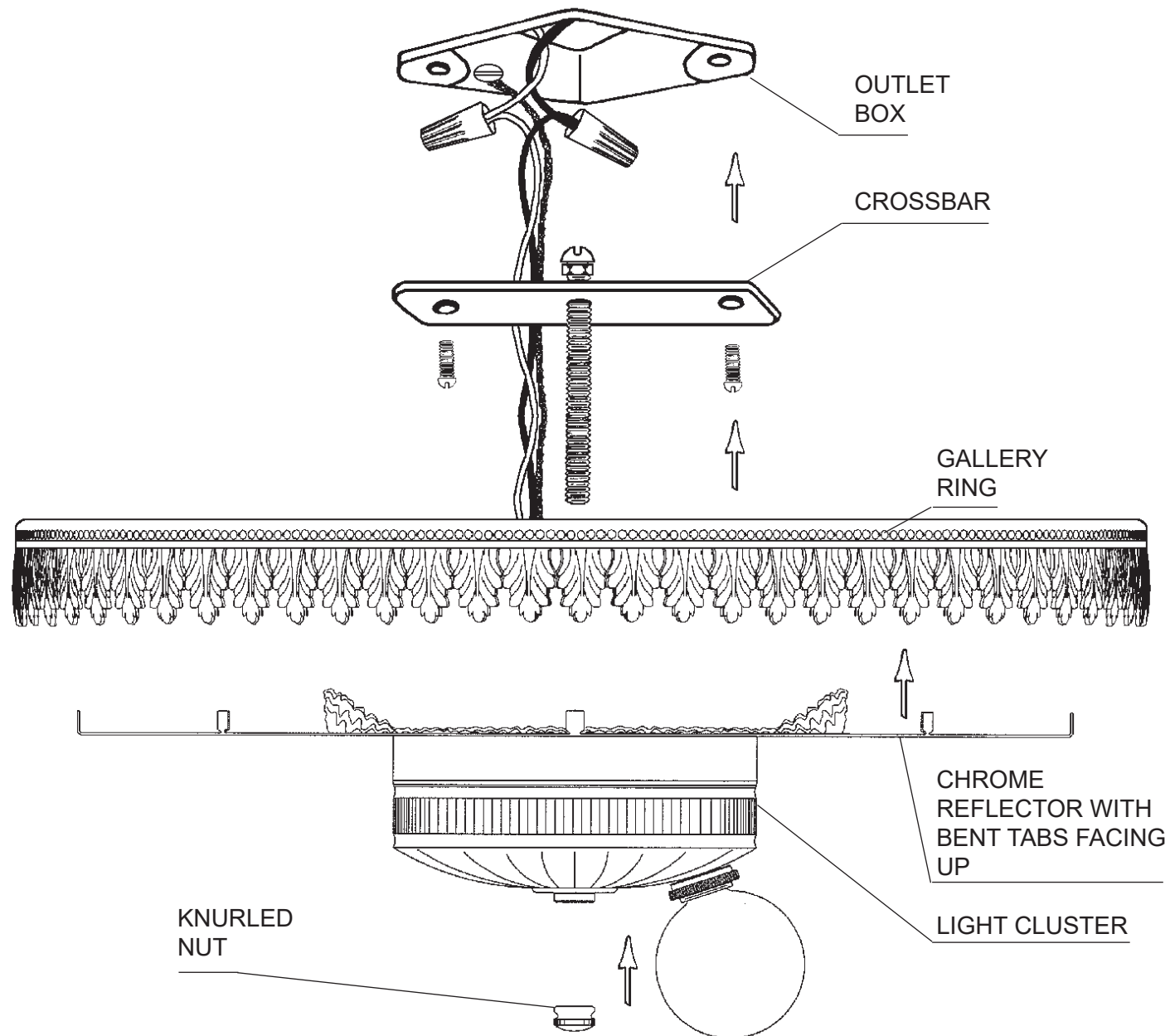

1 Remove crossbar from light cluster and reflector. Attach to outlet box in ceiling.

2 Place gallery ring over chrome reflector, with bent tabs facing up, and light cluster. Connect fixture ground wire to grounding screw in outlet box and complete connections of fixture conductors to main power leads. Fixture **MUST** be grounded.

3 Slide assembled parts - gallery ring together with chrome reflector (insulation pad above) and light cluster over thread attached to crossbar and secure with knurled nut. Make sure entire assembly is firmly against the ceiling. If the outlet box is not flush with ceiling, it may be necessary to adjust the thread attached to crossbar. Install bulbs and test power to insure proper wiring before hanging trim from fixture.

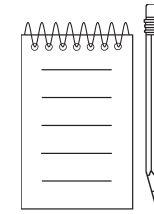
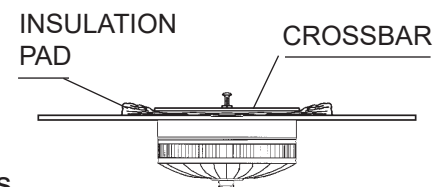

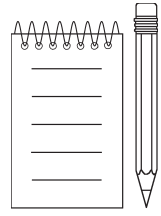

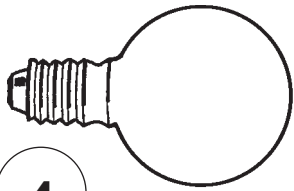

4

You will need 5 - G16-1/2
25 Watts Recommended
40 Watts Max
MIN 90°C SUPPLY
CONDUCTORS

Install bulbs and be sure
to test fixture BEFORE
trimming.

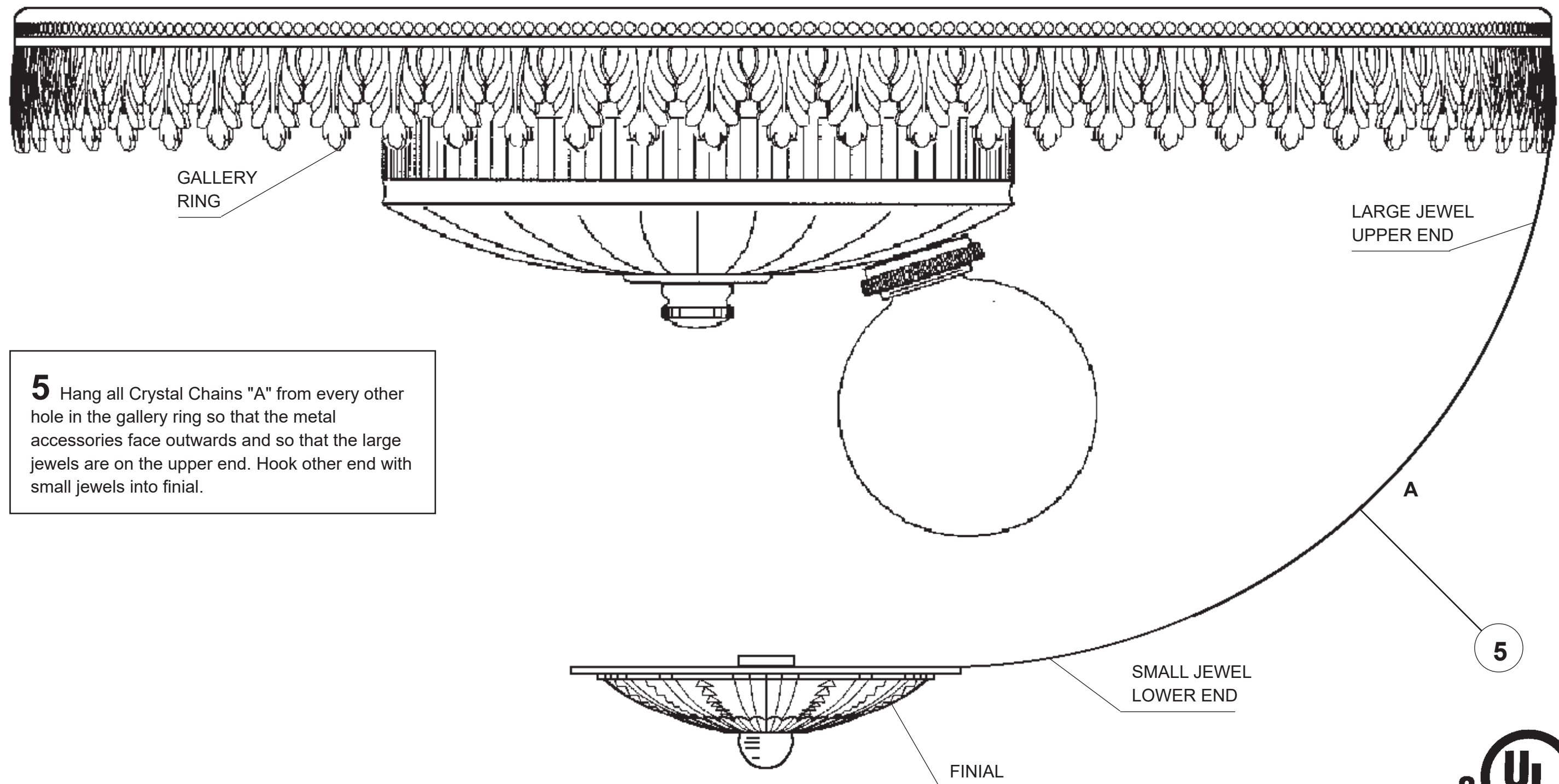

5 Hang all Crystal Chains "A" from every other hole in the gallery ring so that the metal accessories face outwards and so that the large jewels are on the upper end. Hook other end with small jewels into finial.



PETITE CRYSTAL 1564-__ __S

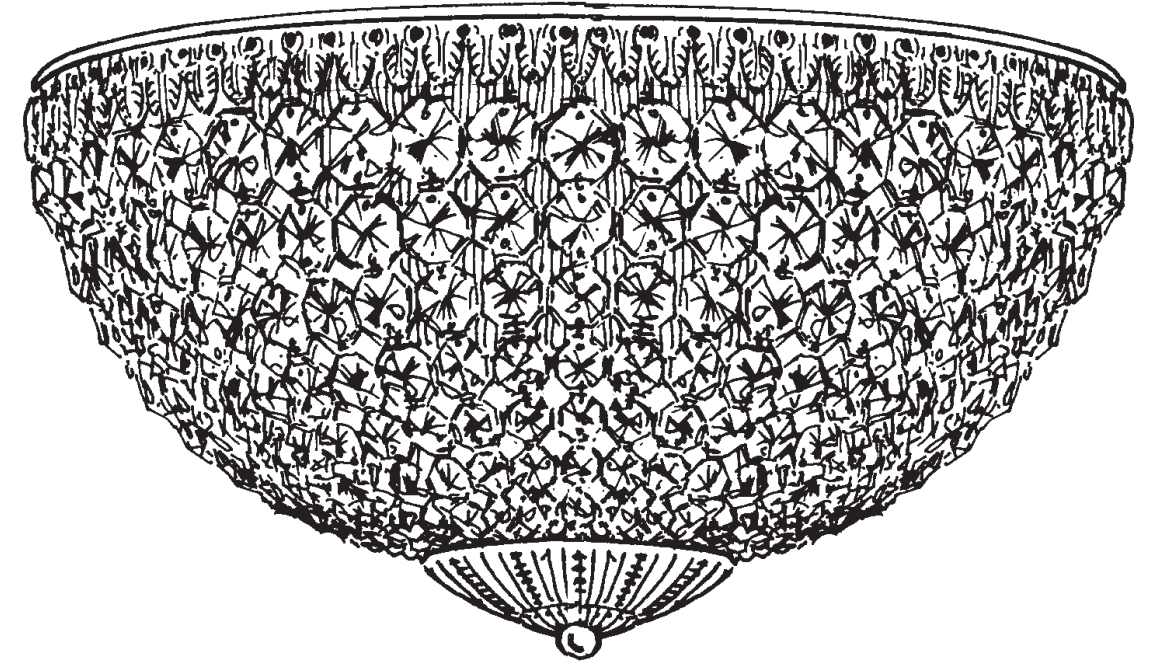











 **SCHONBEK** | 1870

THIS DESIGN IS THE PROPRIETARY
TRADE DRESS/TRADEMARK OF
W SCHONBEK LLC.

5 Lights
Diameter: 14"
Body Length: 7-1/2"
Hanging Weight: 5 lbs.

 **SCHONBEK** | 1870

								
MAX 40 W		110-120 V						

All electrical components must be installed by a licensed electrician in accordance with the National Electric Code and the appropriate local electrical codes.

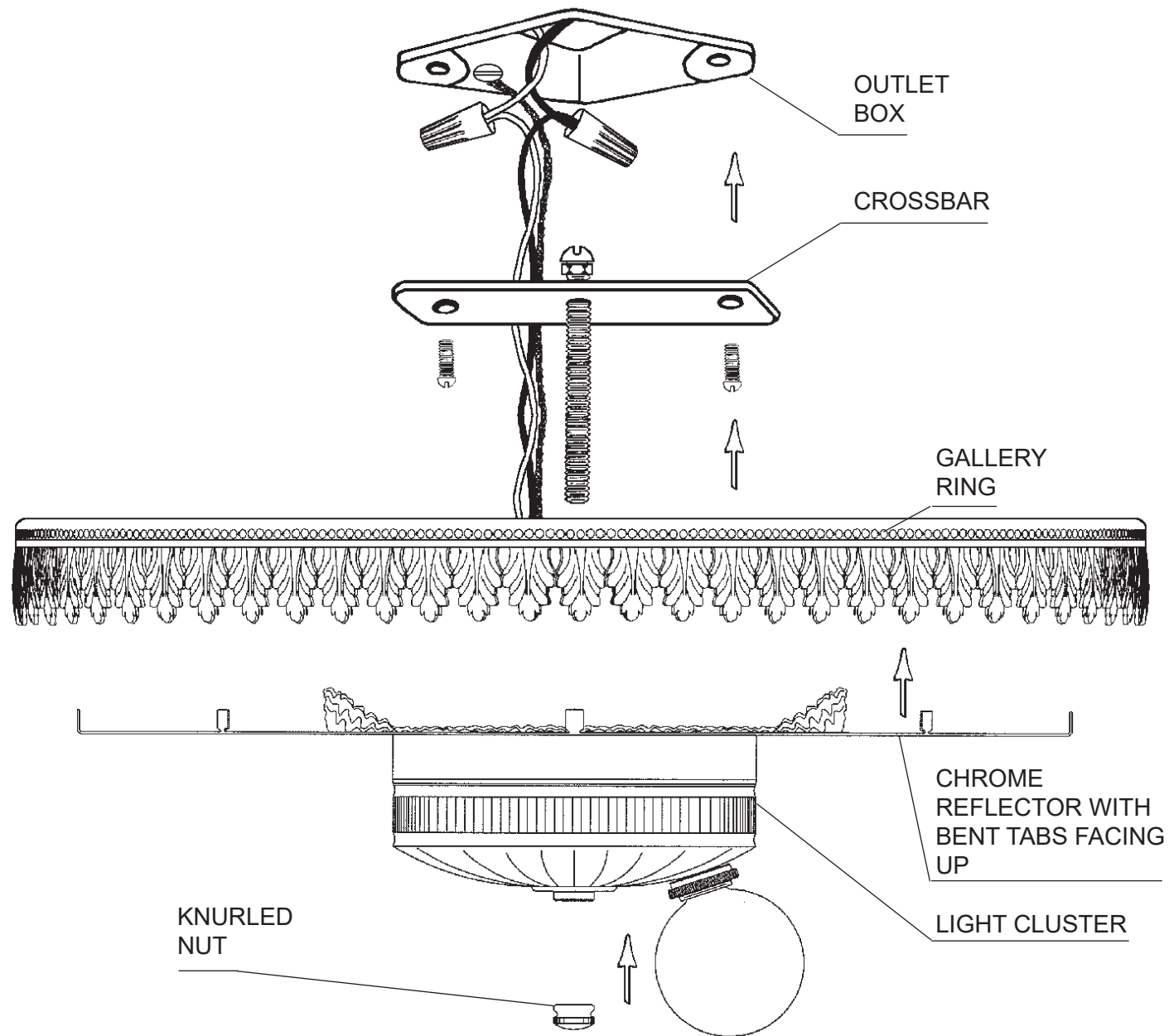

1 Remove crossbar from light cluster and reflector. Attach to outlet box in ceiling.

2 Place gallery ring over chrome reflector, with bent tabs facing up, and light cluster. Connect fixture ground wire to grounding screw in outlet box and complete connections of fixture conductors to main power leads. Fixture **MUST** be grounded.

3 Slide assembled parts - gallery ring together with chrome reflector (insulation pad above) and light cluster over thread attached to crossbar and secure with knurled nut. Make sure entire assembly is firmly against the ceiling. If the outlet box is not flush with ceiling, it may be necessary to adjust the thread attached to crossbar. Install bulbs and test power to insure proper wiring before hanging trim from fixture.

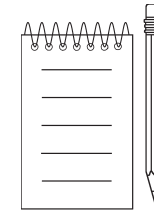
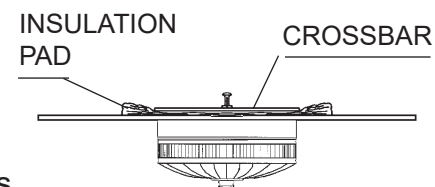



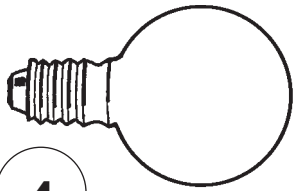

4

You will need 5 - G16-1/2
25 Watts Recommended
40 Watts Max
MIN 90°C SUPPLY
CONDUCTORS

Install bulbs and be sure
to test fixture BEFORE
trimming.

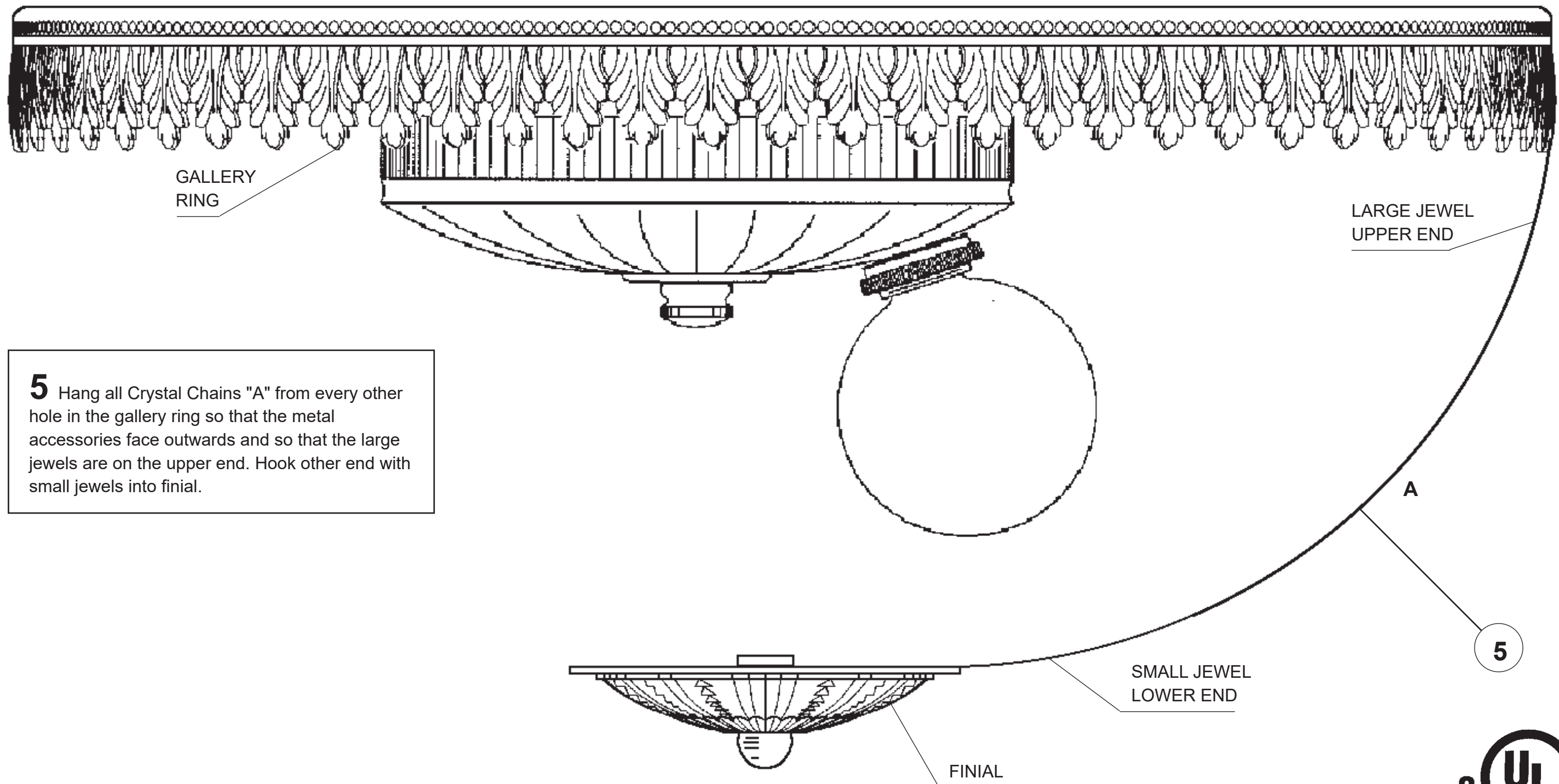

5 Hang all Crystal Chains "A" from every other hole in the gallery ring so that the metal accessories face outwards and so that the large jewels are on the upper end. Hook other end with small jewels into finial.

