



INSTALLATION INSTRUCTIONS

IMPORTANT SAFETY INSTRUCTIONS

MESURES DE SECURITE A RESPECTURE

Before assembling your ACCESS LIGHTING fixture, please make sure that you carefully read through this instruction sheet. Save this instruction sheet and refer to it when additions to or changes in the fixture configuration are made.

Lisez attentivement ce manuel d'instructions. Enregistrer cette feuille d'instructions et de s'y référer lorsque les ajouts ou changements dans la configuration de montage sont faites.

CONSULT A QUALIFIED ELECTRICIAN TO ENSURE CORRECT BRANCH CIRCUIT CONDUCTOR.

CONSULTER UN ELECTRICIEN QUALIFIE POUR VOUS ASSURER QUE LES CONDUCTEURS DE LA DERIVATION SONT ADEQUATS

THIS PRODUCT MUST BE INSTALLED IN ACCORDANCE WITH THE APPLICABLE INSTALLATION CODE BY A PERSON FAMILIAR WITH THE CONSTRUCTION AND OPERATION OF THE PRODUCT AND THE HAZARDS INVOLVED.

CE PRODUIT DOIT ETRE INSTALLE SELON LE CODE D'INSTALLATION PERTINENT, PAR UNE PERSONNE QUI CONNAIT BIEN LE PRODUIT ET SON FONCTIONNEMENT AINSI QUE LES RISQUES INHERENTS

NOTE: The important safeguards and instructions that appear in this manual are not meant to cover all possible conditions and situations that may occur. It must be understood that common sense, caution and care, are factors that can't be built into any product. These factors must be supplied by the person(s) caring for and operating the fixture.

Read all instructions

Do not install this fixture in hazardous locations.

N'installez pas cet appareil dans des emplacements dangereux.

Do not install any fixture assembly closer than 6 inches from any curtain or similar combustible material.

Laissez une distance d'au moins 6 pouces entre ce luminaire et la toute surface combustible.

"WARNING Risk of Fire and Electric Shock."

"CAUTION: Risque d' Incendie et de Choc Electriques."

GENERAL INFORMATION

All electrical connections must be in accordance with all ordinances, Local and the U.S. National Electrical Codes (NEC). These fixtures are intended for mounting to a standard 4" metal octagon outlet box. The box must be directly supported by the building structure and U.L. Recognized.

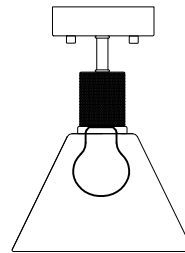

63146LEDDL

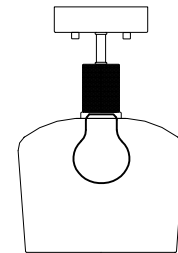

63147LEDDL

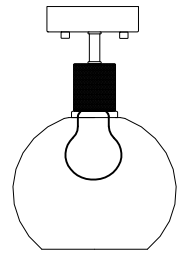

63148LEDDL

COLLECTION

PORT NINE

APPLICATION

Semi-Flush

MODEL NO.

63146LEDDL
63147LEDDL
63148LEDDL

WHAT WE PROVIDE

- Mounting Hardware
- Mounting bracket
- 1 x glass shade
- 1 x E26 ST19 LED bulb

WHAT YOU NEED

- Screwdriver
- Wire Cutters
- Wiring Supplies as Specified by Electrical Code

Recommended Dimmers for Supplied LED bulb

- (ELV) LUTRON Diva DVELV-303P
- (TRIAC) LEVITON Trimatron 6684
- (TRIAC) LEVITON illumatech IPI06
- (TRIAC) LUTRON Ariadni/Toggler TGCL-153P
- (TRIAC) LUTRON Diva DVCL-153P
- (TRIAC) LUTRON Skylark CL SCL-153 or SCL-153P
- (TRIAC) LUTRON Skylark S-600 or S-600P

STEP BY STEP INSTRUCTIONS

Before starting your installation disconnect the Power by turning off the Circuit Breaker or by removing the fuse at the fuse box. Just turning the light off at the light switch is not sufficient to prevent electrical shock.

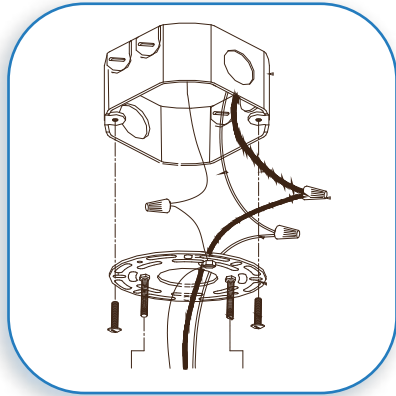

1

PREPARE THE FIXTURE AND MAKE WIRE CONNECTION

If there is an existing fixture remove it. Expose the supply wires from the J-box. Install the mounting bracket to the J-Box with the supplied screws. Gently pull the supply wires through the hole in the mounting bracket. Connect the black supply wire to the black fixture wire. Secure with the supplied wire nuts. Connect the white supply wire to the white fixture wire. Secure with the supplied wire nuts. Attach the green J-Box wire around green hexagonal head screw or connect it to the green supply grounding wire of the fixture. Secure all wires with electrical tape (not supplied). Tuck all wires carefully into the J-Box.

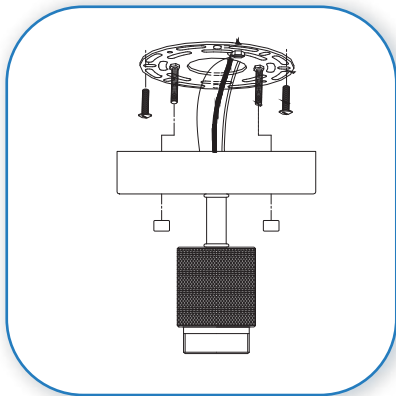

2

MOUNT THE CANOPY

Place the canopy up to the mounting bracket, align the holes and secure with the supplied screw knobs.

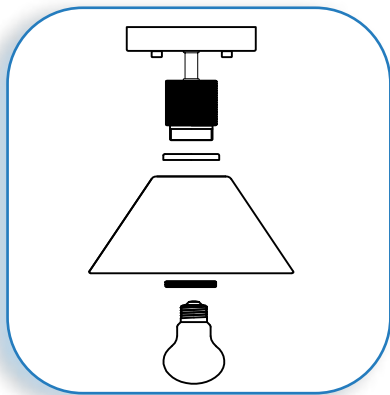

3

INSTALL THE GLASS SHADE AND THE BULB

Align the glass shade over the socket and secure with the supplied socket ring.

Insert the bulb.

DO NOT EXCEED THE MAXIMUM WATTAGE AS STATED ON THE WARNING LABEL

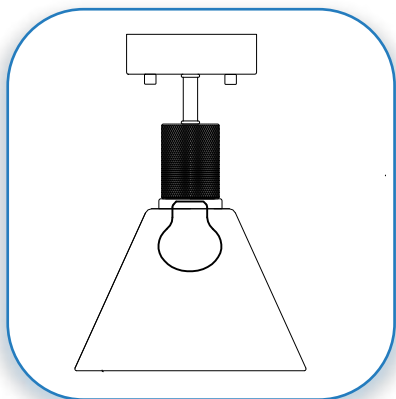

4

RESTORE THE ELECTRICITY AND CHECK THE OPERATION OF YOUR NEW ACCESS LIGHTING FIXTURE

CAUTION

Please ensure that the fitting is cool and switched off before replacing the bulb. DO NOT use bulbs that might exceed the maximum wattage, stated on caution label.