

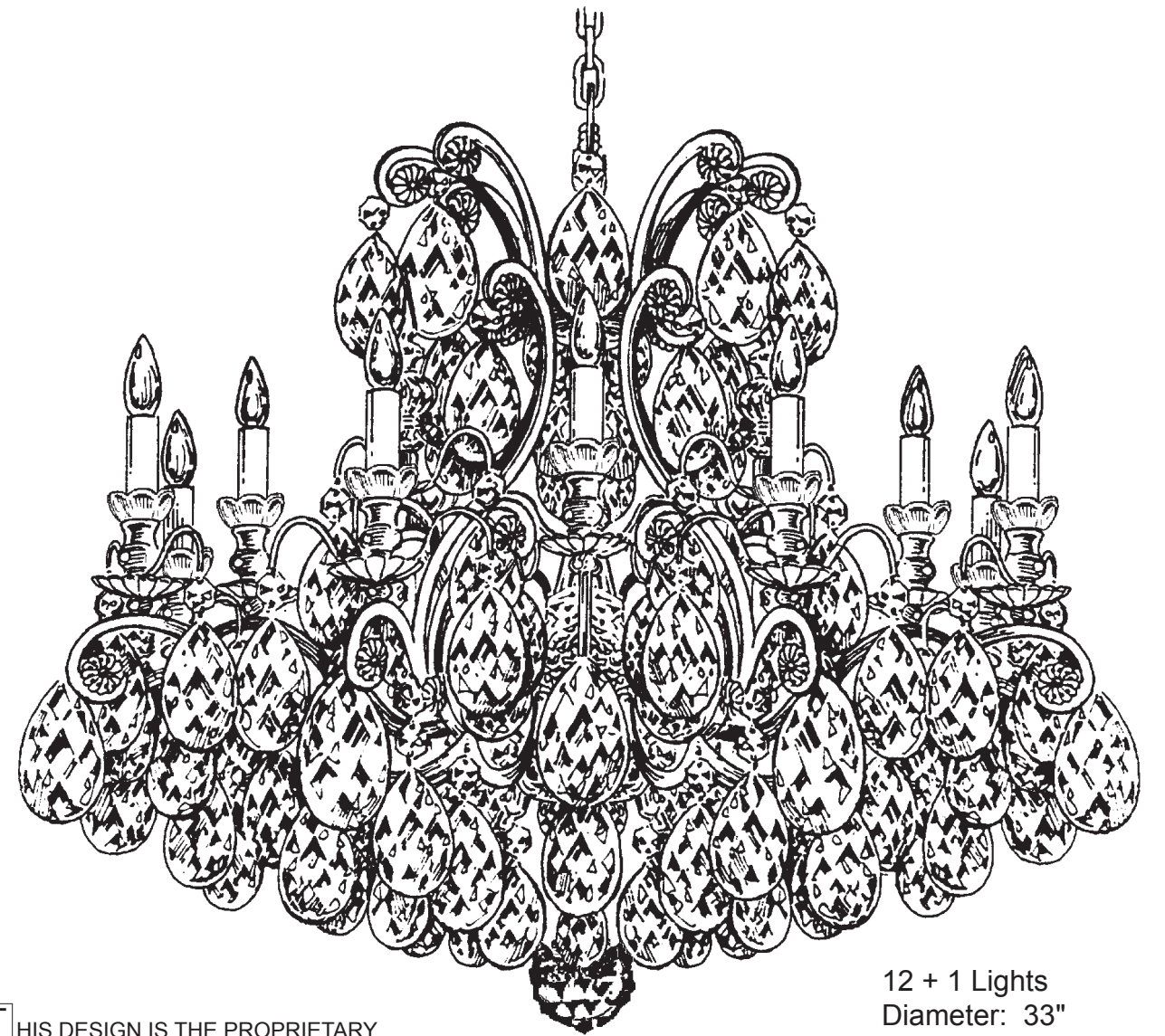

SCHONBEK®

RENAISSANCE 3790- _____



THIS DESIGN IS THE PROPRIETARY TRADE DRESS/TRADEMARK OF SWAROVSKI LIGHTING, LTD.

12 + 1 Lights
Diameter: 33"
Body Length: 26"
Hanging Weight: 50 lbs.



SCHONBEK®

MAX 60 W	MAX 15 W	110-120 V					

SCHONBEK® is a member of the Swarovski group.

All electrical components must be installed by a licensed electrician in accordance with the National Electric Code and the appropriate local electrical codes.

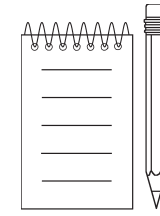
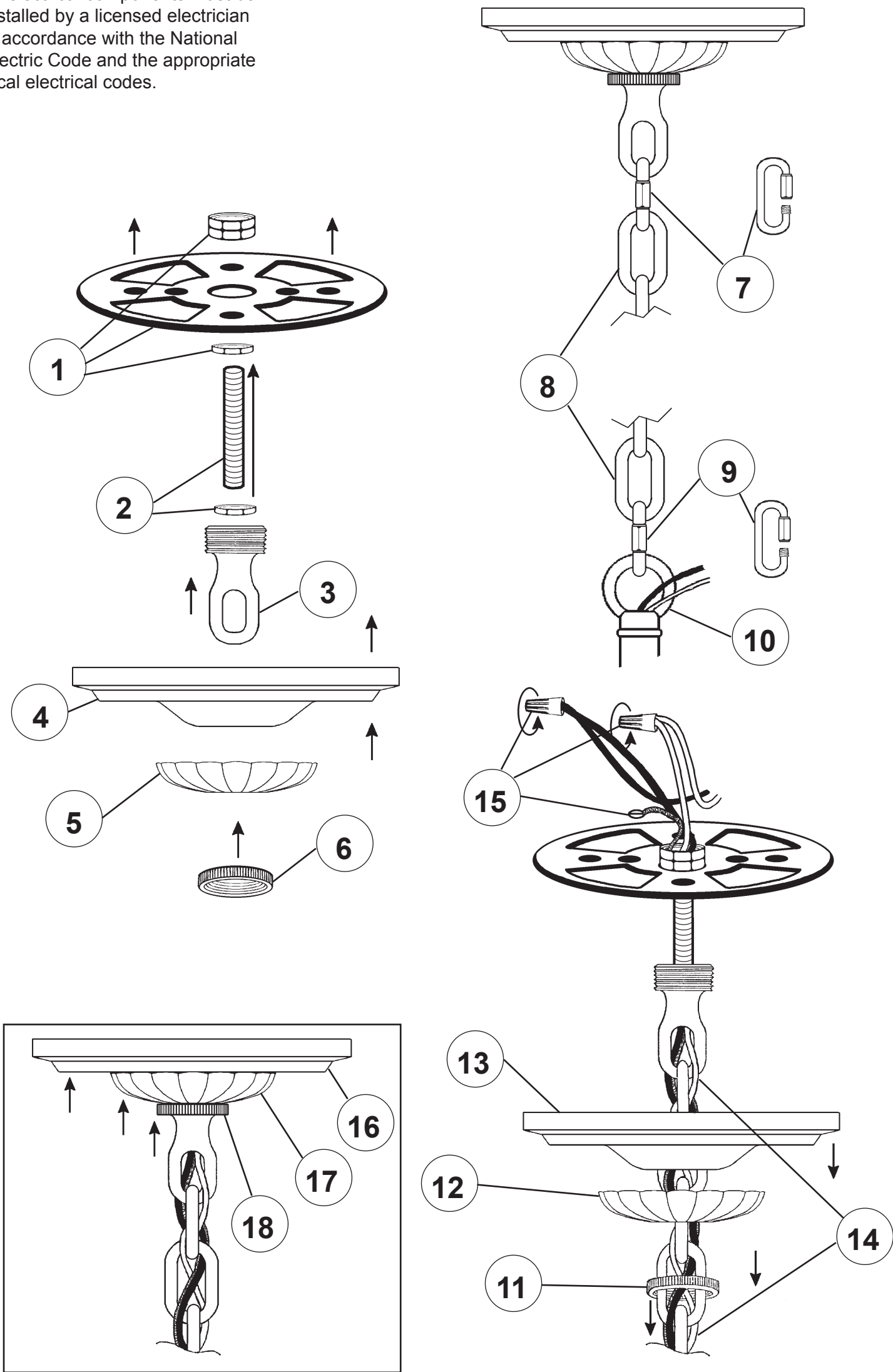

Crystal Set 3 in Black

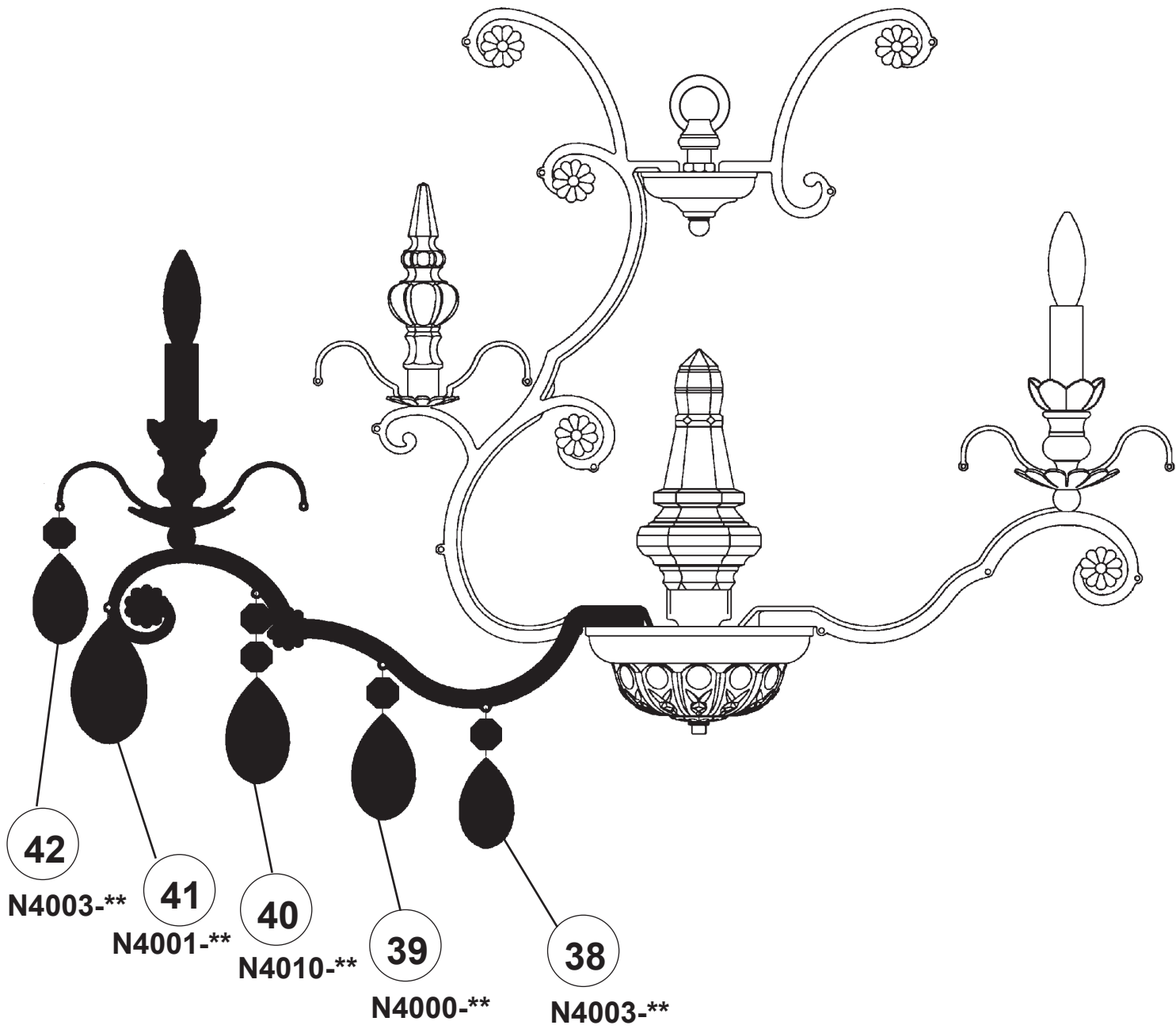

SET 1

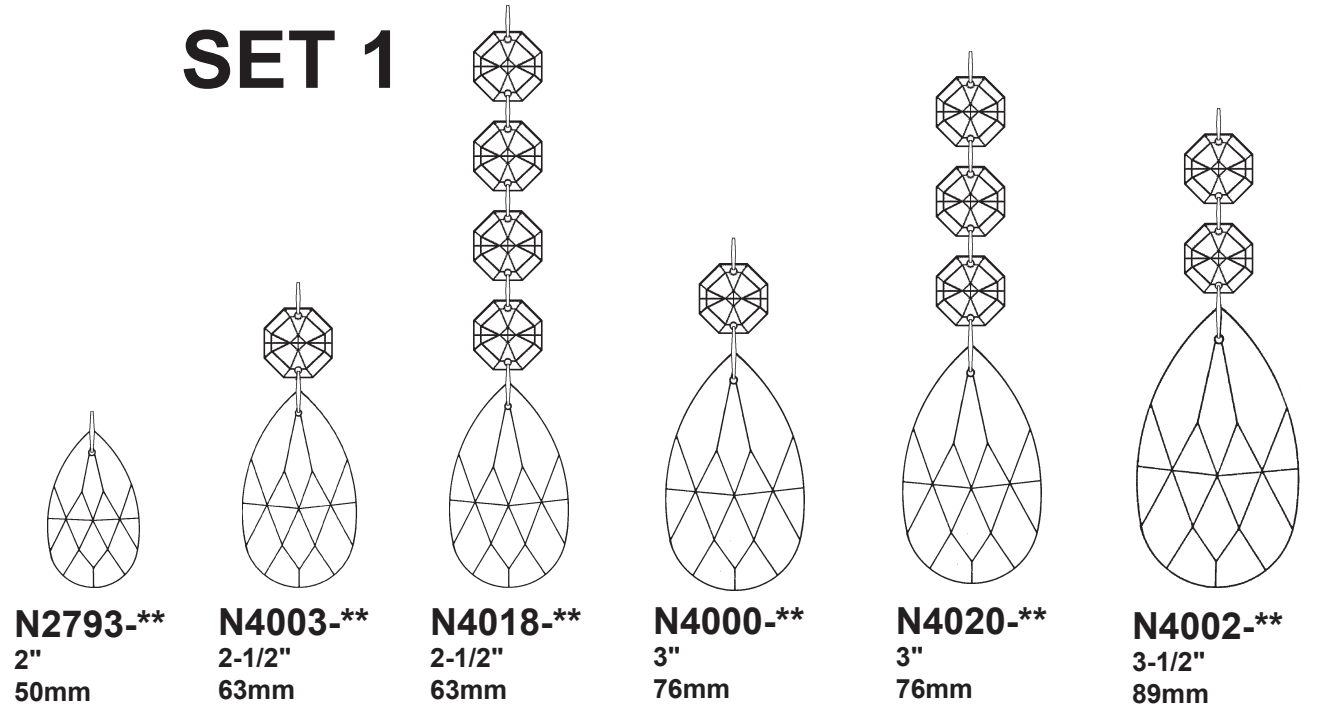

SET 2

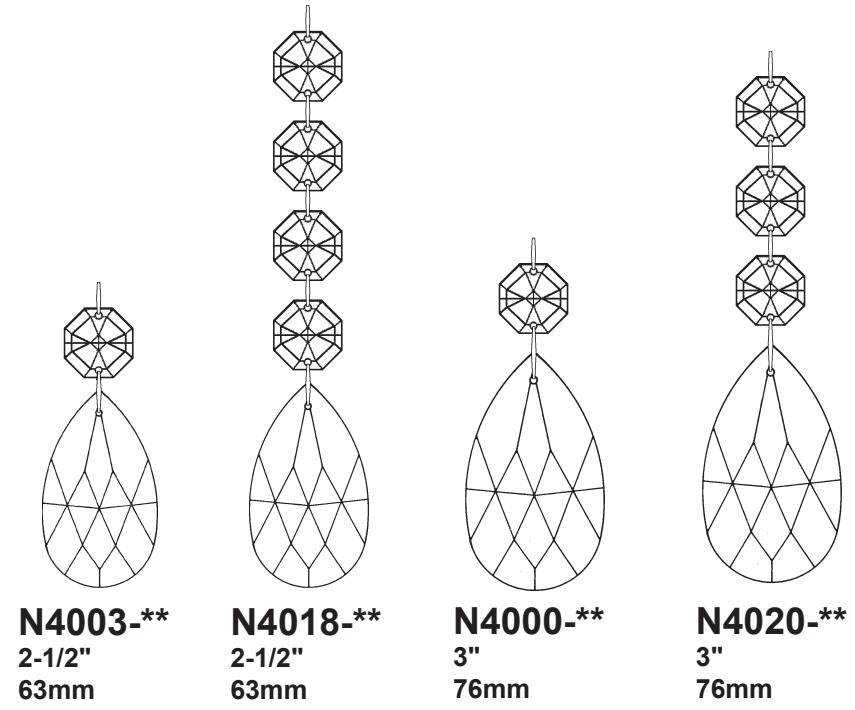

SET 3

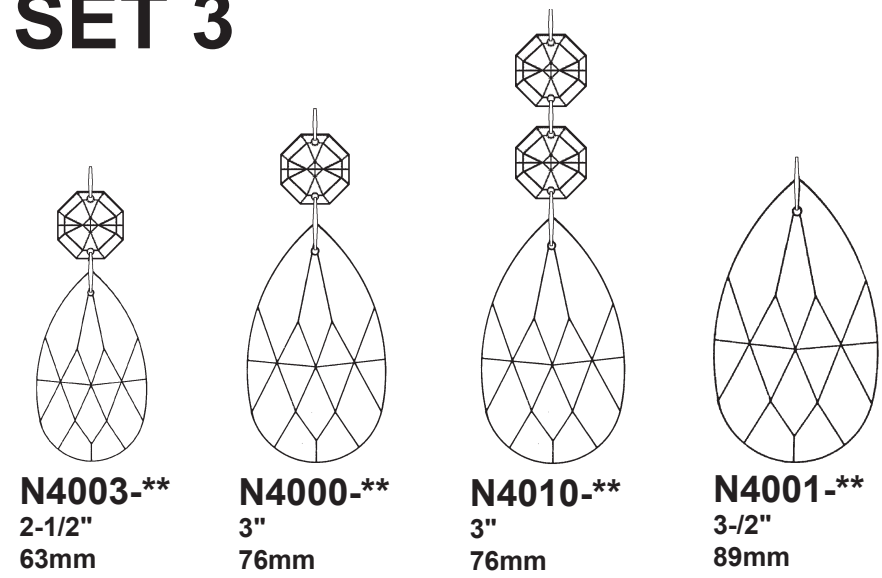

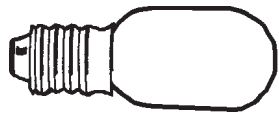

You will need 1 - T7
15 Watts Max
(Center Light)

20

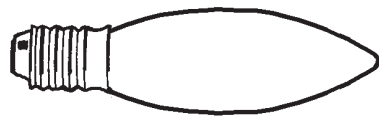

You will need 12 - B10
25 Watts Recommended
60 Watts Max

Install bulbs and be sure
to test fixture BEFORE
trimming.

Crystal Set 2 in Black

Crystal Set 1 in Black

