



SCHONBEK®

SONATINA ST1852N- __ __ H



14 Lights
Diameter: 35"
Height: 39"
Hanging Weight: 35lbs.

THIS DESIGN IS THE PROPRIETARY
TRADE DRESS/TRADEMARK OF
SWAROVSKI LIGHTING, LTD.



SCHONBEK®

MAX <u>60</u> W		110-120 V					

SCHONBEK® is a member of the Swarovski group.

WARNING:

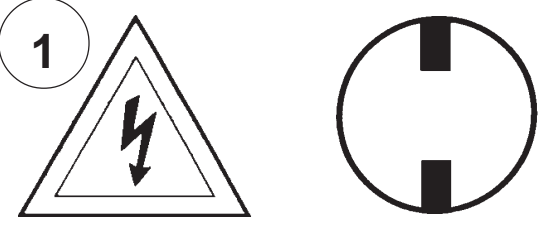
1 

Electrical Danger Turn Power Off

All electrical components must be installed by a licensed electrician in accordance with the National Electric Code and the appropriate local electrical codes.

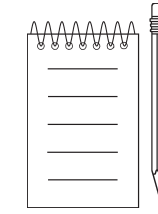
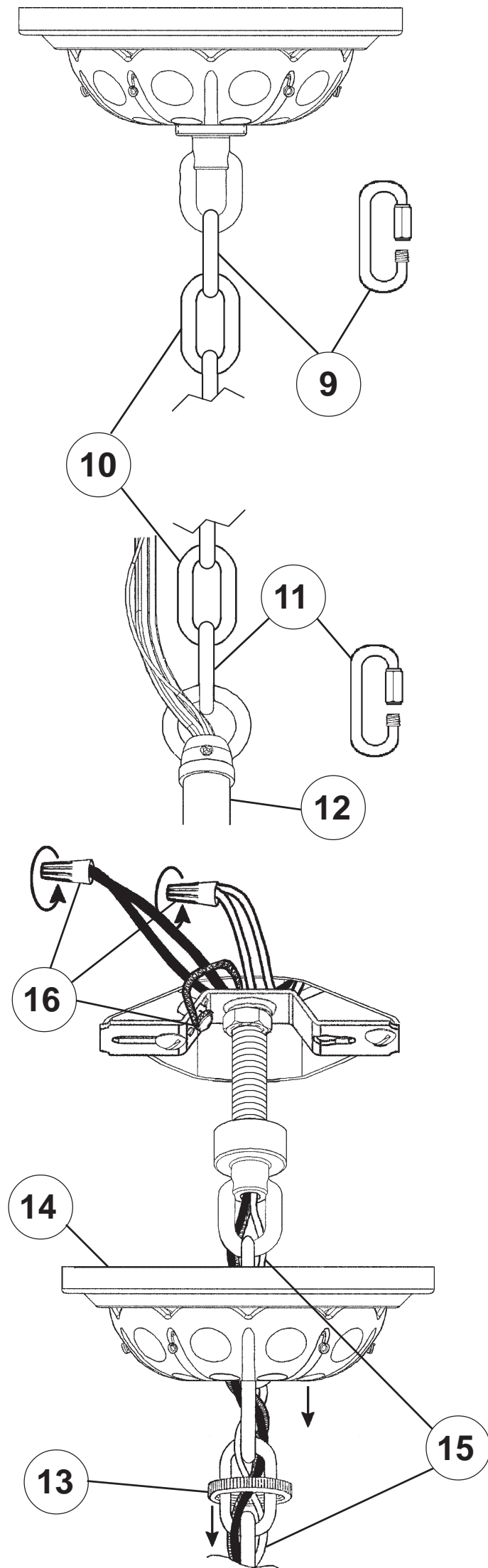
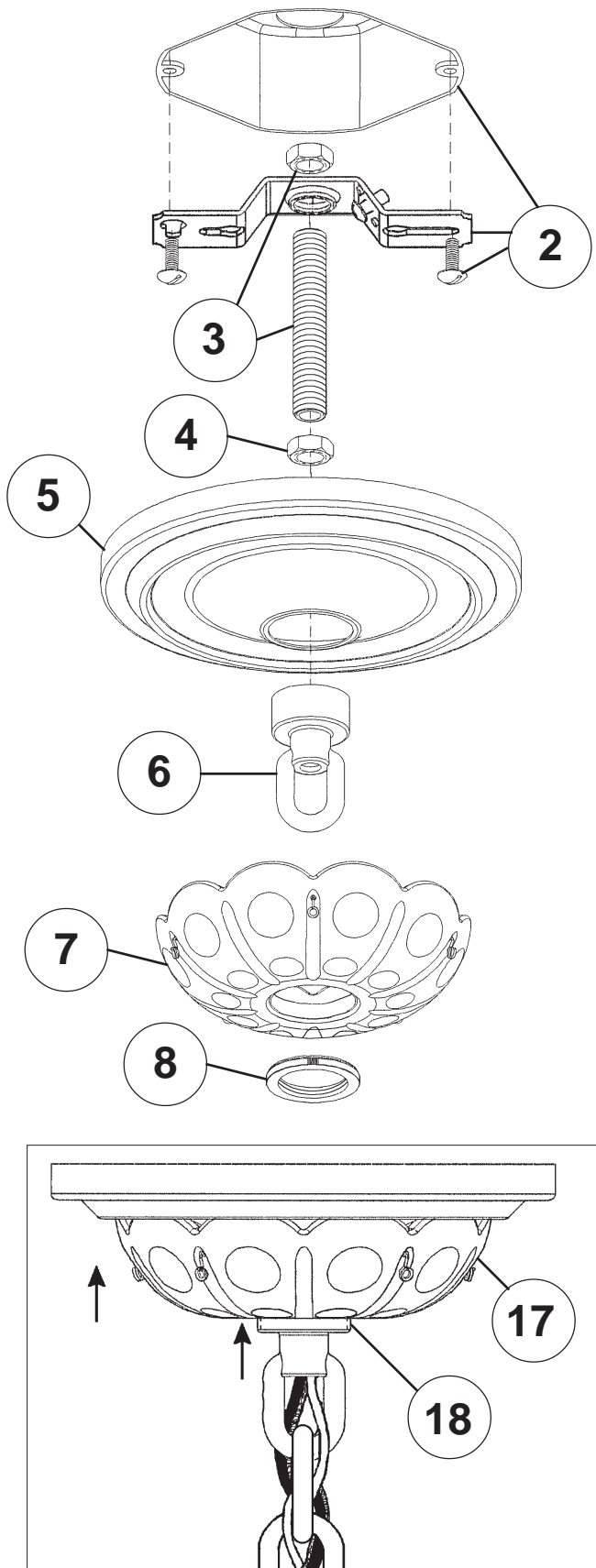

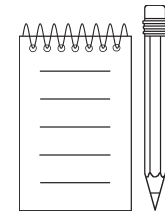
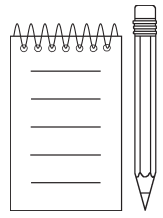

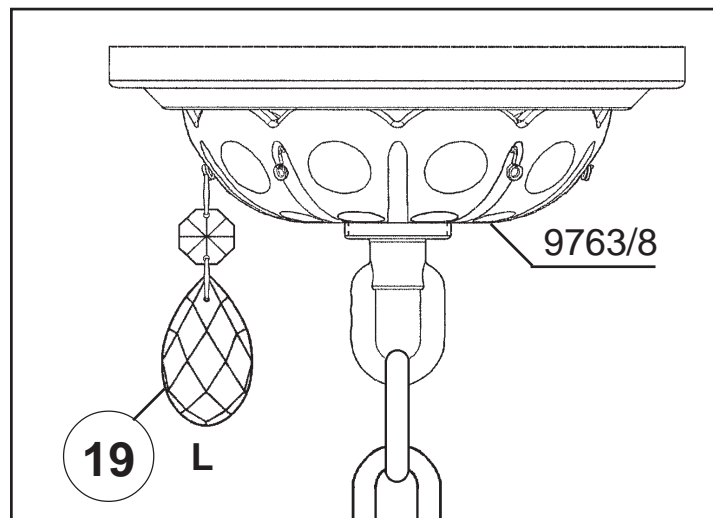

20

You will need 14 - B10
25 Watts Recommended
60 Watts Max

**Install bulbs and be
sure to test fixture
BEFORE trimming.**

