

Please go to [www.quoizel.com](http://www.quoizel.com) for product cleaning tips. Go to the **Care + Maintenance** selection.

**Tools Required:** Flathead screwdriver, Phillips screwdriver, pliers, wire cutters, wire strippers, electrical tape, safety glasses.

**Light Source:** (5) B10 Candelabra Base bulbs 60W Maximum, bulb not included.

**Fixture Hanging Height:** Minimum Hanging Height is 28.25", Maximum Hanging Height is 78".

**Estimated Assembly Time:** 30-45 minutes

**Preparation:** Identify and inspect all parts before beginning installation. Check package content list and diagrams below to ensure all parts are present. If any parts are missing or damaged, do not attempt to assemble, install, or operate the fixture. Missing Parts? Contact your original place of purchase.

## ⚠ Warnings and Cautions

Turn off electricity at circuit breaker or main fuse box before installation. Consult a licensed electrician if in doubt.

These instructions are provided for your safety. It is very important you read them completely before installing the fixture. We strongly recommend that a licensed, professional electrician perform the installation.

Disconnect fixture from power source before replacing bulbs. Make sure bulbs are given sufficient time to cool before removal.

## Package Contents

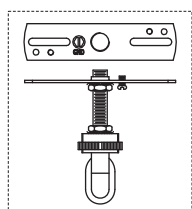

**A** Crossbar Assembly x 1



**B** Fixture Chain x 1



**D** Ceiling Canopy x 1

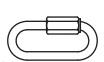

**C** Quick Link x 2

**Note:** 1pc replacement part is provided for each glass accents.

 Glass Accent A x 11

 Glass Accent B x 16

 Glass Accent C x 6

 Glass Accent D x 11

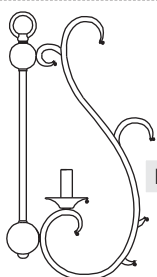

**E** Fixture Body x 1

## STEP 1 - Install the Crossbar Assembly to Outlet Box and Adjust the length of the Nipple

- Attach the Crossbar Assembly (A) to the Outlet Box with the head of the Green Ground Screw facing you. Secure it with Outlet Box Screws (not included), tighten until snug.
- Adjust the hex nut and lock washer underside of the crossbar to the middle of the nipple.
- Remove the canopy lock ring from the canopy chain loop. Place the Ceiling Canopy (D) over the canopy chain loop against the ceiling to determine the correct position of the nipple. Thread the canopy lock ring onto the canopy chain loop. Adjust the nipple to allow the Ceiling Canopy (D) to rest against the ceiling when held in place by the canopy lock ring.
- Remove the canopy lock ring and the Ceiling Canopy (D). Tighten the lock washer and the hex nut against the crossbar to secure in place.

Figure 1

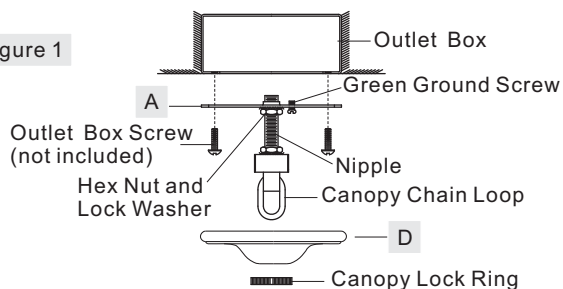

## STEP 2 - Install the Fixture Chain and Ceiling Canopy

- Adjust the Fixture Chain (B) to your desired length by removing links if needed. Put a cloth over the Fixture Chain (B) to protect the finish.
- Pull the supply wires through the Fixture Chain (B) alternating links. After the wires are through the Fixture Chain (B), pull the Supply Wires and the Ground Wire through the canopy lock ring and the Ceiling Canopy (D) in order.
- Attach one end of the Fixture Chain (B) to the fixture loop with one Quick Link (C). Lift the fixture and Fixture Chain (B) up and attach the other end of the Fixture Chain (B) onto the canopy chain loop with another Quick Link (C). The fixture will now hang safely.
- Feed the Supply Wires and Ground Wire through the canopy chain loop and nipple into the outlet box. Cut the wires leaving approximately 8" of wire extending from the Outlet Box.
- Go to Step 4 for wire connections and follow the directions. Return to Step F in this step when complete with Step 3.
- Raise the Ceiling Canopy (D) and canopy lock ring up the Fixture Chain (B) and over the canopy chain loop. Tighten the canopy lock ring onto the canopy chain loop until tight.

Suggested chain length for Ceiling height :

- 8' ceiling : use 5links of chain and 2 quick links
- 9' ceiling : use 15links of chain and 2 quick links
- 10' ceiling : use 25 links of chain and 2 quick links

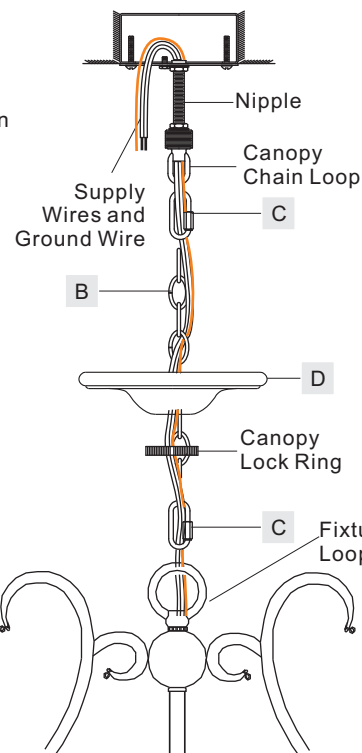

Figure 2

### STEP 3 - Making the Wire Connections

- Wrap bare or green ground wire around green ground screw on the crossbar, no less than 2 inches from the end of the wire. Tighten the green ground screw.
- Use standard wire connectors (not included) to make all wire connections. Twist connectors until wires are tightly joined together. Wrap each connection with approved electrical tape and carefully stuff all the connected wires into outlet box.

Note: If the electrical wire is going to be cut shorter than provided you will need to identify the "L" line wire and the "N" neutral wire before you cut the excess wire off. One is labeled N and the other labeled L. To do this separate the "L" line wire and the "N" neutral wire as far as you need to. Re-label the wire near where you want to make the cut. Be sure to mark the wire on the side of the fixture and not on the excess wire being cut and removed.

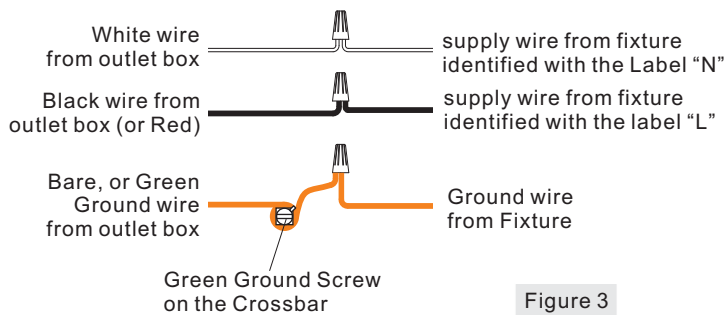

Figure 3

### STEP 4 - Install the Glass Accents and the Bulbs

- Attach hooks on glass accents to the loops on support arms of the fixture as shown in the illustration.
- Insert the bulb onto the socket and screw snugly into place.

Your fixture is now assembled and ready to use. Enjoy!

Figure 4

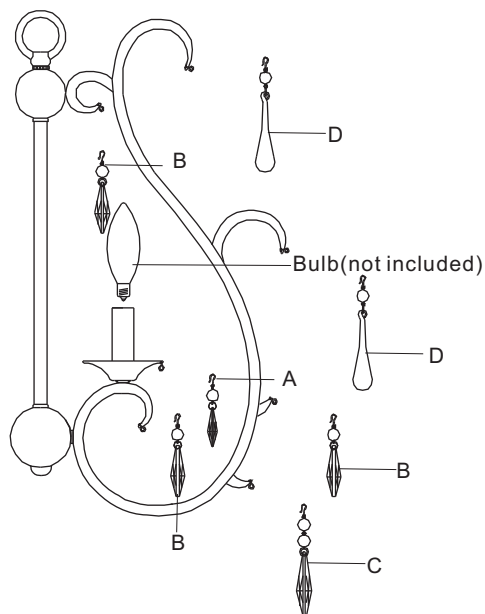

BLC5005AWH

FINISH: ANTIQUE WHITE

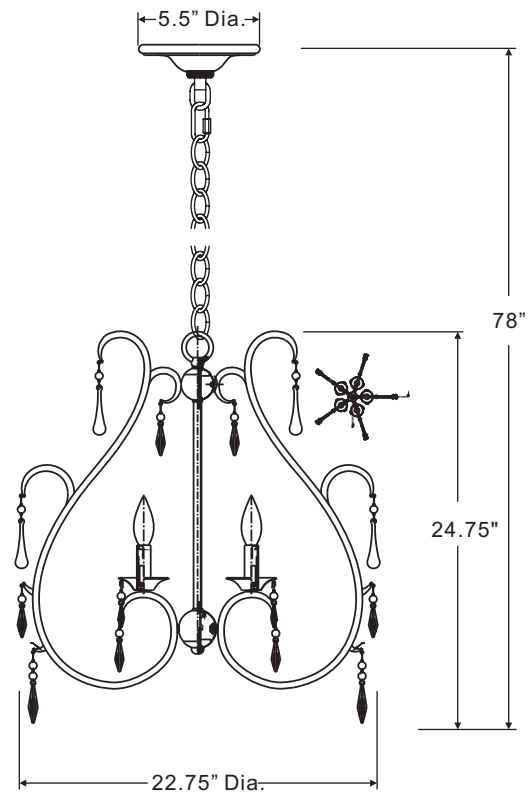
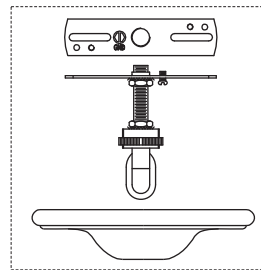

NOTE: ALL DIMENSIONS ARE ROUNDED UP TO THE NEAREST 1/4"