

Assembly Instructions for 1271

We recommend installation of this fixture be done by a licensed electrician. Turn off power at the main fuse or circuit breaker box. **DO NOT EXCEED RECOMMENDED WATTAGE!**

**** Actual parts may vary slightly depending upon the model**

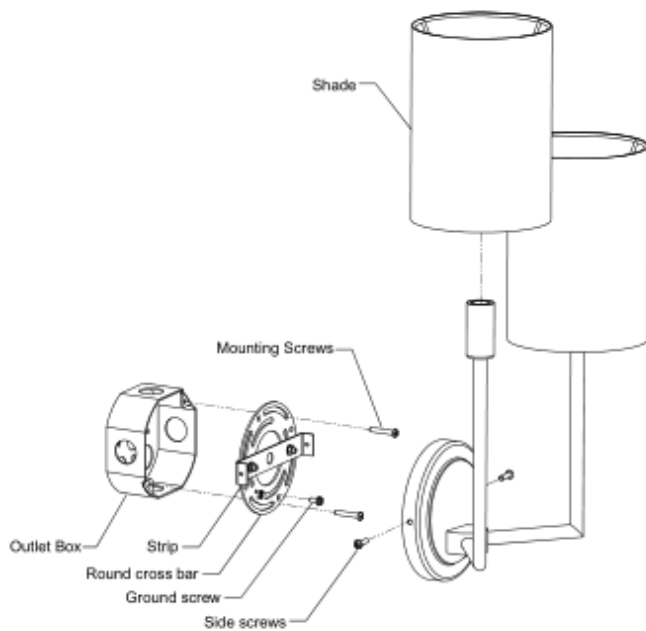

1. Remove the parts carefully from the box before discarding the carton
2. Attach round cross bar with strip to the outlet box with ground screw facing out.
3. Fasten ground wire to green screw, Fasten lead wire (or white wire) with ridges to the white wire. Use wire nut to fasten it.
4. Fasten smooth (or black wire) lead wire to the black wire in the box & use nut to fasten it.
5. Place the fixture over the outlet box with holes on the backplate/canopy aligning with the strip.
6. Secure the fixture using fixture screws.
7. Install the shade over the socket.
8. Install bulbs (not included).
9. Restore circuit breaker.