

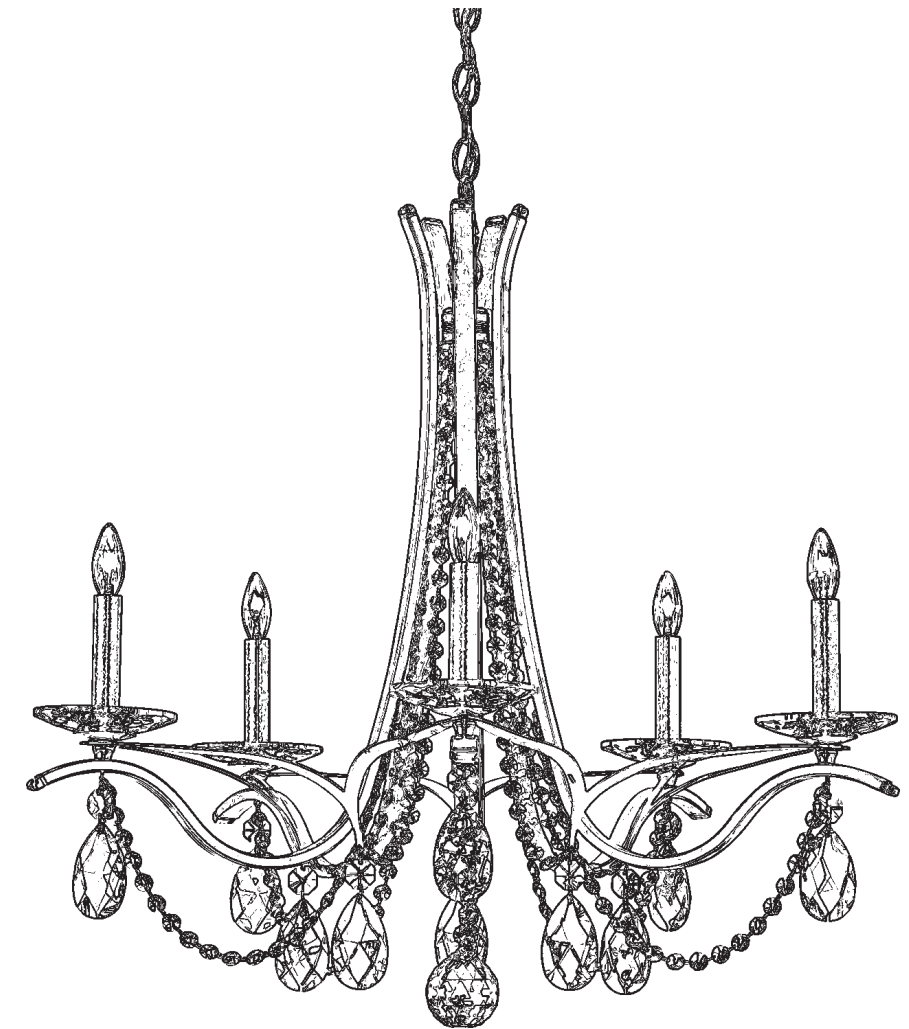

**SCHONBEK®**

**VESCA VA8335N- \_\_ \_\_ A**



5 Lights  
Diameter: 29"  
Height: 29"  
Hanging Weight: 17lbs.

**T**HIS DESIGN IS THE PROPRIETARY  
TRADE DRESS/TRADEMARK OF  
SWAROVSKI LIGHTING, LTD.



**SCHONBEK®**



MAX 60 W

110-120 V

SCHONBEK® is a member of the Swarovski group.

**WARNING:**

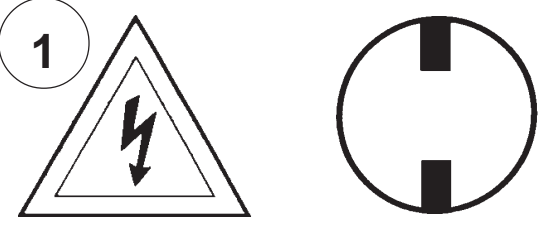
1 

**Electrical Danger Turn Power Off**

All electrical components must be installed by a licensed electrician in accordance with the National Electric Code and the appropriate local electrical codes.

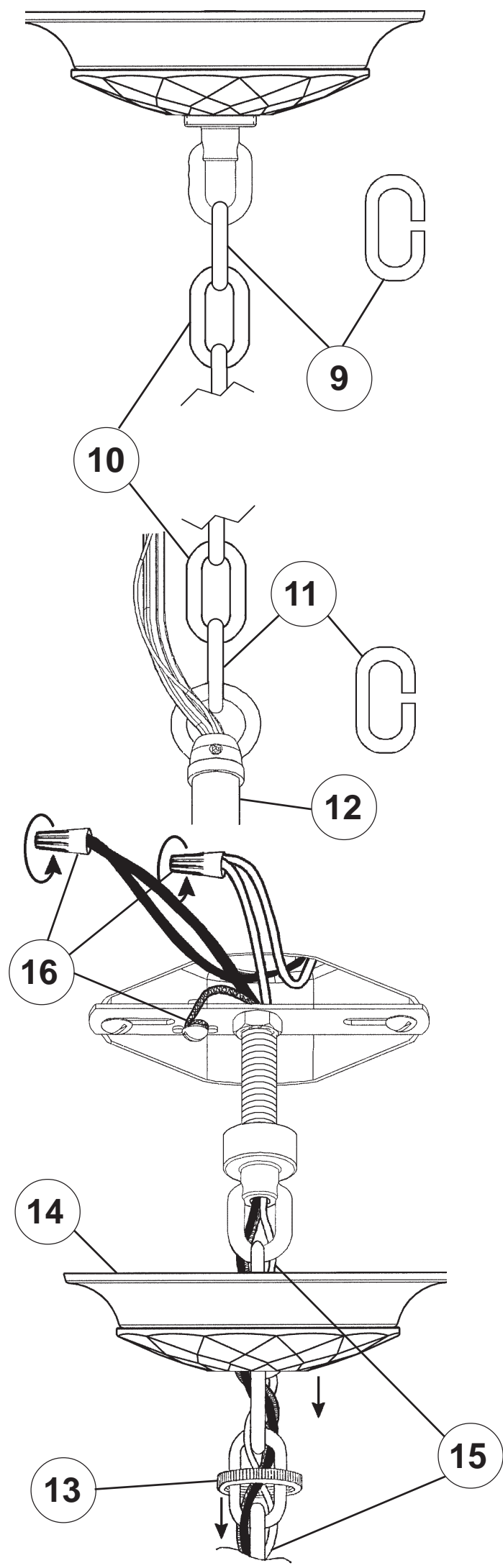
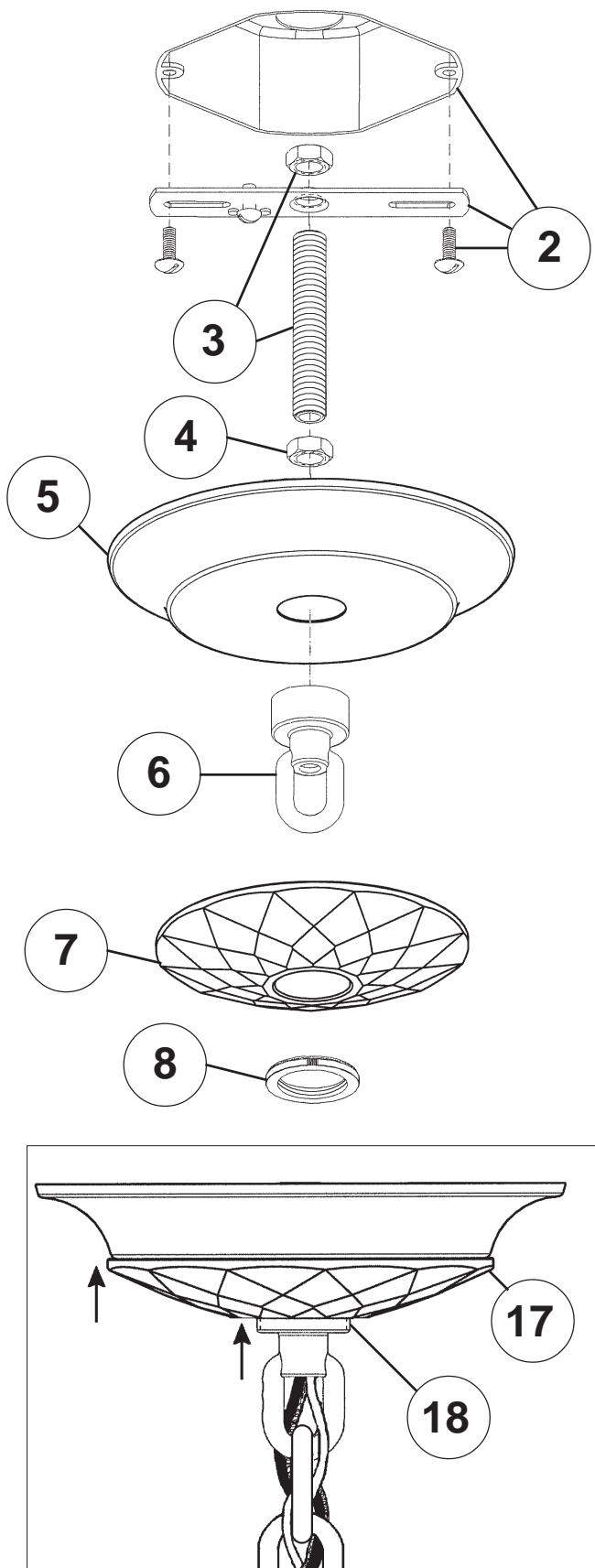

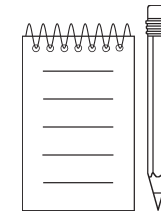
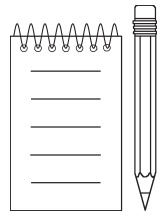



19

You will need 5 - B10  
25 Watts Recommended  
60 Watts Max

Install bulbs and be  
sure to test fixture  
BEFORE trimming.

