

QUOIZEL

6 CORPORATE PARKWAY
GOOSE CREEK, SC. 29445
www. quozel. com

Quoizel, Inc.
6 Corporate Parkway
Goose Creek, SC 29445

Customer Service
Phone 631.273.2700
Fax 631.231.7102
www. quozel. com

Assembly Instruction Sheet #IS-QJ6781TR For Style QJ6781TR

Tools Required: Flathead screwdriver, Phillips screwdriver, pliers, wire cutters, wire strippers, electrical tape, safety glasses.

Bulb Recommended: (2) Medium Base 60W Maximum, Alternate bulb (2) 13W CFL

Estimated Assembly Time: 10-15 minutes

Preparation: Identify and inspect all parts before beginning installation. Check package content list and diagrams below to be sure all parts are present. If any parts are missing or damaged, do not attempt to assemble, install, or operate the fixture. Contact customer service for replacement parts.

⚠ Warnings and Cautions

Turn off electricity at circuit breaker or main fuse box before installation. Consult a licensed electrician if in doubt.

These instructions are provided for your safety. It is very important you read them completely before installing the fixture. We strongly recommend that a licensed, professional electrician perform the installation.

Disconnect fixture from power source before replacing bulbs. Make sure bulbs are given sufficient time to cool before removal. Do not subject glass parts to any shock while in operation or shattering may result.

Package Contents

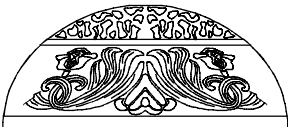

A Shade x 1

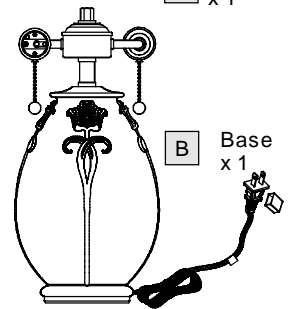

B Base x 1



C Finial x 1



D Cap x 1

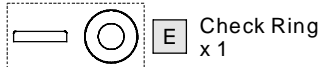

E Check Ring x 1

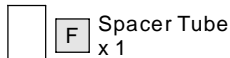

F Spacer Tube x 1

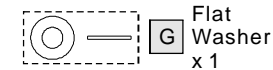

G Flat Washer x 1

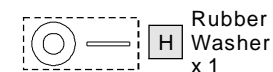

H Rubber Washer x 1

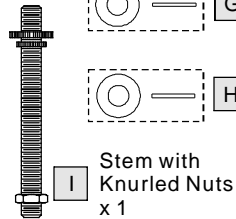

I Stem with Knurled Nuts x 1

STEP 1 - Install Stem with Knurled Nuts

- Remove the Knurled Nuts from the Stem (I).
- Thread the hex nut end of the Stem (I) into the Hex Coupling on the top of the Base (B). By using pliers, thread the hex nut against the Hex Coupling. Hand tighten until snug.

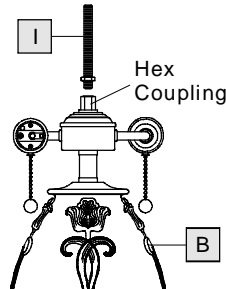

Figure 1

STEP 2 - Install Spacer Tube

- Place the Spacer Tube (F) and the Check Ring (E) over the Stem (I) and secure with the Small Knurled Nut. Hand tighten until snug.

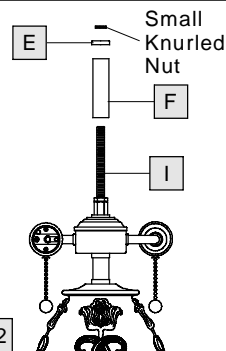

Figure 2

STEP 3 - Install Shade

- Thread the Big Knurled Nut onto the Stem (I) and adjust to proper location for rest components.
- Place the Flat Washer (G), the Rubber Washer (H), the Shade (A) and the Cap (D) over the Stem (I) in turn. Secure by threading the Finial (C) onto the Stem (I). Hand tighten until snug.

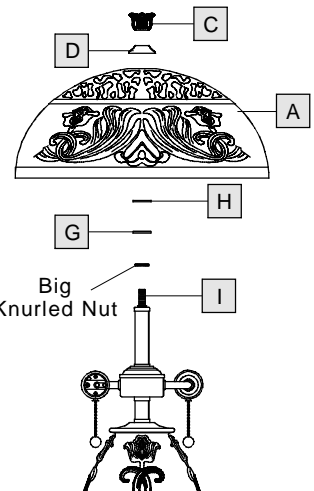

Figure 3

STEP 4 - Install Bulb

- This fixture uses standard bulb with medium base. Maximum 60 watts.
- Insert bulb and screw snugly into place.

Your fixture is now assembled and ready to use. Enjoy!

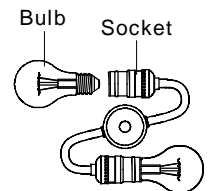
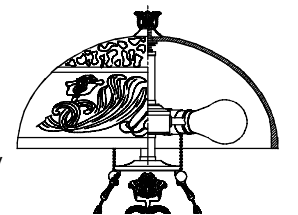

Figure 4

Bottom View

Thank you for purchasing a Quoizel product.
Need assistance with parts or assembly? Call Quoizel customer service at 1-631-273-2700
or visit us on-line at www. quozel. com

QJ6781TR

FINISH: TECO ROSSA

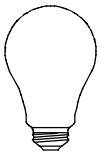
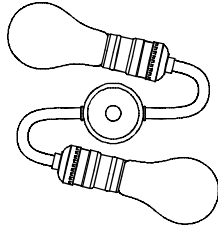

(2) 60W Medium Base Bulbs (Not Supplied)

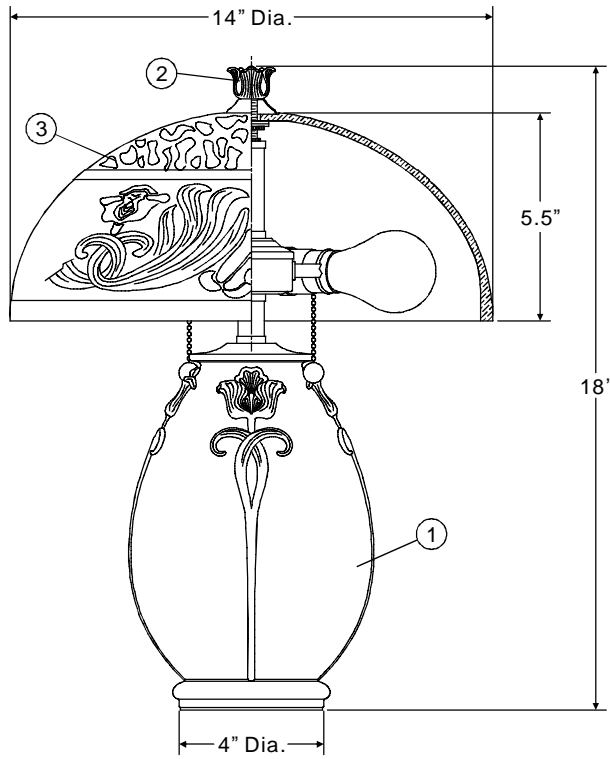

NOTE: ALL DIMENSIONS ARE ROUNDED UP TO THE NEAREST 1/2"

| NO. | PART NUMBER | REPLACEMENT PART DESCRIPTION | REQ. |
|-----|-------------|------------------------------|------|
| 1 | 16781TRQ | BASE TECO ROSSA TABLE LAMP | 1 |
| 2 | M1137FITR | FINIAL TECO ROSA 1.2H X 1.4W | 1 |
| 3 | G6586SH | GLASS ETCHED 14"D QJ6781TR | 1 |

Thank you for purchasing a Quoizel product.
Need assistance with parts or assembly? Call Quoizel customer service at 1-631-273-2700
or visit us on-line at www.quoizel.com