

NUVO LIGHTING



CONTENTS



"Raindrop", a contemporary pendant from Inspired Collections, page 78.



20 **Inspired Collections**
From today's trends to reimagined classical styles, complete collections that inspire a space.

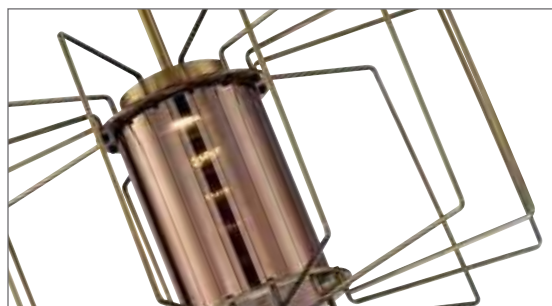

266 **Eclectic Ensembles**
Expressive lighting fixtures that accent and complement design creation.



352 **Project and Functional Lighting**
Fashion and function that exceed expectations across a wide landscape of project applications.



474 **Exterior Expressions**
Create an impression, light the way, outdoor fixtures for everything from style to safety.



556 **Task Lighting**
Elegant function through quality and precision, lighting for coves, under cabinet and track lighting.



On the Cover:
"Boxer", modern farmhouse styled pendant, page 36.

Inspired Collections

Beaker	48
Bento	160
Bliss	32
Bounce	194
Boxer	36
Bridgeview	264
Candice	126
Castillo	256
Celine	136
Chester	220
Connie	154
Crate LED	190
Decker	176
Denver	204
Diesel	120
Donzi	40
Elizabeth	224
Fawn	196
Filigree	110
Frankie	90
Fusion	180
Gemini	112
Ginger	184
Harlow	102
Helium	164
Iron	56
Kettle	54
Krys	74
Laguna	248
Lake	80
Lansing	96
Laurel	60
Loren	152
Marion	24
Meadow	92
Mobili	140
Mystic	88
Nome	212
Odeon	168
Orin	84
Parallel	130
Parker	162
Patton	232
Paxton	70
Payne	38
Polaris	178
Portia	124

Pratt	58
Raindrop LED	78
Seneca	98
Serene	28
Shelby	72
Sherwood	44
Soho	156
Stanza	89
Surrey	148
Teller	144
Vintage	62
Willow	240
Winchester	50

Eclectic Ensembles

Bend LED	314
Bond LED	316
Bow LED	332
Breeze	336
Button LED	346
Chaz LED	306
Dale LED	344
Del LED	278
Doral LED	298
Drum Fixtures LED	349
EMR Flush LED	350
Fantom LED	274
Flush LED	347
Frame LED	292
Grill LED	320
Haley LED	345
Hawk LED	272
Heather LED	343
Jackson LED	312
Jess LED	313
Kinsey LED	307
Lana LED	315
Link	294
Link LED	296
Loop LED	324
Lucas LED	306
Lynne	338
Maxx	304
Mercer LED	310
Orbit LED	288
Pace LED	322
Perk LED	342
Petra LED	307
Pi LED	340

Pulse LED	282
Reflex LED	306
Saber LED	331
Slice LED	328
Slick LED	330
Surf LED	333
Task LED	290
Tex LED	302
Trax LED	309
Tucker LED	319
Vessel LED	300
Vista	337
Votive	334
Wave LED	308
Wired LED	286
Yogi	339
Zen	270
Zorin LED	307

Project and Functional

Blink "Eco" LED	468
Blink "Slim" LED	470
Blink Battery Backup	465
Blink LED	458
Blink Linear LED	469
Blink Plus LED	450
Blink Plus Profile LED	454
Blink Plus Round LED	457
Blink Slim Pendant Kits	471
Chandeliers	354
Close-To-Ceiling	364
Crispo LED	440
Disk Lights LED	472
Flush Mount LED	442
EMR Flush Mount LED	446
Glamour LED	434
Mini Pendants	402
Pendants	396
Range Voltage Flush LED	444
Sconce	432
Strip Lights LED	447
Vanity	404
Vanity / Wall	430
Wraps LED	448

Exterior Expressions

Adams	518
Banyon	520
Bethany LED	494

Boxwood	522
Briton	534
Bulkhead	538
Bulkhead LED	514
Canyon	504
Carport Flush Mounts	546
Central Park	528
Cornerstone	532
Cove Neck	526
Cube	537
Diego LED	496
Drexel	512
Essex LED	502
Genova LED	476
Hood	537
Howell	490
Huron	484
Industrial Style	544
Lakeview	486
Landscape PAR	552
Lansing	482
Onion	536
Outdoor Accessories	554
PAR Floodlights	550
Pathway	553
Piper	536
Poly Coach Wall	549
Porch Wall	548
Stanton	506
Step Lights LED	516
Tanner	492
Up/Down LED	515
Urbino LED	477
Utility Wall & Ceiling	546
Vega	510
Verona LED	480
Willis LED	500
Wingate	508

Task Lighting

Thread Linear Led	558
Led Track Heads	562
Led Track Kits	570
Thread Accessories	561
Track & Accessories	578
Track Heads	574
Track Kits	572

Index	580
-------	-----

Nuvo Lighting:
A legacy of
lighting solutions.





Nuvo Lighting: Impressive, everywhere.

Taking every space,
every décor,
from average
to amazing.



Breadth of line. It's a simple enough idea, but one not easily achieved. Nuvo Lighting has been able to develop beautifully designed, highly engineered fixtures, in a range of styles and technologies, including many LED options, that are at home

anywhere from condos to cottages, homes to hospitality venues, indoors or out. As you review the many families in this book, you'll soon discover that "breadth of line" – an elusive goal for most lighting companies – is an understatement at Nuvo Lighting.



"Marion", page 24

Fantastic families.

Complete fixture families mean design continuity.



Whole-house coordination requires a big picture look at the entire residence – and finding the right fixture family to go the distance. Nuvo Lighting

has many fixture families in a number of styles that provide this high level of flexibility and versatility – fixtures in one family for many applications.



"Sherwood", page 44

Can a fixture define the room?

We believe so. And to our point, these beautiful kitchens.



The lighting in any room can make a statement, but should not overshadow the room's overall beauty. Tasteful design – in any style – can achieve that.

Nuvo Lighting has the solution – many varied design disciplines that can make a statement in any room, but do it with tasteful restraint.



- A. "Stanza", page 89
- B. "Thread", undercounter lighting page 558
- C. "Zen", page 270
- D. "Vessel", page 300
- E. "Boxer", page 36

Sconces! Vanities!

Is there a space these fixtures can't complement?



With so many beautiful, LED efficient vanity and sconce options, it's no wonder condo developers, home builders and hospitality planners

everywhere rely on Nuvo Lighting for their design and energy savings. Professionals rely on Nuvo Lighting; residents enjoy it.



A. "Slick", page 330
 B. "Chaz", page 306
 C. "Loop", page 324, "Perk" flush mount, (also shown), page 342
 D. "Lucas", page 306
 E. "Saber", page 331

Impressive first impressions.

Curb appeal isn't just about selling homes – and it isn't just for the daylight hours.



In addition to safety, the right lighting can make a home come alive all over again after the sun sets. With so many

styles and families to choose from, Nuvo outdoor fixtures have made lasting impressions – all day long.



- A. "Willis", page 500
- B. "Verona", page 480
- C. "Wingate", page 508
- D. "Howell", page 490

Functional, Versatile. Efficient.

Nuvo covers the basics, in style.



With all the utility fixtures Nuvo Lighting offers, there's no reason every space can't have efficient, cleanly-designed LED lighting. From garage to laundry to workshop,

closet to craft room to mud room, every space will benefit from the right lighting – the wide variety of functional Nuvo LED track and utility lighting



B



C



D



E

- A. Disk lights, page 472
- B. "Blink Plus Profile", page 454
- C. "Ballerina", page 360
- D. Track lights, page 562
- E. Flush utility lights, page 442

Re-thinking hospitality.

Hospitality is not
just an industry
term, it's a feeling.



Rather than define the hospitality industry as just that, an industry, we define it another way: warm, inviting, comfortable, stylish, and all the thoughts that come to mind when we think of inviting spaces. But still being a business, Nuvo fixtures

also help this industry meet energy requirements and maintenance costs with our focus on LED fixture families.

Nuvo Lighting can achieve true hospitality – and savings – in any number of styles and applications.



B

A. "Slice", page 328
B. "Del", page 278

Inspired
Collections







LASTING IMPRESSIONS.

Simple design is hard to achieve. But when done correctly, the result is both elegant and impressive. The Marion Collection is just that.



MARION

Aged Bronze / Natural Brass



60-6525



60-6523



60-6522

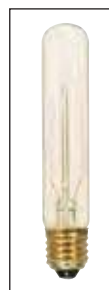

*T9 Vintage lamps included

Item#	Description	Finish	No. of Lights	Lamp Type	Base	Max Watts	Length	Width	Height	Ext.	Cert. Type
60-6521	Sconce	Aged Bronze / Natural Brass	1	T9*	Med.	60W	•	6 1/2"	16"	6"	Damp
60-6522	Mini Pendant	Aged Bronze / Natural Brass	1	T9*	Med.	60W	•	8"	16"	•	Dry
60-6523	Flush†	Aged Bronze / Natural Brass	4	T9*	Med.	60W	•	13 3/4"	11 7/8"	•	Damp
60-6525	Chandelier	Aged Bronze / Natural Brass	4	T9*	Med.	60W	•	15"	22"	•	Dry
60-6526	Island Pendant	Aged Bronze / Natural Brass	7	T9*	Med.	60W	36"	16"	15"	•	Dry

*20W T9 S2415 Vintage lamps included.

Additional chain: (3') 25-5004, †Pendant conversion kit for flush: 25-5013, Additional Stems: (6") 25-4066, (12") 25-4067. Chandelier flush and pendants include 12' of wire.



60-6521



60-6526



A QUIET PRESENCE.

The Serene fixture family is just that – elegant Satin White glass and delicately shaped Natural Brass combine to create a reserved yet impactful design statement. Serene fixtures quietly go about enhancing any room lucky enough to have them.



SERENE

Natural Brass / Satin White Glass

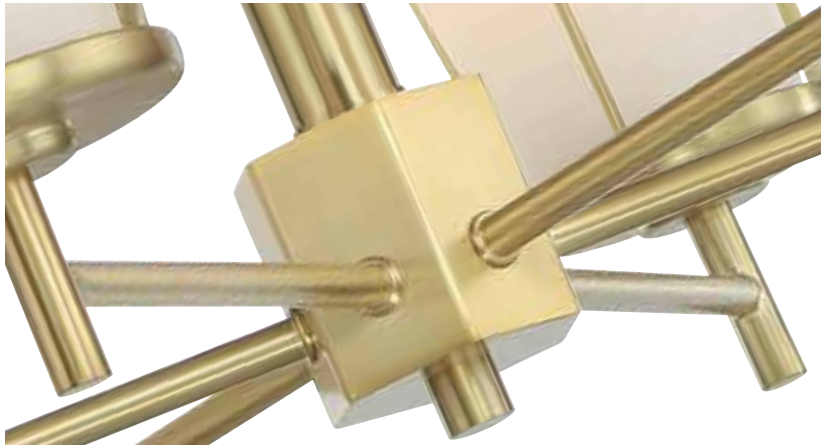

60-6534



60-6537



60-6535



60-6536

Item#	Description	Finish	No. of Lights	Lamp Type	Base	Max Watts	Length	Width	Height	Ext.	Cert. Type
60-6531	1 Lt. Vanity	Natural Brass	1	A19	Med.	100W	•	4 ¾"	9 ¾"	6 ½"	Damp
60-6532	2 Lt. Vanity	Natural Brass	2	A19	Med.	100W	•	14"	9 ¾"	6 ½"	Damp
60-6533	3 Lt. Vanity	Natural Brass	3	A19	Med.	100W	•	22"	9 ¾"	6 ½"	Damp
60-6534	4 Lt. Chandelier	Natural Brass	4	A19	Med.	100W	•	19 ½"	17"	•	Dry
60-6535	Mini Pendant	Natural Brass	1	A19	Med.	100W	•	4 ¾"	8 ¼"	•	Dry
60-6536	6 Lt. Chandelier	Natural Brass	6	A19	Med.	100W	•	26"	24"	•	Dry
60-6537	Flush	Natural Brass	2	A19	Med.	100W	•	12 7/8"	6 ¼"	•	Damp
60-6538	Island Pendant	Natural Brass	6	A19	Med.	100W	36"	20"	8 ¼"	•	Dry

Vanity fixtures CUL listed for glass up or down installation.

Additional chain: (3') 25-5003, Additional Stems: (6") 25-5006, (12") 25-5007. Chandeliers and pendants include 12' of wire and 4' of chain, where applicable.



60-6531



60-6533



60-6532



60-6538



UNIQUE PAIRING. BEAUTIFUL RESULT.

A bit rustic, a bit elegant, Bliss captures the imagination with a Driftwood frame, supported by tasteful Polished Nickel accents.



BLISS

Polished Nickel / Driftwood



60-6483



60-6484*

Item#	Description	Finish	No. of Lights	Lamp Type	Base	Max Watts	Length	Width	Height	Ext.	Cert. Type
60-6481	Pendant	Polished Nickel / Driftwood	4	Type B	Cand.	60W	•	11 5/8"	28 5/8"	•	Dry
60-6482	Flush	Polished Nickel / Driftwood	2	A19*	Med.	60W	•	12 1/2"	5 1/2"	•	Damp
60-6483	Pendant	Polished Nickel / Driftwood	4	Type B	Cand.	60W	•	13 3/4"	36 3/8"	•	Dry
60-6484	Mini Pendant	Polished Nickel / Driftwood	1	A19*	Med.	60W	•	6 3/4"	15 3/8"	•	Dry

*60W ST19 S2423 Vintage lamps included.

Additional Stems: (6") 25-4118, (12") 25-4119.



60-6481



60-6482*



*ST19 Vintage lamps included



TASTEFUL COMBINATIONS.

Matte Black, Antique Silver and Satin White Glass combine to create Boxer – not just great design, but a presence in any venue. Simple, tasteful, elegant, all at once.

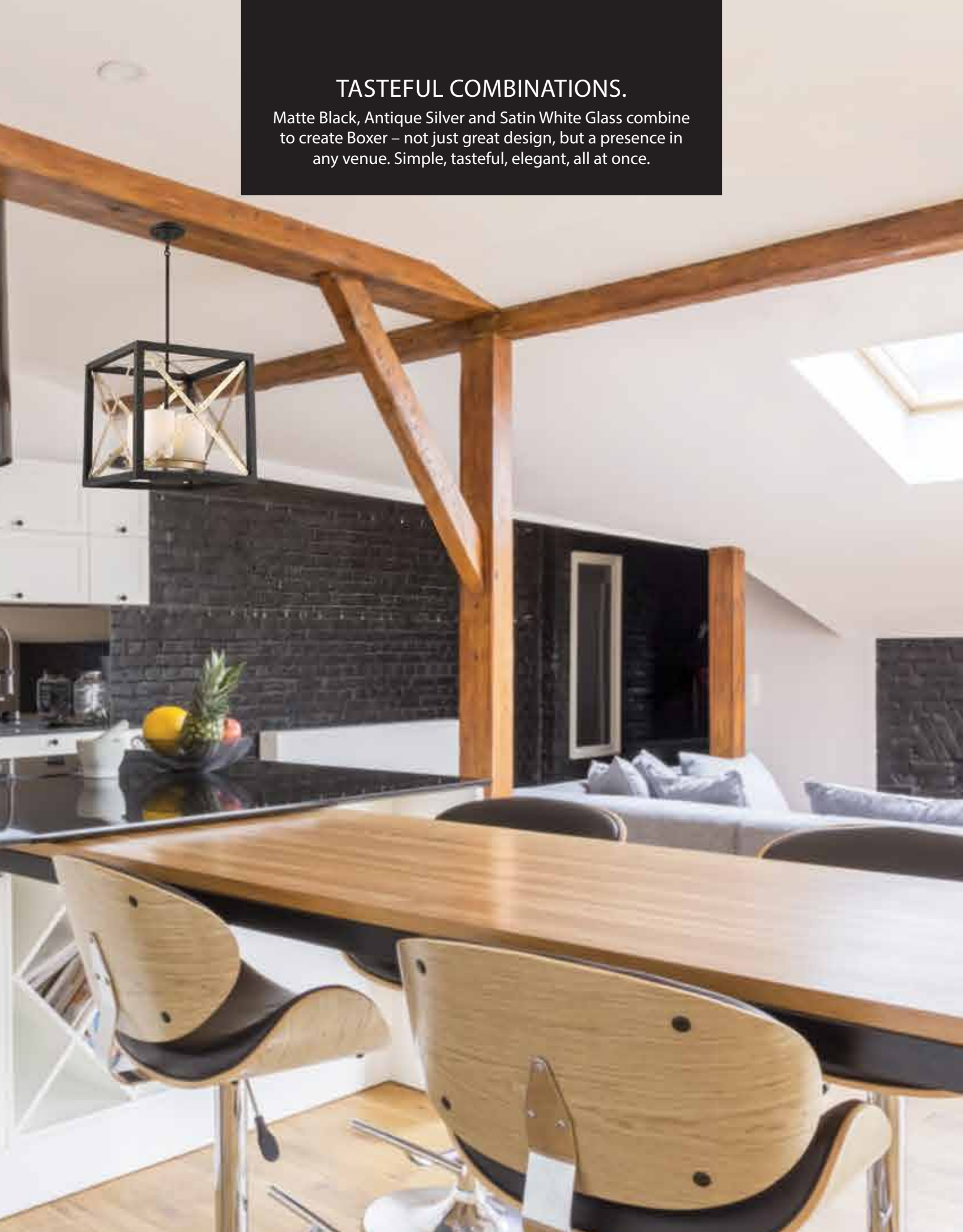

BOXER

Matte Black with Antique Silver Accents / Satin White Glass



60-6132



60-6135



60-6134

Item#	Description	Finish	No. of Lights	Lamp Type	Base	Max Watts	Length	Width	Height	Ext.	Cert. Type
60-6131	Sconce	Matte Black / Ant. Silver	1	A19	Med.	100W	•	7"	10"	6"	Damp
60-6132	Flush	Matte Black / Ant. Silver	2	A19	Med.	100W	•	14"	6 ¼"	•	Damp
60-6133	Island Pendant	Matte Black / Ant. Silver	3	A19	Med.	100W	38"	5 ½"	10 ¾"	•	Dry
60-6134	Pendant	Matte Black / Ant. Silver	4	A19	Med.	100W	•	17"	17"	•	Dry
60-6135	Mini Pendant	Matte Black / Ant. Silver	1	A19	Med.	100W	•	7 ½"	10 ¾"	•	Dry

Additional Stems: (6") 25-6135, (12") 25-6136.
Pendants include 12' of wire.



60-6131



60-6133

PAYNE

Midnight Bronze / Vintage Brass Accents / Clear Beveled Glass



60-6415



60-6412



60-6411



60-6414



*T9 Vintage lamps included

Item#	Description	Finish	No. of Lights	Lamp Type	Base	Max Watts	Length	Width	Height	Ext.	Cert. Type
60-6411	Sconce	Midnight Bronze	1	G25	Med.	60W	•	8"	8"	5 ½"	Damp
60-6412	Mini Pendant	Midnight Bronze	1	G25	Med.	60W	•	6 ½"	8 ½"	•	Dry
60-6413	Semi-flush†	Midnight Bronze	4	G25	Med.	60W	•	17 ½"	11 ⅝"	•	Dry
60-6414	4 Lt. Pendant	Midnight Bronze	4	G25	Med.	60W	•	22"	8"	•	Dry
60-6415	Foyer	Midnight Bronze	5	T9*	Med.	60W	•	14"	20 ¾"	•	Dry
60-6416	5 Lt. Pendant	Midnight Bronze	5	G25	Med.	60W	•	26"	12 ½"	•	Dry
60-6417	Island Pendant	Midnight Bronze	4	G25	Med.	60W	42"	10"	9"	•	Dry

*60W T9 S2422 Vintage lamps included.

†Pendant conversion kit for semi-flush: **25-6418**, Additional Stems: (6") **25-6416**, (12") **25-6417**. Semi-flush and pendants include 12' of wire.



60-6413



60-6416



60-6417

DONZI

Iron Black / Clear Seeded Glass



60-6387



60-6381



60-6382



*T9 Vintage lamps included

Item#	Description	Finish	No. of Lights	Lamp Type	Base	Max Watts	Length	Width	Height	Ext.	Cert. Type
60-6381	Sconce	Iron Black	1	T9*	Med.	60W	•	4 1/2"	12 7/8"	4 3/8"	Damp
60-6382	Vanity	Iron Black	2	T9*	Med.	60W	•	27 1/2"	4 1/2"	4 3/8"	Damp
60-6383	3 Lt. Chandelier	Iron Black	3	T9*	Med.	60W	•	17"	17 1/4"	•	Dry
60-6385	5 Lt. Chandelier	Iron Black	5	T9*	Med.	60W	•	25"	17 1/4"	•	Dry
60-6387	7 Lt. Chandelier	Iron Black	7	T9*	Med.	60W	•	33"	17 1/4"	•	Dry

*60W T9 S2422 Vintage lamps included.

Additional Stems: (6") 25-6261, (12") 25-6262.
Pendants include 12' of wire.



60-6383



60-6385



RUSTIC, REFINED ELEGANCE

With Iron Black and Brushed Nickel accents, Sherwood embodies the rustic and refined trend, elegantly.



SHERWOOD

Iron Black / Brushed Nickel Accents / Clear or Frosted Etched Glass



60-6128*



60-6125

Item#	Description	Finish	No. of Lights	Lamp Type	Base	Max Watts	Length	Width	Height	Ext.	Cert. Type
60-6125	Pendant	Iron Black / Br. Nickel	4	A19	Med.	60W	•	25 7/8"	27 1/8"	•	Dry
60-6126	Flush	Iron Black / Br. Nickel	2	A19	Med.	60W	•	14 3/4"	6 5/8"	•	Damp
60-6127	Open Cage Foyer	Iron Black / Br. Nickel	4	T9*	Med.	60W	•	17"	35 1/2"	•	Dry
60-6128	Chandelier	Iron Black / Br. Nickel	8	T9*	Med.	60W	25"	25"	33 3/8"	•	Dry

*40W T9 S2426 Vintage lamps included.
Chandeliers, pendants and foyer fixtures include 12' of wire and 4' of chain where applicable.

Additional chain: (3) 25-6125.



60-6127*



60-6126

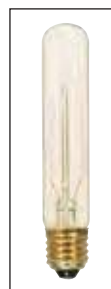

*T9 Vintage lamps included

SHERWOOD

Iron Black / Brushed Nickel Accents / Clear Glass



60-6124



* T9 Vintage lamps included

Item#	Description	Finish	No. of Lights	Lamp Type	Base	Max Watts	Length	Width	Height	Ext.	Cert. Type
60-6121	Sconce	Iron Black / Br. Nickel	1	T9*	Med.	60W	•	5 1/2"	11 5/8"	5 7/8"	Damp
60-6122	2 Lt. Vanity	Iron Black / Br. Nickel	2	T9*	Med.	60W	•	16"	10 3/8"	5 7/8"	Damp
60-6123	3 Lt. Vanity	Iron Black / Br. Nickel	3	T9*	Med.	60W	•	24"	10 3/8"	8 5/8"	Damp
60-6124	Island Pendant	Iron Black / Br. Nickel	6	T9*	Med.	60W	38"	14"	24"	•	Dry
60-6129	4 Lt. Vanity	Iron Black / Br. Nickel	4	T9*	Med.	60W	•	32"	10 3/8"	8 5/8"	Damp

*40W T9 S2426 Vintage lamps included.

Additional chain: (3') 25-6125
Pendant includes 12' of wire and 4' of chain.



60-6123



60-6121



60-6129



60-6122

BEAKER

Brushed Nickel or Aged Bronze / Clear Glass



60-5265



60-5262



60-5261



60-5264



60-5263
(vertical or horizontal mounting)

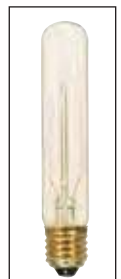

*T9 Vintage
lamps included

Item#	Description	Finish	No. of Lights	Lamp Type	Base	Max Watts	Length	Width	Height	Ext.	Cert. Type
60-5261	Sconce	Brushed Nickel	1	T9*	Med.	60W	•	5 1/2"	14 1/8"	5"	Damp
60-5262	Mini Pendant	Brushed Nickel	1	T9*	Med.	60W	•	4 3/4"	14 1/2"	•	Dry
60-5263	Vanity	Brushed Nickel	2	T9*	Med.	60W	•	23 3/4"	4 3/4"	5 7/8"	Damp
60-5264	Pendant	Brushed Nickel	4	T9*	Med.	60W	•	26"	9 1/2"	•	Dry
60-5265	Trestle	Brushed Nickel	4	T9*	Med.	60W	36"	4 3/4"	13 1/2"	•	Dry
60-5361	Sconce	Aged Bronze	1	T9*	Med.	60W	•	5 1/2"	14 1/8"	5"	Damp
60-5362	Mini Pendant	Aged Bronze	1	T9*	Med.	60W	•	4 3/4"	14 1/2"	•	Dry
60-5363	Vanity	Aged Bronze	2	T9*	Med.	60W	•	23 3/4"	4 3/4"	5 7/8"	Damp
60-5364	Pendant	Aged Bronze	4	T9*	Med.	60W	•	26"	9 1/2"	•	Dry
60-5365	Trestle	Aged Bronze	4	T9*	Med.	60W	36"	4 3/4"	13 1/2"	•	Dry

*20W T9 S2415 Vintage lamps included.

Additional Stems (Brushed Nickel): (6") 25-2057, (12") 25-2055,
 Additional Stems (Aged Bronze): (6") 25-4066, (12") 25-4067.
 Pendants and Trestle include 12' of wire.



60-5365

60-5362

60-5361

60-5364

60-5363
 (vertical or horizontal mounting)

WINCHESTER

Bronze / Aged Wood



60-6426



60-6425

Item#	Description	Finish	No. of Lights	Lamp Type	Base	Max Watts	Length	Width	Height	Ext.	Cert. Type
60-6421	Mini Pendant	Bronze / Aged Wood	1	A19*	Med.	60W	10 3/4"	10 3/4"	14 3/4"	•	Dry
60-6422	Pendant	Bronze / Aged Wood	4	A19*	Med.	60W	18 3/4"	18 3/4"	15 1/4"	•	Dry
60-6423	Pendant	Bronze / Aged Wood	4	A19*	Med.	60W	15"	15"	14 3/4"	•	Dry
60-6425	Pendant	Bronze / Aged Wood	2	A19*	Med.	60W	11 1/4"	11 1/4"	21"	•	Dry
60-6426	Pendant	Bronze / Aged Wood	4	A19*	Med.	60W	14 3/4"	14 3/4"	25 1/2"	•	Dry

*60W ST19 S2423 Vintage lamps included.

Additional chain: (3) 25-6423. Pendants include 12' of wire and 4' of chain.



60-6421

60-6422

60-6423



*ST19 Vintage lamps included

WINCHESTER

Bronze / Aged Wood



60-6424



*ST19 Vintage
lamps included

Item#	Description	Finish	No. of Lights	Lamp Type	Base	Max Watts	Length	Width	Height	Ext.	Cert. Type
60-6424	Island Pendant	Bronze / Aged Wood	4	A19*	Med.	60W	40 3/4"	10 3/4"	15 1/4"	•	Dry
60-6427	1 Lt. Vanity	Bronze / Aged Wood	1	A19*	Med.	60W	•	5"	13 3/8"	3 7/8"	Damp
60-6428	2 Lt. Vanity	Bronze / Aged Wood	2	A19*	Med.	60W	•	16 3/8"	8 5/8"	5 3/4"	Damp
60-6429	3 Lt. Vanity	Bronze / Aged Wood	3	A19*	Med.	60W	•	24"	8 5/8"	5 3/4"	Damp
60-6430	4 Lt. Vanity	Bronze / Aged Wood	4	A19*	Med.	60W	•	32 1/8"	8 5/8"	5 3/4"	Damp

*60W ST19 S2423 Vintage lamps included.
Vanity fixtures CUL listed for up or down installation.

Additional chain: (3) 25-6423.
Pendant includes 12' of wire and 4' of chain.



60-6427



60-6429



60-6428



60-6430

KETTLE

Weathered Brass



60-5895



60-5891

Item#	Description	Finish	No. of Lights	Lamp Type	Base	Max Watts	Length	Width	Height	Ext.	Cert. Type
60-5891	Sconce	Weathered Brass	1	A19*	Med.	60W	•	12"	8"	5"	Damp
60-5892	Mini Pendant	Weathered Brass	1	A19*	Med.	60W	•	7 1/8"	7"	•	Dry
60-5893	Flush	Weathered Brass	3	A19*	Med.	60W	•	12"	8"	•	Dry
60-5894	Pendant	Weathered Brass	4	A19*	Med.	60W	•	20"	9"	•	Dry
60-5895	Oversized Pendant	Weathered Brass	5	A19*	Med.	60W	•	30"	28"	•	Dry

*60W ST19 S2423 Vintage lamps included.

Additional chain: (3') 25-5895, Additional Stems: (6") 25-5892, (12") 25-5893. Chandelier and pendants include 12' of wire and 4' of chain where applicable.



IRON

Industrial Bronze



60-5794

Item#	Description	Finish	No. of Lights	Lamp Type	Base	Max Watts	Length	Width	Height	Ext.	Cert. Type
60-5791	Sconce	Industrial Bronze	1	A19*	Med.	60W	•	5"	7"	7"	Damp
60-5792	2 Lt. Vanity	Industrial Bronze	2	A19*	Med.	60W	•	20"	7"	7"	Damp
60-5793	3 Lt. Vanity	Industrial Bronze	3	A19*	Med.	60W	•	24 ½"	7"	7"	Damp
60-5794	Trestle	Industrial Bronze	4	A19*	Med.	60W	•	27"	36 ½"	•	Dry
60-5795	5 Lt. Pendant	Industrial Bronze	5	A19*	Med.	60W	•	27"	17"	•	Dry

*60W ST19 S2423 Vintage lamps included.
Vanity fixtures CUL listed for up or down installation.

Additional chain: (3) 25-5795.
Trestle and Hanging fixtures include 12' of wire.



60-5792



60-5791



60-5795



60-5793



*ST19 Vintage lamps included

PRATT

Black / Brushed Nickel Accents / Frosted Glass



60-6452

60-6455

Item#	Description	Finish	No. of Lights	Lamp Type	Base	Max Watts	Length	Width	Height	Ext.	Cert. Type
60-6451	Mini Pendant	Black / Brushed Nickel	1	A19	Med.	100W	•	8"	12 ¾"	•	Dry
60-6452	Flush	Black / Brushed Nickel	3	A19	Med.	100W	•	16 ¾"	7"		Damp
60-6453	3 Lt. Pendant	Black / Brushed Nickel	3	A19	Med.	100W	•	20"	13 ½"		Dry
60-6454	5 Lt. Pendant	Black / Brushed Nickel	5	A19	Med.	100W	•	26"	13 ½"	•	Dry
60-6455	Island Pendant	Black / Brushed Nickel	4	A19	Med.	100W	38 ¾"	10"	13 ½"	•	Dry

Additional Stems: (6") 25-2057, (12") 25-2055.
Pendants include 12' of wire.



60-6451



60-6454



60-6453

LAUREL

Sudbury Bronze / Clear Seeded Glass



60-5546



60-5544



60-5545

Item#	Description	Finish	No. of Lights	Lamp Type	Base	Max Watts	Length	Width	Height	Ext.	Cert. Type
60-5541	1 Lt. Vanity	Sudbury Bronze	1	A19	Med.	60W	•	5 ¼"	13 ¾"	6 ¼"	Damp
60-5542	2 Lt. Vanity	Sudbury Bronze	2	A19	Med.	60W	•	12 ⅞"	12 ⅞"	5 ½"	Damp
60-5543	3 Lt. Vanity	Sudbury Bronze	3	A19	Med.	60W	•	19 ⅞"	12 ⅞"	5 ¼"	Damp
60-5544	Semi-flush†	Sudbury Bronze	3	A19	Med.	60W	•	15 ½"	15 ⅞"	•	Dry
60-5545	5 Lt. Chandelier	Sudbury Bronze	5	A19	Med.	60W	•	22 ½"	25 ¼"	•	Dry
60-5546	3 Lt. Chandelier	Sudbury Bronze	3	A19	Med.	60W	•	21 ½"	23 ⅞"	•	Dry
60-5547	Pendant	Sudbury Bronze	3	A19	Med.	60W	•	15 ½"	25 ¼"	•	Dry
60-5548	Trestle	Sudbury Bronze	4	A19	Med.	60W	35 ¾"	5 ¼"	29"	•	Dry

Vanity fixtures CUL listed for glass up or down installation.

Additional chain: (3') 25-3023, †Pendant conversion kit for semi-flush: 25-4096
Chandelier, pendant, Trestle and semi-flush fixtures include 12' of wire and 4' of chain where applicable.



60-5547



60-5548



60-5542



60-5541



60-5543

VINTAGE

Polished Nickel / Clear or Ribbed Glass



60-5407



60-5411



60-5408



60-5401



*ST19 Vintage lamps included

Item#	Description	Finish	No. of Lights	Lamp Type	Base	Max Watts	Length	Width	Height	Ext.	Cert. Type
60-5401	Pendant	Polished Nickel	1	A19*	Med.	100W	•	7 3/8"	10 3/4"	•	Dry
60-5406	Pendant	Polished Nickel	1	A19*	Med.	100W	•	14"	6 3/4"	•	Dry
60-5407	Pendant	Polished Nickel	1	A19*	Med.	100W	•	14"	6 3/8"	•	Dry
60-5408	Pendant	Polished Nickel	1	A19*	Med.	100W	•	14"	6 3/8"	•	Dry
60-5409	Pendant	Polished Nickel	1	A19*	Med.	100W	•	14"	6 1/2"	•	Dry
60-5411	Pendant	Polished Nickel	1	A19*	Med.	100W	•	7 3/4"	8 1/4"	•	Dry
60-5416	Pendant	Polished Nickel	1	A19*	Med.	100W	•	14"	6"	•	Dry

*40W ST19 S2413 Vintage lamps included.

Pendants include 12' of black rayon cord.



60-5406



60-5416



60-5409

VINTAGE

Polished Nickel / Clear Glass



60-5402



60-5412



60-5404



60-5414



*ST19 Vintage lamps included

Item#	Description	Finish	No. of Lights	Lamp Type	Base	Max Watts	Length	Width	Height	Ext.	Cert. Type
60-5402	Pendant	Polished Nickel	1	A19*	Med.	100W	•	6 1/2"	8 5/8"	•	Dry
60-5403	Pendant	Polished Nickel	1	A19*	Med.	100W	•	7"	8 5/8"	•	Dry
60-5404	Pendant	Polished Nickel	1	A19*	Med.	100W	•	5 1/8"	8 5/8"	•	Dry
60-5405	Pendant	Polished Nickel	1	A19*	Med.	100W	•	4 7/8"	8"	•	Dry
60-5412	Sconce	Polished Nickel	1	A19*	Med.	100W	•	6 1/2"	9 3/4"	7 5/8"	Damp
60-5413	Sconce	Polished Nickel	1	A19*	Med.	100W	•	7"	9 3/4"	7 7/8"	Damp
60-5414	Sconce	Polished Nickel	1	A19*	Med.	100W	•	5 1/8"	9 3/4"	6 1/8"	Damp
60-5415	Sconce	Polished Nickel	1	A19*	Med.	100W	•	4 7/8"	9"	4 3/4"	Damp

*40W ST19 S2413 Vintage lamps included.

Vanity fixtures CUL listed for glass up or down installation.

Pendants include 12' of black rayon cord.



60-5403



60-5413



60-5405



60-5415

VINTAGE

Rustic Bronze / Clear or Ribbed Glass



60-5507



60-5511



60-5508



60-5501



*ST19 Vintage lamps included

Item#	Description	Finish	No. of Lights	Lamp Type	Base	Max Watts	Length	Width	Height	Ext.	Cert. Type
60-5501	Pendant	Rustic Bronze	1	A19*	Med.	100W	•	7 3/8"	10 3/4"	•	Dry
60-5506	Pendant	Rustic Bronze	1	A19*	Med.	100W	•	14"	6 3/4"	•	Dry
60-5507	Pendant	Rustic Bronze	1	A19*	Med.	100W	•	14"	6 3/4"	•	Dry
60-5508	Pendant	Rustic Bronze	1	A19*	Med.	100W	•	14"	6 3/8"	•	Dry
60-5509	Pendant	Rustic Bronze	1	A19*	Med.	100W	•	14"	6 1/2"	•	Dry
60-5511	Pendant	Rustic Bronze	1	A19*	Med.	100W	•	7 3/4"	8 1/4"	•	Dry
60-5516	Pendant	Rustic Bronze	1	A19*	Med.	100W	•	14"	6"	•	Dry

*40W ST19 S2413 Vintage lamps included.

Pendants include 12' of brown rayon cord.



60-5506



60-5516



60-5509

VINTAGE

Polished Nickel / Clear Glass



60-5502



60-5512



60-5514



60-5504



*ST19 Vintage lamps included

Item#	Description	Finish	No. of Lights	Lamp Type	Base	Max Watts	Length	Width	Height	Ext.	Cert. Type
60-5502	Pendant	Rustic Bronze	1	A19*	Med.	100W	•	6 1/2"	8 5/8"	•	Dry
60-5503	Pendant	Rustic Bronze	1	A19*	Med.	100W	•	7"	8 5/8"	•	Dry
60-5504	Pendant	Rustic Bronze	1	A19*	Med.	100W	•	5 1/8"	8 5/8"	•	Dry
60-5505	Pendant	Rustic Bronze	1	A19*	Med.	100W	•	4 7/8"	8"	•	Dry
60-5512	Sconce	Rustic Bronze	1	A19*	Med.	100W	•	6 1/2"	9 3/4"	7 5/8"	Damp
60-5513	Sconce	Rustic Bronze	1	A19*	Med.	100W	•	7"	9 3/4"	7 7/8"	Damp
60-5514	Sconce	Rustic Bronze	1	A19*	Med.	100W	•	5 1/8"	9 3/4"	6 1/8"	Damp
60-5515	Sconce	Rustic Bronze	1	A19*	Med.	100W	•	4 7/8"	9"	4 3/4"	Damp

*40W ST19 S2413 Vintage lamps included.
 Vanity fixtures CUL listed for glass up or down installation.

Pendants include 12' of brown rayon cord.



60-5503



60-5513



60-5505



60-5515

PAXTON

Natural Brass or Aged Bronze Finish



60-5715



60-5711



60-5713



60-5712

Item#	Description	Finish	No. of Lights	Lamp Type	Base	Max Watts	Length	Width	Height	Ext.	Cert. Type
60-5711	Sconce	Natural Brass	1	A19*	Med.	100W	•	6 ¾"	9 ¾"	4"	Damp
60-5712	Mini Pendant	Natural Brass	1	A19*	Med.	100W	•	5"	10 7/8"	•	Dry
60-5713	Pendant	Natural Brass	3	A19*	Med.	100W	•	13 ½"	11 ¾"	•	Dry
60-5715	Chandelier	Natural Brass	5	A19*	Med.	100W	•	27 ¾"	23 ¾"	•	Dry
60-5721	Sconce	Aged Bronze	1	A19*	Med.	100W	•	6 ¾"	9 ¾"	4"	Damp
60-5722	Mini Pendant	Aged Bronze	1	A19*	Med.	100W	•	5"	10 7/8"	•	Dry
60-5723	Pendant	Aged Bronze	3	A19*	Med.	100W	•	13 ½"	11 ¾"	•	Dry
60-5725	Chandelier	Aged Bronze	5	A19*	Med.	100W	•	27 ¾"	23 ¾"	•	Dry

*40W ST19 S2413 Vintage lamps included.
Sconces CUL listed for up or down installation.

Additional Stems (Natural Brass): (6") 25-4151, (12") 25-4152,
Additional Stems (Aged Bronze): (6") 25-4066, (12") 25-4067.
Chandeliers and pendants include 12' wire.



60-5722



60-5723



60-5721



60-5725



*ST19 Vintage lamps included

SHELBY

Polished Nickel / Clear Beveled Glass



60-6294



60-6293



60-6292



*ST19 or **T9 Vintage lamps included

Item#	Description	Finish	No. of Lights	Lamp Type	Base	Max Watts	Length	Width	Height	Ext.	Cert. Type
60-6291	Sconce	Polished Nickel	1	A19*	Med.	60W	•	4 7/8"	8 1/8"	4 1/2"	Dry
60-6292	Foyer	Polished Nickel	4	A19*	Med.	60W	•	12 3/4"	18 1/2"	•	Dry
60-6293	Pendant	Polished Nickel	4	T9**	Cand.	60W	•	10 5/8"	10"	•	Dry
60-6294	Pendant	Polished Nickel	4	A19*	Med.	60W	•	20"	7 5/8"	•	Dry
60-6295	Island Pendant	Polished Nickel	4	A19*	Med.	60W	38"	10 5/8"	9 5/8"	•	Dry

*60W ST19 S2423 Vintage lamps included.
 **40W T9 S2420 Vintage lamps included.

Additional Stems: (6") 25-4118, (12") 25-4119.
 Pendants include 12' of wire.



60-6291

60-6295

KRYS

Polished Nickel / Clear Prism



60-5761



60-5764



60-5762



*ST19 or **T9 Vintage lamps included

Item#	Description	Finish	No. of Lights	Lamp Type	Base	Max Watts	Length	Width	Height	Ext.	Cert. Type
60-5761	Pendant	Polished Nickel	4	A19*	Med.	60W	•	24 5/8"	20 1/2"		Dry
60-5762	Foyer	Polished Nickel	4	T9**	Cand.	60W	•	14 5/8"	26 1/4"	•	Dry
60-5763	Semi-flush†	Polished Nickel	2	A19*	Med.	60W	•	17 3/4"	12 1/8"	•	Dry
60-5764	Mini Pendant	Polished Nickel	1	A19*	Med.	60W	•	7 7/8"	11 3/4"	•	Dry
60-5765	Trestle	Polished Nickel	4	A19*	Med.	60W	36 3/4"	10"	23 1/8"	•	Dry
60-5766	Short Sconce	Polished Nickel	1	A19*	Med.	60W	•	8 1/4"	12 3/4"	4 3/4"	Damp
60-5767	Long Sconce	Polished Nickel	1	A19*	Med.	60W	•	10 1/4"	22 3/4"	5 3/8"	Damp

*60W ST19 S2423 Vintage lamps included.
 **40W T9 S2420 Vintage lamps included.

Additional chain: (3') 25-4141, †Pendant conversion kit for semi-flush: 25-4143,
 Additional Stems: (6") 25-4118, (12") 25-4119.
 Pendants trestle and Semi-flush include 12' of wire and 4' of chain where applicable.



60-5763



60-5767



60-5766



60-5765

KRYS

Aged Bronze / Clear Prisms



60-5771



60-5774



60-5772



*ST19 or **T9 Vintage lamps included

Item#	Description	Finish	No. of Lights	Lamp Type	Base	Max Watts	Length	Width	Height	Ext.	Cert. Type
60-5771	Pendant	Aged Bronze	4	A19*	Med.	60W	•	24 5/8"	20 1/2"	•	Dry
60-5772	Foyer	Aged Bronze	4	T9**	Cand.	60W	•	14 5/8"	26 1/4"	•	Dry
60-5773	Semi-flush†	Aged Bronze	2	A19*	Med.	60W	•	17 3/4"	12 1/8"	•	Dry
60-5774	Mini Pendant	Aged Bronze	1	A19*	Med.	60W	•	7 7/8"	11 3/4"	•	Dry
60-5775	Trestle	Aged Bronze	4	A19*	Med.	60W	36 3/4"	10"	23 1/8"	•	Dry
60-5776	Short Sconce	Aged Bronze	1	A19*	Med.	60W	•	8 1/4"	12 3/4"	4 3/4"	Damp
60-5777	Long Sconce	Aged Bronze	1	A19*	Med.	60W	•	10 1/4"	22 3/4"	5 3/8"	Damp

*60W ST19 S2423 Vintage lamps included.
 **40W T9 S2420 Vintage lamps included.

Additional chain: (3') 25-4058, †Pendant conversion kit for semi-flush: 25-4097,
 Additional Stems: (6") 25-4066, (12") 25-4067.
 Pendants trestle and Semi-flush include 12' of wire and 4' of chain where applicable.



60-5773



60-5777



60-5776



60-5775

RAINDROP LED

Polished Nickel / White Glass with removable Aquamarine insert



62-141



62-145



62-145
shown without insert

Item#	Description	Finish	Light Source	Watts	Incand. Equiv.	Length	Width	Height	Ext.	CCT	Lumens	CRI	Cert. Type
62-141	Large Pendant	Polished Nickel	LED	25	2x75W	•	25"	10"	•	3000K	2,125*	90	Dry
62-142	Flush	Polished Nickel	LED	25	2x75W	•	15"	4 3/8"	•	3000K	2,125*	90	Damp
62-143	Sconce	Polished Nickel	LED	10	60W	•	7 1/4"	7"	3 1/2"	3000K	850*	90	Damp
62-144	Vanity	Polished Nickel	LED	26	2x60W	•	26 3/4"	7"	3 3/8"	3000K	2,210*	90	Damp
62-145	Semi-flush	Polished Nickel	LED	25	2x75W	•	15"	10 7/8"	•	3000K	2,125*	90	Dry
62-146	Small Pendant	Polished Nickel	LED	25	2x75W	•	15"	4"		3000K	2,125*	90	Dry

*Lumens measured at LED source.
Vanity and Sconce are ADA compliant.

Additional large pendant stems: (6") 25-126, (12") 25-127 Additional small pendant stems: (6") 25-4118, (12") 25-4119
Pendants include 12' of wire. All fixtures include removable aquamarine inserts.



62-146



62-142



62-143



62-144

LAKE

Iron Black with Brushed Nickel Accents



60-5859



60-5857



ST19 Vintage lamps included

Item#	Description	Finish	No. of Lights	Lamp Type	Base	Max Watts	Length	Width	Height	Ext.	Cert. Type
60-5856	Sconce	Iron Black / Br. Nickel	1	A19†	Med.	60W	•	8"	12"	4 ½"	Damp
60-5857	2 Lt. Square Pendant	Iron Black / Br. Nickel	2	A19†	Med.	60W	•	14"	20 ½"	•	Dry
60-5858	4 Lt. Square Pendant	Iron Black / Br. Nickel	4	A19†	Med.	60W	•	19"	27 ¾"	•	Dry
60-5859	Island Pendant	Iron Black / Br. Nickel	4	A19†	Med.	60W	36"	10"	11 ¼"	•	Dry
60-5860	Mini Pendant	Iron Black / Br. Nickel	1	A19†	Med.	60W	•	8 ⅞"	13 ¾"	•	Dry

†60W ST19 S2423 Vintage lamps included.

Additional Stems: (6") 25-5858, (12") 25-5859.
Pendants include 12' of wire.



60-5856



60-5860



60-5858

LAKE

Bronze with Copper Accents



60-5854



60-5852



ST19 Vintage lamps included

Item#	Description	Finish	No. of Lights	Lamp Type	Base	Max Watts	Length	Width	Height	Ext.	Cert. Type
60-5851	Sconce	Bronze / Copper	1	A19†	Med.	60W	•	8"	12"	4 ½"	Damp
60-5852	2 Lt. Square Pendant	Bronze / Copper	2	A19†	Med.	60W	•	14"	20 ½"	•	Dry
60-5853	4 Lt. Square Pendant	Bronze / Copper	4	A19†	Med.	60W	•	19"	27 ¾"	•	Dry
60-5854	Island Pendant	Bronze / Copper	4	A19†	Med.	60W	36"	10"	11 ¼"	•	Dry
60-5855	Mini Pendant	Bronze / Copper	1	A19†	Med.	60W	•	8 ⅛"	13 ¾"	•	Dry

†60W ST19 S2423 Vintage lamps included.

Additional Stems: (6") 25-4171, (12") 25-4172.
Pendants include 12' of wire.



60-5851



60-5855



60-5853

ORIN

Iron Black with Brushed Nickel Accents or
Aged Bronze with Vintage Brass Accents



60-6261



60-6263



60-6262

Item#	Description	Finish	No. of Lights	Lamp Type	Base	Max Watts	Length	Width	Height	Ext.	Cert. Type
60-6261	4 Lt. Pendant	Iron Black	4	B10	Cand.	60W	•	24"	26 3/8"	•	Dry
60-6262	3 Lt. Pendant	Iron Black	3	B10	Cand.	60W	•	18"	19 1/4"	•	Dry
60-6263	1 Lt. Pendant	Iron Black	1	A19	Med.	100W	•	12"	15 3/8"	•	Dry
60-6361	4 Lt. Pendant	Aged Bronze	4	B10	Cand.	60W	•	24"	26 3/8"	•	Dry
60-6362	3 Lt. Pendant	Aged Bronze	3	B10	Cand.	60W	•	18"	19 1/4"	•	Dry
60-6363	1 Lt. Pendant	Aged Bronze	1	A19	Med.	100W	•	12"	15 3/8"	•	Dry

Additional Stems (Iron Black): (6") 25-6261, (12") 25-6262, Additional Stems (Aged Bronze): (6") 25-4066, (12") 25-4067.
Pendants include 12' of wire.





DESIGN WITH AN OPEN MIND.

Three pendants, and so many possibilities – the only consideration would be size – it can't help but work. Antique Gold and Mirror Glass and an open frame design makes the Stanza collection one of those go-to fixture families for almost any venue.

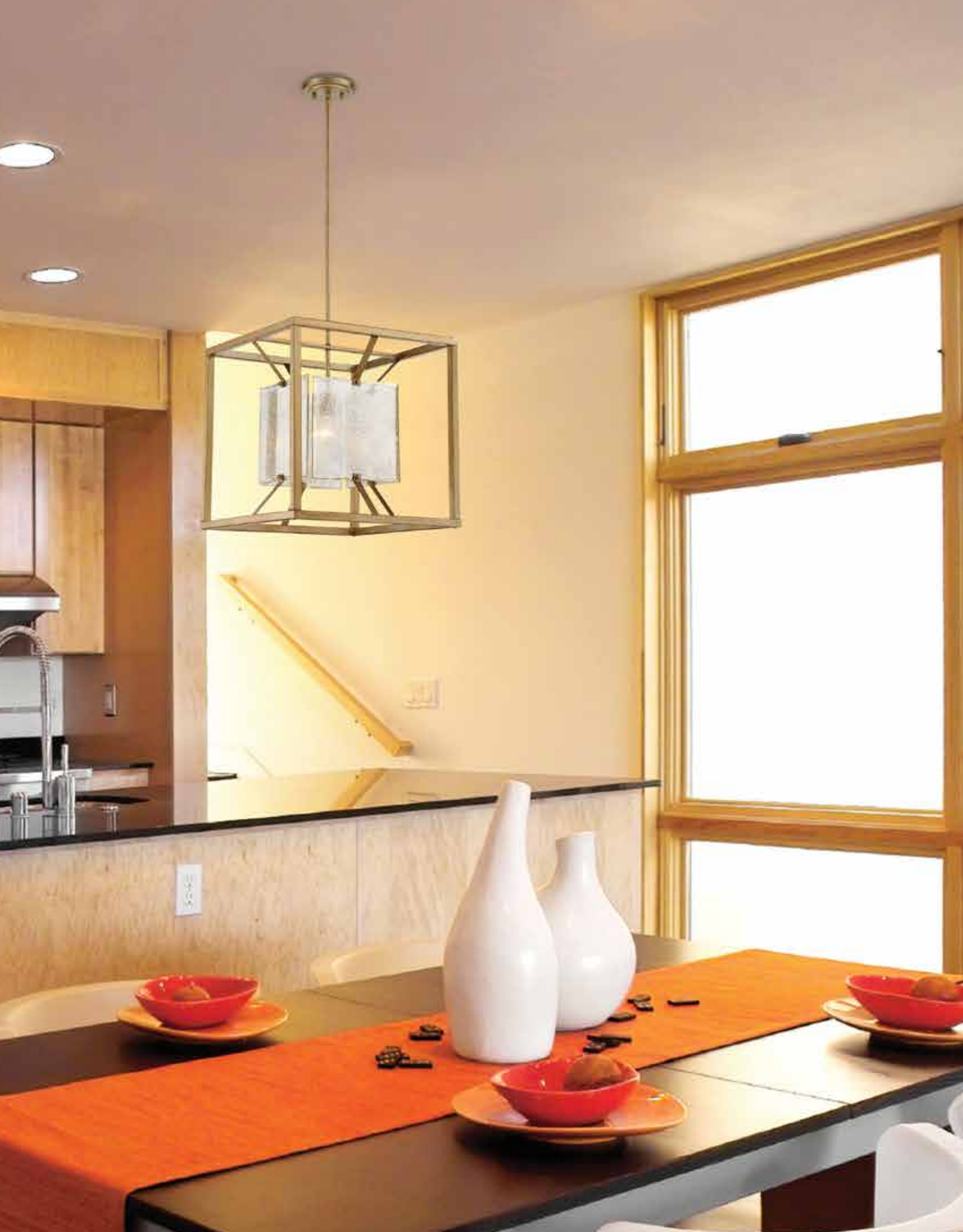

Item#	Description	Finish	No. of Lights	Lamp Type	Base	Max Watts	Length	Width	Height	Ext.	Cert. Type
60-6281	Small Pendant	Forest Bronze	1	A19	Med.	100W	•	17"	22 1/8"	•	Dry
60-6282	Medium Pendant	Forest Bronze	1	A19	Med.	100W	•	14"	17 3/8"	•	Dry
60-6283	Large Pendant	Forest Bronze	1	A19	Med.	100W	•	10"	22 1/8"	•	Dry

†60W ST19 S2423 Vintage lamps included.

Additional Stems: (6") 25-5967, (12") 25-5977.
Pendants include 12' of wire.

MYSTIC

Forest Bronze / Antique Mirror Glass



60-6281



60-6283



60-6282



ST19 Vintage lamps included

Item#	Description	Finish	No. of Lights	Lamp Type	Base	Max Watts	Length	Width	Height	Ext.	Cert. Type
60-6271	Medium Pendant	Antique Gold	1	A19	Med.	60W	•	15"	15"	•	Dry
60-6272	Large Pendant	Antique Gold	1	A19	Med.	60W	•	18"	18"	•	Dry
60-6273	Small Pendant	Antique Gold	1	A19	Med.	60W	•	12"	12"	•	Dry

Additional Stems: (6") 25-6272, (12") 25-6273.
Pendants include 12' of wire.

STANZA

Antique Gold / Antique Mirror Glass



60-6273



60-6271



60-6272

FRANKIE

Aged Bronze / Cream Fabric Shade / White Diffuser



60-6544

Item#	Description	Finish	No. of Lights	Lamp Type	Base	Max Watts	Length	Width	Height	Ext.	Cert. Type
60-6543	3 Lt. Pendant	Aged Bronze	3	A19	Med.	100W	•	15"	16"	•	Dry
60-6544	4 Lt. Pendant	Aged Bronze	4	A19	Med.	100W	•	24"	24 3/8"	•	Dry
60-6545	Semi-flush*	Aged Bronze	3	A19	Med.	100W	•	15"	10 5/8"	•	Dry

Additional chain: (3') 25-5004*, Pendant conversion kit for semi-flush: 25-5013, Additional Stems: (6") 25-5011, (12") 25-5012.
Pendants and semi-flush include 12' of wire.



60-6543



60-6545

MEADOW

Polished Nickel / White Fabric Shade / Frosted Glass Diffuser



60-5881



60-5883

Item#	Description	Finish	No. of Lights	Lamp Type	Base	Max Watts	Length	Width	Height	Ext.	Cert. Type
60-5881	Pendant	Polished Nickel	4	A19	Med.	60W	•	24"	21 ¾"	•	Dry
60-5882	Foyer	Polished Nickel	3	A19	Med.	60W	•	14"	24 ½"	•	Dry
60-5883	Semi-flush*	Polished Nickel	3	A19	Med.	60W	•	16"	11 ⅞"	•	Dry
60-5884	Mini Pendant	Polished Nickel	1	A19	Med.	60W	•	6 ½"	12 ⅝"	•	Dry
60-5885	Foyer	Polished Nickel	4	A19	Med.	60W	•	17"	32"	•	Dry

*Pendant conversion kit for semi-flush: 25-4143, Additional Stems: (6") 25-4118, (12") 25-4119. Pendants and semi-flush include 12' of wire.



60-5885



60-5884



60-5882

MEADOW

Russet Bronze / White Fabric Shade / Frosted Glass Diffuser

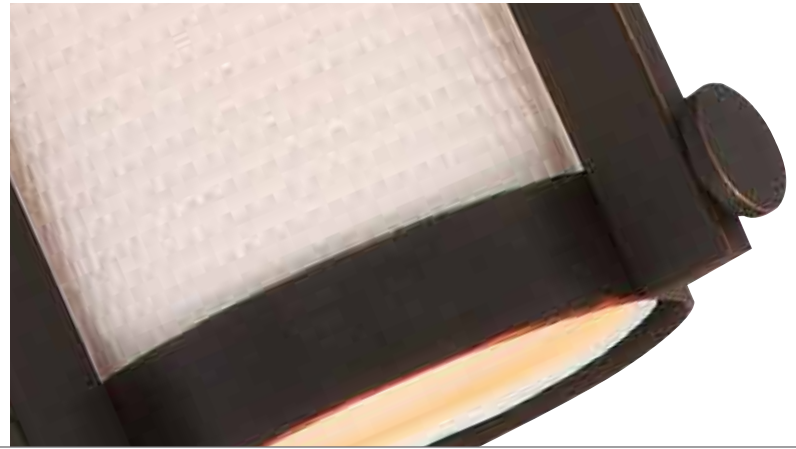

60-5886



60-5888

Item#	Description	Finish	No. of Lights	Lamp Type	Base	Max Watts	Length	Width	Height	Ext.	Cert. Type
60-5886	Pendant	Russet Bronze	4	A19	Med.	60W	•	24"	21 ¾"	•	Dry
60-5887	Foyer	Russet Bronze	3	A19	Med.	60W	•	14"	24 ½"	•	Dry
60-5888	Semi-flush*	Russet Bronze	3	A19	Med.	60W	•	16"	11 ⅞"	•	Dry
60-5889	Mini Pendant	Russet Bronze	1	A19	Med.	60W	•	6 ½"	12 ⅝"	•	Dry
60-5890	Foyer	Russet Bronze	4	A19	Med.	60W	•	17"	32"	•	Dry

*Pendant conversion kit for semi-flush: 25-5888, Additional Stems: (6") 25-5886, (12") 25-5887. Pendants and semi-flush include 12' of wire.



60-5890



60-5889



60-5887

LANSING

Midnight Bronze / White Fabric Shade / Etched Opal Glass



60-6435



60-6433



60-6432

Item#	Description	Finish	No. of Lights	Lamp Type	Base	Max Watts	Length	Width	Height	Ext.	Cert. Type
60-6431	Sconce	Midnight Bronze	2	Type B	Med.	60W	•	8"	12"	3 7/8"	Damp
60-6432	Mini Pendant	Midnight Bronze	1	A19	Med.	60W	•	5 1/4"	12"	•	Dry
60-6433	Foyer	Midnight Bronze	4	A19	Med.	60W	•	14"	26 3/8"	•	Dry
60-6434	Flush	Midnight Bronze	3	A19	Med.	60W	•	16"	5 3/8"	•	Damp
60-6435	Pendant	Midnight Bronze	3	A19	Med.	60W	•	21"	18 3/8"	•	Dry
60-6436	Semi-flush*	Midnight Bronze	3	A19	Med.	60W	•	16"	9 3/8"	•	Dry

Additional chain: (3') 25-6419, *Pendant conversion kit for semi-flush: 25-6418, Additional Stems: (6") 25-6416, (12") 25-6417. Semi-flush, foyer and pendants include 12' of wire.



60-6431



60-6434



60-6436

SENECA

Mahogany Bronze with wrapped rope/
Beige Linen Fabric Shade / Etched Glass Diffuser



60-5896



60-5898

Item#	Description	Finish	No. of Lights	Lamp Type	Base	Max Watts	Length	Width	Height	Ext.	Cert. Type
60-5896	Large Pendant	Mahogany Bronze	4	A19	Med.	60W	•	22"	22 1/8"	•	Dry
60-5897	Small Pendant	Mahogany Bronze	3	Type B	Cand.	60W	•	12"	20 5/8"	•	Dry
60-5898	Mini Pendant	Mahogany Bronze	1	A19	Med.	60W	•	8"	16"	•	Dry
60-5899	Medium Pendant	Mahogany Bronze	3	A19	Med.	60W	•	17"	30 3/8"	•	Dry

Additional Stems: (6") 25-2078, (12") 25-2079.
Pendants include 12' of wire.



60-5899



60-5897

SENECA

Natural Brass / Almond Mesh Fabric Shade / Etched Glass Diffuser

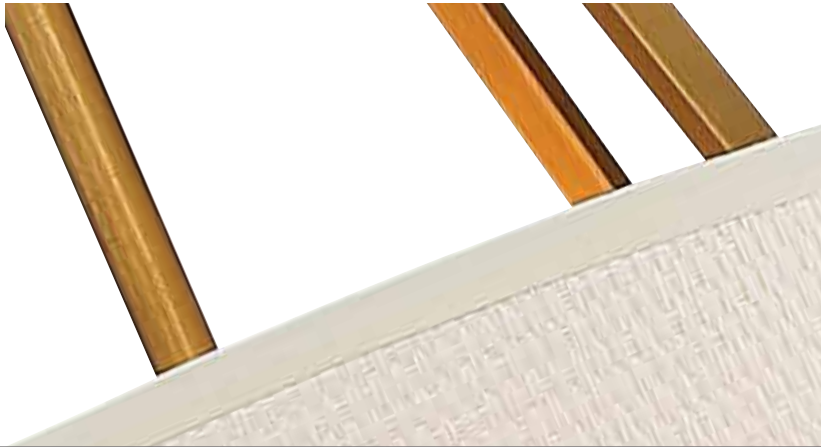

60-5841



60-5843

Item#	Description	Finish	No. of Lights	Lamp Type	Base	Max Watts	Length	Width	Height	Ext.	Cert. Type
60-5841	Large Pendant	Natural Brass	4	A19	Med.	60W	•	22"	22 1/8"	•	Dry
60-5842	Small Pendant	Natural Brass	3	Type B	Cand.	60W	•	12"	20 5/8"	•	Dry
60-5843	Mini Pendant	Natural Brass	1	A19	Med.	60W	•	8"	16"	•	Dry
60-5844	Medium Pendant	Natural Brass	3	A19	Med.	60W	•	17"	30 3/8"	•	Dry

Additional Stems: (6") 25-4151, (12") 25-4152.
Pendants include 12' of wire.



60-5844



60-5842

HARLOW

Polished Nickel / Slate Gray Fabric Shade / Frosted Diffuser

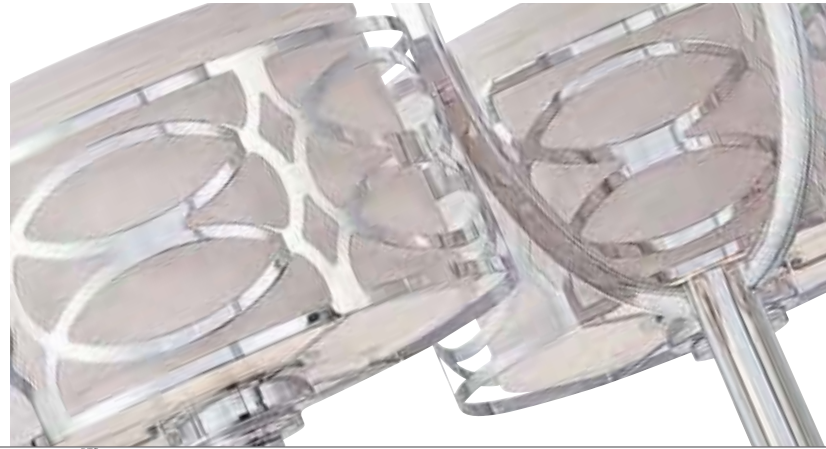

60-4630

Item#	Description	Finish	No. of Lights	Lamp Type	Base	Max Watts	Length	Width	Height	Ext.	Cert. Type
60-4620	3 Lt. Pendant	Polished Nickel	3	A19	Med.	60W	•	17 ¾"	20 ¾"	•	Dry
60-4624	3 Lt. Chandelier	Polished Nickel	3	A19	Med.	60W	•	25"	20 ¾"	•	Dry
60-4626	4 Lt. Pendant	Polished Nickel	4	A19	Med.	60W	•	23 ½"	20"	•	Dry
60-4630	9 Lt. Chandelier	Polished Nickel	9	A19	Med.	60W	•	38"	29 ¼"	•	Dry

Additional chain: (3') 25-4141, Additional chain (for 2 tier chandelier): (3') 25-4142.
 2 Tier chandelier includes 12' of wire and 6' of chain. Other chandelier and pendants include 12' of wire and 4' of chain.



HARLOW

Polished Nickel / Slate Gray Fabric Shade / Frosted Diffuser



60-4625



60-4628

Item#	Description	Finish	No. of Lights	Lamp Type	Base	Max Watts	Length	Width	Height	Ext.	Cert. Type
60-4621	1 Lt. Vanity	Polished Nickel	1	A19	Med.	100W	•	8 7/8"	14 1/8"	10"	Damp
60-4622	2 Lt. Vanity	Polished Nickel	2	A19	Med.	100W	•	20 5/8"	10"	10"	Damp
60-4623	3 Lt. Vanity	Polished Nickel	3	A19	Med.	100W	•	31"	10"	10"	Damp
60-4625	Chandelier	Polished Nickel	5	A19	Med.	60W	•	27 3/4"	20 3/8"	•	Dry
60-4627	Flush	Polished Nickel	2	A19	Med.	60W	•	13 3/8"	6 7/8"	•	Damp
60-4628	Mini Pendant	Polished Nickel	1	A19	Med.	60W	•	8 7/8"	14 3/4"	•	Dry
60-4629	Semi-flush*	Polished Nickel	2	A19	Med.	60W	•	15"	12"	•	Dry

Vanity fixtures CUL listed for glass up or down installation.

Additional chain: (3') 25-4141, *Pendant conversion kit for semi-flush: 25-4143. Chandelier, pendant and semi-flush fixture include 12' of wire and 4' of chain where applicable.



60-4627



60-4629



60-4623



60-4621



60-4622

HARLOW

Hazel Bronze / Khaki Fabric Shade / Cream Diffuser



60-4730

Item#	Description	Finish	No. of Lights	Lamp Type	Base	Max Watts	Length	Width	Height	Ext.	Cert. Type
60-4720	3 Lt. Pendant	Hazel Bronze	3	A19	Med.	60W	•	17 ¾"	20 ¾"	•	Dry
60-4724	3 Lt. Chandelier	Hazel Bronze	3	A19	Med.	60W	•	25"	20 ¾"	•	Dry
60-4726	4 Lt. Pendant	Hazel Bronze	4	A19	Med.	60W	•	23 ⅝"	20"	•	Dry
60-4730	9 Lt. Chandelier	Hazel Bronze	9	A19	Med.	60W	•	38"	29 ¼"	•	Dry

Additional chain: (3') 25-4212, Additional chain (for 2 tier chandelier): (3') 25-4213.
 2 Tier chandelier includes 12' of wire and 6' of chain. Other chandelier and pendants include 12' of wire and 4' of chain.



HARLOW

Hazel Bronze / Khaki Fabric Shade / Cream Diffuser



60-4725



60-4728

Item#	Description	Finish	No. of Lights	Lamp Type	Base	Max Watts	Length	Width	Height	Ext.	Cert. Type
60-4721	1 Lt. Vanity	Hazel Bronze	1	A19	Med.	100W	•	8 7/8"	14 1/8"	10"	Damp
60-4722	2 Lt. Vanity	Hazel Bronze	2	A19	Med.	100W	•	20 5/8"	10"	10"	Damp
60-4723	3 Lt. Vanity	Hazel Bronze	3	A19	Med.	100W	•	31"	10"	10"	Damp
60-4725	Chandelier	Hazel Bronze	5	A19	Med.	60W	•	27 3/4"	20 3/8"	•	Dry
60-4727	Flush	Hazel Bronze	2	A19	Med.	60W	•	13 3/8"	6 7/8"	•	Damp
60-4728	Mini Pendant	Hazel Bronze	1	A19	Med.	60W	•	8 7/8"	14 3/4"	•	Dry
60-4729	Semi-flush*	Hazel Bronze	2	A19	Med.	60W	•	15"	12"	•	Dry

Vanity fixtures CUL listed for glass up or down installation.

Additional chain: (3') 25-4212, *Pendant conversion kit for semi-flush: 25-4214. Chandelier, pendant and semi-flush fixture include 12' of wire and 4' of chain where applicable.



60-4727



60-4729



60-4721



60-4723



60-4722

FILIGREE

Brushed Nickel / White Fabric Shade or Natural Brass / Beige Fabric Shade



60-5964



60-5961



60-5967

Item#	Description	Finish	No. of Lights	Lamp Type	Base	Max Watts	Length	Width	Height	Ext.	Cert. Type
60-5931	Flush/Beige	Natural Brass	2	A19	Med.	60W	•	15"	8"	•	Dry
60-5937	Semi-flush/Beige*	Natural Brass	2	A19	Med.	60W	•	15"	12 1/2"	•	Dry
60-5942	Flush/White	Brushed Nickel	2	A19	Med.	60W	•	14 5/8"	8"	•	Dry
60-5948	Semi-flush/White**	Brushed Nickel	2	A19	Med.	60W	•	14 5/8"	12 1/2"	•	Dry
60-5961	Flush/Beige	Natural Brass	2	A19	Med.	60W	•	15"	8"	•	Dry
60-5964	Pendant/Beige	Natural Brass	3	A19	Med.	60W	•	17 1/2"	7 5/8"	•	Dry
60-5967	Semi-flush/Beige*	Natural Brass	2	A19	Med.	60W	•	15"	12 1/2"	•	Dry

Additional chain (Natural Brass): (3') 25-4153, *Pendant conversion kit for semi-flush (Natural Brass): 25-4161
 Additional chain (Polished Nickel): (3') 25-1069, **Pendant conversion kit for semi-flush (Polished Nickel): 25-1403
 Additional Stems (Natural Brass): (6") 25-4151, (12") 25-4152.
 Semi-flush and pendant include 12' of wire.



60-5942



60-5931



60-5948



60-5937

GEMINI

Brushed Nickel / Slate Gray Fabric Shades / Frosted diffusers



60-4759

Item#	Description	Finish	No. of Lights	Lamp Type	Base	Max Watts	Length	Width	Height	Ext.	Cert. Type
60-4756	Pendant	Brushed Nickel	4	A19	Med.	60W	•	23 1/2"	22 7/8"	•	Dry
60-4758	Semi-Flush*	Brushed Nickel	2	A19	Med.	60W	•	18 3/8"	12 1/4"	•	Dry
60-4759	Chandelier	Brushed Nickel	9	A19	Med.	60W	•	31 1/4"	26 1/2"	•	Dry
60-4761	Flush	Brushed Nickel	2	A19	Med.	60W	•	14 3/4"	7 1/8"	•	Damp

Additional chain: (3') 25-1069, *Pendant conversion kit for semi-flush: 25-1403.
Pendant includes 12' of wire and 4' of chain. Semi-flush includes 12' of wire. Chandelier includes 12' of wire and 6' of chain.



60-4756



60-4761



60-4758

GEMINI

Brushed Nickel / Slate Gray Fabric Shades / Frosted diffusers

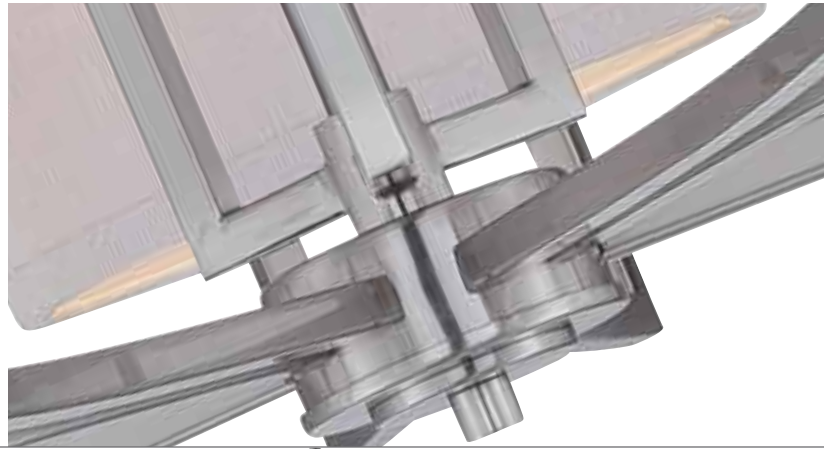

60-4757



60-4755

Item#	Description	Finish	No. of Lights	Lamp Type	Base	Max Watts	Length	Width	Height	Ext.	Cert. Type
60-4751	1 Lt. Vanity	Brushed Nickel	1	A19	Med.	100W	•	8"	10 3/8"	5 5/8"	Damp
60-4752	2 Lt. Vanity	Brushed Nickel	2	A19	Med.	100W	•	18 1/4"	11 1/4"	6"	Damp
60-4753	3 Lt. Vanity	Brushed Nickel	3	A19	Med.	100W	•	27 1/4"	11 1/4"	7 1/2"	Damp
60-4754	Sconce	Brushed Nickel	2	A19	Med.	60W	•	16"	7 1/4"	5 1/2"	Damp
60-4755	5 Lt. Chandelier	Brushed Nickel	5	A19	Med.	60W	•	25"	21 1/4"	•	Dry
60-4757	3 Lt. Chandelier	Brushed Nickel	3	A19	Med.	60W	•	21"	20 3/4"	•	Dry

Additional chain: (3') 25-1069
Chandeliers include 12' of wire and 4' of chain.



60-4751



60-4752



60-4754



60-4753

GEMINI

Hazel Bronze / Khaki Fabric Shades / Cream diffusers



60-4859

Item#	Description	Finish	No. of Lights	Lamp Type	Base	Max Watts	Length	Width	Height	Ext.	Cert. Type
60-4856	Pendant	Hazel Bronze	4	A19	Med.	60W	•	23 1/2"	22 7/8"	•	Dry
60-4858	Semi-Flush*	Hazel Bronze	2	A19	Med.	60W	•	18 3/8"	12 1/4"	•	Dry
60-4859	Chandelier	Hazel Bronze	9	A19	Med.	60W	•	31 1/4"	26 1/2"	•	Dry
60-4861	Flush	Hazel Bronze	2	A19	Med.	60W	•	14 3/4"	7 1/8"	•	Damp

Additional chain: (3') 25-4212, *Pendant conversion kit for semi-flush: 25-4214.
Pendant includes 12' of wire and 4' of chain. Semi-flush includes 12' of wire. Chandelier includes 12' of wire and 6' of chain.



60-4856



60-4861



60-4858

GEMINI

Hazel Bronze / Khaki Fabric Shades / Cream diffusers



60-4857



60-4855

Item#	Description	Finish	No. of Lights	Lamp Type	Base	Max Watts	Length	Width	Height	Ext.	Cert. Type
60-4851	1 Lt. Vanity	Hazel Bronze	1	A19	Med.	100W	•	8"	10 3/8"	5 5/8"	Damp
60-4852	2 Lt. Vanity	Hazel Bronze	2	A19	Med.	100W	•	18 1/4"	11 1/4"	6"	Damp
60-4853	3 Lt. Vanity	Hazel Bronze	3	A19	Med.	100W	•	27 1/4"	11 1/4"	7 1/2"	Damp
60-4854	Sconce	Hazel Bronze	2	A19	Med.	60W	•	16"	7 1/4"	5 1/2"	Damp
60-4855	5 Lt. Chandelier	Hazel Bronze	5	A19	Med.	60W	•	25"	21 1/4"	•	Dry
60-4857	3 Lt. Chandelier	Hazel Bronze	3	A19	Med.	60W	•	21"	20 3/4"	•	Dry

Additional chain: (3') 25-4212
Chandeliers include 12' of wire and 4' of chain.



60-4851



60-4852



60-4854



60-4853

DIESEL

Polished Nickel / Slate Gray Fabric Shade / Frosted Diffuser



60-4443

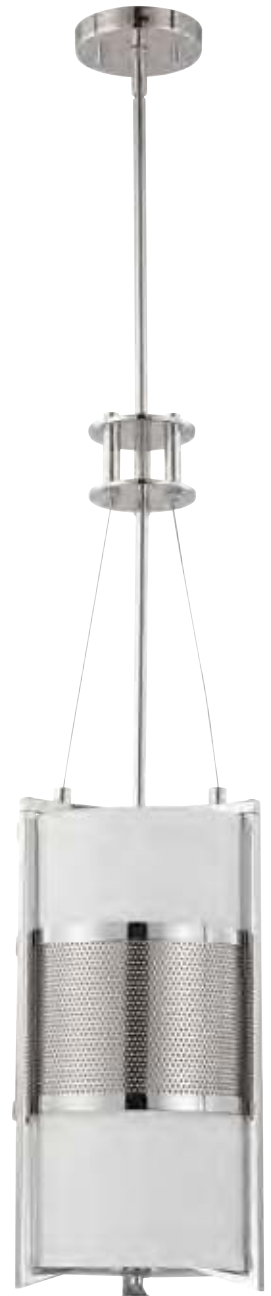

60-4441

Item#	Description	Finish	No. of Lights	Lamp Type	Base	Max Watts	Length	Width	Height	Ext.	Cert. Type
60-4441	Vertical Pendant	Polished Nickel	1	A19	Med.	100W	•	9 ½"	31 ¼"	•	Dry
60-4443	Round Pendant	Polished Nickel	4	A19	Med.	60W	•	21"	27 ⅝"	•	Dry
60-4446	Small Flush	Polished Nickel	3	A19	Med.	60W	•	16"	6 ½"	•	Damp
60-4447	Large Flush	Polished Nickel	4	A19	Med.	60W	•	24"	8 ½"	•	Damp
60-4448	Horizontal Sconce	Polished Nickel	3	A19	Med.	60W	•	22"	7"	5 ½"	Damp
60-4449	Vertical Sconce	Polished Nickel	3	A19	Med.	60W	•	6"	18"	6 ¾"	Damp

Additional Stems: (6") 25-4118, (12") 25-4119.
Pendants include 12' of wire.



60-4446



60-4447



60-4449



60-4448

DIESEL

Hazel Bronze / Khaki Fabric Shade / Cream Diffuser



60-4433



60-4431

Item#	Description	Finish	No. of Lights	Lamp Type	Base	Max Watts	Length	Width	Height	Ext.	Cert. Type
60-4431	Vertical Pendant	Hazel Bronze	1	A19	Med.	100W	•	9 ½"	31 ¼"	•	Dry
60-4433	Round Pendant	Hazel Bronze	4	A19	Med.	60W	•	21"	27 ⅝"	•	Dry
60-4436	Small Flush	Hazel Bronze	3	A19	Med.	60W	•	16"	6 ½"	•	Damp
60-4437	Large Flush	Hazel Bronze	4	A19	Med.	60W	•	24"	8 ½"	•	Damp
60-4438	Horizontal Sconce	Hazel Bronze	3	A19	Med.	60W	•	22"	7"	5 ½"	Damp
60-4439	Vertical Sconce	Hazel Bronze	3	A19	Med.	60W	•	6"	18"	6 ¾"	Damp

Additional Stems: (6") 25-4121, (12") 25-4122.
Pendants include 12' of wire.



60-4436



60-4437



60-4439



60-4438

Item#	Description	Finish	No. of Lights	Lamp Type	Base	Max Watts	Length	Width	Height	Ext.	Cert. Type
60-4464	Sconce	Polished Nickel	2	A19	Med.	60W	•	16 ¾"	8"	6 ⅝"	Damp
60-4468	Small Oval Flush	Polished Nickel	2	A19	Med.	60W	16"	11"	6 ¼"	•	Damp
60-4469	Large Oval Flush	Polished Nickel	6	A19	Med.	60W	24"	16"	7 ¾"	•	Damp

PORTIA

Polished Nickel / Slate Gray Fabric Shade / Frosted Diffuser



60-4469



60-4468



60-4464

Item#	Description	Finish	No. of Lights	Lamp Type	Base	Max Watts	Length	Width	Height	Ext.	Cert. Type
60-4454	Sconce	Hazel Bronze	2	A19	Med.	60W	•	16 ¾"	8"	6 ⅝"	Damp
60-4458	Small Oval Flush	Hazel Bronze	2	A19	Med.	60W	16"	11"	6 ¼"	•	Damp
60-4459	Large Oval Flush	Hazel Bronze	6	A19	Med.	60W	24"	16"	7 ¾"	•	Damp

PORTIA

Hazel Bronze / Khaki Fabric Shade / Cream Diffuser



60-4459



60-4458



60-4454

CANDICE

Brushed Nickel / Pleated White Shades / Frosted diffusers



60-4739

Item#	Description	Finish	No. of Lights	Lamp Type	Base	Max Watts	Length	Width	Height	Ext.	Cert. Type
60-4736	Pendant	Brushed Nickel	3	A19	Med.	60W	•	24"	24 ½"	•	Dry
60-4737	Semi-Flush*	Brushed Nickel	4	A19	Med.	60W	•	15"	12"	•	Dry
60-4739	9 Lt. Chandelier	Brushed Nickel	9	A19	Med.	60W	•	36"	32 ½"	•	Dry
60-4741	Flush	Brushed Nickel	3	A19	Med.	60W	•	15"	7 ½"	•	Damp

Additional chain: (3') 25-1069, Additional chain (for 2 tier chandelier): (3') 25-4052, *Pendant conversion kit for semi-flush: 25-1403.
Pendant includes 12' of wire and 4' of chain. Semi-flush includes 12' of wire. Chandelier includes 12' of wire and 6' of chain.



60-4736



60-4741



60-4737

CANDICE

Brushed Nickel / Pleated White Shades / Frosted diffusers



60-4735



60-4738

Item#	Description	Finish	No. of Lights	Lamp Type	Base	Max Watts	Length	Width	Height	Ext.	Cert. Type
60-4731	1 Lt. Vanity	Brushed Nickel	1	A19	Med.	100W	•	7"	11"	10"	Damp
60-4732	2 Lt. Vanity	Brushed Nickel	2	A19	Med.	100W	•	16"	11 ¼"	10"	Damp
60-4733	3 Lt. Vanity	Brushed Nickel	3	A19	Med.	100W	•	25"	10 ¾"	10"	Damp
60-4734	3 Lt. Chandelier	Brushed Nickel	3	A19	Med.	60W	•	24"	24 ½"	•	Dry
60-4735	5 Lt. Chandelier	Brushed Nickel	5	A19	Med.	60W	•	28"	24 ½"	•	Dry
60-4738	Mini Pendant	Brushed Nickel	1	A19	Med.	60W	•	7"	9 ¼"	•	Dry

Additional chain: (3') 25-1069, Additional Stems: (6") 25-2057, (12") 25-2055
Chandeliers and pendant include 12' of wire and 4' of chain where applicable.



60-4734



60-4731



60-4732



60-4733

PARALLEL

Polished Nickel / Etched Opal Glass



60-5206



60-5207



60-5205

Item#	Description	Finish	No. of Lights	Lamp Type	Base	Max Watts	Length	Width	Height	Ext.	Cert. Type
60-5201	1 Lt. Vanity	Polished Nickel	1	A19	Med.	100W	•	5"	12 1/2"	8 3/4"	Damp
60-5202	2 Lt. Vanity	Polished Nickel	2	A19	Med.	100W	•	13"	7 3/4"	8 3/4"	Damp
60-5203	3 Lt. Vanity	Polished Nickel	3	A19	Med.	100W	•	21"	7 3/4"	8 3/4"	Damp
60-5204	4 Lt. Vanity	Polished Nickel	4	A19	Med.	100W	•	29"	7 3/4"	8 3/4"	Damp
60-5205	5 Lt. Chandelier	Polished Nickel	5	A19	Med.	60W	•	26"	20 1/4"	•	Dry
60-5206	3 Lt. Chandelier	Polished Nickel	3	A19	Med.	60W	•	23"	17 1/4"	•	Dry
60-5207	Flush	Polished Nickel	3	A19	Med.	60W	•	15"	6 1/2"	•	Damp

Vanity fixtures CUL listed for glass up or down installation.

Additional chain: (3') 25-4141
Chandeliers includes 12' of wire and 4' of chain.



60-5203



60-5201



60-5204



60-5202

PARALLEL

Aged Bronze / Etched Opal Glass



60-5306



60-5307



60-5305

Item#	Description	Finish	No. of Lights	Lamp Type	Base	Max Watts	Length	Width	Height	Ext.	Cert. Type
60-5301	1 Lt. Vanity	Aged Bronze	1	A19	Med.	100W	•	5"	12 1/2"	8 3/4"	Damp
60-5302	2 Lt. Vanity	Aged Bronze	2	A19	Med.	100W	•	13"	7 3/4"	8 3/4"	Damp
60-5303	3 Lt. Vanity	Aged Bronze	3	A19	Med.	100W	•	21"	7 3/4"	8 3/4"	Damp
60-5304	4 Lt. Vanity	Aged Bronze	4	A19	Med.	100W	•	29"	7 3/4"	8 3/4"	Damp
60-5305	5 Lt. Chandelier	Aged Bronze	5	A19	Med.	60W	•	26"	20 1/4"	•	Dry
60-5306	3 Lt. Chandelier	Aged Bronze	3	A19	Med.	60W	•	23"	17 1/4"	•	Dry
60-5307	Flush	Aged Bronze	3	A19	Med.	60W	•	15"	6 1/2"	•	Damp

Vanity fixtures CUL listed for glass up or down installation.

Additional chain: (3') 25-4058
Chandeliers includes 12' of wire and 4' of chain.



60-5303



60-5301



60-5304



60-5302





WHEN THE HOME, THE ROOM AND THE LIGHTING COME TOGETHER PERFECTLY.

Classically contemporary in Brushed Nickel with Etched Opal Glass can be at home – or be the focal point – almost anywhere. This is the fixture interior designers know will give a space that final touch it needs.

CELINE

Polished Nickel / Etched Opal Glass



60-5477



60-5476



60-5475



*G9 Halogen lamps included

Item#	Description	Finish	No. of Lights	Lamp Type	Base	Max Watts	Length	Width	Height	Ext.	Cert. Type
60-5471	1 Lt. Vanity	Polished Nickel	1	Halogen	G9*	40W ⁱ	•	5 3/8"	4 3/4"	6 3/8"	Damp
60-5472	2 Lt. Vanity	Polished Nickel	2	Halogen	G9*	40W ⁱ	•	15 3/4"	4 1/2"	6 3/8"	Damp
60-5473	3 Lt. Vanity	Polished Nickel	3	Halogen	G9*	40W ⁱ	•	26"	4 1/2"	10"	Damp
60-5474	4 Lt. Vanity	Polished Nickel	4	Halogen	G9*	40W ⁱ	•	36 1/4"	4 1/2"	10"	Damp
60-5475	Chandelier	Polished Nickel	5	Halogen	G9*	40W ⁱ	•	26 7/8"	20"	•	Dry
60-5476	Flush	Polished Nickel	2	A19	Med.	60W	•	13 5/8"	6 1/8"	•	Damp
60-5477	Semi-flush	Polished Nickel	3	Halogen	G9*	40W ⁱ	•	15"	11 1/4"	•	Dry
60-5478	Mini Pendant	Polished Nickel	1	Halogen	G9*	40W ⁱ	•	7"	9 1/8"	•	Dry

*40w G9 S4641 halogen lamp(s) included.
 Vanity fixtures CUL listed for glass up or down installation.

Additional Stems: (6") 25-4118, (12") 25-4119.
 Chandelier, mini pendant and semi-flush fixtures include 12' of wire.



60-5478



60-5471



60-5472



60-5473



60-5474

CELINE

Venetian Bronze / Etched Opal Glass



60-5577



60-5576



60-5575



*G9 Halogen
lamps included

Item#	Description	Finish	No. of Lights	Lamp Type	Base	Max Watts	Length	Width	Height	Ext.	Cert. Type
60-5571	1 Lt. Vanity	Venetian Bronze	1	Halogen	G9*	40W ⁱ	•	5 3/8"	4 3/4"	6 3/8"	Damp
60-5572	2 Lt. Vanity	Venetian Bronze	2	Halogen	G9*	40W ⁱ	•	15 3/4"	4 1/2"	6 3/8"	Damp
60-5573	3 Lt. Vanity	Venetian Bronze	3	Halogen	G9*	40W ⁱ	•	26"	4 1/2"	10"	Damp
60-5574	4 Lt. Vanity	Venetian Bronze	4	Halogen	G9*	40W ⁱ	•	36 1/4"	4 1/2"	10"	Damp
60-5575	Chandelier	Venetian Bronze	5	Halogen	G9*	40W ⁱ	•	26 7/8"	20"	•	Dry
60-5576	Flush	Venetian Bronze	2	A19	Med.	60W	•	13 5/8"	6 1/8"	•	Damp
60-5577	Semi-flush	Venetian Bronze	3	Halogen	G9*	40W ⁱ	•	15"	11 1/4"	•	Dry
60-5578	Mini Pendant	Venetian Bronze	1	Halogen	G9*	40W ⁱ	•	7"	9 1/8"	•	Dry

*40w G9 S4641 halogen lamp(s) included.

Vanity fixtures CUL listed for glass up or down installation.

Additional Stems: (6") 25-5105, (12") 25-5106.

Chandelier, mini pendant and semi-flush fixtures include 12' of wire.



MOBILI

Brushed Nickel / Satin White Glass



60-5460



60-5458



60-5456



60-5457



60-5450

Item#	Description	Finish	No. of Lights	Lamp Type	Base	Max Watts	Length	Width	Height	Ext.	Cert. Type
60-5450	Semi-flush*	Brushed Nickel	2	A19	Med.	60W	•	13 1/8"	10 1/4"	•	Dry
60-5451	1 Lt. Vanity	Brushed Nickel	1	A19	Med.	100W	•	5 7/8"	8 1/2"	6 7/8"	Damp
60-5452	2 Lt. Vanity	Brushed Nickel	2	A19	Med.	100W	•	15 3/8"	7 7/8"	6 7/8"	Damp
60-5453	3 Lt. Vanity	Brushed Nickel	3	A19	Med.	100W	•	25"	7 7/8"	6 7/8"	Damp
60-5454	4 Lt. Vanity	Brushed Nickel	4	A19	Med.	100W	•	34 5/8"	7 7/8"	6 7/8"	Damp
60-5455	Island Pendant	Brushed Nickel	5	A19	Med.	100W	44 1/8"	5 7/8"	7 5/8"	•	Dry
60-5456	6 Lt. Chandelier	Brushed Nickel	6	A19	Med.	100W	•	28"	14 1/2"	•	Dry
60-5457	Mini Pendant	Brushed Nickel	1	A19	Med.	100W	•	5 7/8"	11 1/8"	•	Dry
60-5458	4 Lt. Chandelier	Brushed Nickel	4	A19	Med.	100W	•	18"	13 5/8"	•	Dry
60-5460	Flush	Brushed Nickel	2	A19	Med.	60W	•	13 1/8"	5 1/8"	•	Damp

Vanity fixtures CUL listed for glass up or down installation.

Additional chain: (3') 25-1069, Additional Stems: (6") 25-2057, (12") 25-2055.
 *Pendant conversion kit for semi-flush: 25-1403 Chandelier, pendants and semi-flush fixtures include 12' of wire.



60-5455



60-5451



60-5454



60-5452



60-5453

MOBILI

Aged Bronze / Satin White Glass



60-5560



60-5558



60-5557



60-5556



60-5550

Item#	Description	Finish	No. of Lights	Lamp Type	Base	Max Watts	Length	Width	Height	Ext.	Cert. Type
60-5550	Semi-flush*	Aged Bronze	2	A19	Med.	60W	•	13 1/8"	10 1/4"	•	Dry
60-5551	1 Lt. Vanity	Aged Bronze	1	A19	Med.	100W	•	5 7/8"	8 1/2"	6 7/8"	Damp
60-5552	2 Lt. Vanity	Aged Bronze	2	A19	Med.	100W	•	15 3/8"	7 7/8"	6 7/8"	Damp
60-5553	3 Lt. Vanity	Aged Bronze	3	A19	Med.	100W	•	25"	7 7/8"	6 7/8"	Damp
60-5554	4 Lt. Vanity	Aged Bronze	4	A19	Med.	100W	•	34 5/8"	7 7/8"	6 7/8"	Damp
60-5555	Island Pendant	Aged Bronze	5	A19	Med.	100W	44 1/8"	5 7/8"	7 5/8"	•	Dry
60-5556	6 Lt. Chandelier	Aged Bronze	6	A19	Med.	100W	•	28"	14 1/2"	•	Dry
60-5557	Mini Pendant	Aged Bronze	1	A19	Med.	100W	•	5 7/8"	11 1/8"	•	Dry
60-5558	4 Lt. Chandelier	Aged Bronze	4	A19	Med.	100W	•	18"	13 5/8"	•	Dry
60-5560	Flush	Aged Bronze	2	A19	Med.	60W	•	13 1/8"	5 1/8"	•	Damp

Vanity fixtures CUL listed for glass up or down installation.

Additional chain: (3') 25-4058, Additional Stems: (6") 25-4066, (12") 25-4067, *Pendant conversion kit for semi-flush: 25-4097. Chandelier, pendants and semi-flush fixtures include 12' of wire.



60-5555



60-5551



60-5554



60-5552



60-5553

TELLER

Polished Chrome / Frosted Etched Glass



60-4269



60-4267

Item#	Description	Finish	No. of Lights	Lamp Type	Base	Max Watts	Length	Width	Height	Ext.	Cert. Type
60-4265	5 Lt. Chandelier	Polished Chrome	5	A19	Med.	60W	•	22"	19 1/2"	•	Dry
60-4266	3 Lt. Chandelier	Polished Chrome	3	A19	Med.	60W	•	20"	18"	•	Dry
60-4267	Mini Pendant	Polished Chrome	1	A19	Med.	100W	•	6"	16"	•	Dry
60-4268	Semi-flush*	Polished Chrome	2	A19	Med.	60W	•	12"	13"	•	Dry
60-4269	9 Lt. Chandelier	Polished Chrome	9	A19	Med.	60W	•	30"	27"	•	Dry

Additional chain: (3') 25-2077, Additional chain (for 2 tier chandelier): (3') 25-4115.

*Pendant conversion kit for semi-flush: 25-1437.

2 Tier chandelier includes 12' of wire and 6' of chain.

Other chandeliers, pendant and semi-flush fixtures include 12' of wire and 4' of chain where applicable.



60-4266



60-4265



60-4268

TELLER

Polished Chrome / Frosted Etched Glass



60-4272



60-4271



60-4273

Item#	Description	Finish	No. of Lights	Lamp Type	Base	Max Watts	Length	Width	Height	Ext.	Cert. Type
60-4261	1 Lt. Vanity	Polished Chrome	1	A19	Med.	100W	•	5 3/8"	9"	6 5/8"	Damp
60-4262	2 Lt. Vanity	Polished Chrome	2	A19	Med.	100W	•	13 1/2"	9"	6 5/8"	Damp
60-4263	3 Lt. Vanity	Polished Chrome	3	A19	Med.	100W	•	21"	9"	6 5/8"	Damp
60-4264	4 Lt. Vanity	Polished Chrome	4	A19	Med.	100W	•	28 1/2"	9"	6 5/8"	Damp
60-4271	Small Flush	Polished Chrome	2	A19	Med.	60W	•	13"	8 1/4"	•	Damp
60-4272	Large Flush	Polished Chrome	3	A19	Med.	60W	•	15"	8 1/2"	•	Damp
60-4273	3 Lt. Dinette	Polished Chrome	3	A19	Med.	60W	•	24 3/4"	21 1/2"	•	Dry
60-5372	1 Lt. Sconce	Polished Chrome	1	A19	Med.	60W	•	12"	6 7/8"	6"	Damp

Vanity fixtures CUL listed for glass up or down installation.

Additional chain: (3') 25-2077.
Dinette includes 12' of wire and 4' of chain.



60-5372



60-4263



60-4261



60-4262



60-4264

SURREY

Brushed Nickel / Frosted Glass



60-4149



60-4148

Item#	Description	Finish	No. of Lights	Lamp Type	Base	Max Watts	Length	Width	Height	Ext.	Cert. Type
60-4145	3 Lt. Chandelier	Brushed Nickel	3	A19	Med.	60W	•	21 3/4"	24"	•	Dry
60-4146	5 Lt. Chandelier	Brushed Nickel	5	A19	Med.	60W	•	24 1/4"	24"	•	Dry
60-4148	Mini Pendant	Brushed Nickel	1	A19	Med.	100W	•	6"	33"	•	Dry
60-4149	9 Lt. Chandelier	Brushed Nickel	9	A19	Med.	60W	•	32"	35"	•	Dry
60-4151	Semi-flush*	Brushed Nickel	2	A19	Med.	60W	•	13"	10"	•	Dry

Additional chain: (3') 25-1069, Additional chain (for 2 tier chandelier): (3') 25-4052.
 Additional Stems: (6") 25-2057, (12") 25-2055, *Pendant conversion kit for semi-flush: 25-1403.
 2 Tier chandelier includes 12' of wire and 6' of chain.
 Other chandeliers, pendant and semi-flush fixtures include 12' of wire and 4' of chain where applicable.



60-4145



60-4146



60-4151

SURREY

Brushed Nickel / Frosted Glass

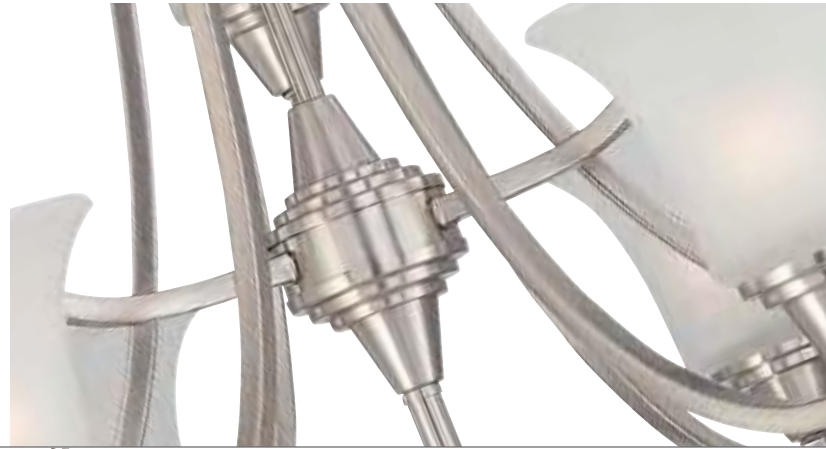

60-4153



60-4147



60-4152

Item#	Description	Finish	No. of Lights	Lamp Type	Base	Max Watts	Length	Width	Height	Ext.	Cert. Type
60-4141	1 Lt. Vanity	Polished Chrome	1	A19	Med.	100W	•	6"	8"	7"	Damp
60-4142	2 Lt. Vanity	Polished Chrome	2	A19	Med.	100W	•	16"	10 1/4"	6 3/4"	Damp
60-4143	3 Lt. Vanity	Polished Chrome	3	A19	Med.	100W	•	23 3/4"	10 1/4"	6 3/4"	Damp
60-4144	4 Lt. Vanity	Polished Chrome	4	A19	Med.	100W	•	30"	10 1/4"	6 3/4"	Damp
60-4147	3 Lt. Pendant	Polished Chrome	3	A19	Med.	60W	•	15 3/4"	21"	•	Dry
60-4152	Small Flush	Polished Chrome	2	A19	Med.	60W	•	13"	7"	•	Damp
60-4153	Large Flush	Polished Chrome	3	A19	Med.	60W	•	15 1/2"	8 3/4"	•	Damp
60-5154	Fixed Track Bar	Polished Chrome	3	Halogen*	GU10	50W	26 3/4"	5 1/2"	12"	•	Dry

*50W MR16/GU10 S3502 halogen lamps included.
Vanity fixtures CUL listed for glass up or down installation.

Additional chain: (3) 25-1069.
Pendant includes 12' of wire and 4' of chain.



60-4141



60-4154*



60-4142



60-4143



60-4144



*MR16 Halogen lamps included

LOREN

Polished Nickel / Etched Opal Glass / White Linen Shade



60-5107



60-5108



60-5104

Item#	Description	Finish	No. of Lights	Lamp Type	Base	Max Watts	Length	Width	Height	Ext.	Cert. Type
60-5101	1 Lt. Vanity	Polished Nickel	1	A19	Med.	100W	•	9 ¼"	6 ¼"	7 ⅞"	Damp
60-5102	2 Lt. Vanity	Polished Nickel	2	A19	Med.	100W	•	18 ¾"	6 ¼"	7 ⅞"	Damp
60-5103	3 Lt. Vanity	Polished Nickel	3	A19	Med.	100W	•	28"	6 ¼"	7 ⅞"	Damp
60-5104	Chandelier	Polished Nickel	4	A19	Med.	60W	•	26 ¼"	18 ¾"	•	Dry
60-5105	Mini Pendant	Polished Nickel	1	A19	Med.	100W	•	8 ½"	9 ¼"	•	Dry
60-5106	Island Pendant	Polished Nickel	3	A19	Med.	60W	36"	6"	17 ⅜"	•	Dry
60-5107	Semi-flush*	Polished Nickel	2	A19	Med.	60W	•	15"	13 ⅞"	•	Dry
60-5108	Pendant	Polished Nickel	4	A19	Med.	60W	•	22"	19 ¾"	•	Dry

Vanity fixtures CUL listed for glass up or down installation.

Additional chain: (3') 25-4141, Additional Stems: (6") 25-4118, (12") 25-4119,

*Pendant conversion kit for semi-flush: 25-4143.
Chandelier, pendants and semi-flush fixtures include 12' of wire and 4' of chain where applicable.



60-5105



60-5106



60-5101



60-5102



60-5103

CONNIE

Polished Nickel / Etched Opal Glass



60-5495



60-5496



60-5499

Item#	Description	Finish	No. of Lights	Lamp Type	Base	Max Watts	Length	Width	Height	Ext.	Cert. Type
60-5491	1 Lt. Vanity	Polished Nickel	1	A19	Med.	100W	•	4 ¾"	9 ½"	6 ⅞"	Damp
60-5492	2 Lt. Vanity	Polished Nickel	2	A19	Med.	100W	•	14 ⅜"	9 ½"	6 ⅞"	Damp
60-5493	3 Lt. Vanity	Polished Nickel	3	A19	Med.	100W	•	24"	9 ½"	6 ⅞"	Damp
60-5494	Pendant	Polished Nickel	3	A19	Med.	100W	•	20"	37 ⅛"	•	Dry
60-5495	5 Lt. Chandelier	Polished Nickel	5	A19	Med.	100W	•	26"	34 ⅝"	•	Dry
60-5496	3 Lt. Chandelier	Polished Nickel	3	A19	Med.	100W	•	18"	29"	•	Dry
60-5497	Semi-flush*	Polished Nickel	2	A19	Med.	60W	•	13"	10 ¾"	•	Dry
60-5498	Mini Pendant	Polished Nickel	1	A19	Med.	100W	•	4 ¾"	8 ⅞"	•	Dry
60-5499	Chandelier	Polished Nickel	9	A19	Med.	100W	•	30"	40 ⅞"	•	Dry

Vanity fixtures CUL listed for glass up or down installation.

Additional chain: (3') 25-4141, Additional chain (for 2 tier chandelier): (3') 25-4142, Additional Stems: (6") 25-4118, (12") 25-4119, *Pendant conversion kit for semi-flush: 25-4143. 2 Tier chandelier includes 12' of wire and 6' of chain. Other chandeliers, pendants and semi-flush fixtures include 12' of wire and 4' of chain where applicable.



60-5498



60-5497



60-5491



60-5494



60-5493



60-5492

SOHO

Polished Chrome / Satin White Glass



60-4586



60-4585

Item#	Description	Finish	No. of Lights	Lamp Type	Base	Max Watts	Length	Width	Height	Ext.	Cert. Type
60-4585	Chandelier	Polished Chrome	5	A19	Med.	60W	•	27 1/2"	20 1/4"	•	Dry
60-4586	Pendant	Polished Chrome	3	A19	Med.	60W	•	16 1/2"	23"	•	Dry
60-4591	Medium Flush	Polished Chrome	2	A19	Med.	60W	•	15 3/8"	8"	•	Damp
60-4592	Large Flush	Polished Chrome	3	A19	Med.	60W	•	18 3/4"	9 1/2"	•	Damp
60-4593	Semi-flush*	Polished Chrome	2	A19	Med.	60W	•	13"	10 1/8"	•	Dry

Additional chain: (3') 25-2077, *Pendant conversion kit for semi-flush: 25-4143.
Chandelier, pendant and semi-flush fixtures include 12' of wire and 4' of chain where applicable.



60-4591



60-4592



60-4593

SOHO

Polished Chrome / Satin White Glass



60-4587



60-4588

Item#	Description	Finish	No. of Lights	Lamp Type	Base	Max Watts	Length	Width	Height	Ext.	Cert. Type
60-4581	1 Lt. Vanity	Polished Chrome	1	A19	Med.	100W	•	7"	8 ¼"	8"	Damp
60-4582	2 Lt. Vanity	Polished Chrome	2	A19	Med.	100W	•	16"	7 ¼"	8"	Damp
60-4583	3 Lt. Vanity	Polished Chrome	3	A19	Med.	100W	•	25"	7 ¼"	8"	Damp
60-4584	4 Lt. Vanity	Polished Chrome	4	A19	Med.	100W	•	34"	7 ¼"	8"	Damp
60-4587	Chandelier	Polished Chrome	3	A19	Med.	60W	•	22"	17 ½"	•	Dry
60-4588	Mini Pendant	Polished Chrome	1	A19	Med.	60W	•	7"	6 ⅞"	•	Dry

Vanity fixtures CUL listed for glass up or down installation.

Additional chain: (3') 25-2077, Additional Stems: (6") 25-2062, (12") 25-2061. Chandelier and pendant include 12' of wire and 4' of chain where applicable.



60-4581



60-4583



60-4582



60-4584

BENTO

Polished Chrome / Satin White Glass



60-4088



60-4085



60-4086



60-4087

Item#	Description	Finish	No. of Lights	Lamp Type	Base	Max Watts	Length	Width	Height	Ext.	Cert. Type
60-4081	1 Lt. Vanity	Polished Chrome	1	A19	Med.	100W	•	5 ¼"	8 ½"	7"	Damp
60-4082	2 Lt. Vanity	Polished Chrome	2	A19	Med.	100W	•	14 ¼"	9 ¼"	7"	Damp
60-4083	3 Lt. Vanity	Polished Chrome	3	A19	Med.	100W	•	22"	9 ¼"	7"	Damp
60-4084	4 Lt. Vanity	Polished Chrome	4	A19	Med.	100W	•	30"	9 ¼"	7"	Damp
60-4085	3 Lt. Chandelier	Polished Chrome	3	A19	Med.	100W	•	20 ¼"	21"	•	Dry
60-4086	5 Lt. Chandelier	Polished Chrome	5	A19	Med.	60W	•	25 ¾"	24 ¾"	•	Dry
60-4087	Semi-flush*	Polished Chrome	2	A19	Med.	60W	•	13"	8 ⅞"	•	Dry
60-4088	Flush	Polished Chrome	2	A19	Med.	60W	•	13"	6 ¼"	•	Damp
60-4091	Island Pendant	Polished Chrome	5	A19	Med.	60W	37 ½"	5 ⅜"	7 ¾"	•	Dry

Vanity fixtures CUL listed for glass up or down installation.

Additional chain: (3') 25-2077, Additional Stems: (6") 25-2062, (12") 25-2061,

*Pendant conversion kit for semi-flush: 25-4143.

Chandeliers, pendant and semi-flush fixtures include 12' of wire and 4' of chain where applicable.



60-4091



60-4081



60-4082



60-4083



60-4084

PARKER

Polished Chrome / Sandstone Etched Glass



60-4006



60-4005



60-5373



60-4007

Item#	Description	Finish	No. of Lights	Lamp Type	Base	Max Watts	Length	Width	Height	Ext.	Cert. Type
60-4001	1 Lt. Vanity	Polished Chrome	1	A19	Med.	100W	•	4 ¾"	9 ½"	6 ¾"	Damp
60-4002	2 Lt. Vanity	Polished Chrome	2	A19	Med.	100W	•	11 ¼"	9 ½"	6 ¾"	Damp
60-4003	3 Lt. Vanity	Polished Chrome	3	A19	Med.	100W	•	18 ¾"	9 ½"	6 ¾"	Damp
60-4004	4 Lt. Vanity	Polished Chrome	4	A19	Med.	100W	•	26"	9 ½"	6 ¾"	Damp
60-4005	Chandelier	Polished Chrome	4	A19	Med.	100W	•	18"	16"	•	Dry
60-4006	Flush	Polished Chrome	2	A19	Med.	60W	15 ¼"	15 ¼"	8 ⅝"	•	Damp
60-4007	Semi-flush*	Polished Chrome	2	A19	Med.	60W	13 ¼"	13 ¼"	11 ¼"	•	Dry
60-4009	Mini Pendant	Polished Chrome	1	A19	Med.	100W	•	4 ¾"	16 ⅝"	•	Dry
60-5373	Sconce	Polished Chrome	1	A19	Med.	60W	•	13"	6 ¾"	6 ½"	Damp

Vanity fixtures CUL listed for glass up or down installation.

Additional chain: (3') 25-2077, *Pendant conversion kit for semi-flush: 25-1437. Chandelier, pendants and semi-flush fixtures include 12' of wire and 4' of chain where applicable.



60-4009



60-4001



60-4002



60-4003



60-4004

HELIUM

Brushed Nickel / Satin White Glass



60-4186



60-4185

Item#	Description	Finish	No. of Lights	Lamp Type	Base	Max Watts	Length	Width	Height	Ext.	Cert. Type
60-4185	3 Lt. Chandelier	Brushed Nickel	3	A19	Med.	60W	•	20"	25 ¼"	•	Dry
60-4186	6 Lt. Chandelier	Brushed Nickel	6	A19	Med.	60W	•	27"	27 ½"	•	Dry
60-4191	Small Flush	Brushed Nickel	1	A19	Med.	60W	•	11 ¼"	6 ½"	•	Damp
60-4192	Medium Flush	Brushed Nickel	2	A19	Med.	60W	•	13"	7"	•	Damp
60-4193	Large Flush	Brushed Nickel	3	A19	Med.	60W	•	15"	7 ½"	•	Damp
60-4194	Mini Pendant	Brushed Nickel	2	A19	Med.	60W	15"	6 ½"	9 ¼"	•	Dry

Additional chain: (3') 25-1069, Additional Stems: (6") 25-2057, (12") 25-2055. Chandeliers and pendants include 12' of wire and 4' of chain where applicable.



HELIUM

Brushed Nickel / Satin White Glass



60-4187



60-4188

Item#	Description	Finish	No. of Lights	Lamp Type	Base	Max Watts	Length	Width	Height	Ext.	Cert. Type
60-4181	1 Lt. Vanity	Brushed Nickel	1	A19	Med.	100W	•	6"	13 1/2"	6 1/2"	Damp
60-4182	2 Lt. Vanity	Brushed Nickel	2	A19	Med.	100W	•	15 1/4"	10"	6 1/2"	Damp
60-4183	3 Lt. Vanity	Brushed Nickel	3	A19	Med.	100W	•	24 1/2"	10 3/4"	6 1/2"	Damp
60-4184	4 Lt. Vanity	Brushed Nickel	4	A19	Med.	100W	•	33 3/4"	11 1/2"	6 1/2"	Damp
60-4187	Pendant	Brushed Nickel	3	A19	Med.	60W	•	17"	24"	•	Dry
60-4188	Semi-flush*	Brushed Nickel	2	A19	Med.	60W	•	13 3/4"	12"	•	Dry

Vanity fixtures CUL listed for glass up or down installation.

Additional chain: (3') 25-1069, *Pendant conversion kit for semi-flush: 25-1403. Pendant includes 12' of wire and 4' of chain, Semi-flush fixture includes 12' of wire.



60-4181



60-4183



60-4182



60-4184

ODEON

Brushed Nickel / Satin White Glass



60-2855
(shown arms up)

Item#	Description	Finish	No. of Lights	Lamp Type	Base	Max Watts	Length	Width	Height	Ext.	Cert. Type
60-2855	9 Lt. Chandelier*	Brushed Nickel	9	A19	Med.	60W	•	30"	27 1/8"	•	Dry
60-2857	Pendant	Brushed Nickel	4	A19	Med.	60W	•	17"	17"	•	Dry
60-2859	Small Flush	Brushed Nickel	2	A19	Med.	60W	•	13 1/8"	4 7/8"	•	Damp
60-2862	Medium Flush	Brushed Nickel	3	A19	Med.	60W	•	15"	5 5/8"	•	Damp
60-2864	Large Flush	Brushed Nickel	3	A19	Med.	60W	•	17"	5 5/8"	•	Damp

Additional chain: (3') 25-1069, Additional chain (for 2 tier chandelier): (3') 25-4052.
Pendant includes 12' of wire and 4' of chain. Chandelier includes 12' of wire and 6' of chain. *Chandeliers are convertible for arm up or down use.



60-2857



60-2859



60-2862



60-2864

ODEON

Brushed Nickel / Satin White Glass



60-2853
(shown arms down)



60-2866

Item#	Description	Finish	No. of Lights	Lamp Type	Base	Max Watts	Length	Width	Height	Ext.	Cert. Type
60-2851	6 Lt. Chandelier*	Brushed Nickel	3	A19	Med.	60W	•	17 ¾"	18 ½"	•	Dry
60-2853	3 Lt. Chandelier*	Brushed Nickel	6	A19	Med.	60W	•	28"	19 ⅞"	•	Dry
60-2866	Mini Pendant	Brushed Nickel	1	A19	Med.	60W	•	5 ⅞"	8 ½"	•	Dry
60-2868	Sconce	Brushed Nickel	1	A19	Med.	100W	•	6"	8"	4 ¼"	Damp
60-2871	2 Lt. Vanity	Brushed Nickel	2	A19	Med.	100W	•	15 ½"	5"	4 ¼"	Damp
60-2873	3 Lt. Vanity	Brushed Nickel	3	A19	Med.	100W	•	23 ⅞"	5"	4 ¼"	Damp
60-2875	4 Lt. Vanity	Brushed Nickel	4	A19	Med.	100W	•	32"	5"	4 ¼"	Damp

Additional chain: (3') 25-1069, Additional Stems: (6") 25-2057, (12") 25-2055.
Chandeliers and pendant include 12' of wire. Chandeliers include 4' of chain. *Chandeliers are convertible for arm up or down use.



60-2851
(shown arms up)



60-2868



60-2871



60-2873



60-2875

ODEON

Aged Bronze / Satin White Glass



60-2979
(shown arms up)

Item#	Description	Finish	No. of Lights	Lamp Type	Base	Max Watts	Length	Width	Height	Ext.	Cert. Type
60-2978	Large Pendant	Aged Bronze	4	A19	Med.	60W	•	17"	17"	•	Dry
60-2979	Chandelier*	Aged Bronze	9	A19	Med.	60W	•	30"	27 1/8"	•	Dry
60-2981	Small Flush	Aged Bronze	2	A19	Med.	60W	•	13 1/8"	4 7/8"	•	Damp
60-2982	Medium Flush	Aged Bronze	3	A19	Med.	60W	•	15"	5 3/8"	•	Damp
60-2983	Large Flush	Aged Bronze	3	A19	Med.	60W	•	17"	5 3/8"	•	Damp

Additional chain: (3') 25-4058, Additional chain (for 2 tier chandelier): (3') 25-4065.
Pendant includes 12' of wire and 4' of chain. Chandelier includes 12' of wire and 6' of chain. *Chandeliers are convertible for arm up or down use.



60-2978



60-2981



60-2982



60-2983

ODEON

Aged Bronze / Satin White Glass



60-2975
(shown arms up)



60-2977

Item#	Description	Finish	No. of Lights	Lamp Type	Base	Max Watts	Length	Width	Height	Ext.	Cert. Type
60-2975	6 Lt. Chandelier*	Aged Bronze	6	A19	Med.	60W	•	28"	19 7/8"	•	Dry
60-2976	3 Lt. Chandelier*	Aged Bronze	3	A19	Med.	60W	•	17 3/4"	18 1/2"	•	Dry
60-2977	Mini Pendant	Aged Bronze	1	A19	Med.	60W	•	5 1/8"	8 1/2"	•	Dry
60-2971	Sconce	Aged Bronze	1	A19	Med.	100W	•	6"	8"	4 1/4"	Damp
60-2972	2 Lt. Vanity	Aged Bronze	2	A19	Med.	100W	•	15 1/2"	5"	4 1/4"	Damp
60-2973	3 Lt. Vanity	Aged Bronze	3	A19	Med.	100W	•	23 7/8"	5"	4 1/4"	Damp
60-2974	4 Lt. Vanity	Aged Bronze	4	A19	Med.	100W	•	32"	5"	4 1/4"	Damp

Additional chain: (3') 25-4058, Additional Stems: (6") 25-4066, (12") 25-4067.
Chandeliers and pendant include 12' of wire. Chandeliers include 4' of chain. *Chandeliers are convertible for arm up or down use.



60-2976
(shown arms down)



60-2971



60-2972



60-2973



60-2974

DECKER

Brushed Nickel / Clear and Frosted Glass



60-4645



60-4647



60-4648

Item#	Description	Finish	No. of Lights	Lamp Type	Base	Max Watts	Length	Width	Height	Ext.	Cert. Type
60-4641	1 Lt. Vanity	Brushed Nickel	1	A19	Med.	60W	•	5 ¾"	10 ¼"	6 ¾"	Damp
60-4642	2 Lt. Vanity	Brushed Nickel	2	A19	Med.	100W	•	13 ¾"	10 ¼"	6 ¾"	Damp
60-4643	3 Lt. Vanity	Brushed Nickel	3	A19	Med.	100W	•	21 ¾"	10 ¼"	6 ¾"	Damp
60-4644	4 Lt. Vanity	Brushed Nickel	4	A19	Med.	100W	•	29 ¾"	10 ¼"	6 ¾"	Damp
60-4645	5 Lt. Chandelier	Brushed Nickel	5	A19	Med.	100W	•	25"	23 ¼"	•	Dry
60-4647	3 Lt. Chandelier	Brushed Nickel	3	A19	Med.	100W	•	25"	23 ¼"	•	Dry
60-4648	Mini Pendant	Brushed Nickel	1	A19	Med.	100W	•	6"	8 ⅝"	•	Dry
60-4651	Medium Flush	Brushed Nickel	2	A19	Med.	100W	•	13"	7"	•	Damp
60-4652	Large Flush	Brushed Nickel	3	A19	Med.	60W	•	15"	6 ⅝"	•	Damp

Additional chain: (3') 25-1069, Additional Stems: (6") 25-2057, (12") 25-2055. Chandeliers and pendant and include 12' of wire and 4' of chain where applicable.



60-4651



60-4641



60-4642



60-4652



60-4643



60-4644

POLARIS

Brushed Nickel / White Opal Glass



60-610



60-608



60-607



60-609

Item#	Description	Finish	No. of Lights	Lamp Type	Base	Max Watts	Length	Width	Height	Ext.	Cert. Type
60-607	Chandelier	Brushed Nickel	6	A19	Med.	60W	•	28 1/2"	30"	•	Dry
60-608	Flush	Brushed Nickel	2	A19	Med.	60W	•	13 1/2"	4 7/8"	•	Damp
60-609	Semi-flush*	Brushed Nickel	2	A19	Med.	60W	•	13 3/4"	8"	•	Dry
60-610	Pendant	Brushed Nickel	3	A19	Med.	60W	•	23"	30 1/4"	•	Dry
60-611	1 Lt. Vanity	Brushed Nickel	1	A19	Med.	100W	•	4 1/2"	8 1/4"	8"	Damp
60-612	2 Lt. Vanity	Brushed Nickel	2	A19	Med.	100W	•	13 1/2"	8 1/4"	8"	Damp
60-613	3 Lt. Vanity	Brushed Nickel	3	A19	Med.	100W	•	21"	8 1/4"	8"	Damp
60-614	4 Lt. Vanity	Brushed Nickel	4	A19	Med.	100W	•	29 3/4"	8 1/4"	8"	Damp
60-615	Mini Pendant	Brushed Nickel	1	A19	Med.	100W	•	5 1/8"	8 7/8"	•	Dry

Vanity fixtures CUL listed for glass up or down installation.

Additional chain: (3') 25-1069, Additional Stems: (6") 25-2057, (12") 25-2055,

*Pendant conversion kit for semi-flush: 25-1431.

Chandelier, pendant and semi-flush fixture include 12' of wire and 4' of chain where applicable.



60-615



60-612



60-611



60-613



60-614

FUSION

Brushed Nickel / Frosted Glass



60-4689

Item#	Description	Finish	No. of Lights	Lamp Type	Base	Max Watts	Length	Width	Height	Ext.	Cert. Type
60-4686	Pendant	Brushed Nickel	3	A19	Med.	60W	•	13 ¾"	19 ¼"	•	Dry
60-4689	Chandelier	Brushed Nickel	9	A19	Med.	60W	•	30 ⅞"	27 ½"	•	Dry
60-4691	Flush	Brushed Nickel	2	A19	Med.	60W	•	15"	6 ⅝"	•	Damp
60-4692	Semi-flush*	Brushed Nickel	2	A19	Med.	60W	•	13 ¾"	12"	•	Dry

Additional chain: (3') 25-1069, Additional chain (for 2 tier chandelier): (3') 25-4052 *Pendant conversion kit for semi-flush: 25-1403. Pendant and semi-flush fixture include 12' of wire and 4' of chain where applicable. Chandelier includes 12' of wire and 6' of chain.



60-4686



60-4691



60-4692

FUSION

Brushed Nickel / Frosted Glass



60-4687



60-4685



60-4688

Item#	Description	Finish	No. of Lights	Lamp Type	Base	Max Watts	Length	Width	Height	Ext.	Cert. Type
60-4681	1 Lt. Vanity	Brushed Nickel	1	A19	Med.	100W	•	5"	7 ¼"	7 ½"	Damp
60-4682	2 Lt. Vanity	Brushed Nickel	2	A19	Med.	100W	•	12"	8 ¼"	7 ½"	Damp
60-4683	3 Lt. Vanity	Brushed Nickel	3	A19	Med.	100W	•	19"	8 ¼"	7 ½"	Damp
60-4684	4 Lt. Vanity	Brushed Nickel	4	A19	Med.	100W	•	27"	8 ¼"	7 ½"	Damp
60-4685	5 Lt. Chandelier	Brushed Nickel	5	A19	Med.	60W	•	22 ¾"	19 ¾"	•	Dry
60-4687	3 Lt. Chandelier	Brushed Nickel	3	A19	Med.	60W	•	17 7/8"	15"	•	Dry
60-4688	Mini Pendant	Brushed Nickel	1	A19	Med.	60W	•	5"	7 ¼"	•	Dry

Vanity fixtures CUL listed for glass up or down installation.

Additional chain: (3') 25-1069, Additional Stems: (6") 25-2057, (12") 25-2055. Chandeliers and pendant include 12' of wire and 4' of chain.



60-4683



60-4681



60-4682



60-4684

GINGER

Brushed Nickel / Etched Opal Glass



60-5331

60-5334

Item#	Description	Finish	No. of Lights	Lamp Type	Base	Max Watts	Length	Width	Height	Ext.	Cert. Type
60-5329	6 Lt. Pendant	Brushed Nickel	6	A19	Med.	100W	•	16"	24 5/8"	•	Dry
60-5331	Semi-flush*	Brushed Nickel	2	A19	Med.	100W	•	14"	8 1/4"	•	Dry
60-5332	Mini Pendant	Brushed Nickel	1	A19	Med.	100W	•	8"	13 7/8"	•	Dry
60-5333	3 Lt. Pendant	Brushed Nickel	3	A19	Med.	100W	•	16"	17"	•	Dry
60-5334	Island Pendant	Brushed Nickel	4	A19	Med.	100W	38"	12"	19 1/8"	•	Dry

Additional chain: (3') 25-1069, Additional chain (for 2 tier chandelier): (3') 25-4052.
 Additional Stems: (6") 25-2057, (12") 25-2055. *Pendant conversion kit for semi-flush: 25-1403.
 Pendants and semi-flush fixture include 12' of wire and 4' of chain where applicable. 2 Tier chandelier includes 12' of wire and 6' of chain.



60-5333



60-5332



60-5329

GINGER

Old Bronze / Etched Opal Glass



60-5335

60-5338

Item#	Description	Finish	No. of Lights	Lamp Type	Base	Max Watts	Length	Width	Height	Ext.	Cert. Type
60-5335	Semi-flush*	Old Bronze	2	A19	Med.	100W	•	14"	24 5/8"	•	Dry
60-5336	Mini Pendant	Old Bronze	1	A19	Med.	100W	•	8"	8 1/4"	•	Dry
60-5337	3 Lt. Pendant	Old Bronze	3	A19	Med.	100W	•	16"	13 7/8"	•	Dry
60-5338	Island Pendant	Old Bronze	4	A19	Med.	100W	38"	12"	17"	•	Dry
60-5339	6 Lt. Pendant	Old Bronze	6	A19	Med.	100W	•	16"	19 1/8"	•	Dry

Additional chain: (3') 25-1067, Additional chain (for 2 tier chandelier): (3') 25-362.
 Additional Stems: (6") 25-2028, (12") 25-2002. *Pendant conversion kit for semi-flush: 25-1402.
 Pendants and semi-flush fixture include 12' of wire and 4' of chain where applicable. 2 Tier chandelier includes 12' of wire and 6' of chain.



60-5337



60-5336



60-5339



SIMPLE IS BEAUTIFUL.

Simplicity is not easy to achieve in design. It's boiling down an object to only its most essential – and beautiful – elements. Crate is a glowing example of this thinking. Right for so many applications, large or small, Crate's understated design is sure to add elegance and interest to any space.



CRATE LED

Brushed Nickel / Gray Marbleized Acrylic Panels



62-893



62-894

Item#	Description	Finish	Light Source	Watts	Incand. Equiv.	Length	Width	Height	Ext.	CCT	Lumens	CRI	Cert. Type
62-891	14" Flush	Brushed Nickel	LED	25	2x100W	•	14"	6"	•	3000K	2,125*	90	Damp
62-892	17" Flush	Brushed Nickel	LED	39	3x75W	•	17"	6"	•	3000K	3,315*	90	Damp
62-893	Pendant	Brushed Nickel	LED	39	3x75W	•	20"	6"	•	3000K	3,315*	90	Dry
62-894	Foyer	Brushed Nickel	LED	25	2x100W	•	14"	22"	•	3000K	2,125*	90	Dry
62-895	12" Vanity	Brushed Nickel	LED	13	75W	•	12"	5"	2 1/2"	3000K	1,105*	90	Damp
62-896	24" Vanity	Brushed Nickel	LED	26	2x75W	•	24"	5"	2 1/2"	3000K	2,380*	90	Damp
62-897	36" Vanity	Brushed Nickel	LED	39	3x75W	•	36"	5"	2 1/2"	3000K	3,315*	90	Damp

*Lumens measured at LED source.
Vanity fixtures are ADA compliant.

Additional Stems: (6") 25-2057, (12") 25-2055



62-892



62-895



62-891



62-896



62-897



IMPACT MADE SIMPLE

Clean, simple design speaks volumes. And even in all its simplicity, Bounce becomes a presence. Polished Nickel and the clear lamps themselves form a simple, almost playful contemporary statement perfect for so many hospitality applications.



BOUNCE

Polished Nickel



60-6566

60-6565

Item#	Description	Finish	No. of Lights	Lamp Type	Base	Max Watts	Length	Width	Height	Ext.	Cert. Type
60-6561	1 Lt. Vanity	Polished Nickel	1	G25	Med.	60W	•	5"	11 3/8"	5 3/4"	Damp
60-6562	2 Lt. Vanity	Polished Nickel	2	G25	Med.	60W	•	13 7/8"	10 5/8"	4 7/8"	Damp
60-6563	3 Lt. Vanity	Polished Nickel	3	G25	Med.	60W	•	24"	10 5/8"	4 7/8"	Damp
60-6564	Flush	Polished Nickel	4	G25	Med.	60W	•	18"	6 3/8"	•	Damp
60-6565	Chandelier	Polished Nickel	5	G25	Med.	60W	•	27"	13 3/8"	•	Dry
60-6566	Mini Pendant	Polished Nickel	1	G25	Med.	60W	•	5"	4 5/8"	•	Dry

Additional Stems: (6") 25-4118, (12") 25-4119.
Chandelier and pendant include 12' of wire.



60-6564



60-6561



60-6563



60-6562

FAWN

Brushed Nickel / Satin White Glass



60-6209



60-6212

Item#	Description	Finish	No. of Lights	Lamp Type	Base	Max Watts	Length	Width	Height	Ext.	Cert. Type
60-6205	5 Lt. Chandelier	Brushed Nickel	5	A19	Med.	100W	•	25"	22"	•	Dry
60-6207	Pendant	Brushed Nickel	2	A19	Med.	100W	•	16"	19 3/4"	•	Dry
60-6209	9 Lt. Chandelier	Brushed Nickel	9	A19	Med.	100W	•	30"	26"	•	Dry
60-6211	Flush	Brushed Nickel	2	A19	Med.	100W	•	14 3/8"	7 5/8"	•	Damp
60-6212	Semi-flush	Brushed Nickel	2	A19	Med.	100W	•	13 1/2"	12 5/8"	•	Dry

Additional chain: (3') 25-1069, *Pendant conversion kit for semi-flush: 25-1403.
 2 tier chandelier includes 12' of wire and 6' of chain, chandelier, pendant and semi-flush include 12' of wire and 4' of chain where applicable.



FAWN

Brushed Nickel / Satin White Glass



60-6208



60-6213

Item#	Description	Finish	No. of Lights	Lamp Type	Base	Max Watts	Length	Width	Height	Ext.	Cert. Type
60-6201	1 Lt. Vanity	Brushed Nickel	1	A19	Med.	100W	•	6"	8 ¾"	8 ¼"	Damp
60-6202	2 Lt. Vanity	Brushed Nickel	2	A19	Med.	100W	•	15"	8 ¾"	8 ¼"	Damp
60-6203	3 Lt. Vanity	Brushed Nickel	3	A19	Med.	100W	•	22"	8 ¾"	8 ¼"	Damp
60-6204	4 Lt. Vanity	Brushed Nickel	4	A19	Med.	100W	•	29 ½"	8 ¾"	8 ¼"	Damp
60-6208	Island Pendant	Brushed Nickel	3	A19	Med.	100W	48 ½"	13 ½"	25"	•	Dry
60-6213	Mini Pendant	Brushed Nickel	1	A19	Med.	100W	•	6"	6 ¾"	•	Dry

Additional chain: (3') 25-1069, Additional Stems: (6") 25-2057, (12") 25-2055.
Pendants include 12' of wire and 4' of chain, where applicable.



60-6204



60-6201



60-6203



60-6202

FAWN

Mahogany Bronze / Satin White Glass



60-6312

60-6309

Item#	Description	Finish	No. of Lights	Lamp Type	Base	Max Watts	Length	Width	Height	Ext.	Cert. Type
60-6305	5 Lt. Chandelier	Mahogany Bronze	5	A19	Med.	100W	•	25"	22"	•	Dry
60-6307	Pendant	Mahogany Bronze	2	A19	Med.	100W	•	16"	19 ¾"	•	Dry
60-6309	9 Lt. Chandelier	Mahogany Bronze	9	A19	Med.	100W	•	30"	26"	•	Dry
60-6311	Flush	Mahogany Bronze	2	A19	Med.	100W	•	14 ¾"	7 ⅝"	•	Damp
60-6312	Semi-flush	Mahogany Bronze	2	A19	Med.	100W	•	13 ½"	12 ⅝"	•	Dry

Additional chain: (3') 25-2081, *Pendant conversion kit for semi-flush: 25-2082.
 2 tier chandelier includes 12' of wire and 6' of chain, chandelier, pendant and semi-flush include 12' of wire and 4' of chain where applicable.



FAWN

Mahogany Bronze / Satin White Glass



Item#	Description	Finish	No. of Lights	Lamp Type	Base	Max Watts	Length	Width	Height	Ext.	Cert. Type
60-6301	1 Lt. Vanity	Mahogany Bronze	1	A19	Med.	100W	•	6"	8 ¾"	8 ¼"	Damp
60-6302	2 Lt. Vanity	Mahogany Bronze	2	A19	Med.	100W	•	15"	8 ¾"	8 ¼"	Damp
60-6303	3 Lt. Vanity	Mahogany Bronze	3	A19	Med.	100W	•	22"	8 ¾"	8 ¼"	Damp
60-6304	4 Lt. Vanity	Mahogany Bronze	4	A19	Med.	100W	•	29 ½"	8 ¾"	8 ¼"	Damp
60-6308	Island Pendant	Mahogany Bronze	3	A19	Med.	100W	48 ½"	13 ½"	25"	•	Dry
60-6313	Mini Pendant	Mahogany Bronze	1	A19	Med.	100W	•	6"	6 ¾"	•	Dry

Additional chain: (3') 25-2081, Additional Stems: (6") 25-2078, (12") 25-2079.
Pendants include 12' of wire and 4' of chain, where applicable.



60-6304



60-6301



60-6303



60-6302

DENVER

Polished Nickel / Satin White Glass



60-6229



60-6227

Item#	Description	Finish	No. of Lights	Lamp Type	Base	Max Watts	Length	Width	Height	Ext.	Cert. Type
60-6225	5 Lt. Chandelier	Polished Nickel	5	A19	Med.	100W	•	22"	17 1/2"	•	Dry
60-6226	3 Lt. Pendant	Polished Nickel	3	A19	Med.	100W	•	11 5/8"	18 3/4"	•	Dry
60-6227	2 Lt. Pendant	Polished Nickel	2	A19	Med.	100W	•	14 3/8"	19 1/2"	•	Dry
60-6229	9 Lt. Chandelier	Polished Nickel	9	A19	Med.	100W	•	31"	28"	•	Dry
60-6231	Flush	Polished Nickel	2	A19	Med.	100W	•	13 5/8"	6 3/8"	•	Damp

Additional chain: (3) 25-4141.
 2 tier chandelier includes 12' of wire and 6' of chain, chandelier and pendant include 12' of wire and 4' of chain.



60-6225



60-6231



60-6226

DENVER

Polished Nickel / Satin White Glass



60-6228

Item#	Description	Finish	No. of Lights	Lamp Type	Base	Max Watts	Length	Width	Height	Ext.	Cert. Type
60-6221	1 Lt. Vanity	Polished Nickel	1	A19	Med.	100W	•	4 5/8"	10 1/8"	6"	Damp
60-6222	2 Lt. Vanity	Polished Nickel	2	A19	Med.	100W	•	14"	10 1/8"	6"	Damp
60-6223	3 Lt. Vanity	Polished Nickel	3	A19	Med.	100W	•	21 1/4"	10 1/8"	6"	Damp
60-6224	4 Lt. Vanity	Polished Nickel	4	A19	Med.	100W	•	29"	10 1/8"	6"	Damp
60-6228	Island Pendant	Polished Nickel	4	A19	Med.	100W	34"	3 5/8"	17 1/2"	•	Dry

Additional chain: (3) 25-4141.
Pendant includes 12' of wire and 4' of chain.



60-6224



60-6221



60-6223



60-6222

DENVER

Mahogany Bronze / Satin White Glass



60-6329



60-6327

Item#	Description	Finish	No. of Lights	Lamp Type	Base	Max Watts	Length	Width	Height	Ext.	Cert. Type
60-6325	5 Lt. Chandelier	Mahogany Bronze	5	A19	Med.	100W	•	22"	17 1/2"	•	Dry
60-6326	3 Lt. Pendant	Mahogany Bronze	3	A19	Med.	100W	•	11 5/8"	18 3/4"	•	Dry
60-6327	2 Lt. Pendant	Mahogany Bronze	2	A19	Med.	100W	•	14 3/8"	19 1/2"	•	Dry
60-6329	9 Lt. Chandelier	Mahogany Bronze	9	A19	Med.	100W	•	31"	28"	•	Dry
60-6331	Flush	Mahogany Bronze	2	A19	Med.	100W	•	13 5/8"	6 3/8"	•	Damp

Additional chain: (3) 25-2081.
 2 tier chandelier includes 12' of wire and 6' of chain, chandelier and pendant include 12' of wire and 4' of chain.



60-6325



60-6331



60-6326

DENVER

Mahogany Bronze / Satin White Glass



60-6328

Item#	Description	Finish	No. of Lights	Lamp Type	Base	Max Watts	Length	Width	Height	Ext.	Cert. Type
60-6321	1 Lt. Vanity	Mahogany Bronze	1	A19	Med.	100W	•	4 5/8"	10 1/8"	6"	Damp
60-6322	2 Lt. Vanity	Mahogany Bronze	2	A19	Med.	100W	•	14"	10 1/8"	6"	Damp
60-6323	3 Lt. Vanity	Mahogany Bronze	3	A19	Med.	100W	•	21 1/4"	10 1/8"	6"	Damp
60-6324	4 Lt. Vanity	Mahogany Bronze	4	A19	Med.	100W	•	29"	10 1/8"	6"	Damp
60-6328	Island Pendant	Mahogany Bronze	4	A19	Med.	100W	34"	3 5/8"	17 1/2"	•	Dry

Additional chain: (3) 25-2081.
Pendant includes 12' of wire and 4' of chain.



60-6324



60-6321



60-6323



60-6322

NOME

Brushed Nickel / Satin White Glass



60-6249



60-6251

Item#	Description	Finish	No. of Lights	Lamp Type	Base	Max Watts	Length	Width	Height	Ext.	Cert. Type
60-6245	Pendant	Brushed Nickel	3	A19	Med.	100W	•	19 1/2"	22"	•	Dry
60-6246	5 Lt. Chandelier	Brushed Nickel	5	A19	Med.	100W	•	24"	23"	•	Dry
60-6249	9 Lt. Chandelier	Brushed Nickel	9	A19	Med.	100W	•	31"	28 1/2"	•	Dry
60-6251	Semi-flush*	Brushed Nickel	2	A19	Med.	100W	•	16 1/4"	14"	•	Dry
60-6252	Flush	Brushed Nickel	2	A19	Med.	100W	•	16 7/8"	7 1/8"	•	Damp

Additional chain: (3') 25-1069, Additional Stems: (6") 25-2057, (12") 25-2055. *Pendant conversion kit for semi-flush: 25-1403. Chandeliers, semi-flush and pendant include 12' of wire.



60-6245



60-6252



60-6246

NOME

Brushed Nickel / Satin White Glass



60-6247



60-6253



60-6248

Item#	Description	Finish	No. of Lights	Lamp Type	Base	Max Watts	Length	Width	Height	Ext.	Cert. Type
60-6241	1 Lt. Vanity	Brushed Nickel	1	A19	Med.	100W	•	4 ¾"	10"	7"	Damp
60-6242	2 Lt. Vanity	Brushed Nickel	2	A19	Med.	100W	•	13 ½"	9 ¼"	7"	Damp
60-6243	3 Lt. Vanity	Brushed Nickel	3	A19	Med.	100W	•	21"	9 ¼"	7"	Damp
60-6244	4 Lt. Vanity	Brushed Nickel	4	A19	Med.	100W	•	29 ½"	9 ¼"	7"	Damp
60-6247	Pendant	Brushed Nickel	2	A19	Med.	100W	•	16 ½"	18"	•	Dry
60-6248	Island Pendant	Brushed Nickel	2	A19	Med.	100W	36 ½"	14 ½"	15"	•	Dry
60-6253	Mini Pendant	Brushed Nickel	1	A19	Med.	100W	•	4 ¾"	7 ⅛"	•	Dry

Additional Stems: (6") 25-2057, (12") 25-2055.
Pendant includes 12' of wire and 4' of chain.



60-6244



60-6243



60-6241



60-6242

NOME

Mahogany Bronze / Satin White Glass



60-6349



60-6351

Item#	Description	Finish	No. of Lights	Lamp Type	Base	Max Watts	Length	Width	Height	Ext.	Cert. Type
60-6345	Pendant	Mahogany Bronze	3	A19	Med.	100W	•	19 1/2"	22"	•	Dry
60-6346	5 Lt. Chandelier	Mahogany Bronze	5	A19	Med.	100W	•	24"	23"	•	Dry
60-6349	9 Lt. Chandelier	Mahogany Bronze	9	A19	Med.	100W	•	31"	28 1/2"	•	Dry
60-6351	Semi-flush*	Mahogany Bronze	2	A19	Med.	100W	•	16 1/8"	14"	•	Dry
60-6352	Flush	Mahogany Bronze	2	A19	Med.	100W	•	16 7/8"	7 1/8"	•	Damp

Additional chain: (3') 25-2081, Additional Stems: (6") 25-2078, (12") 25-2079. *Pendant conversion kit for semi-flush: 25-2082. Chandeliers, semi-flush and pendant include 12' of wire.



60-6345



60-6352



60-6346

NOME

Mahogany Bronze / Satin White Glass



60-6347



60-6353



60-6348

Item#	Description	Finish	No. of Lights	Lamp Type	Base	Max Watts	Length	Width	Height	Ext.	Cert. Type
60-6341	1 Lt. Vanity	Mahogany Bronze	1	A19	Med.	100W	•	4 ¾"	10"	7"	Damp
60-6342	2 Lt. Vanity	Mahogany Bronze	2	A19	Med.	100W	•	13 ½"	9 ¼"	7"	Damp
60-6343	3 Lt. Vanity	Mahogany Bronze	3	A19	Med.	100W	•	21"	9 ¼"	7"	Damp
60-6344	4 Lt. Vanity	Mahogany Bronze	4	A19	Med.	100W	•	29 ½"	9 ¼"	7"	Damp
60-6347	Pendant	Mahogany Bronze	2	A19	Med.	100W	•	16 ½"	18"	•	Dry
60-6348	Island Pendant	Mahogany Bronze	2	A19	Med.	100W	36 ½"	14 ½"	15"	•	Dry
60-6353	Mini Pendant	Mahogany Bronze	1	A19	Med.	100W	•	4 ¾"	7 ⅛"	•	Dry

Additional Stems: (6") 25-2078, (12") 25-2079.
Pendant includes 12' of wire and 4' of chain.



60-6344



60-6343



60-6341



60-6342

CHESTER

Iron Black with Brushed Nickel Accents / White Glass



60-6379

Item#	Description	Finish	No. of Lights	Lamp Type	Base	Max Watts	Length	Width	Height	Ext.	Cert. Type
60-6369	Semi-flush	Iron Black	2	A19	Med.	100W	•	15 ¾"	11 ¾"	•	Dry
60-6375	5 Lt. Chandelier	Iron Black	5	A19	Med.	100W	•	26"	25 ½"	•	Dry
60-6378	Pendant	Iron Black	3	A19	Med.	100W	•	18 ¾"	21 ½"	•	Dry
60-6379	9 Lt. Chandelier	Iron Black	9	A19	Med.	100W	•	32"	29 ½"	•	Dry

Additional chain: (3') **25-6379**, *Pendant conversion kit for semi-flush: **25-6378**.
 2 tier chandelier includes 12' of wire and 6' of chain, chandelier, pendant and semi-flush include 12' of wire and 4' of chain where applicable.



CHESTER

Iron Black with Brushed Nickel Accents / White Glass



60-6376



60-6377

Item#	Description	Finish	No. of Lights	Lamp Type	Base	Max Watts	Length	Width	Height	Ext.	Cert. Type
60-6371	1 Lt. Vanity	Iron Black	1	A19	Med.	100W	•	5 1/8"	7 3/4"	7 1/2"	Damp
60-6372	2 Lt. Vanity	Iron Black	2	A19	Med.	100W	•	14 5/8"	7 3/4"	8 1/4"	Damp
60-6373	3 Lt. Vanity	Iron Black	3	A19	Med.	100W	•	24"	7 3/4"	8 1/4"	Damp
60-6374	4 Lt. Vanity	Iron Black	4	A19	Med.	100W	•	33 1/2"	7 3/4"	8 1/4"	Damp
60-6376	Foyer	Iron Black	2	A19	Med.	100W	•	17"	30 5/8"	•	Dry
60-6377	Mini Pendant	Iron Black	2	A19	Med.	100W	•	5 1/8"	8 1/2"	•	Dry

Additional chain: (3') 25-6379, Additional Stems: (6") 25-6261, (12") 25-6262.
Pendants include 12' of wire and 4' of chain, where applicable.



60-6374



60-6371



60-6373



60-6372

ELIZABETH

Brushed Nickel / Frosted Glass



60-5599

Item#	Description	Finish	No. of Lights	Lamp Type	Base	Max Watts	Length	Width	Height	Ext.	Cert. Type
60-5590	Flush	Brushed Nickel	2	A19	Med.	60W	•	11"	5 1/2"	•	Damp
60-5597	Mini Pendant	Brushed Nickel	1	A19	Med.	60W	•	6"	6 1/2"	•	Dry
60-5599	Chandelier	Brushed Nickel	9	A19	Med.	60W	•	27"	28 1/2"	•	Dry
60-5600	Semi-Flush*	Brushed Nickel	2	A19	Med.	60W	•	13 1/2"	13 3/4"	•	Dry

Additional chain: (3') 25-1069, Additional chain (for 2 tier chandelier): (3') 25-4052,
 *Pendant conversion kit for semi-flush: 25-1403. Additional Stems: (6") 25-2057, (12") 25-2055.
 Pendant includes 12' of wire. Semi-flush includes 12' of wire. Chandelier includes 12' of wire and 6' of chain.



60-5597



60-5590



60-5600

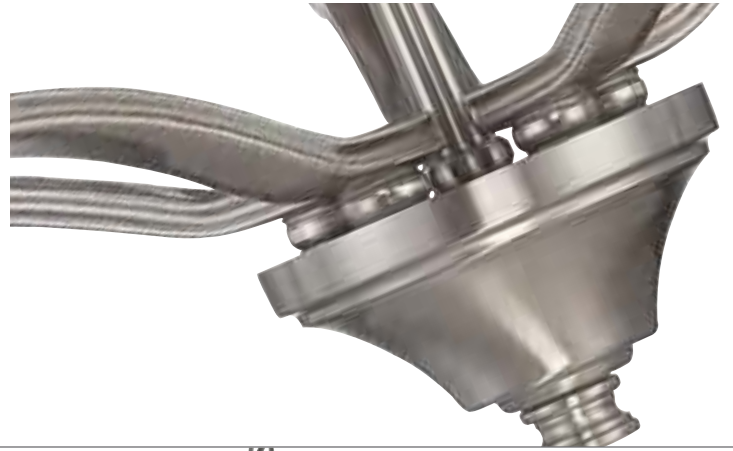

ELIZABETH

Brushed Nickel / Frosted Glass



60-5596



60-5595

Item#	Description	Finish	No. of Lights	Lamp Type	Base	Max Watts	Length	Width	Height	Ext.	Cert. Type
60-5591	1 Lt. Vanity	Brushed Nickel	1	A19	Med.	60W	•	6"	11 1/8"	6 3/8"	Damp
60-5592	2 Lt. Vanity	Brushed Nickel	2	A19	Med.	60W	•	13 3/4"	6 1/2"	7 1/2"	Damp
60-5593	3 Lt. Vanity	Brushed Nickel	3	A19	Med.	60W	•	24"	6 1/2"	7 1/2"	Damp
60-5594	4 Lt. Vanity	Brushed Nickel	4	A19	Med.	60W	•	30"	6 1/2"	7 1/2"	Damp
60-5595	5 Lt. Chandelier	Brushed Nickel	5	A19	Med.	60W	•	25"	24 3/8"	•	Dry
60-5596	3 Lt. Chandelier	Brushed Nickel	3	A19	Med.	60W	•	21 1/2"	22 1/2"	•	Dry

Vanity fixtures CUL listed for glass up or down installation.

Additional chain: (3') 25-1069.
Chandeliers include 12' of wire and 4' of chain.



60-5591



60-5592



60-5593



60-5594

ELIZABETH

Sudbury Bronze / Frosted Glass



60-5699

Item#	Description	Finish	No. of Lights	Lamp Type	Base	Max Watts	Length	Width	Height	Ext.	Cert. Type
60-5690	Flush	Sudbury Bronze	2	A19	Med.	60W	•	11"	5 1/2"	•	Damp
60-5697	Mini Pendant	Sudbury Bronze	1	A19	Med.	60W	•	6"	6 1/2"	•	Dry
60-5699	Chandelier	Sudbury Bronze	9	A19	Med.	60W	•	27"	28 1/2"	•	Dry
60-5700	Semi-Flush*	Sudbury Bronze	2	A19	Med.	60W	•	13 1/2"	13 3/4"	•	Dry

Additional chain: (3') 25-3023, Additional chain (for 2 tier chandelier): (3') 25-4051,
 *Pendant conversion kit for semi-flush: 25-3069. Additional Stems: (6") 25-4085, (12") 25-4086.
 Pendant includes 12' of wire. Semi-flush includes 12' of wire. Chandelier includes 12' of wire and 6' of chain.



60-5697



60-5690



60-5700

ELIZABETH

Sudbury Bronze / Frosted Glass



60-5696



60-5695

Item#	Description	Finish	No. of Lights	Lamp Type	Base	Max Watts	Length	Width	Height	Ext.	Cert. Type
60-5691	1 Lt. Vanity	Sudbury Bronze	1	A19	Med.	60W	•	6"	11 1/8"	6 3/8"	Damp
60-5692	2 Lt. Vanity	Sudbury Bronze	2	A19	Med.	60W	•	13 3/4"	6 1/2"	7 1/2"	Damp
60-5693	3 Lt. Vanity	Sudbury Bronze	3	A19	Med.	60W	•	24"	6 1/2"	7 1/2"	Damp
60-5694	4 Lt. Vanity	Sudbury Bronze	4	A19	Med.	60W	•	30"	6 1/2"	7 1/2"	Damp
60-5695	5 Lt. Chandelier	Sudbury Bronze	5	A19	Med.	60W	•	25"	24 3/8"	•	Dry
60-5696	3 Lt. Chandelier	Sudbury Bronze	3	A19	Med.	60W	•	21 1/2"	22 1/2"	•	Dry

Vanity fixtures CUL listed for glass up or down installation.

Additional chain: (3') 25-3023.
Chandeliers include 12' of wire and 4' of chain.



60-5691



60-5692



60-5693



60-5694

PATTON

Brushed Nickel / Frosted Glass



60-5036



60-5039

Item#	Description	Finish	No. of Lights	Lamp Type	Base	Max Watts	Length	Width	Height	Ext.	Cert. Type
60-5035	5 Lt. Up Chandelier	Brushed Nickel	5	A19	Med.	60W	•	25"	20"	•	Dry
60-5036	3 Lt. Up Chandelier	Brushed Nickel	3	A19	Med.	60W	•	21"	23"	•	Dry
60-5039	9 Lt. Chandelier	Brushed Nickel	9	A19	Med.	60W	•	30"	31"	•	Dry
60-5042	3 Lt. Down Chandelier	Brushed Nickel	3	A19	Med.	60W	•	21"	19"	•	Dry
60-5043	5 Lt. Down Chandelier	Brushed Nickel	5	A19	Med.	60W	•	25"	20"	•	Dry

Additional chain: (3') 25-1069, Additional chain (for 2 tier chandelier): (3') 25-4052.
Chandeliers includes 12' of wire and 4' of chain. 2 tier chandelier includes 12' of wire and 6' of chain.



60-5042



60-5043



60-5035

PATTON

Brushed Nickel / Frosted Glass



60-5038



60-5041



60-5037



60-5044

Item#	Description	Finish	No. of Lights	Lamp Type	Base	Max Watts	Length	Width	Height	Ext.	Cert. Type
60-5031	1 Lt. Vanity	Brushed Nickel	1	A19	Med.	60W	•	5 1/2"	11"	8"	Damp
60-5032	2 Lt. Vanity	Brushed Nickel	2	A19	Med.	60W	•	15"	10"	7"	Damp
60-5033	3 Lt. Vanity	Brushed Nickel	3	A19	Med.	60W	•	21"	10"	7 1/2"	Damp
60-5034	4 Lt. Vanity	Brushed Nickel	4	A19	Med.	60W	•	28"	11"	7 1/2"	Damp
60-5037	Mini Pendant	Brushed Nickel	1	A19	Med.	60W	•	5 1/8"	11 3/8"	•	Dry
60-5038	Pendant	Brushed Nickel	3	A19	Med.	60W	•	16"	21"	•	Dry
60-5041	Flush	Brushed Nickel	3	A19	Med.	60W	•	15 3/4"	7 3/4"	•	Damp
60-5044	Semi-flush*	Brushed Nickel	3	A19	Med.	60W	•	13"	11"	•	Dry

Vanity fixtures CUL listed for glass up or down installation.

Additional chain: (3') 25-1069, *Pendant conversion kit for semi-flush: 25-1403, Additional Stems: (6") 25-2057, (12") 25-2055. Pendant includes 12' of wire. Semi-flush includes 12' of wire.



60-5031



60-5034



60-5032



60-5033

PATTON

Prairie Bronze / Frosted Glass



60-5136



60-5139

Item#	Description	Finish	No. of Lights	Lamp Type	Base	Max Watts	Length	Width	Height	Ext.	Cert. Type
60-5135	5 Lt. Up Chandelier	Prairie Bronze	5	A19	Med.	60W	•	25"	20"	•	Dry
60-5136	3 Lt. Up Chandelier	Prairie Bronze	3	A19	Med.	60W	•	21"	23"	•	Dry
60-5139	9 Lt. Chandelier	Prairie Bronze	9	A19	Med.	60W	•	30"	31"	•	Dry
60-5142	3 Lt. Down Chandelier	Prairie Bronze	3	A19	Med.	60W	•	21"	19"	•	Dry
60-5143	5 Lt. Down Chandelier	Prairie Bronze	5	A19	Med.	60W	•	25"	20"	•	Dry

Additional chain: (3') 25-4206, Additional chain (for 2 tier chandelier): (3') 25-4207.
Chandeliers includes 12' of wire and 4' of chain. 2 tier chandelier includes 12' of wire and 6' of chain.



60-5142



60-5143



60-5135

PATTON

Prairie Bronze / Frosted Glass



60-5138



60-5141



60-5137



60-5144

Item#	Description	Finish	No. of Lights	Lamp Type	Base	Max Watts	Length	Width	Height	Ext.	Cert. Type
60-5131	1 Lt. Vanity	Prairie Bronze	1	A19	Med.	60W	•	5 1/2"	11"	8"	Damp
60-5132	2 Lt. Vanity	Prairie Bronze	2	A19	Med.	60W	•	15"	10"	7"	Damp
60-5133	3 Lt. Vanity	Prairie Bronze	3	A19	Med.	60W	•	21"	10"	7 1/2"	Damp
60-5134	4 Lt. Vanity	Prairie Bronze	4	A19	Med.	60W	•	28"	11"	7 1/2"	Damp
60-5137	Mini Pendant	Prairie Bronze	1	A19	Med.	60W	•	5 1/8"	11 3/8"	•	Dry
60-5138	Pendant	Prairie Bronze	3	A19	Med.	60W	•	16"	21"	•	Dry
60-5141	Flush	Prairie Bronze	3	A19	Med.	60W	•	15 3/4"	7 3/4"	•	Damp
60-5144	Semi-flush*	Prairie Bronze	3	A19	Med.	60W	•	13"	11"	•	Dry

Vanity fixtures CUL listed for glass up or down installation.

Additional chain: (3') 25-4206, *Pendant conversion kit for semi-flush: 25-4211, Additional Stems: (6") 25-4208, (12") 25-4209. Pendant includes 12' of wire. Semi-flush includes 12' of wire.



60-5131



60-5134



60-5132



60-5133

WILLOW

Polished Nickel / White Glass



60-5800



60-5809

Item#	Description	Finish	No. of Lights	Lamp Type	Base	Max Watts	Length	Width	Height	Ext.	Cert. Type
60-5800	4 Lt. Caged Pendant	Polished Nickel	4	Type B	Cand.	60W	•	14"	27 ¾"	•	Dry
60-5805	5 Lt. Chandelier	Polished Nickel	5	A19	Med.	100W	•	27"	21"	•	Dry
60-5809	9 Lt. Chandelier	Polished Nickel	9	A19	Med.	100W	•	32"	27 ½"	•	Dry
60-5872	8 Lt. Caged Pendant	Polished Nickel	8	Type B	Cand.	60W	•	17"	34"	•	Dry

Additional chain: (3') 25-4141, Additional chain (for 2 tier chandelier): (3') 25-4142.
Chandelier and pendants includes 12' of wire and 4' of chain. 2 tier chandelier includes 12' of wire and 6' of chain.



60-5872



60-5805

WILLOW

Polished Nickel / White Glass



60-5807



60-5804



60-5808



60-5806

Item#	Description	Finish	No. of Lights	Lamp Type	Base	Max Watts	Length	Width	Height	Ext.	Cert. Type
60-5801	1 Lt. Vanity	Polished Nickel	1	A19	Med.	100W	•	4 3/8"	8 5/8"	8"	Damp
60-5802	2 Lt. Vanity	Polished Nickel	2	A19	Med.	100W	•	14"	8"	8"	Damp
60-5803	3 Lt. Vanity	Polished Nickel	3	A19	Med.	100W	•	23"	8"	8"	Damp
60-5804	Flush	Polished Nickel	2	A19	Med.	60W	•	13 1/2"	5 1/2"	•	Damp
60-5806	Semi-flush*	Polished Nickel	2	A19	Med.	60W	•	13"	8"	•	Dry
60-5807	Pendant	Polished Nickel	4	A19	Med.	60W	•	18"	17 3/8"	•	Dry
60-5808	Mini Pendant	Polished Nickel	1	A19	Med.	100W	•	3 7/8"	8 5/8"	•	Dry
60-5871	4 Lt. Vanity	Polished Nickel	4	A19	Med.	100W	•	34"	8 1/4"	8"	Damp

Additional chain: (3') 25-4141, *Pendant conversion kit for semi-flush: 25-4143. Additional Stems: (6") 25-4118, (12") 25-4119. Pendants and semi-flush include 12' of wire and 4' of chain, where applicable.



60-5871



60-5801



60-5803



60-5802

WILLOW

Forest Bronze / White Glass



60-5900



60-5909

Item#	Description	Finish	No. of Lights	Lamp Type	Base	Max Watts	Length	Width	Height	Ext.	Cert. Type
60-5900	4 Lt. Caged Pendant	Forest Bronze	4	Type B	Cand.	60W	•	14"	27 ¾"	•	Dry
60-5905	5 Lt. Chandelier	Forest Bronze	5	A19	Med.	100W	•	27"	21"	•	Dry
60-5909	9 Lt. Chandelier	Forest Bronze	9	A19	Med.	100W	•	32"	27 ⅛"	•	Dry
60-5972	8 Lt. Caged Pendant	Forest Bronze	8	Type B	Cand.	60W	•	17"	34"	•	Dry

Additional chain: (3) 25-5924.
Chandelier and pendants include 12' of wire and 4' of chain. 2 tier chandelier includes 12' of wire and 6' of chain.



60-5972



60-5905

WILLOW

Forest Bronze / White Glass



60-5907



60-5904



60-5908



60-5906

Item#	Description	Finish	No. of Lights	Lamp Type	Base	Max Watts	Length	Width	Height	Ext.	Cert. Type
60-5901	1 Lt. Vanity	Forest Bronze	1	A19	Med.	100W	•	4 3/8"	8 5/8"	8"	Damp
60-5902	2 Lt. Vanity	Forest Bronze	2	A19	Med.	100W	•	14"	8"	8"	Damp
60-5903	3 Lt. Vanity	Forest Bronze	3	A19	Med.	100W	•	23"	8"	8"	Damp
60-5904	Flush	Forest Bronze	2	A19	Med.	60W	•	13 1/2"	5 1/2"	•	Damp
60-5906	Semi-flush*	Forest Bronze	2	A19	Med.	60W	•	13"	8"	•	Dry
60-5907	Pendant	Forest Bronze	4	A19	Med.	60W	•	18"	17 3/8"	•	Dry
60-5908	Mini Pendant	Forest Bronze	1	A19	Med.	100W	•	3 7/8"	8 5/8"	•	Dry
60-5971	4 Lt. Vanity	Forest Bronze	4	A19	Med.	100W	•	34"	8 1/4"	8"	Damp

Additional chain: (3') 25-5924, *Pendant conversion kit for semi-flush: 25-5926. Additional Stems: (6") 25-5976, (12") 25-5977. Pendants and semi-flush include 12' of wire and 4' of chain, where applicable.



60-5971



60-5901



60-5903



60-5902

LAGUNA

Brushed Nickel / White Glass



60-5825



60-5829

Item#	Description	Finish	No. of Lights	Lamp Type	Base	Max Watts	Length	Width	Height	Ext.	Cert. Type
60-5825	5 Lt. Chandelier	Brushed Nickel	5	A19	Med.	100W	•	23"	17 1/8"	•	Dry
60-5829	9 Lt. Chandelier	Brushed Nickel	9	A19	Med.	100W	•	31"	27 3/4"	•	Dry
60-5875	Island Pendant	Brushed Nickel	4	A19	Med.	60W	33"	5 1/8"	8 5/8"	•	Dry
60-5876	4 Lt. Caged Pendant	Brushed Nickel	4	Type B	Cand.	60W	•	14"	22 3/4"	•	Dry
60-5877	8 Lt. Caged Pendant	Brushed Nickel	8	Type B	Cand.	60W	•	17"	32 3/4"	•	Dry

Additional chain: (3') 25-1069, Additional chain (for 2 tier chandelier): (3') 25-4052, Additional Stems: (6") 25-2057, (12") 25-2055. Chandeliers and pendant include 12' of wire and 4' of chain. 2 tier chandelier includes 12' of wire and 6' of chain.



60-5876



60-5877



60-5875

LAGUNA

Brushed Nickel / White Glass



60-5827



60-5824



60-5828



60-5826

Item#	Description	Finish	No. of Lights	Lamp Type	Base	Max Watts	Length	Width	Height	Ext.	Cert. Type
60-5821	1 Lt. Vanity	Brushed Nickel	1	A19	Med.	100W	•	5 1/8"	8 1/2"	7 3/8"	Damp
60-5822	2 Lt. Vanity	Brushed Nickel	2	A19	Med.	100W	•	16"	9"	6 1/2"	Damp
60-5823	3 Lt. Vanity	Brushed Nickel	3	A19	Med.	100W	•	24"	9"	6 1/2"	Damp
60-5824	Flush	Brushed Nickel	3	A19	Med.	60W	•	15 1/4"	6 3/4"	•	Damp
60-5826	Semi-flush*	Brushed Nickel	2	A19	Med.	60W	•	15 1/4"	10 3/8"	•	Dry
60-5827	Pendant	Brushed Nickel	4	A19	Med.	60W	•	19 1/2"	22 3/8"	•	Dry
60-5828	Mini Pendant	Brushed Nickel	1	A19	Med.	100W	•	5 1/8"	7 7/8"	•	Dry
60-5874	4 Lt. Vanity	Brushed Nickel	4	A19	Med.	100W	•	33"	9"	6 1/2"	Damp

Additional chain: (3') 25-1069. *Pendant conversion kit for semi-flush: 25-2782, Additional Stems: (6") 25-2057, (12") 25-2058. Pendants and semi-flush include 12' of wire and 4' of chain, where applicable.



60-5874



60-5821



60-5823



60-5822

LAGUNA

Forest Bronze/ White Glass



60-5925



60-5929

Item#	Description	Finish	No. of Lights	Lamp Type	Base	Max Watts	Length	Width	Height	Ext.	Cert. Type
60-5925	5 Lt. Chandelier	Forest Bronze	5	A19	Med.	100W	•	23"	17 1/8"	•	Dry
60-5929	9 Lt. Chandelier	Forest Bronze	9	A19	Med.	100W	•	31"	27 3/4"	•	Dry
60-5975	Island Pendant	Forest Bronze	4	A19	Med.	60W	33"	5 1/8"	8 5/8"	•	Dry
60-5976	4 Lt. Caged Pendant	Forest Bronze	4	Type B	Cand.	60W	•	14"	22 3/4"	•	Dry
60-5977	8 Lt. Caged Pendant	Forest Bronze	8	Type B	Cand.	60W	•	17"	32 3/4"	•	Dry

Additional chain: (3') 25-5924, Additional chain (for 2 tier chandelier): (3') 25-5926, Additional Stems: (6") 25-5976, (12") 25-5977. Chandeliers and pendant include 12' of wire and 4' of chain. 2 tier chandelier includes 12' of wire and 6' of chain.



60-5976



60-5977



60-5975

LAGUNA

Forest Bronze/ White Glass



60-5927



60-5924



60-5928



60-5926

Item#	Description	Finish	No. of Lights	Lamp Type	Base	Max Watts	Length	Width	Height	Ext.	Cert. Type
60-5921	1 Lt. Vanity	Forest Bronze	1	A19	Med.	100W	•	5 1/8"	8 1/2"	7 3/8"	Damp
60-5922	2 Lt. Vanity	Forest Bronze	2	A19	Med.	100W	•	16"	9"	6 1/2"	Damp
60-5923	3 Lt. Vanity	Forest Bronze	3	A19	Med.	100W	•	24"	9"	6 1/2"	Damp
60-5924	Flush	Forest Bronze	3	A19	Med.	60W	•	15 1/4"	6 3/4"	•	Damp
60-5926	Semi-flush*	Forest Bronze	2	A19	Med.	60W	•	15 1/4"	10 3/8"	•	Dry
60-5927	Pendant	Forest Bronze	4	A19	Med.	60W	•	19 1/2"	22 3/8"	•	Dry
60-5928	Mini Pendant	Forest Bronze	1	A19	Med.	100W	•	5 1/8"	7 7/8"	•	Dry
60-5974	4 Lt. Vanity	Forest Bronze	4	A19	Med.	100W	•	33"	9"	6 1/2"	Damp

Additional chain: (3') 25-5924. *Pendant conversion kit for semi-flush: 25-5926, Additional Stems: (6") 25-5976, (12") 25-5977. Pendants and semi-flush include 12' of wire and 4' of chain, where applicable.



60-5974



60-5921



60-5923



60-5922

CASTILLO

Sonoma Bronze / Champagne Glass

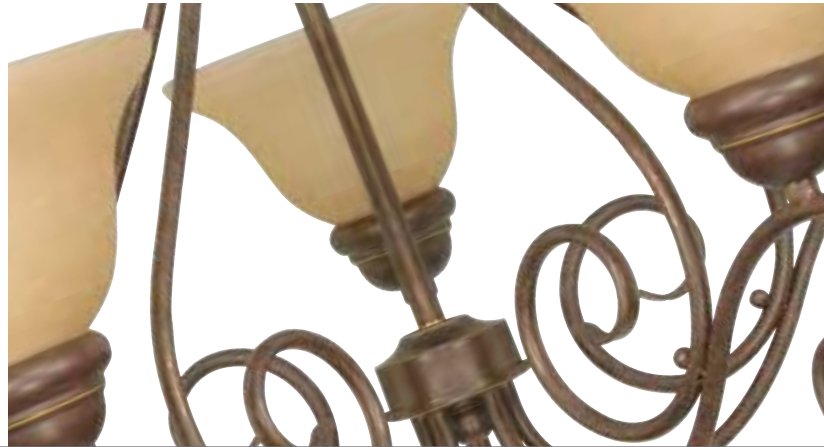

60-1023



60-1021



60-1029

Item#	Description	Finish	No. of Lights	Lamp Type	Base	Max Watts	Length	Width	Height	Ext.	Cert. Type
60-1021	3 Lt. Chandelier	Sonoma Bronze	3	A19	Med.	60W	•	26"	20"	•	Dry
60-1023	5 Lt. Up Chandelier	Sonoma Bronze	5	A19	Med.	60W	•	28"	21"	•	Dry
60-1024	5 Lt. Down Chandelier	Sonoma Bronze	5	A19	Med.	60W	•	28"	21"	•	Dry
60-1025	Trestle	Sonoma Bronze	3	A19	Med.	60W	44"	11 ¾"	21"	•	Dry
60-1028	Pendant	Sonoma Bronze	3	A19	Med.	60W	•	20 ½"	28 ½"	•	Dry
60-1029	Mini Pendant	Sonoma Bronze	1	A19	Med.	100W	•	7 ¼"	5 ⅜"	•	Dry

Additional chain: (3') 25-2075, Additional Stems: (6") 25-2043, (12") 25-2016, Chandeliers and pendants include 12' of wire and 4' of chain where applicable.



60-1024



60-1028



60-1025

CASTILLO

Sonoma Bronze / Champagne Glass



60-1027



60-1037



60-1038



60-1026

Item#	Description	Finish	No. of Lights	Lamp Type	Base	Max Watts	Length	Width	Height	Ext.	Cert. Type
60-1026	Large Flush	Sonoma Bronze	2	A19	Med.	60W	•	15 ¼"	8"	•	Damp
60-1027	Semi-flush*	Sonoma Bronze	3	A19	Med.	60W	•	18 ½"	15 ½"	•	Dry
60-1031	2 Lt. Vanity	Sonoma Bronze	2	A19	Med.	60W	•	17 ¼"	9"	10"	Damp
60-1032	1 Lt. Vanity	Sonoma Bronze	1	A19	Med.	60W	•	7 ¼"	9"	10"	Damp
60-1035	3 Lt. Vanity	Sonoma Bronze	3	A19	Med.	60W	•	25 ½"	9"	10 ¼"	Damp
60-1036	4 Lt. Vanity	Sonoma Bronze	4	A19	Med.	60W	•	33 ½"	9"	10 ¼"	Damp
60-1037	Small Flush	Sonoma Bronze	2	A19	Med.	60W	•	11 ¼"	7"	•	Damp
60-1038	Medium Flush	Sonoma Bronze	2	A19	Med.	60W	•	13 ¼"	7 ½"	•	Damp

Additional chain: (3') 25-2075, *Pendant conversion kit for semi-flush: 25-1418.
Semi-flush includes 12' of wire.



60-1032



60-1036



60-1031



60-1035

CASTILLO

Textured Flat Black / Alabaster Glass



60-380



60-386

60-378

Item#	Description	Finish	No. of Lights	Lamp Type	Base	Max Watts	Length	Width	Height	Ext.	Cert. Type
60-378	3 Lt. Chandelier	Textured Flat Black	3	A19	Med.	60W	•	26"	20"	•	Dry
60-380	5 Lt. Up Chandelier	Textured Flat Black	5	A19	Med.	60W	•	28"	21"	•	Dry
60-381	5 Lt. Down Chandelier	Textured Flat Black	5	A19	Med.	60W	•	28"	21"	•	Dry
60-385	Pendant	Textured Flat Black	3	A19	Med.	60W	•	20 ½"	28 ½"	•	Dry
60-386	Mini Pendant	Textured Flat Black	1	A19	Med.	100W	•	7 ¼"	5 ⅜"	•	Dry

Additional chain: (3') 25-1071, Additional Stems: (6") 25-2052, (12") 25-20256, Chandeliers and pendants include 12' of wire and 4' of chain where applicable.



60-385



60-381

CASTILLO

Textured Flat Black / Alabaster Glass



60-382

Item#	Description	Finish	No. of Lights	Lamp Type	Base	Max Watts	Length	Width	Height	Ext.	Cert. Type
60-382	Trestle	Textured Flat Black	3	A19	Med.	60W	44"	11 3/4"	21"	•	Dry
60-383	Large Flush	Textured Flat Black	2	A19	Med.	60W	•	15 1/4"	8"	•	Damp
60-384	Semi-flush*	Textured Flat Black	3	A19	Med.	60W	•	18 1/2"	15 1/2"	•	Dry
60-387	1 Lt. Vanity	Textured Flat Black	1	A19	Med.	60W	•	7 1/4"	9"	10"	Damp
60-388	2 Lt. Vanity	Textured Flat Black	2	A19	Med.	60W	•	17 1/4"	9"	10"	Damp

Vanity fixtures CUL listed for glass up or down installation.

Additional chain: (3') 25-1071, *Pendant conversion kit for semi-flush: 25-1417. Semi-flush includes 12' of wire.



60-388



60-383



60-387



60-384

BRIDGEVIEW

Mission Dust Bronze Finish



60-1702



60-1701



60-1708

Item#	Description	Finish	No. of Lights	Lamp Type	Base	Max Watts	Length	Width	Height	Ext.	Cert. Type
60-1701	3 Lt. Chandelier	Mission Dust Bronze	3	A19	Med.	60W	•	26 ½"	22"	•	Dry
60-1702	5 Lt. Chandelier	Mission Dust Bronze	5	A19	Med.	60W	•	30"	27"	•	Dry
60-1703	Trestle	Mission Dust Bronze	2	A19	Med.	150W	40"	16"	28"	•	Dry
60-1707	Pendant	Mission Dust Bronze	1	A19	Med.	150W	•	16"	15"	•	Dry
60-1708	Mini Pendant	Mission Dust Bronze	1	A19	Med.	100W	•	8 ½"	6 ½"	•	Dry
60-1709	Sconce	Mission Dust Bronze	1	A19	Med.	100W	•	8 ½"	7 ¼"	10"	Damp
60-1711	Vanity	Mission Dust Bronze	2	A19	Med.	100W	•	20"	7 ¼"	10"	Damp

Additional chain: (3') 25-3021, Additional Stems: (6") 25-4001, (12") 25-4002.
Chandeliers, pendants and Trestle include 12' of wire and 4' of chain where applicable.



60-1711



60-1709



60-1703



60-1707

Eclectic
Ensembles

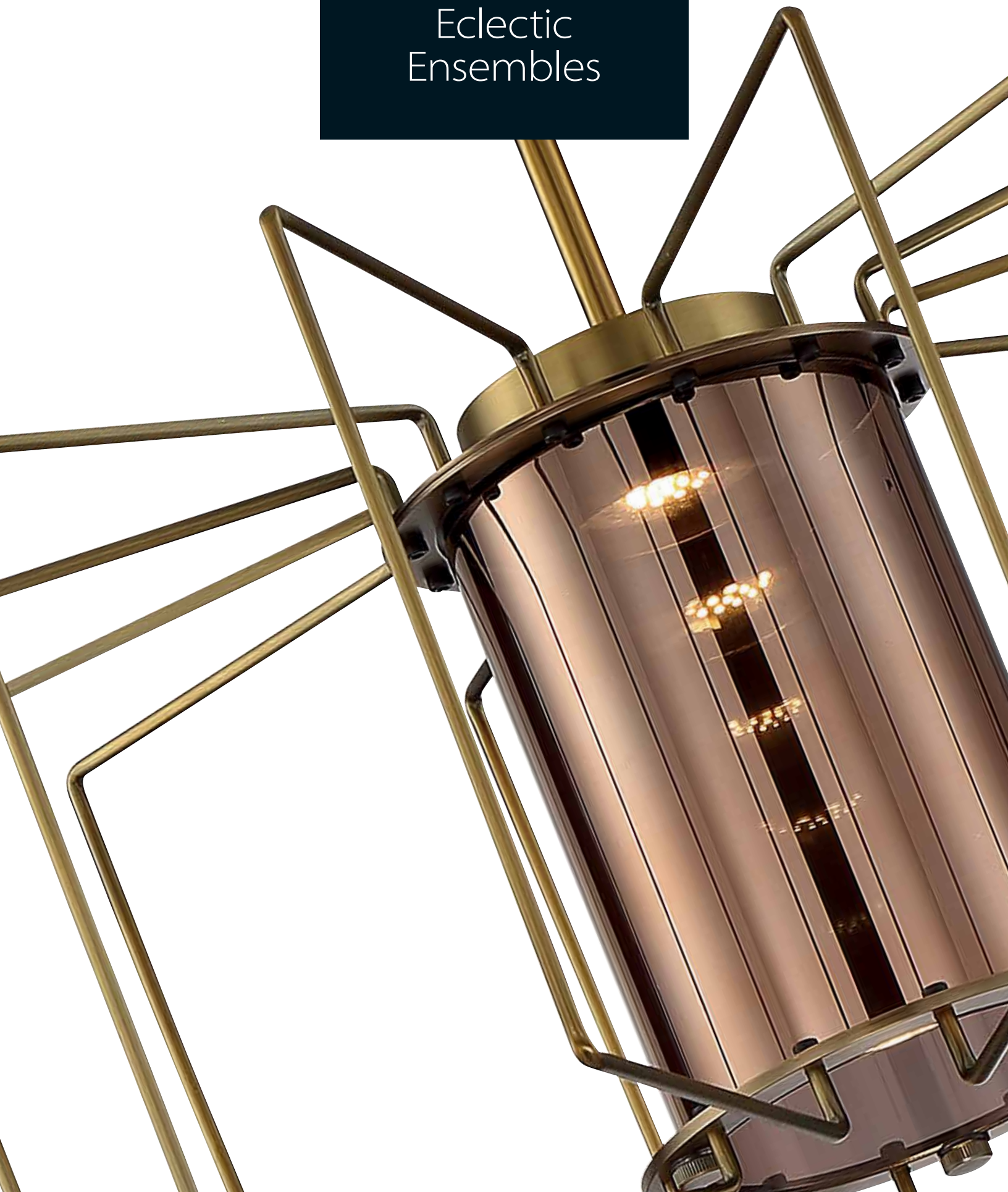

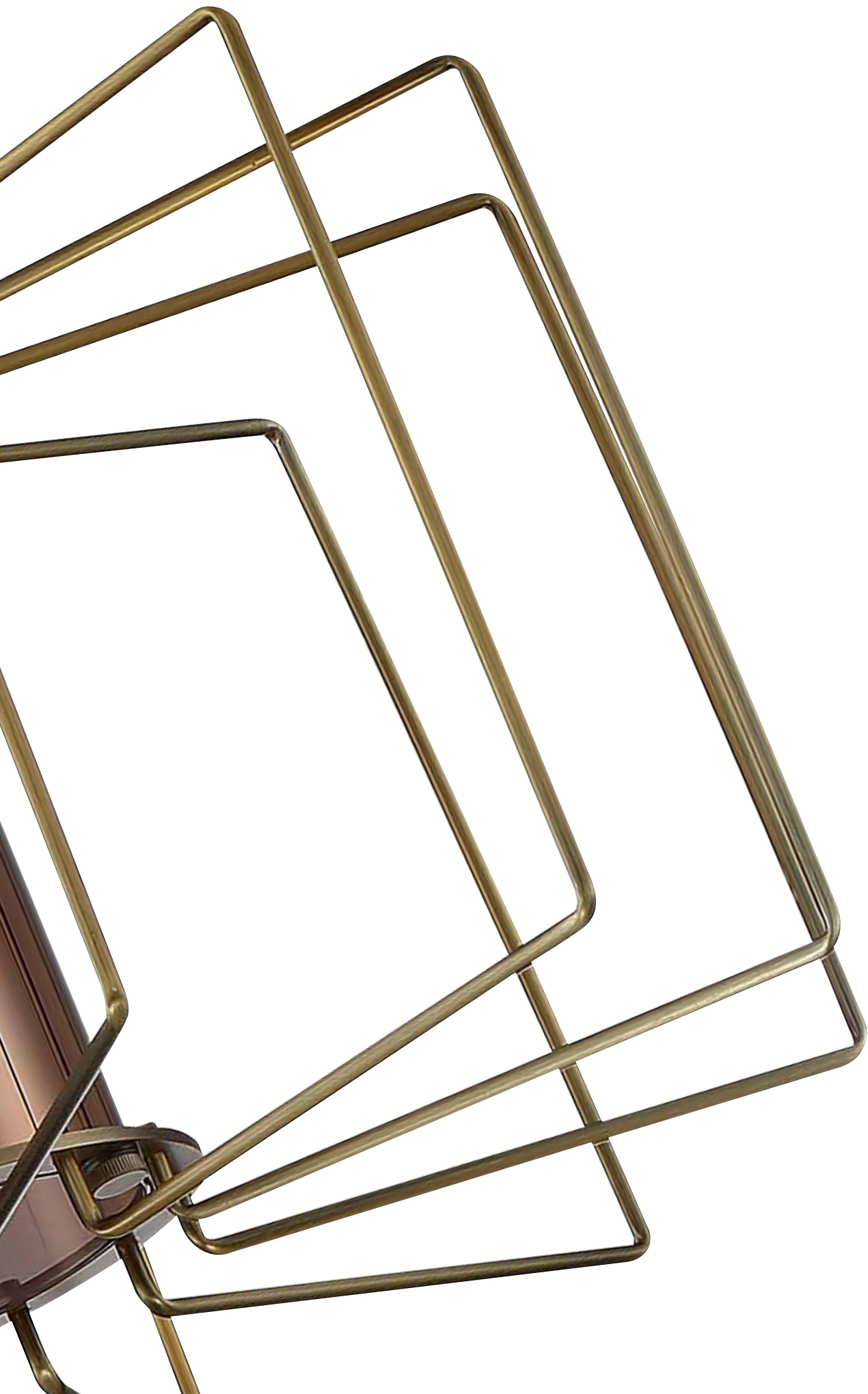





CAN A FIXTURE INSPIRE AN ENTIRE VENUE?

In this case, Zen has done just that. This modern retro style is strong enough to set the style, yet not so serious that it overpowers the space. This is when a fixture can be an inspiration.

ZEN

Matte Black and Brushed Nickel or White

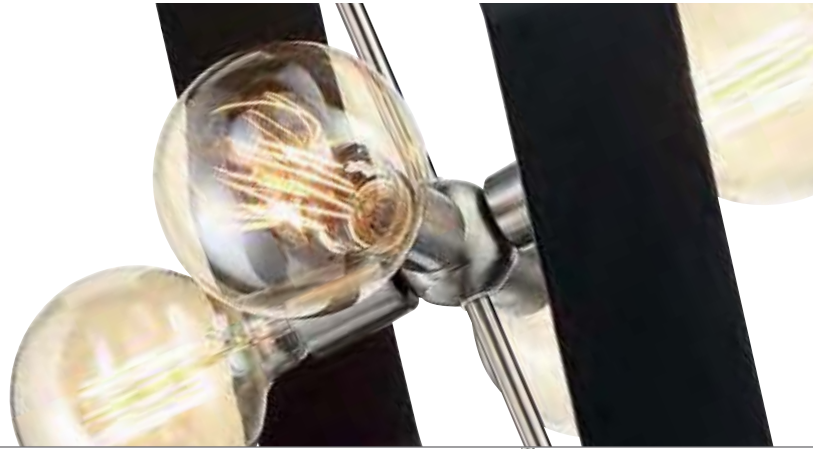

60-6392



60-6391



60-6393

Item#	Description	Finish	No. of Lights	Lamp Type	Base	Max Watts	Length	Width	Height	Ext.	Cert. Type
60-6391	Small Pendant	Black / Brushed Nickel	1	G25	Med.	60W	•	10"	10"	•	Dry
60-6392	Medium Pendant	Black / Brushed Nickel	1	G40	Med.	60W	•	14 1/8"	14 1/8"	•	Dry
60-6393	Large Pendant	Black / Brushed Nickel	4	G25	Med.	60W	•	24"	24"	•	Dry
60-6395	Small Pendant	White	1	G25	Med.	60W	•	10"	10"	•	Dry
60-6396	Medium Pendant	White	1	G40	Med.	60W	•	14 1/8"	14 1/8"	•	Dry
60-6397	Large Pendant	White	4	G25	Med.	60W	•	24"	24"	•	Dry

Additional Stems (Brushed Nickel): (6") 25-4118, (12") 25-4119, Additional Stems (White): (6") 25-5014, (12") 25-5015.
Pendants include 12' of wire.



60-6395



60-6396



60-6397

HAWK LED

Pivoting Heads in Black, White and Brushed Nickel



62-994



62-993



62-992

Item#	Description	Finish	Light Source	Watts	Incand. Equiv.	Length	Width	Height	Ext.	CCT	Lumens	CRI	Cert. Type
62-992	Sconce	White	LED	15	75W	•	6 1/2"	5"	7 5/8"	3000K	1,275*	90	Damp
62-993	Sconce	Black	LED	15	75W	•	6 1/2"	5"	7 5/8"	3000K	1,275*	90	Damp
62-994	Sconce	Brushed Nickel	LED	15	75W	•	6 1/2"	5"	7 5/8"	3000K	1,275*	90	Damp
62-995	Pendant	White	LED	15	75W	•	6 1/2"	2 1/2"	•	3000K	1,275*	90	Dry
62-996	Pendant	Black	LED	15	75W	•	6 1/2"	2 1/2"	•	3000K	1,275*	90	Dry
62-997	Pendant	Brushed Nickel	LED	15	75W	•	6 1/2"	2 1/2"	•	3000K	1,275*	90	Dry

*Lumens measured at LED source.

Pendants include 12' wire and cable.



62-995



62-996

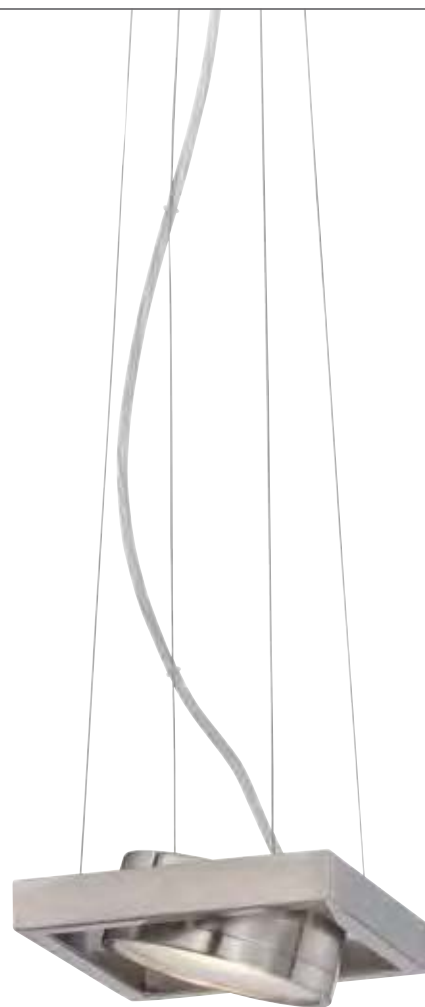

62-997

FANTOM LED

Assorted Colors / Matching braided rayon cord / Frosted Glass

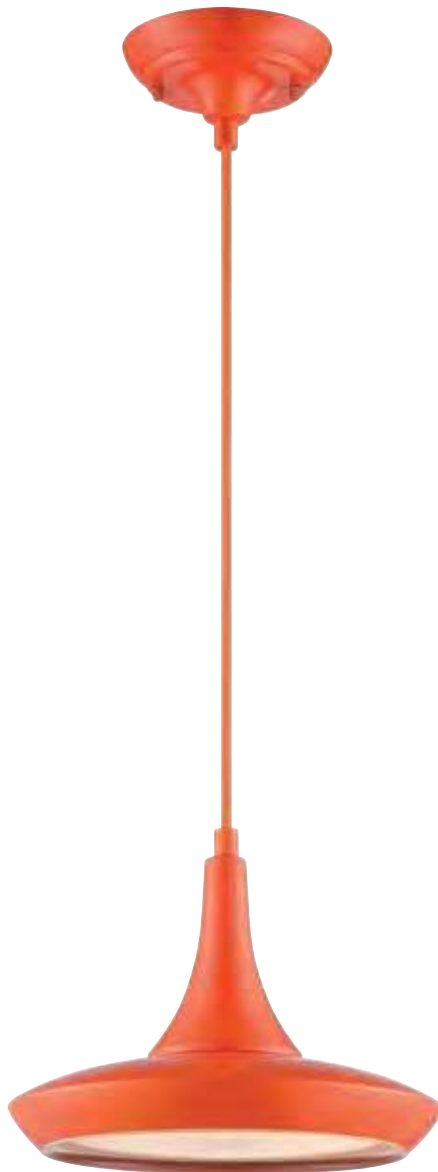

62-446

Item#	Description	Finish	Light Source	Watts	Incand. Equiv.	Length	Width	Height	Ext.	CCT	Lumens	CRI	Cert. Type
62-441	Pendant	Yellow	LED	18 [†]	2x60W	•	10 1/2"	8"	•	3000K	1,500*	90	Dry
62-442	Pendant	White	LED	18 [†]	2x60W	•	10 1/2"	8"	•	3000K	1,500*	90	Dry
62-443	Pendant	Black	LED	18 [†]	2x60W	•	10 1/2"	8"	•	3000K	1,500*	90	Dry
62-444	Pendant	Blue	LED	18 [†]	2x60W		10 1/2"	8"		3000K	1,500*	90	Dry
62-445	Pendant	Green	LED	18 [†]	2x60W		10 1/2"	8"		3000K	1,500*	90	Dry
62-446	Pendant	Orange	LED	18 [†]	2x60W		10 1/2"	8"		3000K	1,500*	90	Dry
62-447	Pendant	Red	LED	18 [†]	2x60W		10 1/2"	8"		3000K	1,500*	90	Dry

*Lumens measured at LED source.

Pendants include 12' color matched rayon cord.





**FUNCTIONAL, BUT WITH
PLENTY OF STYLE.**

Del fixtures make "getting the job done in style" an understatement. Five different glass finishes, all stunning, and LED efficiency combine to deliver substance and style.



DEL LED

Brushed Nickel with Assorted Glass:
Copper, Mirrored, White Opal, Clear Crackle or Antique Gold



62-889
Copper Glass



62-888
Mirrored Glass

Item#	Description	Glass	Light Source	Watts	Incand. Equiv.	Length	Width	Height	Ext.	CCT	Lumens	CRI	Cert. Type
62-877	Mini Pendant	White Opal	LED	12	60W	•	6 ¾"	9 ¼"	•	3000K	1,020*	90	Damp
62-878	Mini Pendant	Crackle	LED	12	60W	•	6 ¾"	9 ¼"	•	3000K	1,020*	90	Damp
62-879	Mini Pendant	Antique Gold	LED	12	60W	•	6 ¾"	9 ¼"	•	3000K	1,020*	90	Damp
62-888	Mini Pendant	Mirrored	LED	12	60W	•	6 ¾"	9 ¼"	•	3000K	1,020*	90	Damp
62-889	Mini Pendant	Copper	LED	12	60W	•	6 ¾"	9 ¼"	•	3000K	1,020*	90	Damp

*Lumens measured at LED source.

Pendants include 12' of black SVT cable.



62-877
White Opal Glass



62-878
Crackle Glass



62-879
Antique Gold Glass



**LESS ENERGY.
MORE COMPLIMENTS.**

Clean design is more than just visual. It's bringing that same thinking inside – to the energy efficient LED module. And the Pulse family does just that.



PULSE LED

Brushed Nickel with Assorted Glass:
Copper, Mirrored, White Opal, Clear Crackle or Clear Seeded



62-955
Copper Glass



62-954
Mirrored Glass

Item#	Description	Glass	Light Source	Watts	Incand. Equiv.	Length	Width	Height	Ext.	CCT	Lumens	CRI	Cert. Type
62-951	Mini Pendant	Clear Seeded	LED	12	60W	•	3"	10"	•	3000K	1,020*	90	Damp
62-952	Mini Pendant	Crackle	LED	12	60W	•	3"	10"	•	3000K	1,020*	90	Damp
62-953	Mini Pendant	White Opal	LED	12	60W	•	3"	10"	•	3000K	1,020*	90	Damp
62-954	Mini Pendant	Mirrored	LED	12	60W	•	3"	10"	•	3000K	1,020*	90	Damp
62-955	Mini Pendant	Copper	LED	12	60W	•	3"	10"	•	3000K	1,020*	90	Damp

*Lumens measured at LED source.

Pendants include 12' of black SVT cable.



62-953
White Opal Glass



62-952
Crackle Glass



62-951
Clear Seeded Glass

LET'S BE OPEN ABOUT DESIGN...

When it's good, it's great. And the Wired family is great. Delicately shaped wire with matching glass create a simple, open design that, at the same time, has great presence.





WIRED LED

Brushed Nickel with Clear Glass, Vintage Brass with Copper Glass,
or Aged Bronze with Mirrored Glass

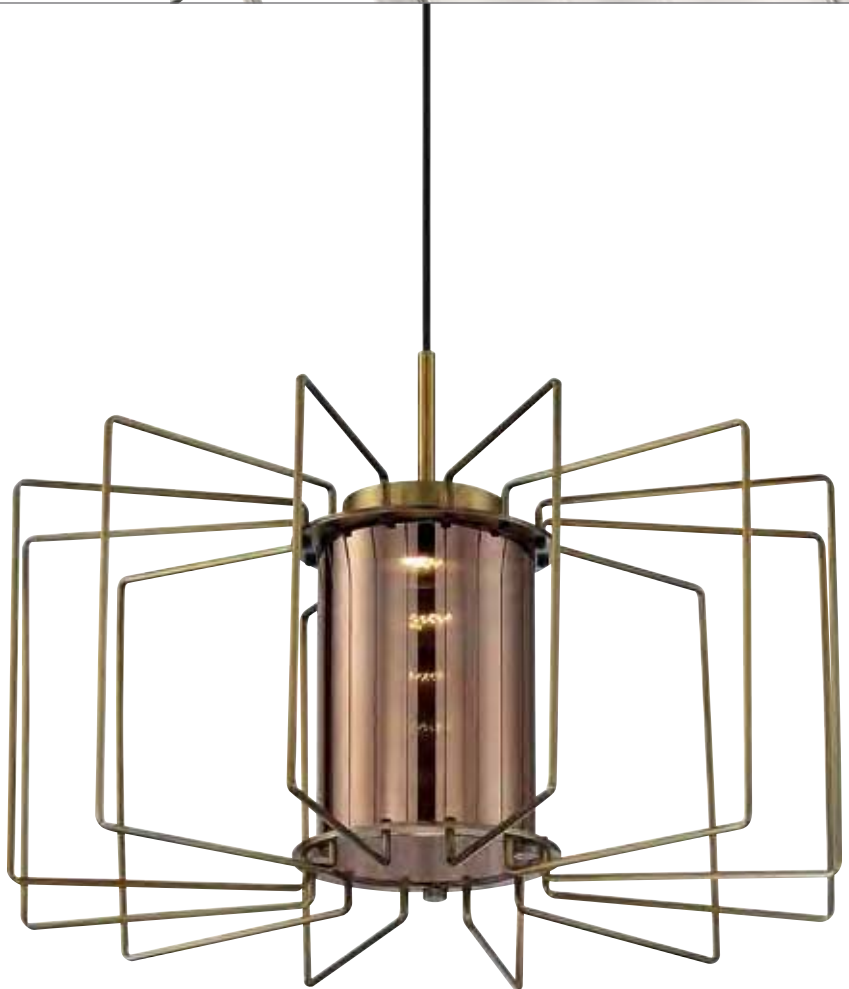

62-1352

Item#	Description	Finish	Light Source	Watts	Incand. Equiv.	Length	Width	Height	Ext.	CCT	Lumens	CRI	Cert. Type
62-1351	Pendant	Brushed Nickel	60W	12	60W	•	20"	9"	•	3000K	1,020*	90	Damp
62-1352	Pendant	Vintage Brass	60W	12	60W	•	20"	9"	•	3000K	1,020*	90	Damp
62-1353	Pendant	Aged Bronze	60W	12	60W	•	20"	9"	•	3000K	1,020*	90	Damp

*Lumens measured at LED source.

Pendants include 12' of black SVT cable.



62-1351



62-1353

ORBIT LED

White or Black



62-1455



62-1458



62-1454



62-1451

Item#	Description	Finish	Light Source	Watts	Incand. Equiv.	Length	Width	Height	Ext.	CCT	Lumens	CRI	Cert. Type
62-1451	Flush	White	LED	20	75W	•	17 ¾"	6 ⅛"	•	3000K	1,300*	90	Dry
62-1452	Flush	Black	LED	20	75W	•	17 ¾"	6 ⅛"	•	3000K	1,300*	90	Dry
62-1453	Flush	White	LED	30	100W	•	23 ½"	6"	•	3000K	1,700*	90	Dry
62-1454	Flush	Black	LED	30	100W	•	23 ½"	6"	•	3000K	1,700*	90	Dry
62-1455	Pendant	White	LED	20	75W	•	17 ¾"	4 ⅜"	•	3000K	1,300*	90	Dry
62-1456	Pendant	Black	LED	20	75W	•	17 ¾"	4 ⅜"	•	3000K	1,300*	90	Dry
62-1457	Pendant	White	LED	30	100W	•	23 ½"	4 ⅜"	•	3000K	1,700*	90	Dry
62-1458	Pendant	Black	LED	30	100W	•	23 ½"	4 ⅜"	•	3000K	1,700*	90	Dry

*Lumens measured at LED source.

Pendants include 12' wire and cable.



62-1456



62-1457



62-1452



62-1453

TASK LED

Black or Wood



62-1461



Built in wave sensor.

Wave hand past sensor to turn bottom light on.
Wave again to turn top light on. Wave a third
time to turn both top and bottom lights on.
Simply wave one last time to turn the fixture off.

Item#	Description	Finish	Light Source	Watts	Incand. Equiv.	Length	Width	Height	Ext.	CCT	Lumens	CRI	Cert. Type
62-1461	Linear Pendant	Black	LED	20	75W	41 1/2"	1 5/8"	2 5/8"	•	3000K	1,300*	90	Dry
62-1462	Flush	Wood	LED	20	75W	48"	2 1/8"	2 7/8"	•	3000K	1,300*	90	Dry

*Lumens measured at LED source.

Pendants include 12' wire and cable.



62-1462

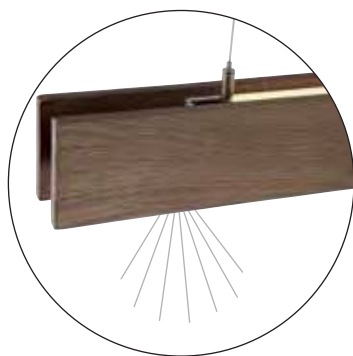

FRAME LED

Brushed Nickel or Hazel Bronze



62-105



62-136



62-106

Item#	Description	Finish	Light Source	Watts	Incand. Equiv.	Length	Width	Height	Ext.	CCT	Lumens	CRI	Cert. Type
62-105	Sconce	Brushed Nickel	LED	10	60W	•	7 7/8"	20 1/4"	4"	3000K	850*	90	Damp
62-106	Pendant	Brushed Nickel	LED	10	60W	7 7/8"	5 5/8"	16 3/4"	•	3000K	850*	90	Damp
62-116	Island Pendant	Hazel Bronze	LED	39	3x75W	36"	4 1/8"	14"	•	3000K	3,315*	90	Damp
62-125	Sconce	Hazel Bronze	LED	10	60W	•	7 7/8"	20 1/4"	4"	3000K	850*	90	Damp
62-126	Pendant	Hazel Bronze	LED	10	60W	7 7/8"	5 5/8"	16 3/4"	•	3000K	850*	90	Damp
62-136	Island Pendant	Brushed Nickel	LED	39	3x75W	36"	4 1/8"	14"	•	3000K	3,315*	90	Damp

*Lumens measured at LED source. Sconces are ADA compliant.

Additional Brushed Nickel pendant stems: (6") 25-2057, (12") 25-2055 Additional Hazel Bronze pendant stems: (6") 25-4121, (12") 25-4122 Pendants include 12' of wire.



62-126



62-116



62-125

LINK

Brushed Nickel / Satin White Glass



60-2936
(horizontal mount)



60-2936
(vertical mount)



60-2934



60-2938

Item#	Description	Finish	No. of Lights	Lamp Type	Base	Max Watts	Length	Width	Height	Ext.	Cert. Type
60-2932	Single Tube Pendant	Brushed Nickel	1	T10	Med.	60W	•	2 ¾"	10 ¾"	•	Dry
60-2934	Single Tube Sconce	Brushed Nickel	1	T10	Med.	60W	•	4 ½"	11 ½"	3 ¾"	Damp
60-2936	Double Tube Sconce	Brushed Nickel	2	T10	Med.	60W	•	4 ½"	21"	3 ¾"	Damp
60-2938	Dual Tube Sconce	Brushed Nickel	2	T10	Med.	60W	•	8"	11 ½"	3 ¾"	Damp
25-4091	3 Lt. Mounting Plate	Brushed Nickel	•	•	•	•	•	36"	5 ½"	•	•

Sconces are ADA compliant.

Brushed Nickel 3 light canopy mounting plate (36" x 5 ½"): 25-4091.
Pendant includes 12' of wire.



(3) 60-2932 pendants (with optional 25-4091 mounting plate)

60-2932

LINK LED

Brushed Nickel / Satin White Glass



62-2936
(horizontal mount)



62-2936
(vertical mount)



62-2934

Item#	Description	Finish	Light Source	Watts	Incand. Equiv.	Length	Width	Height	Ext.	CCT	Lumens	CRI	Cert. Type
62-2932	Single Tube Pendant	Brushed Nickel	LED	12	60W	•	2 ¾"	10 ¾"	•	3000K	1,020*	90	Damp
62-2934	Single Tube Sconce	Brushed Nickel	LED	12	60W	•	4 ½"	11 ½"	3 ¾"	3000K	1,020*	90	Damp
62-2936	Double Tube Sconce	Brushed Nickel	LED	24	2x60W	•	4 ½"	21"	3 ¾"	3000K	2,040*	90	Damp
25-4091	3 Lt. Mounting Plate	Brushed Nickel	•	•	•	•	36"	5 ½"	•	•	•	•	•

*Lumens measured at LED source.
Sconces are ADA compliant.

Brushed Nickel 3 light canopy mounting plate (36" x 5 ½"): **25-4091**.
Pendant includes 12' of wire.



(3) 62-2932 pendants (with optional 25-4091 mounting plate)

62-2932

DORAL LED

Brushed Nickel / White or Bronze / Copper



62-852



62-851

Item#	Description	Finish	Light Source	Watts	Incand. Equiv.	Length	Width	Height	Ext.	CCT	Lumens	CRI	Cert. Type
62-851	Small Pendant	Brushed Nickel	LED	12	60W	•	10"	6"	•	3000K	1,020*	90	Damp
62-852	Large Pendant	Brushed Nickel	LED	15	75W	•	14"	11"	•	3000K	1,275*	90	Damp
62-856	Small Pendant	Bronze	LED	12	60W	•	10"	6"	•	3000K	1,020*	90	Damp
62-857	Large Pendant	Bronze	LED	15	75W	•	14"	11"	•	3000K	1,275*	90	Damp

*Lumens measured at LED source.

Additional Brushed Nickel Stems: (6") 25-2057, (12") 25-2055 Additional Bronze Stems: (6") 25-4171, (12") 25-4172. Pendants include 12' of wire.



62-856



62-857

VESSEL LED

Brushed Nickel / White or Bronze / Copper



62-837

Item#	Description	Finish	Light Source	Watts	Incand. Equiv.	Length	Width	Height	Ext.	CCT	Lumens	CRI	Cert. Type
62-837	Mini Pendant	Brushed Nickel	LED	12	60W	•	6"	8 ½"	•	3000K	1,020*	90	Damp
62-838	Mini Pendant	Bronze	LED	12	60W	•	6"	8 ½"	•	3000K	1,020*	90	Damp

*Lumens measured at LED source.

Pendants include 12' of black SVT cable.



62-838

TEX LED

Brushed Nickel with Black Mesh or Bronze with Copper Mesh



62-882



62-881

Item#	Description	Finish	Light Source	Watts	Incand. Equiv.	Length	Width	Height	Ext.	CCT	Lumens	CRI	Cert. Type
62-881	Small Pendant	Brushed Nickel	LED	12	60W	•	8 ¼"	8"	•	3000K	1,020*	90	Damp
62-882	Large Pendant	Brushed Nickel	LED	15	75W	•	13 ½"	12"	•	3000K	1,275*	90	Damp
62-886	Small Pendant	Bronze	LED	12	60W	•	8 ¼"	8"	•	3000K	1,020*	90	Damp
62-887	Large Pendant	Bronze	LED	15	75W	•	13 ½"	12"	•	3000K	1,275*	90	Damp

*Lumens measured at LED source.

Additional Brushed Nickel Stems: (6") 25-2057, (12") 25-2055 Additional Bronze Stems: (6") 25-4171, (12") 25-4172. Pendants include 12' of wire.



62-886



62-887

MAXX

Polished Nickel or Mahogany Bronze



60-5838



60-5839



60-5837



ST19 Vintage
lamps included

Item#	Description	Finish	No. of Lights	Lamp Type	Base	Max Watts	Length	Width	Height	Ext.	Cert. Type
60-5837	Small Pendant	Polished Nickel	1	A19†	Med.	60W	•	7 ¼"	8 ½"	•	Dry
60-5838	Medium Pendant	Polished Nickel	1	A19†	Med.	60W	•	8 ½"	9 ½"	•	Dry
60-5839	Large Pendant	Polished Nickel	1	A19†	Med.	60W	•	10 ¾"	13"	•	Dry
60-5847	Small Pendant	Mahogany Bronze	1	A19†	Med.	60W	•	7 ¼"	8 ½"	•	Dry
60-5848	Medium Pendant	Mahogany Bronze	1	A19†	Med.	60W	•	8 ½"	9 ½"	•	Dry
60-5849	Large Pendant	Mahogany Bronze	1	A19†	Med.	60W	•	10 ¾"	13"	•	Dry

†60W T9 S2423 Vintage lamps included.

Additional Polished Nickel Stems: (6") 25-4118, (12") 25-4119 Additional Mahogany Bronze Stems: (6") 25-2078, (12") 25-2079. Pendants include 12' of wire.



60-5847



60-5848



60-5849

LED SCONCES

Aged Bronze or Black / Assorted Glass



62-1404



62-1401



62-1402

Item#	Name / Glass	Finish	Light Source	Watts	Incand. Equiv.	Length	Width	Height	Ext.	CCT	Lumens	CRI	Cert. Type
62-1401	"Reflex"	Aged Bronze	LED	30	3x75W	•	8"	22"	2 ¾"	3000K	2,550*	90	Damp
62-1402	"Lucas" / Water Glass	Black	LED	15	75W	•	6"	16 ½"	2 ¾"	3000K	1,275*	90	Damp
62-1403	"Zorin" / Crackle Glass	Black	LED	15	75W	•	6 ¾"	15"	3"	3000K	1,275*	90	Damp
62-1404	"Chaz"	Aged Bronze	LED	18	2x60W	•	6 ¾"	26"	3"	3000K	1,500*	90	Damp
62-1405	"Petra" / Ice Glass	Black	LED	26	3x60W	•	8"	27 ½"	3 ¼"	3000K	2,210*	90	Damp
62-1406	"Kinsey" / Ribbed Glass	Aged Bronze	LED	16	2x60W	•	4 ¾"	14"	3 ¾"	3000K	1,360*	90	Damp

*Lumens measured at LED source.
 ADA compliant. Indoor use only.



62-1406



62-1403



62-1405

LED SCONCES

Hazel Bronze or Brushed Nickel



62-104



62-124

Item#	Name / Glass	Finish	Light Source	Watts	Incand. Equiv.	Length	Width	Height	Ext.	CCT	Lumens	CRI	Cert. Type
62-102	"Trax" Sconce	Brushed Nickel	LED	10	60W	•	7"	20"	3 1/2"	3000K	850*	82	Damp
62-104	"Wave" Sconce	Brushed Nickel	LED	10	60W	•	7 7/8"	17"	4"	3000K	850*	82	Damp
62-122	"Trax" Sconce	Hazel Bronze	LED	10	60W	•	7"	20"	3 1/2"	3000K	850*	82	Damp
62-124	"Wave" Sconce	Hazel Bronze	LED	10	60W	•	7 7/8"	17"	4"	3000K	850*	82	Damp

*Lumens measured at LED source.
 ADA compliant. Indoor use only.



62-122



62-102

MERCER LED

Polished Nickel, Georgetown Bronze
and Brushed Nickel / Frosted Glass



62-311



62-314



62-317

Item#	Description	Finish	Light Source	Watts	Incand. Equiv.	Length	Width	Height	Ext.	CCT	Lumens	CRI	Cert. Type
62-311	1 Light Sconce	Polished Nickel	LED	10	60W	•	10"	4 1/8"	3 1/2"	3000K	850*	90	Damp
62-312	2 Light Sconce	Polished Nickel	LED	20	2x60W	•	20 1/2"	4 1/8"	3 1/2"	3000K	1,700*	90	Damp
62-313	3 Light Sconce	Polished Nickel	LED	30	3x60W	•	27 7/8"	4"	3 1/2"	3000K	2,550*	90	Damp
62-314	1 Light Sconce	Georgetown Bronze	LED	10	60W	•	10"	4 1/8"	3 1/2"	3000K	850*	90	Damp
62-315	2 Light Sconce	Georgetown Bronze	LED	20	2x60W	•	20 1/2"	4 1/8"	3 1/2"	3000K	1,700*	90	Damp
62-316	3 Light Sconce	Georgetown Bronze	LED	30	3x60W	•	27 7/8"	4"	3 1/2"	3000K	2,550*	90	Damp
62-317	1 Light Sconce	Brushed Nickel	LED	10	60W	•	10"	4 1/8"	3 1/2"	3000K	850*	90	Damp
62-318	2 Light Sconce	Brushed Nickel	LED	20	2x60W	•	20 1/2"	4 1/8"	3 1/2"	3000K	1,700*	90	Damp
62-319	3 Light Sconce	Brushed Nickel	LED	30	3x60W	•	27 7/8"	4"	3 1/2"	3000K	2,550*	90	Damp

*Lumens measured at LED source.
ADA compliant.



62-315



62-312



62-318



62-313



62-316



62-319

Item#	Description	Finish	Light Source	Watts	Incand. Equiv.	Length	Width	Height	Ext.	CCT	Lumens	CRI	Cert. Type
62-1327	Sconce	Brushed Nickel	LED	13	60W	•	12 1/2"	4 1/2"	2"	3000K	1,105*	90	Damp
62-1328	Vanity	Brushed Nickel	LED	26	2x60W	•	24"	4 1/2"	2"	3000K	2,210*	90	Damp
62-1329	Vanity	Brushed Nickel	LED	39	3x60W	•	35 1/2"	4 1/2"	2"	3000K	3,315*	90	Damp

*Lumens measured at LED source.
ADA Compliant.

JACKSON LED

Brushed Nickel / White Acrylic Lens



62-1329



62-1328



62-1327

Item#	Description	Finish	Light Source	Watts	Incand. Equiv.	Length	Width	Height	Ext.	CCT	Lumens	CRI	Cert. Type
62-1330	Sconce	Brushed Nickel	LED	13	60W	•	12 1/2"	4 1/2"	2"	3000K	1,105*	90	Damp
62-1331	Vanity	Brushed Nickel	LED	26	2x60W	•	25"	4 1/2"	2"	3000K	2,210*	90	Damp
62-1332	Vanity	Brushed Nickel	LED	39	3x60W	•	36"	4 1/2"	2"	3000K	3,315*	90	Damp

*Lumens measured at LED source.
ADA Compliant.

JESS LED

Brushed Nickel / White Acrylic Lens



62-1332



62-1331



62-1330

Item#	Description	Finish	Light Source	Watts	Incand. Equiv.	Length	Width	Height	Ext.	CCT	Lumens	CRI	Cert. Type
62-1321	Sconce	Brushed Nickel	LED	13	60W	•	13"	4 ½"	3"	3000K	1,105*	90	Damp
62-1322	Vanity	Brushed Nickel	LED	26	2x60W	•	25 ½"	4 ½"	3"	3000K	2,210*	90	Damp
62-1323	Vanity	Brushed Nickel	LED	39	3x60W	•	36 ¼"	4 ½"	3"	3000K	3,315*	90	Damp

*Lumens measured at LED source.
ADA Compliant.

BEND LED

Brushed Nickel / White Acrylic Lens



62-1323



62-1322



62-1321

Item#	Description	Finish	Light Source	Watts	Incand. Equiv.	Length	Width	Height	Ext.	CCT	Lumens	CRI	Cert. Type
62-1324	Sconce	Polished Nickel	LED	13	60W	•	14 1/4"	4 1/2"	3 3/4"	3000K	1,105*	90	Damp
62-1325	Vanity	Polished Nickel	LED	26	2x60W	•	25 3/4"	4 1/2"	3 3/4"	3000K	2,210*	90	Damp
62-1326	Vanity	Polished Nickel	LED	39	3x60W	•	36 3/4"	4 1/2"	3 3/4"	3000K	3,315*	90	Damp

*Lumens measured at LED source.
ADA Compliant.

LANA LED

Polished Nickel / White Acrylic Lens



62-1326



62-1325



62-1324

Item#	Description	Finish	Light Source	Watts	Incand. Equiv.	Length	Width	Height	Ext.	CCT	Lumens	CRI	Cert. Type
62-731	Sconce	Brushed Nickel	LED	10	60W	•	6"	9 1/2"	4"	3000K	850*	90	Damp
62-732	Sconce / Vanity	Brushed Nickel	LED	20	2x60W	•	6"	17 1/2"	4"	3000K	1,700*	90	Damp
62-733	Large Sconce	Brushed Nickel	LED	13	75W	•	6"	19 1/2"	4"	3000K	1,105*	90	Damp
62-734	Vanity	Brushed Nickel	LED	26	2x75W	•	6"	37 3/8"	4"	3000K	2,210*	90	Damp

*Lumens measured at LED source.
ADA compliant.

BOND LED

Brushed Nickel / White Acrylic Lens

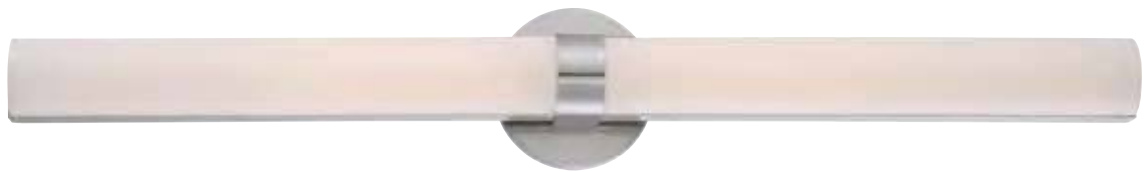

62-734

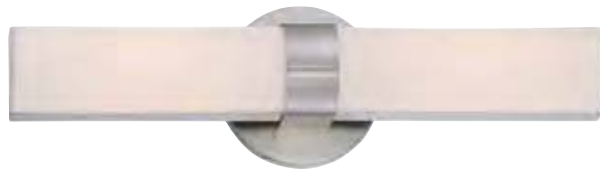

62-732
(horizontal mount)



62-732
(vertical mount)



62-731



62-733

Item#	Description	Finish	Light Source	Watts	Incand. Equiv.	Length	Width	Height	Ext.	CCT	Lumens	CRI	Cert. Type
62-741	Sconce	Aged Bronze	LED	10	60W	•	6"	9 1/2"	4"	3000K	850*	90	Damp
62-742	Sconce / Vanity	Aged Bronze	LED	20	2x60W	•	6"	17 1/2"	4"	3000K	1,700*	90	Damp
62-743	Large Sconce	Aged Bronze	LED	13	75W	•	6"	19 1/2"	4"	3000K	1,105*	90	Damp
62-744	Vanity	Aged Bronze	LED	26	2x75W	•	6"	37 3/8"	4"	3000K	2,210*	90	Damp

*Lumens measured at LED source.
ADA compliant.

BOND LED

Aged Bronze / White Acrylic Lens



62-744



62-742
(vertical mount)



62-742
(horizontal mount)



62-741



62-743

Item#	Description	Finish	Light Source	Watts	Incand. Equiv.	Length	Width	Height	Ext.	CCT	Lumens	CRI	Cert. Type
62-721	Sconce	Polished Nickel	LED	10	60W	•	6"	9 1/2"	4"	3000K	850*	90	Damp
62-722	Sconce / Vanity	Polished Nickel	LED	20	2x60W	•	6"	17 1/2"	4"	3000K	1,700*	90	Damp
62-723	Large Sconce	Polished Nickel	LED	13	75W	•	6"	19 1/2"	4"	3000K	1,105*	90	Damp
62-724	Vanity	Polished Nickel	LED	26	2x75W	•	6"	37 3/8"	4"	3000K	2,210*	90	Damp

*Lumens measured at LED source.
ADA compliant.

BOND LED

Polished Nickel / White Acrylic Lens



62-724



62-722
(vertical mount)



62-722
(horizontal mount)



62-721



62-723

Item#	Description	Finish	Light Source	Watts	Incand. Equiv.	Length	Width	Height	Ext.	CCT	Lumens	CRI	Cert. Type
62-185	Sconce	Brushed Nickel	LED	10	60W	•	6"	11 1/2"	3 3/4"	3000K	850*	90	Damp
62-186	Sconce	Aged Bronze	LED	10	60W	•	6"	11 1/2"	3 3/4"	3000K	850*	90	Damp

*Lumens measured at LED source.
ADA compliant.

TUCKER LED

Brushed Nickel or Aged Bronze / Etched Opal Glass



62-185



62-186

GRILL LED

Polished Nickel or Aged Bronze / White Acrylic Lens



62-871



62-875



62-872

Item#	Description	Finish	Light Source	Watts	Incand. Equiv.	Length	Width	Height	Ext.	CCT	Lumens	CRI	Cert. Type
62-871	12" Sconce	Polished Nickel	LED	13	75W	•	4"	12"	3"	3000K	1,105*	90	Damp
62-872	24" Vanity	Polished Nickel	LED	26	2x75W	•	24"	4"	3"	3000K	2,210*	90	Damp
62-873	12" Sconce	Aged Bronze	LED	13	75W	•	4"	12"	3"	3000K	1,105*	90	Damp
62-874	24" Vanity	Aged Bronze	LED	26	2x75W	•	24"	4"	3"	3000K	2,210*	90	Damp
62-875	36" Vanity	Polished Nickel	LED	39	3x75W	•	36"	4"	3"	3000K	3,315*	90	Damp
62-876	36" Vanity	Aged Bronze	LED	39	3x75W	•	36"	4"	3"	3000K	3,315*	90	Damp

*Lumens measured at LED source.
ADA compliant.



62-873



62-876



62-874

PACE LED

Brushed Nickel or Aged Bronze / White Acrylic Lens



62-911



62-915



62-912

Item#	Description	Finish	Light Source	Watts	Incand. Equiv.	Length	Width	Height	Ext.	CCT	Lumens	CRI	Cert. Type
62-911	12" Vanity	Brushed Nickel	LED	13	75W	•	5"	12"	3 ¼"	3000K	1,105*	90	Damp
62-912	24" Vanity	Brushed Nickel	LED	26	2x75W	•	24"	5"	3 ¼"	3000K	2,210*	90	Damp
62-913	12" Vanity	Aged Bronze	LED	13	75W	•	5"	12"	3 ¼"	3000K	1,105*	90	Damp
62-914	24" Vanity	Aged Bronze	LED	26	2x75W	•	24"	5"	3 ¼"	3000K	2,210*	90	Damp
62-915	36" Vanity	Brushed Nickel	LED	39	3x75W	•	36"	5"	3 ¼"	3000K	3,315*	90	Damp
62-916	36" Vanity	Aged Bronze	LED	39	3x75W	•	36"	5"	3 ¼"	3000K	3,315*	90	Damp

*Lumens measured at LED source.
ADA compliant.



62-913



62-916



62-914

LOOP LED

Brushed Nickel or Aged Bronze / White Acrylic Lens



62-921



62-925



62-922

Item#	Description	Finish	Light Source	Watts	Incand. Equiv.	Length	Width	Height	Ext.	CCT	Lumens	CRI	Cert. Type
62-921	12" Sconce	Brushed Nickel	LED	13	75W	•	4"	12"	3 1/8"	3000K	1,105*	90	Damp
62-922	24" Vanity	Brushed Nickel	LED	26	2x75W	•	24"	4"	3 1/8"	3000K	2,210*	90	Damp
62-923	12" Sconce	Aged Bronze	LED	13	75W	•	4"	12"	3 1/8"	3000K	1,105*	90	Damp
62-924	24" Vanity	Aged Bronze	LED	26	2x75W	•	24"	4"	3 1/8"	3000K	2,210*	90	Damp
62-925	36" Vanity	Brushed Nickel	LED	39	3x75W	•	36"	4"	3 1/8"	3000K	3,315*	90	Damp
62-926	36" Vanity	Aged Bronze	LED	39	3x75W	•	36"	4"	3 1/8"	3000K	3,315*	90	Damp

*Lumens measured at LED source.
ADA compliant.



62-923



62-926



62-924



LEAN AND CLEAN.

The clean, contemporary design and efficient LED operation of our Slice vanity series make them very popular for both residential and hospitality applications. Finished in Polished Nickel, Slice fixtures blend well in a variety of styles, yet make their presence known through energy savings and tasteful lighting design.



SLICE LED

Polished Nickel or Aged Bronze / White Acrylic Lens



62-931



62-935



62-932

Item#	Description	Finish	Light Source	Watts	Incand. Equiv.	Length	Width	Height	Ext.	CCT	Lumens	CRI	Cert. Type
62-931	12" Sconce	Polished Nickel	LED	13	75W	•	4 1/2"	12"	3"	3000K	1,105*	90	Damp
62-932	24" Vanity	Polished Nickel	LED	26	2x75W	•	24"	4 1/2"	3"	3000K	2,210*	90	Damp
62-933	12" Sconce	Aged Bronze	LED	13	75W	•	4 1/2"	12"	3"	3000K	1,105*	90	Damp
62-934	24" Vanity	Aged Bronze	LED	26	2x75W	•	24"	4 1/2"	3"	3000K	2,210*	90	Damp
62-935	36" Vanity	Polished Nickel	LED	39	3x75W	•	36"	4 1/2"	3"	3000K	3,315*	90	Damp
62-936	36" Vanity	Aged Bronze	LED	39	3x75W	•	36"	4 1/2"	3"	3000K	3,315*	90	Damp

*Lumens measured at LED source.
ADA compliant.



62-933



62-936



62-934

Item#	Description	Finish	Light Source	Watts	Incand. Equiv.	Length	Width	Height	Ext.	CCT	Lumens	CRI	Cert. Type
62-1101	Vanity	Polished Nickel	LED	13	75W	•	13"	4 1/2"	2 7/8"	3000K	1,105*	90	Damp
62-1102	Vanity	Polished Nickel	LED	26	2x75W	•	25"	4 1/2"	2 7/8"	3000K	2,210*	90	Damp
62-1103	Vanity	Polished Nickel	LED	39	3x75W	•	36"	4 1/2"	2 7/8"	3000K	3,315*	90	Damp

*Lumens measured at LED source.
ADA Compliant.

SLICK LED

Polished Nickel / White Acrylic Lens



62-1101



62-1102



62-1103

Item#	Description	Finish	Light Source	Watts	Incand. Equiv.	Length	Width	Height	Ext.	CCT	Lumens	CRI	Cert. Type
62-1131	Vanity	Polished Nickel	LED	13	75W	•	14 ¼"	5 ½"	5"	3000K	1,105*	90	Damp
62-1132	Vanity	Polished Nickel	LED	26	2x75W	•	25 ¾"	5 ½"	5"	3000K	2,210*	90	Damp
62-1133	Vanity	Polished Nickel	LED	39	3x75W	•	37 ½"	5 ½"	5"	3000K	3,315*	90	Damp

*Lumens measured at LED source.

SABER LED

Polished Nickel / White Acrylic Lens



62-1131



62-1132



62-1133

Item#	Description	Finish	Light Source	Watts	Incand. Equiv.	Length	Width	Height	Ext.	CCT	Lumens	CRI	Cert. Type
62-1081	Vanity	Brushed Nickel	LED	13	75W	•	20"	4 1/4"	2 3/4"	3000K	1,105*	90	Damp
62-1082	Vanity	Brushed Nickel	LED	26	2x75W	•	31"	4 1/4"	2 3/4"	3000K	2,210*	90	Damp
62-1083	Vanity	Brushed Nickel	LED	39	3x75W	•	43"	4 1/4"	2 3/4"	3000K	3,315*	90	Damp

*Lumens measured at LED source.
ADA Compliant.

BOW LED

Brushed Nickel / White Acrylic Lens



62-1081



62-1082



62-1083

Item#	Description	Finish	Light Source	Watts	Incand. Equiv.	Length	Width	Height	Ext.	CCT	Lumens	CRI	Cert. Type
62-1091	Vanity	Polished Nickel	LED	13	75W	•	16"	4 1/2"	2 7/8"	3000K	1,105*	90	Damp
62-1092	Vanity	Polished Nickel	LED	26	2x75W	•	25"	4 1/2"	2 7/8"	3000K	2,210*	90	Damp
62-1093	Vanity	Polished Nickel	LED	39	3x75W	•	37"	4 1/2"	2 7/8"	3000K	3,315*	90	Damp

*Lumens measured at LED source.
ADA Compliant.

SURF LED

Polished Nickel / White Acrylic Lens



62-1091



62-1092



62-1093

VOTIVE

Polished Nickel / Clear, Crystal Cut Glass



60-6444



60-6441

Item#	Description	Finish	No. of Lights	Lamp Type	Base	Max Watts	Length	Width	Height	Ext.	Cert. Type
60-6441	1 Lt. Vanity	Polished Nickel	1	G16 ½	Cand.	60W	•	4 7/8"	5 1/2"	5 5/8"	Damp
60-6442	2 Lt. Vanity	Polished Nickel	2	G16 ½	Cand.	60W	•	10 3/4"	5 3/4"	5 5/8"	Damp
60-6443	3 Lt. Vanity	Polished Nickel	3	G16 ½	Cand.	60W	•	17 7/8"	5 3/4"	5 5/8"	Damp
60-6444	4 Lt. Vanity	Polished Nickel	4	G16 ½	Cand.	60W	•	25"	5 3/4"	5 5/8"	Damp



60-6442



60-6443

Item#	Description	Finish	No. of Lights	Lamp Type	Base	Max Watts	Length	Width	Height	Ext.	Cert. Type
60-5171	1 Lt. Vanity	Polished Nickel	1	A19	Med.	100W	•	6 ¾"	7 ¾"	5 ¾"	Damp
60-5172	2 Lt. Vanity	Polished Nickel	2	A19	Med.	100W	•	16 ½"	8 ¼"	5 ¼"	Damp
60-5173	3 Lt. Vanity	Polished Nickel	3	A19	Med.	100W	•	24"	8 ¼"	5 ¼"	Damp
60-5174	4 Lt. Vanity	Polished Nickel	4	A19	Med.	60W	•	32 ⅝"	8 ¼"	5 ¼"	Damp

BREEZE

Polished Nickel / Etched Opal Glass



60-5172



60-5171



60-5173



60-5174

Item#	Description	Finish	No. of Lights	Lamp Type	Base	Max Watts	Length	Width	Height	Ext.	Cert. Type
60-5181	1 Lt. Vanity	Polished Nickel	1	A19	Med.	100W	•	4 1/2"	8"	5 3/8"	Damp
60-5182	2 Lt. Vanity	Polished Nickel	2	A19	Med.	100W	•	15 1/2"	8"	5 3/8"	Damp
60-5183	3 Lt. Vanity	Polished Nickel	3	A19	Med.	100W	•	23 3/8"	8"	5 3/8"	Damp
60-5184	4 Lt. Vanity	Polished Nickel	4	A19	Med.	60W	•	32 3/8"	8"	5 3/8"	Damp

VISTA

Polished Nickel / Etched Opal Glass



60-5181



60-5182



60-5183



60-5184

Item#	Description	Finish	No. of Lights	Lamp Type	Base	Max Watts	Length	Width	Height	Ext.	Cert. Type
60-5177	3 Lt. Vanity	Polished Nickel	3	Halogen	G9	40W	•	24"	5 ¾"	5"	Damp
60-5178	5 Lt. Vanity	Polished Nickel	5	Halogen	G9	40W	•	36"	5 ¾"	5"	Damp

*40w G9 S4641 halogen lamp(s) included.

LYNNE

Polished Nickel / Frosted Glass



60-5177



60-5178



*G9 Halogen lamps included

Item#	Description	Finish	No. of Lights	Lamp Type	Base	Max Watts	Length	Width	Height	Ext.	Cert. Type
60-5187	3 Lt. Vanity	Brushed Nickel	3	Halogen	G9	40W	•	24"	5 3/8"	5 1/4"	Damp
60-5188	5 Lt. Vanity	Brushed Nickel	5	Halogen	G9	40W	•	36"	5 3/8"	5 1/4"	Damp

*40w G9 S4641 halogen lamp(s) included.

YOGI

Brushed Nickel / Frosted Glass



60-5187



60-5188



*G9 Halogen lamps included

PI LED

Brushed Nickel or Black / Etched Glass



62-460



62-459



62-458

Item#	Description	Finish	Light Source	Watts	Incand. Equiv.	Length	Width	Height	Ext.	CCT	Lumens	CRI	Cert. Type
62-458	9" Flush	Brushed Nickel	LED	18	75W	•	9"	3 1/8"	•	3000K	1,500*	90	Damp
62-459	11" Flush	Brushed Nickel	LED	25	75W	•	11"	3 1/8"	•	3000K	2,125*	90	Damp
62-460	14" Flush	Brushed Nickel	LED	25	75W	•	14"	3 1/8"	•	3000K	2,125*	90	Damp
62-468	9" Flush	Black	LED	18	75W	•	9"	3 1/8"	•	3000K	1,500*	90	Damp
62-469	11" Flush	Black	LED	25	75W	•	11"	3 1/8"	•	3000K	2,125*	90	Damp
62-470	14" Flush	Black	LED	25	75W	•	14"	3 1/8"	•	3000K	2,125*	90	Damp

*Lumens measured at LED source.



62-470



62-469



62-468

Item#	Description	Finish	Light Source	Watts	Incand. Equiv.	Length	Width	Height	Ext.	CCT	Lumens	CRI	Cert. Type
62-771	Flush	Polished Nickel	LED	18	75W	•	9"	4"	•	3000K	1,500*	90	Damp
62-772	Flush	Brushed Nickel	LED	18	75W	•	9"	4"	•	3000K	1,500*	90	Damp
62-773	Flush	Aged Bronze	LED	18	75W	•	9"	4"	•	3000K	1,500*	90	Damp
62-774	Flush	Polished Nickel	LED	18	75W	•	13"	4"	•	3000K	1,500*	90	Damp
62-775	Flush	Brushed Nickel	LED	18	75W	•	13"	4"	•	3000K	1,500*	90	Damp
62-776	Flush	Aged Bronze	LED	18	75W	•	13"	4"	•	3000K	1,500*	90	Damp

*Lumens measured at LED source.

PERK LED

Polished Nickel, Brushed Nickel or Aged Bronze / White Glass



62-771



62-773



62-772



62-774



62-776



62-775

Item#	Description	Finish	Light Source	Watts	Incand. Equiv.	Length	Width	Height	Ext.	CCT	Lumens	CRI	Cert. Type
62-524	Flush	Brushed Nickel	LED	18	2x60W	•	13"	3 7/8"	•	3000K	1,500*	90	Damp
62-525	Flush	Aged Bronze	LED	18	2x60W	•	13"	3 7/8"	•	3000K	1,500*	90	Damp
62-526	Flush	Polished Nickel	LED	18	2x60W	•	13"	3 7/8"	•	3000K	1,500*	90	Damp

*Lumens measured at LED source.

HEATHER LED

Brushed Nickel, Polished Nickel, or Aged Bronze / White Linen Shade



62-524



62-526



62-525

Item#	Description	Finish	Light Source	Watts	Incand. Equiv.	Length	Width	Height	Ext.	CCT	Lumens	CRI	Cert. Type
62-609	Flush	Brushed Nickel	LED	18	2x60W	•	13"	2"	•	3000K	1,500*	90	Damp
62-709	Flush	Aged Bronze	LED	18	2x60W	•	13"	2"	•	3000K	1,500*	90	Damp

*Lumens measured at LED source.

DALE LED

Brushed Nickel or Aged Bronze / Opal Frosted Glass



62-609



62-709

Item#	Description	Finish	Light Source	Watts	Incand. Equiv.	Length	Width	Height	Ext.	CCT	Lumens	CRI	Cert. Type
62-611	Flush	Brushed Nickel	LED	18	2x60W	•	13"	3 ½"	•	3000K	1,500*	90	Damp
62-711	Flush	Aged Bronze	LED	18	2x60W	•	13"	3 ½"	•	3000K	1,500*	90	Damp

*Lumens measured at LED source.

HALEY LED

Brushed Nickel or Aged Bronze / Frosted Glass



62-611



62-711

Item#	Description	Finish	Light Source	Watts	Incand. Equiv.	Length	Width	Height	Ext.	CCT	Lumens	CRI	Cert. Type
62-1042	12" Flush	Brushed Nickel	LED	18	75W	•	11"	3 7/8"	•	3000K	1,440*	90	Damp
62-1043	13" Flush	Brushed Nickel	LED	18	75W	•	13 3/8"	4"	•	3000K	1,440*	90	Damp
62-1044	17" Flush	Brushed Nickel	LED	25	2x60W	•	17"	5"	•	3000K	2,000*	90	Damp
62-1442	12" Flush	Black	LED	18	75W	•	11"	3 7/8"	•	3000K	1,440*	90	Damp
62-1443	13" Flush	Black	LED	18	75W	•	13 3/8"	4"	•	3000K	1,440*	90	Damp
62-1444	17" Flush	Black	LED	25	2x60W	•	17"	5"	•	3000K	2,000*	90	Damp

*Lumens measured at LED source.

BUTTON LED

Brushed Nickel or Black / Satin White Glass



62-1042



62-1043



62-1044



62-1442



62-1443



62-1444

Item#	Description	Finish	Light Source	Watts	Incand. Equiv.	Length	Width	Height	Ext.	CCT	Lumens	CRI	Cert. Type
62-786	120-277V 12" Flush	Brushed Nickel	LED	18	75W	•	11 ¾"	4 ½"	•	3000K	1,080*	90	Damp
62-787	120-277V 12" Flush	Mahogany Bronze	LED	18	75W	•	11 ¾"	4 ½"	•	3000K	1,080*	90	Damp
62-788	120-277V 14" Flush	Brushed Nickel	LED	24	100W	•	14"	5 ½"	•	3000K	1,440*	90	Damp
62-789	120-277V 14" Flush	Mahogany Bronze	LED	24	100W	•	14"	5 ½"	•	3000K	1,440*	90	Damp

*Lumens measured at LED source. **Dimmable at 120V only.

120-277V FLUSH LED

Brushed Nickel or Mahogany Bronze / Frosted Twist and Lock Glass



62-786



62-788



62-787



62-789

LED DRUM FIXTURES

Polished Nickel or Natural Brass / White Fabric Shade /
Beige Fabric Shade / Acrylic Diffuser

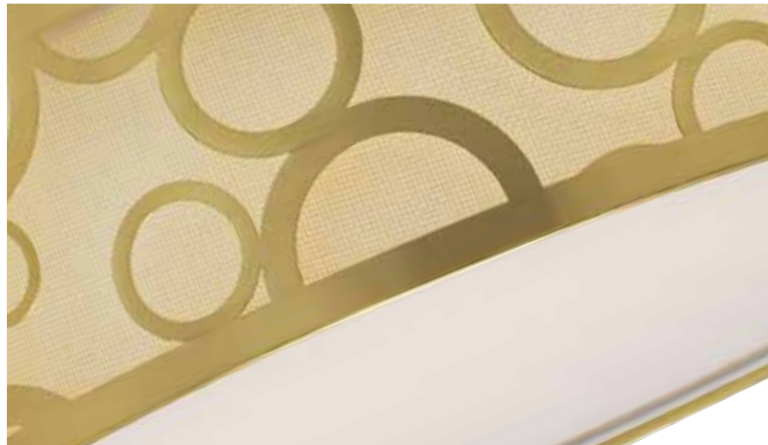

62-987R1



62-986R1



62-985R1

Item#	Description	Finish	Light Source	Watts	Incand. Equiv.	Length	Width	Height	Ext.	CCT	Lumens	CRI	Cert. Type
62-985R1	Flush – Beige Fabric	•	LED	20	75W	•	15"	4 ¼"	•	3000K	1,440*	90	Damp
62-986R1	Flush – White Fabric	Natural Brass	LED	20	75W	•	15"	4 ¼"	•	3000K	1,440*	90	Damp
62-987R1	Flush – White Fabric	Natural Brass	LED	20	75W	•	15"	4 ¼"	•	3000K	1,440*	90	Damp
62-988R1	Flush – White Fabric	Polished Nickel	LED	20	75W	•	15"	4 ¼"	•	3000K	1,440*	90	Damp
62-989R1	Flush – White Fabric	Polished Nickel	LED	20	75W	•	15"	4 ¼"	•	3000K	1,440*	90	Damp
62-990R1	Flush – White Fabric	•	LED	20	75W	•	15"	4 ¼"	•	3000K	1,440*	90	Damp

*Lumens measured at LED source.



62-989R1



62-988R1



62-990R1

EMR FLUSH LED

Emergency battery back-up ready flush mount fixtures
in Polished Nickel, Brushed Nickel or Aged Bronze



62-975



62-971



62-972



62-976



62-977



62-981



62-978



62-982

Item#	Description	Finish	Light Source	Watts	Incand. Equiv.	Length	Width	Height	Ext.	CCT	Lumens	CRI	Cert. Type
62-971	EMR Flush – Battery back-up ready	Brushed Nickel	LED	20	100W	•	15"	4"	•	3000K	1,660*	90	Damp†
62-972	EMR Flush – Battery back-up ready	Aged Bronze	LED	20	100W	•	15"	4"	•	3000K	1,660*	90	Damp†
62-975	EMR Flush – Battery back-up ready	Polished Nickel	LED	20	100W	•	14"	4 5/8"	•	3000K	1,660*	90	Damp†
62-976	EMR Flush – Battery back-up ready	Aged Bronze	LED	20	100W	•	14"	4 5/8"	•	3000K	1,660*	90	Damp†
62-977	EMR Flush – Battery back-up ready	Brushed Nickel	LED	20	100W	•	14"	5 3/8"	•	3000K	1,660*	90	Damp†
62-978	EMR Flush – Battery back-up ready	Aged Bronze	LED	20	100W	•	14"	5 3/8"	•	3000K	1,660*	90	Damp†
62-981	EMR Flush – Battery back-up ready	Polished Nickel	LED	20	100W	•	15"	4 1/2"	•	3000K	1,660*	90	Damp†
62-982	EMR Flush – Battery back-up ready	Aged Bronze	LED	20	100W	•	15"	4 1/2"	•	3000K	1,660*	90	Damp†

*Lumens measured at LED source. **Dimmable at 120V only.
†Not suitable for damp location if used with optional battery backup disk.

The emergency battery back-up disk, Satco model S9299 (120V) or Satco model S9780 (277V) (not included), easily mounts inside the pan of these fixtures instantly making them emergency lighting compliant. Battery back-up disk includes both the test button and indicator light. Batteries are easily accessible and included.

- Rechargeable batteries
- 90 minute run time



Remove the logo plate to mount the battery back-up indicator light and test button (included with battery back-up disk, sold separately).

Battery back-up disk (sold separately)



S9299 - 120V Battery back-up disk
S9780 - 277V Battery back-up disk

Replacement battery -
26F18650 2600 mAh, 5.2A



- Test Button - System checks on the battery power & circuit connections
- Indicator
 - Red: Battery charging
 - Green: Battery fully charged
 - Yellow: Check system
 - Off: Power outage, battery pack running

Project and
Functional Lighting.





CHANDELIERS



Dupont Nine Light Chandelier

(9) 60W A19 max. / Medium Base

Dimensions: Width 27 1/2", Height 23 1/2", Chain 72", Wire 12'

60-1823 Brushed Nickel / Satin White Glass

Accessories:

25-1069 3' Section of matching chain



Dupont Five Light Chandelier

(5) 60W A19 max. / Medium Base

Dimensions: Width 22", Height 15 3/4", Chain 48", Wire 12'

60-1822 Brushed Nickel / Satin White Glass

Convertible – Arms up or Down

Accessories:

25-1069 3' Section of matching chain



Dupont Three Light Chandelier

(3) 60W A19 max. / Medium Base

Dimensions: Width 17", Height 13 1/2", Chain 48", Wire 12'

60-1821 Brushed Nickel / Satin White Glass

Convertible – Arms up or Down

Accessories:

25-1069 3' Section of matching chain



Dupont Nine Light Chandelier

(9) 60W A19 max. / Medium Base

Dimensions: Width 27 1/2", Height 23 1/2", Chain 72", Wire 12'

60-1843 Dark Chocolate Bronze / Satin White Glass

Accessories:

25-3024 3' Section of matching chain



Dupont Five Light Chandelier

(5) 60W A19 max. / Medium Base

Dimensions: Width 22", Height 15 3/4", Chain 48", Wire 12'

60-1842 Dark Chocolate Bronze / Satin White Glass

Convertible – Arms up or Down

Accessories:

25-3024 3' Section of matching chain



Dupont Three Light Chandelier

(3) 60W A19 max. / Medium Base

Dimensions: Width 17", Height 13 1/2", Chain 48", Wire 12'

60-1841 Dark Chocolate Bronze / Satin White Glass

Convertible – Arms up or Down

Accessories:

25-3024 3' Section of matching chain

CHANDELIERS



Empire Nine Light Chandelier

(9) 60W A19 max. / Medium Base
Dimensions: Width 32", Height 18", Chain 72", Wire 12'
60-362 Old Bronze / Alabaster Glass
Accessories:
25-1067 3' Section of matching chain



Empire Six Light Chandelier

(6) 60W A19 max. / Medium Base
Dimensions: Width 26", Height 14", Chain 48", Wire 12'
60-358 Old Bronze / Alabaster Glass
Accessories:
25-1067 3' Section of matching chain



Empire Six Light Chandelier

(6) 60W A19 max. / Medium Base
Dimensions: Width 26", Height 14", Chain 48", Wire 12'
60-3169 Mahogany Bronze / Frosted Glass
Accessories:
25-2081 3' Section of matching chain



Empire Nine Light Chandelier

(9) 60W A19 max. / Medium Base
Dimensions: Width 32", Height 18", Chain 72", Wire 12'
60-3171 Mahogany Bronze / Frosted Glass
Accessories:
25-2081 3' Section of matching chain



Empire Six Light Chandelier

(6) 60W A19 max. / Medium Base
Dimensions: Width 26", Height 14", Chain 48", Wire 12'
60-1274 Mahogany Bronze / Champagne Glass
Accessories:
25-2081 3' Section of matching chain



Empire Nine Light Chandelier

(9) 60W A19 max. / Medium Base
Dimensions: Width 32", Height 18", Chain 72", Wire 12'
60-360 Brushed Nickel / Alabaster Glass
Accessories:
25-1069 3' Section of matching chain



Empire Six Light Chandelier

(6) 60W A19 max. / Medium Base
Dimensions: Width 26", Height 14", Chain 48", Wire 12'
60-356 Brushed Nickel / Alabaster Glass
Accessories:
25-1069 3' Section of matching chain



Empire Six Light Chandelier

(6) 60W A19 max. / Medium Base
Dimensions: Width 26", Height 14", Chain 48", Wire 12'
60-3255 Brushed Nickel / Frosted Glass
Accessories:
25-1069 3' Section of matching chain



Empire Nine Light Chandelier

(9) 60W A19 max. / Medium Base
Dimensions: Width 32", Height 18", Chain 72", Wire 12'
60-3256 Brushed Nickel / Frosted Glass
Accessories:
25-1069 3' Section of matching chain

CHANDELIERS



Empire Six Light Chandelier

(6) 60W A19 max. / Medium Base

Dimensions: Width 26", Height 14", Chain 48", Wire 12'

60-357 Polished Brass / Alabaster Glass

Accessories:

25-1066 3' Section of matching chain



Empire Six Light Chandelier

(6) 60W A19 max. / Medium Base

Dimensions: Width 26", Height 14", Chain 48", Wire 12'

60-359 Textured White / Alabaster Glass

Accessories:

25-1072 3' Section of matching chain



Gotham Five Light Chandelier

(5) 60W A19 max. / Medium Base

Dimensions: Width 24½", Height 17½", Chain 48", Wire 12'

60-189 Brushed Nickel / Alabaster Glass

Accessories:

25-1069 3' Section of matching chain



Gotham Three Light Chandelier

(3) 60W A19 max. / Medium Base

Dimensions: Width 22½", Height 17½", Chain 48", Wire 12'

60-190 Brushed Nickel / Alabaster Glass

Accessories:

25-1069 3' Section of matching chain



Gotham Five Light Chandelier

(5) 60W A19 max. / Medium Base

Dimensions: Width 24½", Height 17½", Chain 48", Wire 12'

60-3242 Brushed Nickel / Frosted Glass

Accessories:

25-1069 3' Section of matching chain



Gotham Three Light Chandelier

(3) 60W A19 max. / Medium Base

Dimensions: Width 22½", Height 17½", Chain 48", Wire 12'

60-3243 Brushed Nickel / Frosted Glass

Accessories:

25-1069 3' Section of matching chain



Gotham Five Light Chandelier

(5) 60W A19 max. / Medium Base
Dimensions: Width 24½", Height 17½", Chain 48", Wire 12'
60-191 Old Bronze / Alabaster Glass
Accessories:
25-1067 3' Section of matching chain



Gotham Three Light Chandelier

(3) 60W A19 max. / Medium Base
Dimensions: Width 22½", Height 17½", Chain 48", Wire 12'
60-192 Old Bronze / Alabaster Glass
Accessories:
25-1067 3' Section of matching chain



Gotham Five Light Chandelier

(5) 60W A19 max. / Medium Base
Dimensions: Width 24½", Height 17½", Chain 48", Wire 12'
60-3143 Mahogany Bronze / Frosted Glass
Accessories:
25-2081 3' Section of matching chain



Gotham Three Light Chandelier

(3) 60W A19 max. / Medium Base
Dimensions: Width 22½", Height 17½", Chain 48", Wire 12'
60-3144 Mahogany Bronze / Frosted Glass
Accessories:
25-2081 3' Section of matching chain



Ballerina Five Light Chandelier

(5) 60W A19 max. / Medium Base
Dimensions: Width 24", Height 18", Chain 48", Wire 12'
60-181 Brushed Nickel / Alabaster Glass
Accessories:
25-1069 3' Section of matching chain



Ballerina Three Light Chandelier

(3) 60W A19 max. / Medium Base
Dimensions: Width 20", Height 17", Chain 48", Wire 12'
60-182 Brushed Nickel / Alabaster Glass
Accessories:
25-1069 3' Section of matching chain

CHANDELIERS



Ballerina Five Light Chandelier

(5) 60W A19 max. / Medium Base
Dimensions: Width 24", Height 18", Chain 48", Wire 12'
60-3240 Brushed Nickel / Frosted Glass
Accessories:
25-1069 3' Section of matching chain



Ballerina Three Light Chandelier

(3) 60W A19 max. / Medium Base
Dimensions: Width 20", Height 17", Chain 48", Wire 12'
60-3241 Brushed Nickel / Frosted Glass
Accessories:
25-1069 3' Section of matching chain



Ballerina Five Light Chandelier

(5) 60W A19 max. / Medium Base
Dimensions: Width 24", Height 18", Chain 48", Wire 12'
60-183 Old Bronze / Alabaster Glass
Accessories:
25-1067 3' Section of matching chain



Ballerina Three Light Chandelier

(3) 60W A19 max. / Medium Base
Dimensions: Width 20", Height 17", Chain 48", Wire 12'
60-184 Old Bronze / Alabaster Glass
Accessories:
25-1067 3' Section of matching chain



Ballerina Five Light Chandelier

(5) 60W A19 max. / Medium Base
Dimensions: Width 24", Height 18", Chain 48", Wire 12'
60-3141 Mahogany Bronze / Frosted Glass
Accessories:
25-2081 3' Section of matching chain



Ballerina Three Light Chandelier

(3) 60W A19 max. / Medium Base
Dimensions: Width 20", Height 17", Chain 48", Wire 12'
60-3142 Mahogany Bronze / Frosted Glass
Accessories:
25-2081 3' Section of matching chain



Ballerina Five Light Chandelier

(5) 60W A19 max. / Medium Base
Dimensions: Width 24", Height 18", Chain 48", Wire 12'
60-1251 Mahogany Bronze / Champagne Glass
Accessories:
25-2081 3' Section of matching chain



Ballerina Three Light Chandelier

(3) 60W A19 max. / Medium Base
Dimensions: Width 20", Height 17", Chain 48", Wire 12'
60-1252 Mahogany Bronze / Champagne Glass
Accessories:
25-2081 3' Section of matching chain



Ballerina Five Light Chandelier

(5) 60W A19 max. / Medium Base
Dimensions: Width 24", Height 18", Chain 48", Wire 12'
60-185 Polished Brass / Alabaster Glass
Accessories:
25-1066 3' Section of matching chain



Ballerina Three Light Chandelier

(3) 60W A19 max. / Medium Base
Dimensions: Width 20", Height 17", Chain 48", Wire 12'
60-186 Polished Brass / Alabaster Glass
Accessories:
25-1066 3' Section of matching chain



Ballerina Five Light Chandelier

(5) 60W A19 max. / Medium Base
Dimensions: Width 24", Height 18", Chain 48", Wire 12'
60-187 Textured White / Alabaster Glass
Accessories:
25-1072 3' Section of matching chain



Ballerina Three Light Chandelier

(3) 60W A19 max. / Medium Base
Dimensions: Width 20", Height 17", Chain 48", Wire 12'
60-188 Textured White / Alabaster Glass
Accessories:
25-1072 3' Section of matching chain

CHANDELIERS



Five Light Chandelier

(5) 60W A19 max. / Medium Base

Dimensions: Width 22", Height 18", Chain 36", Wire 12'

76-695 Brushed Nickel / Frosted Ribbed Glass

Accessories:

25-1069 3' Section of Brushed Nickel chain



Five Light Chandelier

(5) 60W A19 max. / Medium Base

Dimensions: Width 22", Height 18", Chain 36", Wire 12'

76-444 Brushed Nickel / Clear Ribbed Glass

Accessories:

25-1069 3' Section of Brushed Nickel chain



Five Light Chandelier

(5) 60W A19 max. / Medium Base

Dimensions: Width 22", Height 18", Chain 36", Wire 12'

76-694 Old Bronze / Frosted Ribbed Glass

Accessories:

25-1067 3' Section of Old Bronze chain



Five Light Chandelier

(5) 60W A19 max. / Medium Base

Dimensions: Width 22", Height 18", Chain 36", Wire 12'

76-445 Old Bronze / Clear Ribbed Glass

Accessories:

25-1067 3' Section of Old Bronze chain



Five Light Chandelier

(5) 60W A19 max. / Medium Base

Dimensions: Width 22", Height 18", Chain 36", Wire 12'

76-693 Textured White / Frosted Ribbed Glass

Accessories:

25-1072 3' Section of Textured White chain



Five Light Chandelier

(5) 60W A19 max. / Medium Base

Dimensions: Width 23", Height 13 1/8", Chain 36", Wire 12'

60-1290 Brushed Nickel / Alabaster Glass

Accessories:

25-1069 3' Section of Brushed Nickel chain



Five Light Chandelier

(5) 60W A19 max. / Medium Base

Dimensions: Width 23", Height 13 1/8", Chain 36", Wire 12'

60-1291 Old Bronze / Alabaster Glass

Accessories:

25-1067 3' Section of Old Bronze chain



Five Light Chandelier

(5) 60W B Type max. / Candelabra Base

Dimensions: Width 18", Height 13", Chain 36", Wire 12'

60-1298 Brushed Nickel

Accessories:

25-1069 3' Section of Brushed Nickel chain



Five Light Chandelier

(5) 60W B Type max. / Candelabra Base

Dimensions: Width 18", Height 13", Chain 36", Wire 12'

76-280 Polished Brass

Accessories:

25-1066 3' Section of Polished Brass chain

CLOSE-TO-CEILING



15" Semi-Flush Convertible to Pendant
(3) 60W A19 max. / Medium Base
Dimensions: Width 15 1/4", Height 15 1/2", Wire 12'
60-202 Brushed Nickel / Alabaster Glass
Accessories:
25-1403 Pendant conversion kit
25-1069 3' Section of matching chain



15" Semi-Flush Convertible to Pendant
(3) 60W A19 max. / Medium Base
Dimensions: Width 15 1/4", Height 15 1/2", Wire 12'
60-3246 Brushed Nickel / Frosted Glass
Accessories:
25-1403 Pendant conversion kit
25-1069 3' Section of matching chain



13" Semi-Flush Convertible to Pendant
(2) 60W A19 max. / Medium Base
Dimensions: Width 13 1/4", Height 14", Wire 12'
60-201 Brushed Nickel / Alabaster Glass
Accessories:
25-1403 Pendant conversion kit
25-1069 3' Section of matching chain



13" Semi-Flush Convertible to Pendant
(2) 60W A19 max. / Medium Base
Dimensions: Width 13 1/4", Height 14", Wire 12'
60-3245 Brushed Nickel / Frosted Glass
Accessories:
25-1403 Pendant conversion kit
25-1069 3' Section of matching chain



11" Semi-Flush Convertible to Pendant
(2) 60W A19 max. / Medium Base
Dimensions: Width 11 3/8", Height 12", Wire 12'
60-200 Brushed Nickel / Alabaster Glass
Accessories:
25-1403 Pendant conversion kit
25-1069 3' Section of matching chain



11" Semi-Flush Convertible to Pendant
(2) 60W A19 max. / Medium Base
Dimensions: Width 11 3/8", Height 12", Wire 12'
60-3244 Brushed Nickel / Frosted Glass
Accessories:
25-1403 Pendant conversion kit
25-1069 3' Section of matching chain



15" Semi-Flush Convertible to Pendant

(3) 60W A19 max. / Medium Base

Dimensions: Width 15 1/4", Height 15 1/2", Wire 12'

60-210 Old Bronze / Alabaster Glass

Accessories:

25-1402 Pendant conversion kit

25-1067 3' Section of matching chain



15" Semi-Flush Convertible to Pendant

(3) 60W A19 max. / Medium Base

Dimensions: Width 15 1/4", Height 15 1/2", Wire 12'

60-3151 Mahogany Bronze / Frosted Glass

Accessories:

25-2082 Pendant conversion kit

25-2081 3' Section of matching chain



13" Semi-Flush Convertible to Pendant

(2) 60W A19 max. / Medium Base

Dimensions: Width 13 1/4", Height 14", Wire 12'

60-209 Old Bronze / Alabaster Glass

Accessories:

25-1402 Pendant conversion kit

25-1067 3' Section of matching chain



13" Semi-Flush Convertible to Pendant

(2) 60W A19 max. / Medium Base

Dimensions: Width 13 1/4", Height 14", Wire 12'

60-3149 Mahogany Bronze / Frosted Glass

Accessories:

25-2082 Pendant conversion kit

25-2081 3' Section of matching chain



11" Semi-Flush Convertible to Pendant

(2) 60W A19 max. / Medium Base

Dimensions: Width 11 3/8", Height 12", Wire 12'

60-208 Old Bronze / Alabaster Glass

Accessories:

25-1402 Pendant conversion kit

25-1067 3' Section of matching chain



11" Semi-Flush Convertible to Pendant

(2) 60W A19 max. / Medium Base

Dimensions: Width 11 3/8", Height 12", Wire 12'

60-3148 Mahogany Bronze / Frosted Glass

Accessories:

25-2082 Pendant conversion kit

25-2081 3' Section of matching chain

CLOSE-TO-CEILING



Dupont Semi-Flush Dome

(3) 60W A19 max. / Medium Base
Dimensions: Width 16", Height 15 1/2", Wire 12'
60-1827 Brushed Nickel / Satin White Glass
Convertible to pendant
Accessories:
25-1403 Pendant conversion kit
25-1069 3' Section of matching chain



Dupont Semi-Flush Dome

(3) 60W A19 max. / Medium Base
Dimensions: Width 16", Height 15 1/2", Wire 12'
60-1847 Dark Chocolate Bronze / Satin White Glass
Convertible to pendant
Accessories:
25-3073 Pendant conversion kit
25-3024 3' Section of matching chain



Neval Flush

(2) 60W A19 max. / Medium Base
Dimensions: Width 13", Height 5 1/4"
60-5486 Brushed Nickel / Satin White Glass



Neval Flush

(2) 60W A19 max. / Medium Base
Dimensions: Width 13", Height 5 1/4"
60-5586 Sudbury Bronze / Satin White Glass



Dupont Large Flush Dome

(2) 75W A19 max. / Medium Base

Dimensions: Width 15", Height 7³/₄"

60-1826 Brushed Nickel / Satin White Glass

CUL damp location



Dupont Large Flush Dome

(2) 75W A19 max. / Medium Base

Dimensions: Width 15", Height 7³/₄"

60-1846 Dark Chocolate Bronze / Satin White Glass

CUL damp location



Dupont Medium Flush Dome

(2) 60W A19 max. / Medium Base

Dimensions: Width 13", Height 7"

60-1825 Brushed Nickel / Satin White Glass

CUL damp location



Dupont Medium Flush Dome

(2) 60W A19 max. / Medium Base

Dimensions: Width 13", Height 7"

60-1845 Dark Chocolate Bronze / Satin White Glass

CUL damp location



Dupont Small Flush Dome

(1) 100W A19 max. / Medium Base

Dimensions: Width 11", Height 7"

60-1824 Brushed Nickel / Satin White Glass

CUL damp location



Dupont Small Flush Dome

(1) 100W A19 max. / Medium Base

Dimensions: Width 11", Height 7"

60-1844 Dark Chocolate Bronze / Satin White Glass

CUL damp location

CLOSE-TO-CEILING



15" Flush Dome

(3) 60W A19 max. / Medium Base

Dimensions: Width 15 1/4", Height 6"

60-199 Brushed Nickel / Alabaster Glass

CUL damp location



17" Twist and Lock

(3) 60W A19 max. / Medium Base

Dimensions: Width 17", Height 6"

60-285 Brushed Nickel / Alabaster Glass

CUL damp location



13" Flush Dome

(2) 60W A19 max. / Medium Base

Dimensions: Width 13 1/4", Height 5 3/8"

60-198 Brushed Nickel / Alabaster Glass

CUL damp location



14" Twist and Lock

(2) 60W A19 max. / Medium Base

Dimensions: Width 14", Height 5 1/2"

60-284 Brushed Nickel / Alabaster Glass

CUL damp location



11" Flush Dome

(2) 60W A19 max. / Medium Base

Dimensions: Width 11 3/8", Height 4 7/8"

60-197 Brushed Nickel / Alabaster Glass

CUL damp location



12" Twist and Lock

(1) 60W A19 max. / Medium Base

Dimensions: Width 11 1/2", Height 4 1/2"

60-283 Brushed Nickel / Alabaster Glass

CUL damp location



15" Flush Dome

(3) 60W A19 max. / Medium Base

Dimensions: Width 15 1/4", Height 6"

60-3263 Brushed Nickel / Frosted Glass

CUL damp location



17" Twist and Lock

(3) 60W A19 max. / Medium Base

Dimensions: Width 17", Height 6"

60-3273 Brushed Nickel / Frosted Glass

CUL damp location



13" Flush Dome

(2) 60W A19 max. / Medium Base

Dimensions: Width 13 1/4", Height 5 3/8"

60-3262 Brushed Nickel / Frosted Glass

CUL damp location



14" Twist and Lock

(2) 60W A19 max. / Medium Base

Dimensions: Width 14", Height 5 1/2"

60-3272 Brushed Nickel / Frosted Glass

CUL damp location



11" Flush Dome

(2) 60W A19 max. / Medium Base

Dimensions: Width 11 3/8", Height 4 7/8"

60-3261 Brushed Nickel / Frosted Glass

CUL damp location



12" Twist and Lock

(1) 60W A19 max. / Medium Base

Dimensions: Width 11 1/2", Height 4 1/2"

60-3271 Brushed Nickel / Frosted Glass

CUL damp location

CLOSE-TO-CEILING



15" Flush Dome

(3) 60W A19 max. / Medium Base
Dimensions: Width 15 1/4", Height 6"
60-207 Old Bronze / Alabaster Glass
CUL damp location



17" Twist and Lock

(3) 60W A19 max. / Medium Base
Dimensions: Width 17", Height 6"
60-282 Old Bronze / Alabaster Glass
CUL damp location



13" Flush Dome

(2) 60W A19 max. / Medium Base
Dimensions: Width 13 1/4", Height 5 3/8"
60-206 Old Bronze / Alabaster Glass
CUL damp location



14" Twist and Lock

(2) 60W A19 max. / Medium Base
Dimensions: Width 14", Height 5 1/2"
60-281 Old Bronze / Alabaster Glass
CUL damp location



11" Flush Dome

(2) 60W A19 max. / Medium Base
Dimensions: Width 11 3/8", Height 4 7/8"
60-205 Old Bronze / Alabaster Glass
CUL damp location



12" Twist and Lock

(1) 60W A19 max. / Medium Base
Dimensions: Width 11 1/2", Height 4 1/2"
60-280 Old Bronze / Alabaster Glass
CUL damp location



15" Flush Dome

(3) 60W A19 max. / Medium Base

Dimensions: Width 15 1/4", Height 6"

60-3147 Mahogany Bronze / Frosted Glass

CUL damp location



17" Twist and Lock

(3) 60W A19 max. / Medium Base

Dimensions: Width 17", Height 6"

60-3177 Mahogany Bronze / Frosted Glass

CUL damp location



13" Flush Dome

(2) 60W A19 max. / Medium Base

Dimensions: Width 13 1/4", Height 5 3/8"

60-3146 Mahogany Bronze / Frosted Glass

CUL damp location



14" Twist and Lock

(2) 60W A19 max. / Medium Base

Dimensions: Width 14", Height 5 1/2"

60-3176 Mahogany Bronze / Frosted Glass

CUL damp location



11" Flush Dome

(2) 60W A19 max. / Medium Base

Dimensions: Width 11 3/8", Height 4 7/8"

60-3145 Mahogany Bronze / Frosted Glass

CUL damp location



12" Twist and Lock

(1) 60W A19 max. / Medium Base

Dimensions: Width 11 1/2", Height 4 1/2"

60-3175 Mahogany Bronze / Frosted Glass

CUL damp location

CLOSE-TO-CEILING



15" Flush Dome

(3) 60W A19 max. / Medium Base

Dimensions: Width 15 1/4", Height 6"

60-1257 Mahogany Bronze / Champagne Glass

CUL damp location



15" Flush Dome

(3) 60W A19 max. / Medium Base

Dimensions: Width 15 1/4", Height 6"

60-215 Polished Brass / Alabaster Glass

CUL damp location



13" Flush Dome

(2) 60W A19 max. / Medium Base

Dimensions: Width 13 1/4", Height 5 3/8"

60-1256 Mahogany Bronze / Champagne Glass

CUL damp location



13" Flush Dome

(2) 60W A19 max. / Medium Base

Dimensions: Width 13 1/4", Height 5 3/8"

60-214 Polished Brass / Alabaster Glass

CUL damp location



11" Flush Dome

(2) 60W A19 max. / Medium Base

Dimensions: Width 11 3/8", Height 4 7/8"

60-1255 Mahogany Bronze / Champagne Glass

CUL damp location



11" Flush Dome

(2) 60W A19 max. / Medium Base

Dimensions: Width 11 3/8", Height 4 7/8"

60-213 Polished Brass / Alabaster Glass

CUL damp location



15" Flush Dome

(3) 60W A19 max. / Medium Base

Dimensions: Width 15 1/4", Height 6"

60-223 Textured White / Alabaster Glass

CUL damp location



15" Flush Dome

(3) 60W A19 max. / Medium Base

Dimensions: Width 15 1/4", Height 6"

76-026 Polished Brass / Clear Swirl Glass

CUL damp location



13" Flush Dome

(2) 60W A19 max. / Medium Base

Dimensions: Width 13 1/4", Height 5 3/8"

60-222 Textured White / Alabaster Glass

CUL damp location



13" Flush Dome

(2) 60W A19 max. / Medium Base

Dimensions: Width 13 1/4", Height 5 1/2"

76-025 Polished Brass / Clear Swirl Glass

CUL damp location



11" Flush Dome

(2) 60W A19 max. / Medium Base

Dimensions: Width 11 3/8", Height 4 7/8"

60-221 Textured White / Alabaster Glass

CUL damp location



11" Flush Dome

(2) 60W A19 max. / Medium Base

Dimensions: Width 11 1/4", Height 5"

76-024 Polished Brass / Clear Swirl Glass

CUL damp location

CLOSE-TO-CEILING



15" Flush Dome

(3) 60W A19 max. / Medium Base

Dimensions: Width 15 1/4", Height 6"

76-245 Brushed Nickel / Frosted Melon Glass

CUL damp location



15" Flush Dome

(3) 60W A19 max. / Medium Base

Dimensions: Width 15 1/4", Height 6"

76-248 Old Bronze / Frosted Melon Glass

CUL damp location



13" Flush Dome

(2) 60W A19 max. / Medium Base

Dimensions: Width 13 1/4", Height 5 1/2"

76-244 Brushed Nickel / Frosted Melon Glass

CUL damp location



13" Flush Dome

(2) 60W A19 max. / Medium Base

Dimensions: Width 13 1/4", Height 5 1/2"

76-247 Old Bronze / Frosted Melon Glass

CUL damp location



11" Flush Dome

(2) 60W A19 max. / Medium Base

Dimensions: Width 11 1/4", Height 5"

76-243 Brushed Nickel / Frosted Melon Glass

CUL damp location



11" Flush Dome

(2) 60W A19 max. / Medium Base

Dimensions: Width 11 1/4", Height 5"

76-246 Old Bronze / Frosted Melon Glass

CUL damp location



15" Flush Dome

(3) 60W A19 max. / Medium Base
Dimensions: Width 15 1/4", Height 6"
76-128 Polished Brass / Frosted Melon Glass
CUL damp location



15" Flush Dome

(3) 60W A19 max. / Medium Base
Dimensions: Width 15 1/4", Height 6"
76-129 Textured White / Frosted Melon Glass
CUL damp location



13" Flush Dome

(2) 60W A19 max. / Medium Base
Dimensions: Width 13 1/4", Height 5 1/2"
76-126 Polished Brass / Frosted Melon Glass
CUL damp location



13" Flush Dome

(2) 60W A19 max. / Medium Base
Dimensions: Width 13 1/4", Height 5 1/2"
76-127 Textured White / Frosted Melon Glass
CUL damp location



11" Flush Dome

(2) 60W A19 max. / Medium Base
Dimensions: Width 11 1/4", Height 5"
76-124 Polished Brass / Frosted Melon Glass
CUL damp location



11" Flush Dome

(2) 60W A19 max. / Medium Base
Dimensions: Width 11 1/4", Height 5"
76-125 Textured White / Frosted Melon Glass
CUL damp location

CLOSE-TO-CEILING



15" Flush Dome

(3) 60W A19 max. / Medium Base

Dimensions: Width 15 1/4", Height 6"

76-611 Brushed Nickel / Clear Ribbed Glass

CUL damp location



15" Flush Dome

(3) 60W A19 max. / Medium Base

Dimensions: Width 15 1/4", Height 6"

76-608 Old Bronze / Clear Ribbed Glass

CUL damp location



13" Flush Dome

(2) 60W A19 max. / Medium Base

Dimensions: Width 13 1/4", Height 5 1/2"

76-610 Brushed Nickel / Clear Ribbed Glass

CUL damp location



13" Flush Dome

(2) 60W A19 max. / Medium Base

Dimensions: Width 13 1/4", Height 5 1/2"

76-607 Old Bronze / Clear Ribbed Glass

CUL damp location



11" Flush Dome

(2) 60W A19 max. / Medium Base

Dimensions: Width 11 1/4", Height 5"

76-609 Brushed Nickel / Clear Ribbed Glass

CUL damp location



11" Flush Dome

(2) 60W A19 max. / Medium Base

Dimensions: Width 11 1/4", Height 5"

76-606 Old Bronze / Clear Ribbed Glass

CUL damp location



15" Flush Dome

(3) 60W A19 max. / Medium Base

Dimensions: Width 15 1/4", Height 6"

76-093 Polished Brass / Clear Ribbed Glass

CUL damp location



15" Flush Dome

(3) 60W A19 max. / Medium Base

Dimensions: Width 15 1/4", Height 6"

76-193 Textured White / Clear Ribbed Glass

CUL damp location



13" Flush Dome

(2) 60W A19 max. / Medium Base

Dimensions: Width 13 1/4", Height 5 1/2"

76-092 Polished Brass / Clear Ribbed Glass

CUL damp location



13" Flush Dome

(2) 60W A19 max. / Medium Base

Dimensions: Width 13 1/4", Height 5 1/2"

76-192 Textured White / Clear Ribbed Glass

CUL damp location



11" Flush Dome

(2) 60W A19 max. / Medium Base

Dimensions: Width 11 1/4", Height 5"

76-091 Polished Brass / Clear Ribbed Glass

CUL damp location



11" Flush Dome

(2) 60W A19 max. / Medium Base

Dimensions: Width 11 1/4", Height 5"

76-191 Textured White / Clear Ribbed Glass

CUL damp location

CLOSE-TO-CEILING



15" Flush Dome

(3) 60W A19 max. / Medium Base

Dimensions: Width 15 1/4", Height 6"

76-135 Textured White / Frosted Ribbed Glass

CUL damp location



13" Flush Dome

(2) 60W A19 max. / Medium Base

Dimensions: Width 13 1/4", Height 5 1/2"

76-133 Textured White / Frosted Ribbed Glass

CUL damp location



11" Flush Dome

(2) 60W A19 max. / Medium Base

Dimensions: Width 11 1/4", Height 5"

76-131 Textured White / Frosted Ribbed Glass

CUL damp location



15" Flush Dome

(3) 60W A19 max. / Medium Base

Dimensions: Width 15 1/4", Height 6"

76-134 Polished Brass / Frosted Ribbed Glass

CUL damp location



13" Flush Dome

(2) 60W A19 max. / Medium Base

Dimensions: Width 13 1/4", Height 5 1/2"

76-132 Polished Brass / Frosted Ribbed Glass

CUL damp location



11" Flush Dome

(2) 60W A19 max. / Medium Base

Dimensions: Width 11 1/4", Height 5"

76-130 Polished Brass / Frosted Ribbed Glass

CUL damp location

CLOSE-TO-CEILING



16" Tri-Clip Flush Dome
(2) 60W A19 max. / Medium Base
Dimensions: Width 16 1/8", Height 5"
60-271 Brushed Nickel / Alabaster Glass
CUL damp location



16" Tri-Clip Flush Dome
(2) 60W A19 max. / Medium Base
Dimensions: Width 16 1/8", Height 5"
60-273 Old Bronze / Alabaster Glass
CUL damp location



12" Tri-Clip Flush Dome
(1) 60W A19 max. / Medium Base
Dimensions: Width 12 1/2", Height 4"
60-270 Brushed Nickel / Alabaster Glass
CUL damp location



12" Tri-Clip Flush Dome
(1) 60W A19 max. / Medium Base
Dimensions: Width 12 1/2", Height 4"
60-272 Old Bronze / Alabaster Glass
CUL damp location



6" Flush Ball
(1) 60W A19 max. / Medium Base
Dimensions: Width 6", Height 7 1/4"
60-257 Brushed Nickel / Alabaster Glass
CUL damp location



6" Flush Ball
(1) 60W A19 max. / Medium Base
Dimensions: Width 6", Height 7 1/4"
60-259 Old Bronze / Alabaster Glass
CUL damp location



16" Tri-Clip Flush Dome

(2) 60W A19 max. / Medium Base

Dimensions: Width 16 1/8", Height 5"

60-275 Polished Brass / Alabaster Glass



16" Tri-Clip Flush Dome

(2) 60W A19 max. / Medium Base

Dimensions: Width 16 1/8", Height 5"

60-277 Textured White / Alabaster Glass



12" Tri-Clip Flush Dome

(1) 60W A19 max. / Medium Base

Dimensions: Width 12 1/2", Height 4"

60-274 Polished Brass / Alabaster Glass



12" Tri-Clip Flush Dome

(1) 60W A19 max. / Medium Base

Dimensions: Width 12 1/2", Height 4"

60-276 Textured White / Alabaster Glass



6" Flush Ball

(1) 60W A19 max. / Medium Base

Dimensions: Width 6", Height 7 1/4"

60-255 Polished Brass / Alabaster Glass

CUL damp location



6" Flush Ball

(1) 60W A19 max. / Medium Base

Dimensions: Width 6", Height 7 1/4"

60-1279 Mahogany Bronze / Champagne Glass

CUL damp location

CLOSE-TO-CEILING



Large Mushroom
(2) 60W A19 max. / Medium Base
Dimensions: Width 12", Height 6"
77-986 Polished Brass / White Glass
CUL damp location



Large Mushroom
(2) 60W A19 max. / Medium Base
Dimensions: Width 12", Height 6"
77-987 White / White Glass
CUL damp location



Medium Mushroom
(2) 60W A19 max. / Medium Base
Dimensions: Width 9½", Height 6"
77-061 Polished Brass / White Glass
CUL damp location



Medium Mushroom
(2) 60W A19 max. / Medium Base
Dimensions: Width 9½", Height 6"
77-062 White / White Glass
CUL damp location



Small Mushroom
(1) 60W A19 max. / Medium Base
Dimensions: Width 7½", Height 5"
77-059 Polished Brass / White Glass
CUL damp location



Small Mushroom
(1) 60W A19 max. / Medium Base
Dimensions: Width 7½", Height 5"
77-060 White / White Glass
CUL damp location



Large Mushroom

(2) 60W A19 max. / Medium Base

Dimensions: Width 12", Height 6"

77-347 Polished Chrome / White Glass

CUL damp location



Large Mushroom

(2) 60W A19 max. / Medium Base

Dimensions: Width 12", Height 6"

76-604 Old Bronze / White Glass

CUL damp location



Medium Mushroom

(2) 60W A19 max. / Medium Base

Dimensions: Width 9½", Height 6"

77-346 Polished Chrome / White Glass

CUL damp location



Medium Mushroom

(2) 60W A19 max. / Medium Base

Dimensions: Width 9½", Height 6"

76-602 Old Bronze / White Glass

CUL damp location



Small Mushroom

(1) 60W A19 max. / Medium Base

Dimensions: Width 7½", Height 5"

77-345 Polished Chrome / White Glass

CUL damp location



Small Mushroom

(1) 60W A19 max. / Medium Base

Dimensions: Width 7½", Height 5"

76-600 Old Bronze / White Glass

CUL damp location

CLOSE-TO-CEILING



Large Mushroom
(2) 60W A19 max. / Medium Base
Dimensions: Width 12", Height 6"
76-605 Brushed Nickel / White Glass
CUL damp location



Large Mushroom
(2) 60W A19 max. / Medium Base
Dimensions: Width 12", Height 6"
77-988 Antique Brass / White Glass
CUL damp location



Medium Mushroom
(2) 60W A19 max. / Medium Base
Dimensions: Width 9½", Height 6"
76-603 Brushed Nickel / White Glass
CUL damp location



Medium Mushroom
(2) 60W A19 max. / Medium Base
Dimensions: Width 9½", Height 6"
77-924 Antique Brass / White Glass
CUL damp location



Small Mushroom
(1) 60W A19 max. / Medium Base
Dimensions: Width 7½", Height 5"
76-601 Brushed Nickel / White Glass
CUL damp location



Small Mushroom
(1) 60W A19 max. / Medium Base
Dimensions: Width 7½", Height 5"
77-921 Antique Brass / White Glass
CUL damp location



Large Mushroom

(2) 60W A19 max. / Medium Base

Dimensions: Width 12", Height 6"

76-614 Textured White / Alabaster Glass

CUL damp location



Large Mushroom

(2) 60W A19 max. / Medium Base

Dimensions: Width 12", Height 6"

76-678 Polished Brass / Alabaster Glass

CUL damp location



Medium Mushroom

(2) 60W A19 max. / Medium Base

Dimensions: Width 9½", Height 6"

76-613 Textured White / Alabaster Glass

CUL damp location



Medium Mushroom

(2) 60W A19 max. / Medium Base

Dimensions: Width 9½", Height 6"

76-675 Polished Brass / Alabaster Glass

CUL damp location



Small Mushroom

(1) 60W A19 max. / Medium Base

Dimensions: Width 7½", Height 5"

76-612 Textured White / Alabaster Glass

CUL damp location



Small Mushroom

(1) 60W A19 max. / Medium Base

Dimensions: Width 7½", Height 5"

76-672 Polished Brass / Alabaster Glass

CUL damp location

CLOSE-TO-CEILING



Large Mushroom
(2) 60W A19 max. / Medium Base
Dimensions: Width 12", Height 6"
76-676 Old Bronze / Alabaster Glass
CUL damp location



Large Mushroom
(2) 60W A19 max. / Medium Base
Dimensions: Width 12", Height 6"
76-677 Brushed Nickel / Alabaster Glass
CUL damp location



Medium Mushroom
(2) 60W A19 max. / Medium Base
Dimensions: Width 9½", Height 6"
76-673 Old Bronze / Alabaster Glass
CUL damp location



Medium Mushroom
(2) 60W A19 max. / Medium Base
Dimensions: Width 9½", Height 6"
76-674 Brushed Nickel / Alabaster Glass
CUL damp location



Small Mushroom
(1) 60W A19 max. / Medium Base
Dimensions: Width 7½", Height 5"
76-670 Old Bronze / Alabaster Glass
CUL damp location



Small Mushroom
(1) 60W A19 max. / Medium Base
Dimensions: Width 7½", Height 5"
76-671 Brushed Nickel / Alabaster Glass
CUL damp location



Large Mushroom

(2) 60W A19 max. / Medium Base

Dimensions: Width 12", Height 6"

60-2645 Mahogany Bronze / Frosted Glass
CUL damp location



Large Mushroom

(2) 60W A19 max. / Medium Base

Dimensions: Width 12", Height 6"

60-2646 Mahogany Bronze / Champagne Linen Glass
CUL damp location



Medium Mushroom

(2) 60W A19 max. / Medium Base

Dimensions: Width 9½", Height 6"

60-2643 Mahogany Bronze / Frosted Glass
CUL damp location



Medium Mushroom

(2) 60W A19 max. / Medium Base

Dimensions: Width 9½", Height 6"

60-2644 Mahogany Bronze / Champagne Linen Glass
CUL damp location



Small Mushroom

(1) 60W A19 max. / Medium Base

Dimensions: Width 7½", Height 5"

60-2641 Mahogany Bronze / Frosted Glass
CUL damp location



Small Mushroom

(1) 60W A19 max. / Medium Base

Dimensions: Width 7½", Height 5"

60-2642 Mahogany Bronze / Champagne Linen Glass
CUL damp location

CLOSE-TO-CEILING



Medium Mushroom
(2) 60W A19 max. / Medium Base
Dimensions: Width 9½", Height 6"
76-252 Polished Brass / Clear Ribbed Glass
CUL damp location



Medium Mushroom
(2) 60W A19 max. / Medium Base
Dimensions: Width 9½", Height 6"
76-253 White / Clear Ribbed Glass
CUL damp location



Small Mushroom
(1) 60W A19 max. / Medium Base
Dimensions: Width 7½", Height 5"
76-250 Polished Brass / Clear Ribbed Glass
CUL damp location



Small Mushroom
(1) 60W A19 max. / Medium Base
Dimensions: Width 7½", Height 5"
76-251 White / Clear Ribbed Glass
CUL damp location



6" Flush Ball
(1) 60W A19 max. / Medium Base
Dimensions: Width 6", Height 7¼"
76-256 Polished Brass / Clear Ribbed Glass
CUL damp location



6" Flush Ball
(1) 60W A19 max. / Medium Base
Dimensions: Width 6", Height 7¼"
76-257 White / Clear Ribbed Glass
CUL damp location



6" Flush Ball

(1) 60W A19 max. / Medium Base
Dimensions: Width 6", Height 7 1/4"

60-3249 Brushed Nickel / Frosted Glass
CUL damp location



6" Flush Ball

(1) 60W A19 max. / Medium Base
Dimensions: Width 6", Height 7 1/4"

77-108 Polished Brass / White Glass
CUL damp location



6" Flush Ball

(1) 60W A19 max. / Medium Base
Dimensions: Width 6", Height 7 1/4"

60-245 Brushed Nickel / White Glass
CUL damp location



6" Flush Ball

(1) 60W A19 max. / Medium Base
Dimensions: Width 6", Height 7 1/4"

77-110 Polished Chrome / White Glass
CUL damp location



6" Flush Ball

(1) 60W A19 max. / Medium Base
Dimensions: Width 6", Height 7 1/4"

60-247 Old Bronze / White Glass
CUL damp location



6" Flush Ball

(1) 60W A19 max. / Medium Base
Dimensions: Width 6", Height 7 1/4"

77-947 White / White Glass
CUL damp location

CLOSE-TO-CEILING



8" Flush Ball

(1) 60W A19 max. / Medium Base
Dimensions: Width 8", Height 9 1/4"
77-111 Polished Chrome / White Glass
CUL damp location



6" Flush Ball with Pull Chain Switch

(1) 60W A19 max. / Medium Base
Dimensions: Width 6", Height 7 1/4"
60-295 Polished Brass / White Glass
CUL damp location



8" Flush Ball

(1) 60W A19 max. / Medium Base
Dimensions: Width 8", Height 9 1/4"
77-109 Polished Brass / White Glass
CUL damp location



6" Flush Ball with Pull Chain Switch

(1) 60W A19 max. / Medium Base
Dimensions: Width 6", Height 7 1/4"
60-712 White / White Glass
CUL damp location



8" Flush Ball

(1) 60W A19 max. / Medium Base
Dimensions: Width 8", Height 9 1/4"
77-948 White / White Glass
CUL damp location



Clear Bottom Squat Ball

(1) 60W A19 max. / Medium Base
Dimensions: Width 5", Height 5 1/2"
77-122 Polished Brass / Frosted, Clear Bottom Glass
CUL damp location



Style Socket (ceiling or wall)

(1) 60W max. / Medium Base – LAMP NOT INCLUDED
Dimensions: Diameter 5", Extension 2 3/8" (less lamp)
60-4801 Brushed Nickel
CUL damp location



Style Socket (ceiling or wall)

(1) 60W max. / Medium Base – LAMP NOT INCLUDED
Dimensions: Diameter 5", Extension 2 3/8" (less lamp)
60-4802 Polished Nickel
CUL damp location



Style Socket (ceiling or wall)

(1) 60W max. / Medium Base – LAMP NOT INCLUDED
Dimensions: Diameter 5", Extension 2 3/8" (less lamp)
60-4803 White
CUL damp location



Style Socket (ceiling or wall)

(1) 60W max. / Medium Base – LAMP NOT INCLUDED
Dimensions: Diameter 5", Extension 2 3/8" (less lamp)
60-4804 Dark Bronze
CUL damp location



Clear Pineapple

(1) 60W A19 max. / Medium Base
Dimensions: Width 5", Height 5 1/2"
77-125 Polished Brass / Clear Pineapple Glass
CUL damp location



Small Frosted Grape Mushroom

(1) 60W A19 max. / Medium Base
Dimensions: Width 6", Height 5"
77-123 Polished Brass / Frosted Grape Glass
CUL damp location

CLOSE-TO-CEILING



Large Flush Drum
(2) 60W A19 max. / Medium Base
Dimensions: Width 10", Height 7"
77-102 Polished Chrome / Crystal & White Glass
CUL damp location



Large Flush Drum
(2) 60W A19 max. / Medium Base
Dimensions: Width 10", Height 7"
77-099 White / Crystal & White Glass
CUL damp location



Medium Flush Drum
(2) 60W A19 max. / Medium Base
Dimensions: Width 8", Height 6"
77-101 Polished Chrome / Crystal & White Glass
CUL damp location



Medium Flush Drum
(2) 60W A19 max. / Medium Base
Dimensions: Width 8", Height 6"
77-098 White / Crystal & White Glass
CUL damp location



Small Flush Drum
(1) 60W A19 max. / Medium Base
Dimensions: Width 6", Height 5"
77-100 Polished Chrome / Crystal & White Glass
CUL damp location



Small Flush Drum
(1) 60W A19 max. / Medium Base
Dimensions: Width 6", Height 5"
77-097 White / Crystal & White Glass
CUL damp location



Large Flush Drum

(2) 60W A19 max. / Medium Base
Dimensions: Width 10", Height 7"
77-344 Polished Chrome / White Glass
CUL damp location



Round Grape Design

(2) 60W A19 max. / Medium Base
Dimensions: Width 12", Height 4³/₄"
76-268 White Holder
CUL damp location



Medium Flush Drum

(2) 60W A19 max. / Medium Base
Dimensions: Width 8", Height 6"
77-343 Polished Chrome / White Glass
CUL damp location



Round Sunburst Design

(2) 60W A19 max. / Medium Base
Dimensions: Width 12", Height 4³/₄"
76-269 White Holder
CUL damp location



Small Flush Drum

(1) 60W A19 max. / Medium Base
Dimensions: Width 6", Height 5"
77-342 Polished Chrome / White Glass
CUL damp location



Round White

(2) 60W A19 max. / Medium Base
Dimensions: Width 12", Height 4³/₄"
77-823 White Holder
CUL damp location

CLOSE-TO-CEILING



Square Wheat Design / Ruffled Edge

(2) 60W A19 max. / Medium Base
Dimensions: Width 11 3/4", Height 4 3/4"
76-270 White Holder
CUL damp location



Square Floral Design

with Pull Chain Switch
(2) 60W A19 max. / Medium Base
Dimensions: Width 11 3/4", Height 4 3/4"
77-392 White Holder
CUL damp location



Square White

(2) 60W A19 max. / Medium Base
Dimensions: Width 11 3/4", Height 4 3/4"
77-824 White Holder
CUL damp location



Square Floral Design

(2) 60W A19 max. / Medium Base
Dimensions: Width 11 3/4", Height 4 3/4"
77-126 White Holder
CUL damp location



R20 / PAR20 1 Light Straight Cylinder

(1) 50W R20 / PAR20 Halogen max. / Medium Base

Dimensions: Height 8½", Canopy 5"

76-412 White / Black Baffle

CUL damp location



R20 / PAR20 3 Light Straight Cylinder

(3) 50W R20 / PAR20 Halogen max. / Medium Base

Dimensions: Height 8½", Width 14", Canopy 10"

76-416 White / Black Baffle

CUL damp location



R30 / PAR30 1 Light Straight Cylinder

(1) 75W R30 / 50W PAR30 Halogen max. / Medium Base

Dimensions: Height 10", Canopy 5"

76-418 White / Black Baffle

CUL damp location



R30 / PAR30 3 Light Straight Cylinder

(3) 75W R30 / 50W PAR30 Halogen max. / Medium Base

Dimensions: Height 10", Width 18", Canopy 10"

76-422 White / Black Baffle

CUL damp location

PENDANTS



Dupont Three Light Pendant

(3) 60W A19 max. / Medium Base
 Dimensions: Width 16", Height 20", Chain 48", Wire 12'
60-1828 Brushed Nickel / Satin White Glass
 Accessories:
25-1069 3' Section of matching chain



Dupont Hanging Dome

(1) 100W A19 max. / Medium Base
 Dimensions: Width 16", Height 10½", Chain 48", Wire 12'
60-1829 Brushed Nickel / Satin White Glass
 Accessories:
25-1069 3' Section of matching chain



Dupont Three Light Pendant

(3) 60W A19 max. / Medium Base
 Dimensions: Width 16", Height 20", Chain 48", Wire 12'
60-1848 Dark Chocolate Bronze / Satin White Glass
 Accessories:
25-3024 3' Section of matching chain



Dupont Hanging Dome

(1) 100W A19 max. / Medium Base
 Dimensions: Width 16", Height 10½", Chain 48", Wire 12'
60-1849 Dark Chocolate Bronze / Satin White Glass
 Accessories:
25-3024 3' Section of matching chain



20" Pendant

(3) 60W A19 max. / Medium Base
 Dimensions: Width 20", Height 27¾", Chain 48", Wire 12'
60-204 Brushed Nickel / Alabaster Glass
 Accessories:
25-1069 3' Section of matching chain



15" Pendant

(3) 60W A19 max. / Medium Base
 Dimensions: Width 15", Height 23", Chain 48", Wire 12'
60-203 Brushed Nickel / Alabaster Glass
 Accessories:
25-1069 3' Section of matching chain



20" Pendant

(3) 60W A19 max. / Medium Base
Dimensions: Width 20", Height 27³/₄", Chain 48", Wire 12'
60-3248 Brushed Nickel / Frosted Glass
Accessories:
25-1069 3' Section of matching chain



15" Pendant

(3) 60W A19 max. / Medium Base
Dimensions: Width 15", Height 23", Chain 48", Wire 12'
60-3247 Brushed Nickel / Frosted Glass
Accessories:
25-1069 3' Section of matching chain



20" Pendant

(3) 60W A19 max. / Medium Base
Dimensions: Width 20", Height 27³/₄", Chain 48", Wire 12'
60-212 Old Bronze / Alabaster Glass
Accessories:
25-1067 3' Section of matching chain



15" Pendant

(3) 60W A19 max. / Medium Base
Dimensions: Width 15", Height 23", Chain 48", Wire 12'
60-211 Old Bronze / Alabaster Glass
Accessories:
25-1067 3' Section of matching chain



20" Pendant

(3) 60W A19 max. / Medium Base
Dimensions: Width 20", Height 27³/₄", Chain 48", Wire 12'
60-3153 Mahogany Bronze / Frosted Glass
Accessories:
25-2081 3' Section of matching chain



15" Pendant

(3) 60W A19 max. / Medium Base
Dimensions: Width 15", Height 23", Chain 48", Wire 12'
60-3152 Mahogany Bronze / Frosted Glass
Accessories:
25-2081 3' Section of matching chain

PENDANTS



Hanging Dome

(1) 100W A19 max. / Medium Base
Dimensions: Width 16", Height 11 1/2", Chain 48", Wire 12'
60-390 Brushed Nickel / Alabaster Glass
Accessories:
25-1069 3' Section of matching chain



Pendant Bell

(1) 100W A19 max. / Medium Base
Dimensions: Width 9 3/4", Height 20 1/2", Chain 48", Wire 12'
60-394 Brushed Nickel / Alabaster Glass
Accessories:
25-1069 3' Section of matching chain



Hanging Dome

(1) 100W A19 max. / Medium Base
Dimensions: Width 16", Height 11 1/2", Chain 48", Wire 12'
60-3258 Brushed Nickel / Frosted Glass
Accessories:
25-1069 3' Section of matching chain



Pendant Bell

(1) 100W A19 max. / Medium Base
Dimensions: Width 9 3/4", Height 20 1/2", Chain 48", Wire 12'
60-3259 Brushed Nickel / Frosted Glass
Accessories:
25-1069 3' Section of matching chain



Hanging Dome

(1) 100W A19 max. / Medium Base
Dimensions: Width 16", Height 11 1/2", Chain 48", Wire 12'
60-391 Old Bronze / Alabaster Glass
Accessories:
25-1067 3' Section of matching chain



Pendant Bell

(1) 100W A19 max. / Medium Base
Dimensions: Width 9 3/4", Height 20 1/2", Chain 48", Wire 12'
60-395 Old Bronze / Alabaster Glass
Accessories:
25-1067 3' Section of matching chain



Hanging Dome

(1) 100W A19 max. / Medium Base
Dimensions: Width 16", Height 11 1/2", Chain 48", Wire 12'
60-3173 Mahogany Bronze / Frosted Glass
Accessories:
25-2081 3' Section of matching chain



Pendant Bell

(1) 100W A19 max. / Medium Base
Dimensions: Width 9 3/4", Height 20 1/2", Chain 48", Wire 12'
60-3174 Mahogany Bronze / Frosted Glass
Accessories:
25-2081 3' Section of matching chain



Hanging Dome

(1) 100W A19 max. / Medium Base
Dimensions: Width 16", Height 11 1/2", Chain 48", Wire 12'
60-1276 Mahogany Bronze / Champagne Glass
Accessories:
25-2081 3' Section of matching chain



Hanging Dome

(1) 100W A19 max. / Medium Base
Dimensions: Width 16", Height 11 1/2", Chain 48", Wire 12'
60-393 Textured White / Alabaster Glass
Accessories:
25-1072 3' Section of matching chain



Hanging Dome

(1) 100W A19 max. / Medium Base
Dimensions: Width 16", Height 11 1/2", Chain 48", Wire 12'
60-392 Polished Brass / Alabaster Glass
Accessories:
25-1066 3' Section of matching chain

PENDANTS



Three Light Pendant

(3) 60W A19 max. / Medium Base
Dimensions: Width 22½", Height 20½", Chain 48", Wire 12'
60-370 Brushed Nickel / Alabaster Glass
Accessories:
25-1069 3' Section of Brushed Nickel chain



Three Light Pendant

(3) 60W A19 max. / Medium Base
Dimensions: Width 22½", Height 20½", Chain 48", Wire 12'
60-371 Old Bronze / Alabaster Glass
Accessories:
25-1067 3' Section of Old Bronze chain



Prismatic Dome

(1) 100W A19 max. / Medium Base
Dimensions: Width 15", Height 10½", Chain 36", Wire 12'
76-446 Brushed Nickel / Clear Ribbed Glass
Accessories:
25-1069 3' Section of Brushed Nickel chain



Prismatic Dome

(1) 100W A19 max. / Medium Base
Dimensions: Width 15", Height 10½", Chain 36", Wire 12'
76-447 Old Bronze / Clear Ribbed Glass
Accessories:
25-1067 3' Section of Old Bronze chain



Prismatic Dome

(1) 100W A19 max. / Medium Base
Dimensions: Width 15", Height 10½", Chain 36", Wire 12'
76-691 Brushed Nickel / Frosted Ribbed Glass
Accessories:
25-1069 3' Section of Brushed Nickel chain



Prismatic Dome

(1) 100W A19 max. / Medium Base
Dimensions: Width 15", Height 10½", Chain 36", Wire 12'
76-690 Old Bronze / Frosted Ribbed Glass
Accessories:
25-1067 3' Section of Old Bronze chain



Warehouse Shade

(1) 100W A19 max. / Medium Base
Dimensions: Width 16", Height 8 1/8", Cord 12'
76-661 Brushed Nickel



Warehouse Shade

(1) 100W A19 max. / Medium Base
Dimensions: Width 16", Height 8 1/8", Cord 12'
76-662 Old Bronze



Warehouse Shade

(1) 100W A19 max. / Medium Base
Dimensions: Width 16", Height 8 1/8", Cord 12'
76-663 Red



Warehouse Shade

(1) 100W A19 max. / Medium Base
Dimensions: Width 16", Height 8 1/8", Cord 12'
76-660 Green



Warehouse Shade

(1) 100W A19 max. / Medium Base
Dimensions: Width 16", Height 8 1/8", Cord 12'
76-284 Black



Warehouse Shade

(1) 100W A19 max. / Medium Base
Dimensions: Width 16", Height 8 1/8", Cord 12'
76-283 White

MINI PENDANTS



Dupont Mini Pendant

(1) 60W A19 max. / Medium Base

Dimensions: Width 6", Height 7 1/2", Wire 12'

60-1831 Brushed Nickel / Satin White Glass

Accessories:

Additional Stem Lengths

25-2047 (6"), **25-2021** (12")



Dupont Mini Pendant

(1) 60W A19 max. / Medium Base

Dimensions: Width 6", Height 7 1/2", Wire 12'

60-1851 Dark Chocolate Bronze / Satin White Glass

Accessories:

Additional Stem Lengths

25-4007 (6"), **25-4008** (12")



Empire Mini Pendant

with hang-straight canopy

(1) 100W A19 max. / Medium Base

Dimensions: Width 7", Height 6 1/2", Wire 12'

60-365 Brushed Nickel / Alabaster Glass

Accessories:

Additional Stem Lengths

25-2047 (6"), **25-2021** (12")



Empire Mini Pendant

with hang-straight canopy

(1) 100W A19 max. / Medium Base

Dimensions: Width 7", Height 6 1/2", Wire 12'

60-3257 Brushed Nickel / Frosted Glass

Accessories:

Additional Stem Lengths

25-2047 (6"), **25-2021** (12")



Empire Mini Pendant

with hang-straight canopy

(1) 100W A19 max. / Medium Base

Dimensions: Width 7", Height 6 1/2", Wire 12'

60-366 Old Bronze / Alabaster Glass

Accessories:

Additional Stem Lengths

25-2028 (6"), **25-2002** (12")



Empire Mini Pendant

with hang-straight canopy

(1) 100W A19 max. / Medium Base

Dimensions: Width 7", Height 6 1/2", Wire 12'

60-3172 Mahogany Bronze / Frosted Glass

Accessories:

Additional Stem Lengths

25-2078 (6"), **25-2079** (12")



Empire Mini Pendant

with hang-straight canopy

(1) 100W A19 max. / Medium Base

Dimensions: Width 7", Height 6 1/2", Wire 12'

60-1277 Mahogany Bronze / Champagne Glass

Accessories:

Additional Stem Lengths

25-2078 (6"), **25-2079** (12")



Empire Mini Pendant

with hang-straight canopy

(1) 100W A19 max. / Medium Base

Dimensions: Width 7", Height 6 1/2", Wire 12'

60-368 Textured White / Alabaster Glass

Accessories:

Additional Stem Lengths

25-2053 (6"), **25-2026** (12")



Empire Mini Pendant

with hang-straight canopy

(1) 100W A19 max. / Medium Base

Dimensions: Width 7", Height 6 1/2", Wire 12'

60-367 Polished Brass / Alabaster Glass

Accessories:

Additional Stem Lengths

25-2046 (6"), **25-2019** (12")

VANITY



Dupont One Light Vanity

(1) 100W A19 max. / Medium Base

Dimensions: Width 6", Height 8", Extension 8 1/2"

60-1832 Brushed Nickel / Satin White Glass



Dupont Two Light Vanity

(2) 100W A19 max. / Medium Base

Dimensions: Width 13", Height 8", Extension 7 3/4"

60-1833 Brushed Nickel / Satin White Glass



Dupont Three Light Vanity

(3) 100W A19 max. / Medium Base

Dimensions: Width 24", Height 8", Extension 7 3/4"

60-1834 Brushed Nickel / Satin White Glass



Dupont Four Light Vanity

(4) 100W A19 max. / Medium Base

Dimensions: Width 30", Height 8", Extension 7 3/4"

60-1835 Brushed Nickel / Satin White Glass



Dupont One Light Vanity

(1) 100W A19 max. / Medium Base

Dimensions: Width 6", Height 8", Extension 8 1/2"

60-1852 Dark Chocolate Bronze / Satin White Glass



Dupont Two Light Vanity

(2) 100W A19 max. / Medium Base

Dimensions: Width 13", Height 8", Extension 7 3/4"

60-1853 Dark Chocolate Bronze / Satin White Glass



Dupont Three Light Vanity

(3) 100W A19 max. / Medium Base

Dimensions: Width 24", Height 8", Extension 7 3/4"

60-1854 Dark Chocolate Bronze / Satin White Glass



Dupont Four Light Vanity

(4) 100W A19 max. / Medium Base

Dimensions: Width 30", Height 8", Extension 7 3/4"

60-1855 Dark Chocolate Bronze / Satin White Glass

VANITY



Ballerina Two Light 18" Vanity

(2) 100W A19 max. / Medium Base

Dimensions: Width 18", Height 7⁵/₈", Extension 8¹/₂"

60-320 Brushed Nickel / Alabaster Glass



Ballerina Three Light 24" Vanity

(3) 100W A19 max. / Medium Base

Dimensions: Width 24", Height 7⁵/₈", Extension 8¹/₂"

60-321 Brushed Nickel / Alabaster Glass



Ballerina Four Light 30" Vanity

(4) 100W A19 max. / Medium Base

Dimensions: Width 30", Height 7⁵/₈", Extension 8¹/₂"

60-322 Brushed Nickel / Alabaster Glass



Ballerina Five Light 36" Vanity

(5) 100W A19 max. / Medium Base

Dimensions: Width 36", Height 7⁵/₈", Extension 8¹/₂"

60-323 Brushed Nickel / Alabaster Glass



Ballerina Seven Light 48" Vanity

(7) 100W A19 max. / Medium Base

Dimensions: Width 48", Height 7⁵/₈", Extension 8¹/₂"

60-291 Brushed Nickel / Alabaster Glass



Ballerina Two Light 18" Vanity

(2) 100W A19 max. / Medium Base

Dimensions: Width 18", Height 7⁵/₈", Extension 8¹/₂"

60-3278 Brushed Nickel / Frosted Glass



Ballerina Three Light 24" Vanity

(3) 100W A19 max. / Medium Base

Dimensions: Width 24", Height 7⁵/₈", Extension 8¹/₂"

60-3279 Brushed Nickel / Frosted Glass



Ballerina Four Light 30" Vanity

(4) 100W A19 max. / Medium Base

Dimensions: Width 30", Height 7⁵/₈", Extension 8¹/₂"

60-3281 Brushed Nickel / Frosted Glass



Ballerina Five Light 36" Vanity

(5) 100W A19 max. / Medium Base

Dimensions: Width 36", Height 7⁵/₈", Extension 8¹/₂"

60-3282 Brushed Nickel / Frosted Glass



Ballerina Seven Light 48" Vanity

(7) 100W A19 max. / Medium Base

Dimensions: Width 48", Height 7⁵/₈", Extension 8¹/₂"

60-3283 Brushed Nickel / Frosted Glass

VANITY



Ballerina Two Light 18" Vanity

(2) 100W A19 max. / Medium Base

Dimensions: Width 18", Height 7⁵/₈", Extension 8¹/₂"

60-324 Old Bronze / Alabaster Glass



Ballerina Three Light 24" Vanity

(3) 100W A19 max. / Medium Base

Dimensions: Width 24", Height 7⁵/₈", Extension 8¹/₂"

60-325 Old Bronze / Alabaster Glass



Ballerina Four Light 30" Vanity

(4) 100W A19 max. / Medium Base

Dimensions: Width 30", Height 7⁵/₈", Extension 8¹/₂"

60-326 Old Bronze / Alabaster Glass



Ballerina Five Light 36" Vanity

(5) 100W A19 max. / Medium Base

Dimensions: Width 36", Height 7⁵/₈", Extension 8¹/₂"

60-327 Old Bronze / Alabaster Glass



Ballerina Seven Light 48" Vanity

(7) 100W A19 max. / Medium Base

Dimensions: Width 48", Height 7⁵/₈", Extension 8¹/₂"

60-292 Old Bronze / Alabaster Glass



Ballerina Two Light 18" Vanity

(2) 100W A19 max. / Medium Base

Dimensions: Width 18", Height 7⁵/₈", Extension 8¹/₂"

60-3161 Mahogany Bronze / Frosted Glass



Ballerina Three Light 24" Vanity

(3) 100W A19 max. / Medium Base

Dimensions: Width 24", Height 7⁵/₈", Extension 8¹/₂"

60-3162 Mahogany Bronze / Frosted Glass



Ballerina Four Light 30" Vanity

(4) 100W A19 max. / Medium Base

Dimensions: Width 30", Height 7⁵/₈", Extension 8¹/₂"

60-3163 Mahogany Bronze / Frosted Glass



Ballerina Five Light 36" Vanity

(5) 100W A19 max. / Medium Base

Dimensions: Width 36", Height 7⁵/₈", Extension 8¹/₂"

60-3164 Mahogany Bronze / Frosted Glass



Ballerina Seven Light 48" Vanity

(7) 100W A19 max. / Medium Base

Dimensions: Width 48", Height 7⁵/₈", Extension 8¹/₂"

60-3155 Mahogany Bronze / Frosted Glass

VANITY



Ballerina Two Light 18" Vanity

(2) 100W A19 max. / Medium Base

Dimensions: Width 18", Height 7⁵/₈", Extension 8¹/₂"

60-1264 Mahogany Bronze / Champagne Glass



Ballerina Three Light 24" Vanity

(3) 100W A19 max. / Medium Base

Dimensions: Width 24", Height 7⁵/₈", Extension 8¹/₂"

60-1265 Mahogany Bronze / Champagne Glass



Ballerina Four Light 30" Vanity

(4) 100W A19 max. / Medium Base

Dimensions: Width 30", Height 7⁵/₈", Extension 8¹/₂"

60-1266 Mahogany Bronze / Champagne Glass



Ballerina Five Light 36" Vanity

(5) 100W A19 max. / Medium Base

Dimensions: Width 36", Height 7⁵/₈", Extension 8¹/₂"

60-1267 Mahogany Bronze / Champagne Glass



Ballerina Seven Light 48" Vanity

(7) 100W A19 max. / Medium Base

Dimensions: Width 48", Height 7⁵/₈", Extension 8¹/₂"

60-1268 Mahogany Bronze / Champagne Glass



Ballerina Two Light 18" Vanity

(2) 100W A19 max. / Medium Base

Dimensions: Width 18", Height 7⁵/₈", Extension 8¹/₂"

60-328 Polished Brass / Alabaster Glass



Ballerina Three Light 24" Vanity

(3) 100W A19 max. / Medium Base

Dimensions: Width 24", Height 7⁵/₈", Extension 8¹/₂"

60-329 Polished Brass / Alabaster Glass



Ballerina Four Light 30" Vanity

(4) 100W A19 max. / Medium Base

Dimensions: Width 30", Height 7⁵/₈", Extension 8¹/₂"

60-330 Polished Brass / Alabaster Glass



Ballerina Five Light 36" Vanity

(5) 100W A19 max. / Medium Base

Dimensions: Width 36", Height 7⁵/₈", Extension 8¹/₂"

60-331 Polished Brass / Alabaster Glass



Ballerina Seven Light 48" Vanity

(7) 100W A19 max. / Medium Base

Dimensions: Width 48", Height 7⁵/₈", Extension 8¹/₂"

60-293 Polished Brass / Alabaster Glass

VANITY



Ballerina Two Light 18" Vanity

(2) 100W A19 max. / Medium Base

Dimensions: Width 18", Height 7⁵/₈", Extension 8¹/₂"

60-332 Textured White / Alabaster Glass



Ballerina Three Light 24" Vanity

(3) 100W A19 max. / Medium Base

Dimensions: Width 24", Height 7⁵/₈", Extension 8¹/₂"

60-333 Textured White / Alabaster Glass



Ballerina Four Light 30" Vanity

(4) 100W A19 max. / Medium Base

Dimensions: Width 30", Height 7⁵/₈", Extension 8¹/₂"

60-334 Textured White / Alabaster Glass



Ballerina Five Light 36" Vanity

(5) 100W A19 max. / Medium Base

Dimensions: Width 36", Height 7⁵/₈", Extension 8¹/₂"

60-335 Textured White / Alabaster Glass



Ballerina Seven Light 48" Vanity

(7) 100W A19 max. / Medium Base

Dimensions: Width 48", Height 7⁵/₈", Extension 8¹/₂"

60-294 Textured White / Alabaster Glass



Ballerina Two Light 18" Vanity

(2) 100W A19 max. / Medium Base

Dimensions: Width 18", Height 7⁵/₈", Extension 8¹/₂"

60-316 Polished Chrome / Alabaster Glass



Ballerina Three Light 24" Vanity

(3) 100W A19 max. / Medium Base

Dimensions: Width 24", Height 7⁵/₈", Extension 8¹/₂"

60-317 Polished Chrome / Alabaster Glass

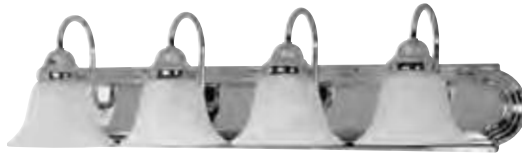

Ballerina Four Light 30" Vanity

(4) 100W A19 max. / Medium Base

Dimensions: Width 30", Height 7⁵/₈", Extension 8¹/₂"

60-318 Polished Chrome / Alabaster Glass



Ballerina Five Light 36" Vanity

(5) 100W A19 max. / Medium Base

Dimensions: Width 36", Height 7⁵/₈", Extension 8¹/₂"

60-319 Polished Chrome / Alabaster Glass



Ballerina Seven Light 48" Vanity

(7) 100W A19 max. / Medium Base

Dimensions: Width 48", Height 7⁵/₈", Extension 8¹/₂"

60-290 Polished Chrome / Alabaster Glass

VANITY



Empire One Light Vanity

(1) 100W A19 max. / Medium Base

Dimensions: Width 6 $\frac{1}{4}$ ", Height 6 $\frac{1}{8}$ ", Extension 9"

60-340 Brushed Nickel / Alabaster Glass



Empire Two Light Vanity

(2) 100W A19 max. / Medium Base

Dimensions: Width 14 $\frac{7}{8}$ ", Height 6 $\frac{1}{8}$ ", Extension 8"

60-341 Brushed Nickel / Alabaster Glass



Empire Three Light Vanity

(3) 100W A19 max. / Medium Base

Dimensions: Width 20 $\frac{1}{2}$ ", Height 6 $\frac{1}{8}$ ", Extension 8"

60-342 Brushed Nickel / Alabaster Glass



Empire Four Light Vanity

(4) 100W A19 max. / Medium Base

Dimensions: Width 28 $\frac{3}{4}$ ", Height 6 $\frac{1}{8}$ ", Extension 8"

60-343 Brushed Nickel / Alabaster Glass



Empire One Light Vanity

(1) 100W A19 max. / Medium Base

Dimensions: Width 6¹/₄", Height 6¹/₈", Extension 9"

60-3264 Brushed Nickel / Frosted Glass



Empire Two Light Vanity

(2) 100W A19 max. / Medium Base

Dimensions: Width 14⁷/₈", Height 6¹/₈", Extension 8"

60-3265 Brushed Nickel / Frosted Glass



Empire Three Light Vanity

(3) 100W A19 max. / Medium Base

Dimensions: Width 20¹/₂", Height 6¹/₈", Extension 8"

60-3266 Brushed Nickel / Frosted Glass



Empire Four Light Vanity

(4) 100W A19 max. / Medium Base

Dimensions: Width 28³/₄", Height 6¹/₈", Extension 8"

60-3277 Brushed Nickel / Frosted Glass

VANITY



Empire One Light Vanity

(1) 100W A19 max. / Medium Base

Dimensions: Width 6 1/4", Height 6 1/8", Extension 9"

60-344 Old Bronze / Alabaster Glass



Empire Two Light Vanity

(2) 100W A19 max. / Medium Base

Dimensions: Width 14 7/8", Height 6 1/8", Extension 8"

60-345 Old Bronze / Alabaster Glass



Empire Three Light Vanity

(3) 100W A19 max. / Medium Base

Dimensions: Width 20 1/2", Height 6 1/8", Extension 8"

60-346 Old Bronze / Alabaster Glass



Empire Four Light Vanity

(4) 100W A19 max. / Medium Base

Dimensions: Width 28 3/4", Height 6 1/8", Extension 8"

60-347 Old Bronze / Alabaster Glass



Empire One Light Vanity

(1) 100W A19 max. / Medium Base

Dimensions: Width 6 1/4", Height 6 1/8", Extension 9"

60-3165 Mahogany Bronze / Frosted Glass



Empire Two Light Vanity

(2) 100W A19 max. / Medium Base

Dimensions: Width 14 7/8", Height 6 1/8", Extension 8"

60-3166 Mahogany Bronze / Frosted Glass



Empire Three Light Vanity

(3) 100W A19 max. / Medium Base

Dimensions: Width 20 1/2", Height 6 1/8", Extension 8"

60-3167 Mahogany Bronze / Frosted Glass



Empire Four Light Vanity

(4) 100W A19 max. / Medium Base

Dimensions: Width 28 3/4", Height 6 1/8", Extension 8"

60-3168 Mahogany Bronze / Frosted Glass

VANITY



Empire One Light Vanity

(1) 100W A19 max. / Medium Base

Dimensions: Width 6 1/4", Height 6 1/8", Extension 9"

60-1269 Mahogany Bronze / Champagne Glass



Empire Two Light Vanity

(2) 100W A19 max. / Medium Base

Dimensions: Width 14 7/8", Height 6 1/8", Extension 8"

60-1271 Mahogany Bronze / Champagne Glass



Empire Three Light Vanity

(3) 100W A19 max. / Medium Base

Dimensions: Width 20 1/2", Height 6 1/8", Extension 8"

60-1272 Mahogany Bronze / Champagne Glass



Empire Four Light Vanity

(4) 100W A19 max. / Medium Base

Dimensions: Width 28 3/4", Height 6 1/8", Extension 8"

60-1273 Mahogany Bronze / Champagne Glass



Empire One Light Vanity

(1) 100W A19 max. / Medium Base

Dimensions: Width 6¹/₄", Height 6¹/₈", Extension 9"

60-348 Polished Brass / Alabaster Glass



Empire Two Light Vanity

(2) 100W A19 max. / Medium Base

Dimensions: Width 14⁷/₈", Height 6¹/₈", Extension 8"

60-349 Polished Brass / Alabaster Glass



Empire Three Light Vanity

(3) 100W A19 max. / Medium Base

Dimensions: Width 20¹/₂", Height 6¹/₈", Extension 8"

60-350 Polished Brass / Alabaster Glass



Empire Four Light Vanity

(4) 100W A19 max. / Medium Base

Dimensions: Width 28³/₄", Height 6¹/₈", Extension 8"

60-351 Polished Brass / Alabaster Glass

VANITY



Empire One Light Vanity

(1) 100W A19 max. / Medium Base

Dimensions: Width 6 $\frac{1}{4}$ ", Height 6 $\frac{1}{8}$ ", Extension 9"

60-352 Textured White / Alabaster Glass



Empire Two Light Vanity

(2) 100W A19 max. / Medium Base

Dimensions: Width 14 $\frac{7}{8}$ ", Height 6 $\frac{1}{8}$ ", Extension 8"

60-353 Textured White / Alabaster Glass



Empire Three Light Vanity

(3) 100W A19 max. / Medium Base

Dimensions: Width 20 $\frac{1}{2}$ ", Height 6 $\frac{1}{8}$ ", Extension 8"

60-354 Textured White / Alabaster Glass



Empire Four Light Vanity

(4) 100W A19 max. / Medium Base

Dimensions: Width 28 $\frac{3}{4}$ ", Height 6 $\frac{1}{8}$ ", Extension 8"

60-355 Textured White / Alabaster Glass



Empire One Light Vanity

(1) 100W A19 max. / Medium Base

Dimensions: Width 6 $\frac{1}{4}$ ", Height 6 $\frac{1}{8}$ ", Extension 9"

60-336 Polished Chrome / Alabaster Glass



Empire Two Light Vanity

(2) 100W A19 max. / Medium Base

Dimensions: Width 14 $\frac{7}{8}$ ", Height 6 $\frac{1}{8}$ ", Extension 8"

60-337 Polished Chrome / Alabaster Glass



Empire Three Light Vanity

(3) 100W A19 max. / Medium Base

Dimensions: Width 20 $\frac{1}{2}$ ", Height 6 $\frac{1}{8}$ ", Extension 8"

60-338 Polished Chrome / Alabaster Glass



Empire Four Light Vanity

(4) 100W A19 max. / Medium Base

Dimensions: Width 28 $\frac{3}{4}$ ", Height 6 $\frac{1}{8}$ ", Extension 8"

60-339 Polished Chrome / Alabaster Glass

VANITY



18" Three Light Vanity Strip

(3) 100W Type G max. / Medium Base

Dimensions: Width 18", Height 4³/₄",
Extension 2" (less lamp)

60-300 Brushed Nickel



24" Four Light Vanity Strip

(4) 100W Type G max. / Medium Base

Dimensions: Width 24", Height 4³/₄",
Extension 2" (less lamp)

60-301 Brushed Nickel



36" Six Light Vanity Strip

(6) 100W Type G max. / Medium Base

Dimensions: Width 36", Height 4³/₄",
Extension 2" (less lamp)

60-302 Brushed Nickel



48" Eight Light Vanity Strip

(8) 100W Type G max. / Medium Base

Dimensions: Width 48", Height 4³/₄",
Extension 2" (less lamp)

60-303 Brushed Nickel



18" Three Light Vanity Strip

(3) 100W Type G max. / Medium Base

Dimensions: Width 18", Height 4³/₄",
Extension 2" (less lamp)

60-304 Old Bronze



24" Four Light Vanity Strip

(4) 100W Type G max. / Medium Base

Dimensions: Width 24", Height 4³/₄",
Extension 2" (less lamp)

60-305 Old Bronze



36" Six Light Vanity Strip

(6) 100W Type G max. / Medium Base

Dimensions: Width 36", Height 4³/₄",
Extension 2" (less lamp)

60-306 Old Bronze



48" Eight Light Vanity Strip

(8) 100W Type G max. / Medium Base

Dimensions: Width 48", Height 4³/₄",
Extension 2" (less lamp)

60-307 Old Bronze

VANITY



18" Three Light Vanity Strip

(3) 100W Type G max. / Medium Base

Dimensions: Width 18", Height 4³/₄",
Extension 2" (less lamp)

60-1284 Mahogany Bronze



24" Four Light Vanity Strip

(4) 100W Type G max. / Medium Base

Dimensions: Width 24", Height 4³/₄",
Extension 2" (less lamp)

60-1285 Mahogany Bronze



36" Six Light Vanity Strip

(6) 100W Type G max. / Medium Base

Dimensions: Width 36", Height 4³/₄",
Extension 2" (less lamp)

60-1286 Mahogany Bronze



48" Eight Light Vanity Strip

(8) 100W Type G max. / Medium Base

Dimensions: Width 48", Height 4³/₄",
Extension 2" (less lamp)

60-1287 Mahogany Bronze



18" Three Light Vanity Strip

(3) 100W Type G max. / Medium Base

Dimensions: Width 18", Height 4³/₄",
Extension 2" (less lamp)

60-308 Polished Brass



24" Four Light Vanity Strip

(4) 100W Type G max. / Medium Base

Dimensions: Width 24", Height 4³/₄",
Extension 2" (less lamp)

60-309 Polished Brass



36" Six Light Vanity Strip

(6) 100W Type G max. / Medium Base

Dimensions: Width 36", Height 4³/₄",
Extension 2" (less lamp)

60-310 Polished Brass



48" Eight Light Vanity Strip

(8) 100W Type G max. / Medium Base

Dimensions: Width 48", Height 4³/₄",
Extension 2" (less lamp)

60-311 Polished Brass

VANITY



18" Three Light Vanity Strip

(3) 100W Type G max. / Medium Base

Dimensions: Width 18", Height 4³/₄",
Extension 2" (less lamp)

60-312 Textured White



24" Four Light Vanity Strip

(4) 100W Type G max. / Medium Base

Dimensions: Width 24", Height 4³/₄",
Extension 2" (less lamp)

60-313 Textured White



36" Six Light Vanity Strip

(6) 100W Type G max. / Medium Base

Dimensions: Width 36", Height 4³/₄",
Extension 2" (less lamp)

60-314 Textured White



48" Eight Light Vanity Strip

(8) 100W Type G max. / Medium Base

Dimensions: Width 48", Height 4³/₄",
Extension 2" (less lamp)

60-315 Textured White



18" Three Light Vanity Strip

(3) 100W Type G max. / Medium Base

Dimensions: Width 18", Height 4³/₄",
Extension 2" (less lamp)

60-296 Polished Chrome



24" Four Light Vanity Strip

(4) 100W Type G max. / Medium Base

Dimensions: Width 24", Height 4³/₄",
Extension 2" (less lamp)

60-297 Polished Chrome



36" Six Light Vanity Strip

(6) 100W Type G max. / Medium Base

Dimensions: Width 36", Height 4³/₄",
Extension 2" (less lamp)

60-298 Polished Chrome



48" Eight Light Vanity Strip

(8) 100W Type G max. / Medium Base

Dimensions: Width 48", Height 4³/₄",
Extension 2" (less lamp)

60-299 Polished Chrome

VANITY



18" Three Light Vanity Strip

(3) 100W Type G max. / Medium Base

Dimensions: Width 18", Height 4³/₄",
Extension 2" (less lamp)

77-188 Polished Brass



24" Four Light Vanity Strip

(4) 100W Type G max. / Medium Base

Dimensions: Width 24", Height 4³/₄",
Extension 2" (less lamp)

77-189 Polished Brass



36" Six Light Vanity Strip

(6) 100W Type G max. / Medium Base

Dimensions: Width 36", Height 4³/₄",
Extension 2" (less lamp)

77-190 Polished Brass



48" Eight Light Vanity Strip

(8) 100W Type G max. / Medium Base

Dimensions: Width 48", Height 4³/₄",
Extension 2" (less lamp)

77-191 Polished Brass



18" Three Light Vanity Strip

(3) 100W Type G max. / Medium Base

Dimensions: Width 18", Height 4³/₄", Extension 2" (less lamp)

77-192 Polished Chrome



24" Four Light Vanity Strip

(4) 100W Type G max. / Medium Base

Dimensions: Width 24", Height 4³/₄", Extension 2" (less lamp)

77-193 Polished Chrome



30" Five Light Vanity Strip

(6) 100W Type G max. / Medium Base

Dimensions: Width 30", Height 4³/₄", Extension 2" (less lamp)

77-196 Polished Chrome



36" Six Light Vanity Strip

(6) 100W Type G max. / Medium Base

Dimensions: Width 36", Height 4³/₄", Extension 2" (less lamp)

77-194 Polished Chrome



48" Eight Light Vanity Strip

(8) 100W Type G max. / Medium Base

Dimensions: Width 48", Height 4³/₄", Extension 2" (less lamp)

77-195 Polished Chrome

VANITY / WALL



7" "U" Channel Glass

(1) 60W A19 max. / Medium Base

Dimensions: Width 4 1/2", Height 7 1/2",
Extension 4 1/4"

76-273 White / White Diamond Glass



7" "U" Channel Glass

(1) 60W A19 max. / Medium Base

Dimensions: Width 4 1/2", Height 7 1/2",
Extension 4 1/4"

77-989 White / White Glass
w/ Bottom Turn Switch



7" "U" Channel Glass

(1) 60W A19 max. / Medium Base

Dimensions: Width 4 1/2", Height 7 1/2",
Extension 4 1/4"

77-086 White / White Glass



14" "U" Channel Glass

(2) 60W A19 max. / Medium Base

Dimensions: Width 14", Height 4 3/4", Extension 4 1/4"

76-276 White / White Diamond Glass



14" "U" Channel Glass

(2) 60W A19 max. / Medium Base

Dimensions: Width 14", Height 4 3/4", Extension 4 1/4"

77-087 White / White Glass



14" "U" Channel Glass

(2) 60W A19 max. / Medium Base

Dimensions: Width 14", Height 4 3/4", Extension 4 1/4"

77-990 White / White Glass w/ Convenience Outlet



24" "U" Channel Glass

(4) 60W A19 max. / Medium Base

Dimensions: Width 24", Height 4³/₄", Extension 4¹/₄"

76-277 White / White Diamond Glass



24" "U" Channel Glass

(4) 60W A19 max. / Medium Base

Dimensions: Width 24", Height 4³/₄", Extension 4¹/₄"

77-088 White / White Glass



24" "U" Channel Glass

(4) 60W A19 max. / Medium Base

Dimensions: Width 24", Height 4³/₄", Extension 4¹/₄"

77-991 White / White Glass w/ Convenience Outlet



Crystal Bottom Bath Shade

(1) 60W A19 max. / Medium Base

Dimensions: Width 4³/₄", Height 4³/₄", Extension 6³/₄"

77-121 Chrome / White Glass, Crystal Bottom,
with Convenience Outlet



Frosted Grape Shade

(1) 60W A19 max. / Medium Base

Dimensions: Width 4¹/₂", Height 7³/₄", Extension 4⁷/₈"

77-120 Polished Brass / Frosted Glass,
with On-Off Switch

SCONCE

Ballerina One Light Sconce

(1) 60W A19 max. / Medium Base
Dimensions: Width 15⁷/₈", Height 7", Extension 7⁷/₈"
60-5381 Brushed Nickel / Alabaster Glass
(glass up installation only)



Ballerina One Light Sconce

(1) 60W A19 max. / Medium Base
Dimensions: Width 15⁷/₈", Height 7", Extension 7⁷/₈"
60-5382 Brushed Nickel / Frosted Glass
(glass up installation only)



Ballerina One Light Sconce

(1) 60W A19 max. / Medium Base
Dimensions: Width 15⁷/₈", Height 7", Extension 7⁷/₈"
60-5378 Old Bronze / Alabaster Glass
(glass up installation only)



Ballerina One Light Sconce

(1) 60W A19 max. / Medium Base
Dimensions: Width 15⁷/₈", Height 7", Extension 7⁷/₈"
60-5379 Mahogany Bronze / Frosted Glass
(glass up installation only)



Ballerina One Light Sconce

(1) 60W A19 max. / Medium Base
Dimensions: Width 15⁷/₈", Height 7", Extension 7⁷/₈"
60-5384 Mahogany Bronze / Champagne Glass
(glass up installation only)



Tapas One Light Sconce

(1) 60W A19 max. / Medium Base
Dimensions: Width 12", Height 7", Extension 6"
60-044 Old Bronze / Tuscan Suede Glass
(glass up installation only)



Empire One Light Sconce

(1) 60W A19 max. / Medium Base
Dimensions: Width 10", Height 9⁵/₈", Extension 5"
60-5376 Brushed Nickel / Alabaster Glass
(glass up installation only)



Empire One Light Sconce

(1) 60W A19 max. / Medium Base
Dimensions: Width 10", Height 9⁵/₈", Extension 5"
60-5377 Brushed Nickel / Frosted Glass
(glass up installation only)



Empire One Light Sconce

(1) 60W A19 max. / Medium Base
Dimensions: Width 10", Height 9⁵/₈", Extension 5"
60-5374 Old Bronze / Alabaster Glass
(glass up installation only)



Empire One Light Sconce

(1) 60W A19 max. / Medium Base
Dimensions: Width 10", Height 9⁵/₈", Extension 5"
60-5375 Mahogany Bronze / Frosted Glass
(glass up installation only)



Empire One Light Sconce

(1) 60W A19 max. / Medium Base
Dimensions: Width 10", Height 9⁵/₈", Extension 5"
60-5383 Mahogany Bronze / Champagne Glass
(glass up installation only)



Item#	Description	Finish	Light Source	Watts	Volts	Length	Width	Height	Ext.	CCT	Lumens	CRI	Cert. Type
62-1035	Glamour 10" Round	Brushed Nickel	LED	18	120	•	10"	3 ¾"	•	3000K	1,500*	90	Damp
62-1036	Glamour 13" Round	Brushed Nickel	LED	25	120	•	13"	3 ¾"	•	3000K	2,125*	90	Damp
62-1037	Glamour 17" Round	Brushed Nickel	LED	25	120	•	17"	3 ¾"	•	3000K	2,125*	90	Damp
62-1038	Glamour 24" Round	Brushed Nickel	LED	39	120	•	24"	3 ¾"	•	3000K	3,315*	90	Damp
62-1041	Glamour 10" Oval	Brushed Nickel	LED	52	120	32 ½"	18"	4"	•	3000K	4,420*	90	Damp

*Lumens measured at LED source.

** Consult Satco or visit www.satco.com for an up to date dimmer compatibility list.



Glamour LED flush fixtures

Even, consistent light.
Low maintenance.
High efficiency.

Applications

- Kitchen
- Bathroom
- Hallway
- Office
- Utility

Features

- Dimmable **
- 3000K
- Long Life – 30,000 hours
- Durable white polymer cover
- cETLus damp location
- 3 Year warranty



62-1041 (Oval)



62-1035



62-1036



62-1037



62-1038

Item#	Description	Finish	Light Source	Watts	Volts	Length	Width	Height	Ext.	CCT	Lumens	CRI	Cert. Type
62-1039	Glamour 25" Linear	Brushed Nickel	LED	26	120	25"	12"	4 ½"	•	3000K	2,210*	90	Damp
62-1040	Glamour 52" Linear	Brushed Nickel	LED	52	120	50"	12"	4 ½"	•	3000K	4,420*	90	Damp

*Lumens measured at LED source.

** Consult Satco or visit www.satco.com for an up to date dimmer compatibility list.



Glamour linear LED ceiling fixtures

Even, consistent light.
Low maintenance.
High efficiency.

Applications

- Kitchen
- Bathroom
- Hallway
- Office
- Utility

Features

- Dimmable **
- 3000K
- Long Life – 30,000 hours
- Durable white polymer lens
- cETLus damp location
- 3 Year warranty



62-1039



62-1040

Item#	Description	Finish	Light Source	Watts	Volts	Length	Width	Height	Ext.	CCT	Lumens	CRI	Cert. Type
62-1045	Glamour Wall Sconce	Brushed Nickel	LED	10	120	•	9"	10 1/2"	4"	3000K	850*	90	Damp

*Lumens measured at LED source. ** Consult Satco or visit www.satco.com for an up to date dimmer compatibility list.



**



Glamour LED wall sconces

Even, consistent light.
Low maintenance.
High efficiency.

Applications

- Kitchen
- Bathroom
- Hallway
- Office

Features

- Dimmable **
- 10 Watts – 75 Watt equivalent
- 3000K
- Long Life—30,000 hours
- Durable white polymer cover
- Damp location
- ADA Compliant
- cETLus damp location
- 3 Year warranty



62-1045

Item#	Description	Finish	Light Source	Watts	Volts	Length	Width	Height	Ext.	CCT	Lumens	CRI	Cert. Type
62-1031	Glamour 25" Vanity	Brushed Nickel	LED	26	120	•	25"	5 1/2"	3"	3000K	2,210*	90	Damp
62-1032	Glamour 49" Vanity	Brushed Nickel	LED	52	120	•	49"	5 1/2"	3"	3000K	4,420*	90	Damp

*Lumens measured at LED source.

** Consult Satco or visit www.satco.com for an up to date dimmer compatibility list.



Glamour LED vanity fixtures

Even, consistent light.
Low maintenance.
High efficiency.

Applications

- Kitchen
- Bathroom
- Hallway
- Office

Features

- Dimmable **
- 3000K
- Long Life—30,000 hours
- Durable white polymer lens
- Damp location
- ADA compliant
- cETLus damp location
- 3 Year warranty



62-1031



62-1032

Item#	Description	Finish	Light Source	Watts	Volts	Length	Width	Height	Ext.	CCT	Lumens	CRI	Cert. Type
62-1435	Glamour 10" Round	Black	LED	18	120	•	10"	3 ¾"	•	3000K	1,500*	90	Damp
62-1436	Glamour 13" Round	Black	LED	25	120	•	13"	3 ¾"	•	3000K	2,125*	90	Damp
62-1437	Glamour 17" Round	Black	LED	25	120	•	17"	3 ¾"	•	3000K	2,125*	90	Damp
62-1438	Glamour 24" Round	Black	LED	39	120	•	24"	3 ¾"	•	3000K	3,315*	90	Damp
62-1441	Glamour 10" Oval	Black	LED	52	120	32 ½"	18"	4"	•	3000K	4,420*	90	Damp

*Lumens measured at LED source.

** Consult Satco or visit www.satco.com for an up to date dimmer compatibility list.



Glamour LED flush fixtures

Even, consistent light.
Low maintenance.
High efficiency.

Applications

- Kitchen
- Bathroom
- Hallway
- Office
- Utility

Features

- Dimmable **
- 3000K
- Long Life – 30,000 hours
- Durable white polymer cover
- cETLus damp location
- 3 Year warranty



62-1441 (Oval)



62-1435



62-1436



62-1437



62-1438

Item#	Description	Finish	Light Source	Watts	Volts	Length	Width	Height	Ext.	CCT	Lumens	CRI	Cert. Type
62-1439	Glamour 25" Linear	Black	LED	26	120	25"	12"	4 ½"	•	3000K	2,210*	90	Damp
62-1440	Glamour 52" Linear	Black	LED	52	120	50"	12"	4 ½"	•	3000K	4,420*	90	Damp

*Lumens measured at LED source.

** Consult Satco or visit www.satco.com for an up to date dimmer compatibility list.



Glamour linear LED ceiling fixtures

Even, consistent light.
Low maintenance.
High efficiency.

Applications

- Kitchen
- Bathroom
- Hallway
- Office
- Utility

Features

- Dimmable **
- 3000K
- Long Life – 30,000 hours
- Durable white polymer lens
- cETLus damp location
- 3 Year warranty

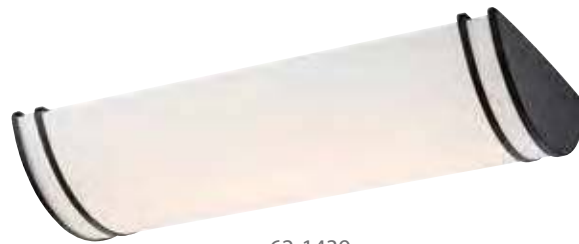

62-1439



62-1440

Item#	Description	Finish	Light Source	Watts	Volts	Length	Width	Height	Ext.	CCT	Lumens	CRI	Cert. Type
62-1445	Glamour Wall Sconce	Black	LED	10	120	•	9"	10 ½"	4"	3000K	850*	90	Damp
62-1046	Crispo Wall Sconce	White	LED	10	120	•	9"	10 ½"	4"	3000K	850*	90	Damp

*Lumens measured at LED source.

** Consult Satco or visit www.satco.com for an up to date dimmer compatibility list.



**



Glamour & Crispo LED wall sconces

Even, consistent light.
Low maintenance.
High efficiency.

Applications

- Kitchen
- Bathroom
- Hallway
- Office

Features

- Dimmable **
- 10 Watts – 75 Watt equivalent
- 3000K
- Long Life—30,000 hours
- Durable white polymer cover
- Damp location
- ADA Compliant
- cETLus damp location
- 3 Year warranty

Glamour



62-1445

Crispo



62-1046

Item#	Description	Finish	Light Source	Watts	Volts	Length	Width	Height	Ext.	CCT	Lumens	CRI	Cert. Type
62-1431	Glamour 25" Vanity	Black	LED	26	120	•	25"	5 ½"	3"	3000K	2,210*	90	Damp
62-1432	Glamour 49" Vanity	Black	LED	52	120	•	49"	5 ½"	3"	3000K	4,420*	90	Damp
62-1033	Crispo 25" Vanity	White	LED	26	120	•	25"	5 ½"	3"	3000K	2,210*	90	Damp
62-1034	Crispo 49" Vanity	White	LED	52	120	•	49"	5 ½"	3"	3000K	4,420*	90	Damp

*Lumens measured at LED source.

** Consult Satco or visit www.satco.com for an up to date dimmer compatibility list.



Glamour & Crispo LED vanity fixtures

Even, consistent light.
Low maintenance.
High efficiency.

Applications

- Kitchen
- Bathroom
- Hallway
- Office

Features

- Dimmable **
- 3000K
- Long Life—30,000 hours
- Durable white polymer lens
- Damp location
- ADA compliant
- cETLus damp location
- 3 Year warranty

Glamour



62-1431



62-1432

Crispo



62-1033



62-1034

Item#	Description	Finish	Light Source	Watts	Volts	Length	Width	Height	Ext.	CCT	Lumens	CRI	Cert. Type
62-745	11" Round	White	LED	16	120	•	11"	3 1/2"	•	3000K	990*	90	Damp
62-746	14" Round	White	LED	20	120	•	14"	3 1/2"	•	3000K	1,230*	90	Damp
62-765	19" Round	White	LED	32	120	•	19"	4 3/4"	•	3000K	1,950*	90	Damp
62-747	11" Round w/Occupancy Sensor	White	LED	16.5	120	•	11"	3 1/2"	•	3000K	990*	90	Damp
62-748	14" Round w/Occupancy Sensor	White	LED	20.5	120	•	14"	3 1/2"	•	3000K	1,230*	90	Damp
62-766	19" Round w/Occupancy Sensor	White	LED	32.5	120	•	19"	4 3/4"	•	3000K	1,950*	90	Damp

*Lumens measured at LED source.

** Consult Satco or visit www.satco.com for an up to date dimmer compatibility list.



11", 14" and 19" LED flush mount round fixtures with or without occupancy sensor

Applications

- Kitchen
- Bathroom
- Hallway
- Closets
- Office

Features

- Dimmable (without sensor only)**
- 11" – 75 Watt equivalent
- 14" – 100 Watt equivalent
- 19" – 150 Watt equivalent
- CCT: 3000K
- 90 CRI
- Long life – 50,000 hours
- Durable white cover (PMMA)
- cETLus damp location
- ENERGY STAR certified
- 5 Year warranty



62-746



LED module delivers
even light distribution



LED module and internal
occupancy sensor
(Functions through the outer lens)

Item#	Description	Finish	Light Source	Watts	Volts	Length	Width	Height	Ext.	CCT	Lumens	CRI	Cert. Type
62-1095	11" Square	White	LED	16	120	11"	11"	3 ¼"	•	3000K	990*	90	Damp
62-1096	14" Square	White	LED	20	120	14"	14"	3 ¼"	•	3000K	1,230*	90	Damp
62-1097	11" Square w/Occupancy Sensor	White	LED	16.5	120	11"	11"	3 ¼"	•	3000K	990*	90	Damp
62-1098	14" Square w/Occupancy Sensor	White	LED	20.5	120	14"	14"	3 ¼"	•	3000K	1,230*	90	Damp

*Lumens measured at LED source.

** Consult Satco or visit www.satco.com for an up to date dimmer compatibility list.



**



11" and 14" LED flush mount square fixtures with or without occupancy sensor

Applications

- Kitchen
- Bathroom
- Hallway
- Closets
- Office

Features

- Dimmable (without sensor only)**
- 11" – 75 Watt equivalent
- 14" – 100 Watt equivalent
- CCT: 3000K
- 90 CRI
- Long life – 50,000 hours
- Durable white cover (PMMA)
- cETLus damp location
- ENERGY STAR certified
- 5 Year warranty



62-1095, 62-1097



62-1096, 62-1098



LED module delivers even light distribution



LED module and internal occupancy sensor (Functions through the outer lens)

Item#	Description	Finish	Light Source	Watts	Volts	Length	Width	Height	Ext.	CCT	Lumens	CRI	Cert. Type
62-791†	11" Round 0-10V dimming	White	LED	12.5	120-277	•	11 5/8"	3 1/8"	•	3000K	875*	90	Damp
62-792†	14" Round 0-10V dimming	White	LED	16.5	120-277	•	14"	3 1/2"	•	3000K	1,170*	90	Damp
62-795R1††	11" Round	White	LED	12.5	120-277	•	11 5/8"	3 1/8"	•	3000K	890*	90	Damp
62-796R1††	14" Round	White	LED	16.5	120-277	•	14"	3 1/2"	•	3000K	1,120*	90	Damp

*Lumens measured at LED source.

** Consult Satco or visit www.satco.com for an up to date dimmer compatibility list.



11" and 14" Range voltage operation (120-277V) LED flush fixtures

Applications

- Kitchen
- Bathroom
- Hallway
- Closets
- Office

62-71, 62-792 0-10V Dimming Features

- Dimmable (0-10V)†
- Over 80% energy savings
- CCT: 3000K
- 90 CRI
- Long life – 50,000 hours
- Durable white cover (PMMA)
- ENERGY STAR certified†
- 5 Year warranty

62-795R1, 62-796R1 Features

- Dimmable (120V only)††
- Over 80% energy savings
- CCT: 3000K
- 90 CRI
- Long life – 40,000 hours
- Durable white cover (PMMA)
- ENERGY STAR certified
- 5 Year warranty



62-791, 62-795R1



62-792, 62-796R1

Item#	Description	Finish	Light Source	Watts	Volts	Length	Width	Height	Ext.	CCT	Lumens	CRI	Cert. Type
62-797	14" Round w/Occupancy Sensor	White	LED	16.5	120-277	•	14"	3 1/2"	•	3000K	960*	90	Damp
62-798	14" Round w/Step Down Sensor	White	LED	16.5	120-277	•	14"	3 1/2"	•	3000K	960*	90	Damp

*Lumens measured at LED source.

** Consult Satco or visit www.satco.com for an up to date dimmer compatibility list.



14" Range voltage operation (120-277V) LED flush fixtures with sensors

Applications

- Kitchen
- Bathroom
- Hallway
- Closets
- Office

62-797 Occupancy Sensor Features

- Occupancy Sensor—provides automatic ON/OFF switching
- Over 80% energy savings
- Damp location
- Durable polymer cover
- ENERGY STAR certified†
- 5 Year warranty

62-798 Vacancy Sensor Features

- 24/7 Sensor step-down operation:
Unoccupied, 50% light / occupied, 100% light (Always on)
- Over 80% energy savings
- Damp location
- Durable white cover (PMMA)
- ENERGY STAR certified
- 5 Year warranty



Item#	Description	Finish	Light Source	Watts	Volts	Length	Width	Height	Ext.	CCT	Lumens	CRI	Cert. Type
62-991	14" Round EMR Flush	White	LED	20	120-277	•	14"	4 3/4"	•	3000K	1,300*	90	Damp†

*Lumens measured at LED source.

** Consult Satco or visit www.satco.com for an up to date dimmer compatibility list.
†Not suitable for damp locations if used with optional battery back-up module.



**



14" LED flush mount

Emergency battery back-up ready (EMR).

Applications

- Kitchens
- Bedrooms
- Baths
- Hallways
- Stairwells
- Office

Features

- 100W equivalent
- 20 Watts—over 80% energy savings
- 120–277V, 50/60Hz
- High color rendition (CRI 90+)
- Dimmable – 120V
- Dimming range: 20% -100%
- Damp location†
- Operating temperature: -17°C to 45°C
- White finish with durable white cover (PMMA)
- 5 Year warranty

Battery back-up ready (EMR).
Indicator light and test button
Included with battery back-up disk
(sold separately).



Emergency battery back-up disk (not included)



The emergency battery back-up disk, Satco model S9299 (120V) or Satco model S9780 (277V) (not included), easily mounts inside the pan of this fixture (below).
S9299
S9780



Replacement battery -
26F18650
2600 mAh, 5.2A



Integrated circular LED module for consistency and dependability.

Item#	Description	Finish	Light Source	Watts	Volts	Length	Width	Height	Ext.	CCT	Lumens	CRI	Cert. Type
65-1101	4' Non Linkable Strip Fixture	White	LED	24	120-277	46 1/2"	46 1/2"	1 1/2"	•	4000K	1,800*	90	Damp
65-1102	1' Linkable Strip Fixture	White	LED	12	120	12 1/8"	12 1/8"	1 5/8"	•	4000K	840*	90	Damp
65-1103	2' Linkable Strip Fixture	White	LED	24	120	22 3/4"	22 3/4"	1 5/8"	•	4000K	1,680*	90	Damp
65-1104	4' Linkable Strip Fixture	White	LED	36	120	46 1/2"	46 1/2"	1 5/8"	•	4000K	2,600*	90	Damp

*Lumens measured at LED source.



LED strip fixtures

Even, consistent light.
Low maintenance.
High efficiency.

Applications

- Bathrooms
- Closets
- Kitchen
- Work areas
- Hallways
- Retail

Features

- 4' Stand-alone model
- 1', 2', and 4' Connectable models
- Ceiling or wall mount
- Maintenance free—no bulb to change
- Consistent, even light distribution
- 90 CRI
- Ultra-slim design
- Damp location rated
- 4000K
- 50,000 hour life
- ENERGY STAR certified
- 5 Year warranty

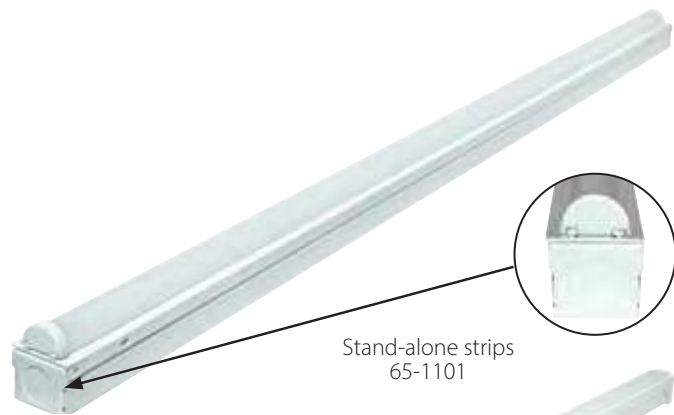

Stand-alone strips
65-1101

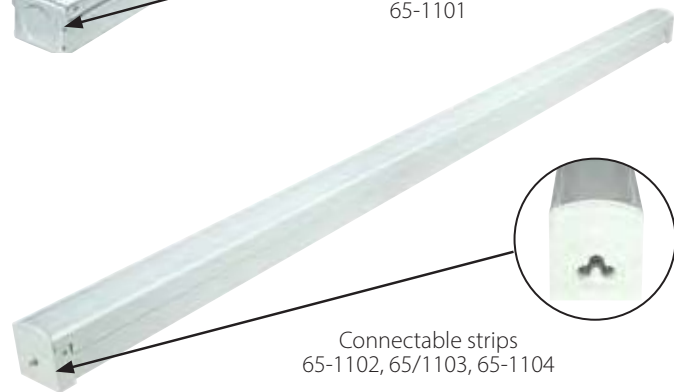

Connectable strips
65-1102, 65-1103, 65-1104

Accessories



65-1107
5' Power cord



65-1108
8" Connector

Item#	Description	Finish	Light Source	Watts	Volts	Length	Width	Height	Ext.	CCT	Lumens	CRI	Cert. Type
65-1081	2' Ceiling Wrap	White	LED	20	100-277	24 1/2"	5 1/2"	2 5/8"	•	4000K	1,600*	90	Damp
65-1082	4' Ceiling Wrap	White	LED	40	100-277	47 1/2"	5 1/2"	2 5/8"	•	4000K	3,200*	90	Damp
65-1083	2' Ceiling Wrap	White	LED	20	100-277	24 1/2"	5 1/2"	2 5/8"	•	3000K	1,600*	90	Damp
65-1084	4' Ceiling Wrap	White	LED	40	100-277	47 1/2"	5 1/2"	2 5/8"	•	3000K	3,200*	90	Damp

*Lumens measured at LED source.



LED ceiling wraps

Applications

- Kitchens
- Work areas
- Hallways
- Laundry
- Closets

Features

- 2' and 4' Lengths
- Mounts directly to junction box or can be internally wired using built-in junction box
- Maintenance free – no bulb to change
- Perfect, even light distribution
- 90 CRI
- Slim design
- 50,000 hour life
- Universal input voltage, 100-277V
- 3000K & 4000K options
- Certified for damp locations
- ENERGY STAR certified
- 5 Year warranty



65-1081, 65-1083

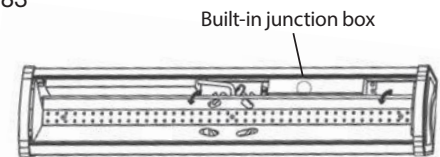

Built-in junction box

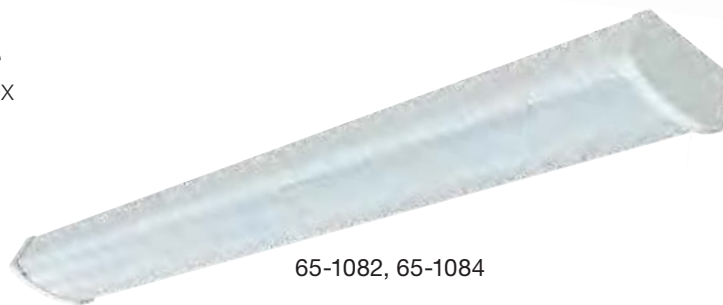

65-1082, 65-1084

Item#	Description	Finish	Light Source	Watts	Volts	Length	Width	Height	Ext.	CCT	Lumens	CRI	Cert. Type
65-1091	2' Ceiling Wrap with Pull Chain	White	LED	20	120	24 1/2"	5 1/2"	1 5/8"	•	3000K	1,600*	90	Damp
65-1092	4' Ceiling Wrap with Pull Chain	White	LED	20	120	47 1/2"	5 1/2"	1 5/8"	•	3000K	3,200*	90	Damp
65-1095	2' Ceiling Wrap with Motion Sensor	White	LED	20	100-277	24 1/2"	5 1/2"	1 5/8"	•	4000K	1,600*	90	Damp
65-1096	4' Ceiling Wrap with Motion Sensor	White	LED	20	100-277	47 1/2"	5 1/2"	1 5/8"	•	4000K	3,200*	90	Damp
65-1097	2' Ceiling Wrap with Motion Sensor	White	LED	20	100-277	24 1/2"	5 1/2"	1 5/8"	•	3000K	1,600*	90	Damp
65-1098	4' Ceiling Wrap with Motion Sensor	White	LED	20	100-277	47 1/2"	5 1/2"	1 5/8"	•	3000K	3,200*	90	Damp

*Lumens measured at LED source.



LED ceiling wraps with pull chain or motion sensor

Applications

- Kitchens
- Work areas
- Hallways
- Laundry
- Closets

Features

- 2' and 4' Lengths
- With on-off pull chain or sensor
- Mounts directly to junction box or can be internally wired using built-in junction box
- Maintenance free – no bulb to change
- Perfect, even light distribution
- 90 CRI
- Slim design
- 50,000 hour life
- Universal input voltage, 100-277V (Pull chain 120V only)
- 3000K & 4000K options
- Certified for damp locations
- ENERGY STAR certified
- 5 Year warranty

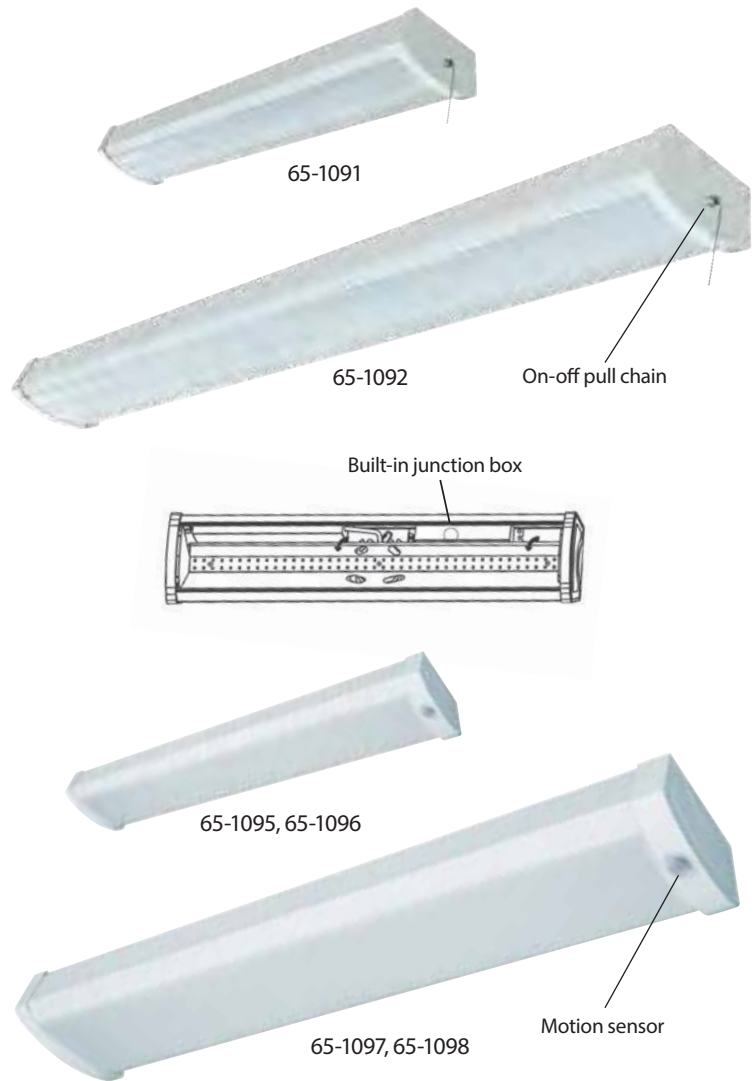

PIR Sensor specifications:

- Ceiling mounted installation - ceiling height 2.2-4m / 7'-13'
- Detection Distance: 4-6m / 13'-20'
- No Detection Shut Off Time: 50 Seconds

Item#	Description	Finish	Light Source	Watts	Volts	Length	Width	Height	Ext.	CCT	Lumens	CRI	Cert. Type
62-1151†	1' x 1' Flush	White	LED	18	100-277	12"	12"	¾"	•	5000K	1,600*	80	Damp
62-1153†	2' x 2' Flush	White	LED	45	100-277	24"	24"	¾"	•	5000K	4,050*	80	Damp
62-1051†	1' x 1' Flush	White	LED	18	100-277	12"	12"	¾"	•	3000K	1,300*	90	Damp
62-1251†	1' x 1' Flush	White	LED	18	100-277	12"	12"	¾"	•	4000K	1,365*	90	Damp
62-1053†	2' x 2' Flush	White	LED	45	100-277	24"	24"	¾"	•	3000K	3,500*	90	Damp
62-1253†	2' x 2' Flush	White	LED	45	100-277	24"	24"	¾"	•	4000K	3,675*	90	Damp

*Lumens measured at LED source.

** Consult Satco or visit www.satco.com for an up to date dimmer compatibility list.



1' x 1' and 2' x 2' Blink™ Plus LED surface mount fixtures

Applications

- Kitchens
- Bathrooms
- Hallways
- Meeting rooms
- Hospitality
- Health care
- Offices
- Retail

Features

- Dimmable, 120V only**
- White finish
- Damp location
- Ultra-low profile made for j-box installs
- Unique quick-lock mounting bracket
- Mounts directly to 3" and 4" junction boxes
- 100-277V
- ENERGY STAR certified†
- 5 Year limited warranty



62-1151



Installation for 2'x2' fixtures is easy using the unique quick-lock mounting bracket.



Quick-lock mounting bracket for all 1'x1' fixtures.

Item#	Description	Finish	Light Source	Watts	Volts	Length	Width	Height	Ext.	CCT	Lumens	CRI	Cert. Type
62-1152	1' x 2' Flush	White	LED	22	100-277	24"	12"	¾"	•	5000K	1,900*	80	Damp
62-1052†	1' x 2' Flush	White	LED	22	100-277	24"	12"	¾"	•	3000K	1,650*	90	Damp
62-1252†	1' x 2' Flush	White	LED	22	100-277	24"	12"	¾"	•	4000K	1,735*	90	Damp

*Lumens measured at LED source.

** Consult Satco or visit www.satco.com for an up to date dimmer compatibility list.



1' x 2' Blink™ Plus LED surface mount fixtures

Applications

- Kitchens
- Bathrooms
- Hallways
- Meeting rooms
- Hospitality
- Health care
- Offices
- Retail

Features

- Dimmable, 120V only**
- White finish
- Damp location
- Ultra-low profile made for j-box installs
- Unique quick-lock mounting bracket
- Mounts directly to 3" and 4" junction boxes
- 100-277V
- ENERGY STAR certified†
- 5 Year limited warranty



Unique quick-lock mounting bracket.

Item#	Description	Finish	Light Source	Watts	Volts	Length	Width	Height	Ext.	CCT	Lumens	CRI	Cert. Type
62-1154	1' x 4' Flush	White	LED	45	100-277	48"	12"	¾"	•	5000K	4,050*	80	Damp
62-1054†	1' x 4' Flush	White	LED	45	100-277	48"	12"	¾"	•	3000K	3,600*	90	Damp
62-1254†	1' x 4' Flush	White	LED	45	100-277	48"	12"	¾"	•	4000K	3,780*	90	Damp

*Lumens measured at LED source.

** Consult Satco or visit www.satco.com for an up to date dimmer compatibility list.



1' x 4' Blink™ Plus LED surface mount fixtures

Applications

- Kitchens
- Bathrooms
- Hallways
- Meeting rooms
- Hospitality
- Health care
- Offices
- Retail

Features

- Dimmable, 120V only**
- White finish
- Damp location
- Ultra-low profile made for j-box installs
- Unique quick-lock mounting bracket
- Mounts directly to 3" and 4" junction boxes
- 100-277V
- ENERGY STAR certified†
- 5 Year limited warranty



Unique quick-lock mounting bracket.

Item#	Description	Finish	Light Source	Watts	Volts	Length	Width	Height	Ext.	CCT	Lumens	CRI	Cert. Type
62-1155	5 1/2" x 24" Flush	White	LED	22	100-277	24"	5 1/2"	3/4"	•	5000K	1,870*	80	Damp
62-1156	5 1/2" x 36" Flush	White	LED	30	100-277	36"	5 1/2"	3/4"	•	5000K	2,600*	80	Damp
62-1157	5 1/2" x 48" Flush	White	LED	40	100-277	48"	5 1/2"	3/4"	•	5000K	3,300*	80	Damp
62-1055†	5 1/2" x 24" Flush	White	LED	22	100-277	24"	5 1/2"	3/4"	•	3000K	1,600*	90	Damp
62-1056†	5 1/2" x 36" Flush	White	LED	30	100-277	36"	5 1/2"	3/4"	•	3000K	2,100*	90	Damp
62-1057†	5 1/2" x 48" Flush	White	LED	40	100-277	48"	5 1/2"	3/4"	•	3000K	2,800*	90	Damp
62-1255†	5 1/2" x 24" Flush	White	LED	22	100-277	24"	5 1/2"	3/4"	•	4000K	1,680*	90	Damp
62-1256†	5 1/2" x 36" Flush	White	LED	30	100-277	36"	5 1/2"	3/4"	•	4000K	2,205*	90	Damp
62-1257†	5 1/2" x 48" Flush	White	LED	40	100-277	48"	5 1/2"	3/4"	•	4000K	2,940*	90	Damp

*Lumens measured at LED source.

** Consult Satco or visit www.satco.com for an up to date dimmer compatibility list.



Blink™ Plus LED linear surface mount fixtures

Applications

- Kitchens
- Bathrooms
- Hallways
- Meeting rooms
- Hospitality
- Health care
- Offices
- Retail

Features

- Dimmable, 120V only**
- White finish
- Damp location
- Ultra-low profile made for j-box installs
- Unique quick-lock mounting bracket
- Mounts directly to 3" and 4" junction boxes
- 100-277V
- ENERGY STAR certified†
- 5 Year limited warranty



Lengths:

- 24"
- 36"
- 48"



Unique quick-lock mounting bracket.

Item#	Description	Finish	Light Source	Watts	Volts	Length	Width	Height	Ext.	CCT	Lumens	CRI	Cert. Type
62-1171†	1' x 1' Flush	Gunmetal	LED	18	100-277	12"	12"	1"	•	3000K	1,300*	90	Damp
62-1173†	2' x 2' Flush	Gunmetal	LED	45	100-277	24"	24"	1"	•	3000K	3,500*	90	Damp
62-1181†	1' x 1' Flush	Bronze	LED	18	100-277	12"	12"	1"	•	3000K	1,300*	90	Damp
62-1183†	2' x 2' Flush	Bronze	LED	45	100-277	24"	24"	1"	•	3000K	3,500*	90	Damp
62-1371†	1' x 1' Flush	White	LED	18	100-277	12"	12"	1"	•	3000K	1,300*	90	Damp
62-1373†	2' x 2' Flush	White	LED	45	100-277	24"	24"	1"	•	3000K	3,500*	90	Damp
62-1381†	1' x 1' Flush	White	LED	18	100-277	12"	12"	1"	•	4000K	1,365*	90	Damp
62-1383†	2' x 2' Flush	White	LED	45	100-277	24"	24"	1"	•	4000K	3,780*	90	Damp

*Lumens measured at LED source.

** Consult Satco or visit www.satco.com for an up to date dimmer compatibility list.



1' x 1' and 2' x 2' Blink™ Plus Profile LED surface mount fixtures

Applications

- Kitchens • Bathrooms • Hallways
- Meeting rooms • Hospitality • Health care
- Offices • Retail • Closets

Features

- Dimmable, 120V only**
- White, Gunmetal or Bronze finish
- Damp location listed
- Ultra-low profile only 1" deep
- Unique quick-lock mounting bracket
- Mounts directly to 3" and 4" junction boxes
- 100-277V
- 90 CRI
- ENERGY STAR certified†
- 5 Year limited warranty



Bronze Finish
62-1181 1'x1'



Gunmetal Finish
62-1171 1'x1'



Installation is easy using the unique quick-lock mounting brackets for (2' x 2').



Quick-lock mounting bracket for (1' x 1').

Item#	Description	Finish	Light Source	Watts	Volts	Length	Width	Height	Ext.	CCT	Lumens	CRI	Cert. Type
62-1172†	1' x 1' Flush	Gunmetal	LED	22	100-277	12"	24"	1"	•	3000K	1,650*	90	Damp
62-1174†	2' x 2' Flush	Gunmetal	LED	45	100-277	12"	48"	1"	•	3000K	3,600*	90	Damp
62-1182†	1' x 1' Flush	Bronze	LED	22	100-277	12"	24"	1"	•	3000K	1,650*	90	Damp
62-1184†	2' x 2' Flush	Bronze	LED	45	100-277	12"	48"	1"	•	3000K	3,600*	90	Damp
62-1372†	1' x 1' Flush	White	LED	22	100-277	12"	24"	1"	•	3000K	1,650*	90	Damp
62-1374†	2' x 2' Flush	White	LED	45	100-277	12"	48"	1"	•	3000K	3,600*	90	Damp
62-1382†	1' x 1' Flush	White	LED	22	100-277	12"	24"	1"	•	4000K	1,735*	90	Damp
62-1384†	2' x 2' Flush	White	LED	45	100-277	12"	48"	1"	•	4000K	3,780*	90	Damp

*Lumens measured at LED source.

** Consult Satco or visit www.satco.com for an up to date dimmer compatibility list.



1' x 2' and 1' x 4' Blink™ Plus Profile LED surface mount fixtures

Applications

- Kitchens • Bathrooms • Hallways
- Meeting rooms • Hospitality • Health care
- Offices • Retail • Closets

Features

- Dimmable, 120V only**
- White, Gunmetal or Bronze finish
- Damp location listed
- Ultra-low profile only 1" deep
- Unique quick-lock mounting bracket
- Mounts directly to 3" and 4" junction boxes
- 100-277V
- 90 CRI
- ENERGY STAR certified†
- 5 Year limited warranty



Bronze Finish
62-1172 1'x2'



Gunmetal Finish
62-1184 1'x4'



Installation is easy using the unique quick-lock mounting brackets.

Item#	Description	Finish	Light Source	Watts	Volts	Length	Width	Height	Ext.	CCT	Lumens	CRI	Cert. Type
62-1175†	7" x 25" Flush	Gunmetal	LED	22	100-277	25"	7"	1"	•	3000K	1,600*	90	Damp
62-1176†	7" x 38" Flush	Gunmetal	LED	30	100-277	38"	7"	1"	•	3000K	2,100*	90	Damp
62-1177†	7" x 49" Flush	Gunmetal	LED	40	100-277	49"	7"	1"	•	3000K	2,800*	90	Damp
62-1185†	7" x 25" Flush	Bronze	LED	22	100-277	25"	7"	1"	•	3000K	1,600*	90	Damp
62-1186†	7" x 38" Flush	Bronze	LED	30	100-277	38"	7"	1"	•	3000K	2,100*	90	Damp
62-1187†	7" x 49" Flush	Bronze	LED	40	100-277	49"	7"	1"	•	3000K	2,800*	90	Damp
62-1375†	7" x 25" Flush	White	LED	22	100-277	25"	7"	1"	•	3000K	1,600*	90	Damp
62-1376†	7" x 38" Flush	White	LED	30	100-277	38"	7"	1"	•	3000K	2,100*	90	Damp
62-1377†	7" x 49" Flush	White	LED	40	100-277	49"	7"	1"	•	3000K	2,800*	90	Damp
62-1385†	7" x 25" Flush	White	LED	22	100-277	25"	7"	1"	•	4000K	1,680*	90	Damp
62-1386†	7" x 38" Flush	White	LED	30	100-277	38"	7"	1"	•	4000K	2,205*	90	Damp
62-1387†	7" x 49" Flush	White	LED	40	100-277	49"	7"	1"	•	4000K	2,940*	90	Damp

*Lumens measured at LED source.

** Consult Satco or visit www.satco.com for an up to date dimmer compatibility list.



Blink™ Plus Profile LED linear surface mount fixtures

Applications

- Kitchens • Bathrooms • Hallways
- Meeting rooms • Hospitality • Health care
- Offices • Retail • Closets

Features

- Dimmable, 120V only**
- White, Gunmetal or Bronze finish
- Damp location listed
- Ultra-low profile only 1" deep
- Unique quick-lock mounting bracket
- Mounts directly to 3" and 4" junction boxes
- 100-277V
- 90 CRI
- ENERGY STAR certified†
- 5 Year limited warranty



Bronze Finish
62-1187 49"x7"



Installation is easy using the unique quick-lock mounting brackets.

Item#	Description	Finish	Light Source	Watts	Volts	Length	Width	Height	Ext.	CCT	Lumens	CRI	Cert. Type
62-1191†	15" Round Flush	White	LED	26	100-277	•	15"	1"	•	3000K	2,000*	80	Damp
62-1192†	15" Round Flush	White	LED	26	100-277	•	15"	1"	•	3000K	2,100*	80	Damp
62-1291†	19" Round Flush	White	LED	30	100-277	•	19"	1"	•	3000K	2,400*	90	Damp
62-1292†	19" Round Flush	White	LED	30	100-277	•	19"	1"	•	3000K	2,520*	90	Damp

*Lumens measured at LED source.

** Consult Satco or visit www.satco.com for an up to date dimmer compatibility list.

Item#	Description	Finish	Cable	Wire
62-1294	15" Blink Plus Round Fixture Suspension Kit	White	(3) 12 Foot suspension cables	12' Wire
62-1295	19" Blink Plus Round Fixture Suspension Kit	White	(3) 12 Foot suspension cables	12' Wire



Blink™ Plus 15" and 19" LED surface mount fixtures

Applications

- Kitchens • Bathrooms • Hallways
- Meeting rooms • Hospitality • Health care
- Offices • Retail • Closets

Features

- Dimmable, 120V only**
- White finish
- Damp location listed
- Ultra-low profile only 1" deep
- Unique quick-lock mounting bracket
- Mounts directly to 3" and 4" junction boxes
- 100-277V
- 90 CRI
- ENERGY STAR certified†
- 5 Year limited warranty

Blink™ Plus 15" and 19" fixture suspension kits

Features

- For use with Blink Plus 15" and 19" round LED fixtures
- White finish
- Includes 12' of wire
- Includes (3) 12' suspension cables
- Fixtures not included



62-1191



62-1192



Quick-lock mounting bracket for Blink Plus 15" & 19" fixtures



62-1295
19" Suspension Kit
(Fixture sold separately)



62-1294
15" Suspension Kit
(Fixture sold separately)

Item#	Description	Finish	Light Source	Watts	Volts	Length	Width	Height	Ext.	CCT	Lumens	CRI	Cert. Type
S29320	5 1/2" Round	White	LED	10.5	120	•	5 1/2"	1"	•	2700K	580*	90	Wet
S29321	5 1/2" Round	Brushed Nickel	LED	10.5	120	•	5 1/2"	1"	•	2700K	580*	90	Wet
S29322	5 1/2" Round	Bronze	LED	10.5	120	•	5 1/2"	1"	•	2700K	580*	90	Wet
S29323	5 1/2" Round	White	LED	10.5	120	•	5 1/2"	1"	•	3000K	600*	90	Wet
S29359	5 1/2" Round	Brushed Nickel	LED	10.5	120	•	5 1/2"	1"	•	3000K	600*	90	Wet
S21500	5 1/2" Round	Bronze	LED	10.5	120	•	5 1/2"	1"	•	3000K	600*	90	Wet
S21501	5 1/2" Round	White	LED	10.5	120	•	5 1/2"	1"	•	4000K	600*	90	Wet
S21502	5 1/2" Round	White	LED	10.5	120	•	5 1/2"	1"	•	5000K	600*	80	Wet

*Lumens measured at LED source.

** Consult Satco or visit www.satco.com for an up to date dimmer compatibility list.



5.5" Round Blink™ LED fixtures

Applications

- Kitchens
- Bathrooms
- Hallways
- Family rooms
- Offices

Features

- Dimmable**
- Wet location listed
- 108° Beam angle
- Available in White, Brushed Nickel, and Bronze
- Mounts directly to 3" and 4" junction boxes
- ENERGY STAR certified
- 5 Year limited warranty



White



Brushed Nickel



Bronze

Item#	Description	Finish	Light Source	Watts	Volts	Length	Width	Height	Ext.	CCT	Lumens	CRI	Cert. Type
S29324	5 1/2" Square	White	LED	10.5	120	5 1/2"	5 1/2"	1"	•	2700K	580*	90	Wet
S29325	5 1/2" Square	Brushed Nickel	LED	10.5	120	5 1/2"	5 1/2"	1"	•	2700K	580*	90	Wet
S29326	5 1/2" Square	Bronze	LED	10.5	120	5 1/2"	5 1/2"	1"	•	2700K	580*	90	Wet
S29327	5 1/2" Square	White	LED	10.5	120	5 1/2"	5 1/2"	1"	•	3000K	600*	90	Wet
S21503	5 1/2" Square	Brushed Nickel	LED	10.5	120	5 1/2"	5 1/2"	1"	•	3000K	600*	90	Wet
S21504	5 1/2" Square	Bronze	LED	10.5	120	5 1/2"	5 1/2"	1"	•	3000K	600*	90	Wet
S21505	5 1/2" Square	White	LED	10.5	120	5 1/2"	5 1/2"	1"	•	4000K	600*	90	Wet
S21506	5 1/2" Square	White	LED	10.5	120	5 1/2"	5 1/2"	1"	•	5000K	600*	80	Wet

*Lumens measured at LED source.

** Consult Satco or visit www.satco.com for an up to date dimmer compatibility list.



5.5" Square Blink™ LED fixtures

Applications

- Kitchens
- Bathrooms
- Hallways
- Family rooms
- Offices

Features

- Dimmable**
- Wet location listed
- 108° Beam angle
- Available in White, Brushed Nickel, and Bronze
- Mounts directly to 3" and 4" junction boxes
- ENERGY STAR certified
- 5 Year limited warranty



White



Brushed Nickel

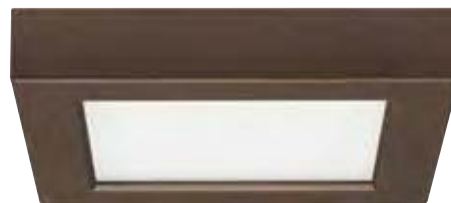

Bronze

Item#	Description	Finish	Light Source	Watts	Volts	Length	Width	Height	Ext.	CCT	Lumens	CRI	Cert. Type
S29328	7" Round	White	LED	13.5	120	•	7"	1"	•	2700K	800*	90	Wet
S29329	7" Round	Brushed Nickel	LED	13.5	120	•	7"	1"	•	2700K	800*	90	Wet
S29330	7" Round	Bronze	LED	13.5	120	•	7"	1"	•	2700K	800*	90	Wet
S29331	7" Round	White	LED	13.5	120	•	7"	1"	•	3000K	820*	90	Wet
S29349	7" Round	Brushed Nickel	LED	13.5	120	•	7"	1"	•	3000K	820*	90	Wet
S21507	7" Round	Bronze	LED	13.5	120	•	7"	1"	•	3000K	820*	90	Wet
S29655	7" Round	White	LED	13.5	120	•	7"	1"	•	4000K	820*	90	Wet
S29360	7" Round	White	LED	13.5	120	•	7"	1"	•	5000K	900*	90	Wet
S29367	7" Round 0-10V	White	LED	13.5	120	•	7"	1"	•	3000K	820*	90	Wet
S21508	7" Round 0-10V	White	LED	13.5	120	•	7"	1"	•	4000K	820*	80	Wet
S29357	7" Round 0-10V 277V	White	LED	13.5	277	•	7"	1"	•	3000K	820*	90	Wet

*Lumens measured at LED source.

** Consult Satco or visit www.satco.com for an up to date dimmer compatibility list.



7" Round Blink™ LED fixtures

Applications

- Kitchens
- Bathrooms
- Hallways
- Family rooms
- Offices

Features

- Dimmable**
- Wet location listed
- 108° Beam angle
- Available in White, Brushed Nickel, and Bronze
- Mounts directly to 3" and 4" junction boxes
- ENERGY STAR certified
- 5 Year limited warranty



White



Brushed Nickel



Bronze

Item#	Description	Finish	Light Source	Watts	Volts	Length	Width	Height	Ext.	CCT	Lumens	CRI	Cert. Type
S29332	7" Square	White	LED	13.5	120	7"	7"	1"	•	2700K	780*	90	Wet
S29333	7" Square	Brushed Nickel	LED	13.5	120	7"	7"	1"	•	2700K	780*	90	Wet
S29334	7" Square	Bronze	LED	13.5	120	7"	7"	1"	•	2700K	780*	90	Wet
S29335	7" Square	White	LED	13.5	120	7"	7"	1"	•	3000K	800*	90	Wet
S21509	7" Square	Brushed Nickel	LED	13.5	120	7"	7"	1"	•	3000K	800*	90	Wet
S21510	7" Square	Bronze	LED	13.5	120	7"	7"	1"	•	3000K	800*	90	Wet
S21511	7" Square	White	LED	13.5	120	7"	7"	1"	•	4000K	800*	90	Wet
S29361†	7" Square	White	LED	13.5	120	7"	7"	1"	•	5000K	880*	80	Wet

*Lumens measured at LED source.

** Consult Satco or visit www.satco.com for an up to date dimmer compatibility list.



7" Square Blink™ LED fixtures

Applications

- Kitchens
- Bathrooms
- Hallways
- Family rooms
- Offices

Features

- Dimmable**
- Wet location listed
- 108° Beam angle
- Available in White, Brushed Nickel, and Bronze
- Mounts directly to 3" and 4" junction boxes
- ENERGY STAR certified
- 5 Year limited warranty



White



Brushed Nickel



Bronze

Item#	Description	Finish	Light Source	Watts	Volts	Length	Width	Height	Ext.	CCT	Lumens	CRI	Cert. Type
S29336	9" Round	White	LED	18.5	120	•	9"	1"	•	2700K	1,150*	90	Wet
S29337	9" Round	Brushed Nickel	LED	18.5	120	•	9"	1"	•	2700K	1,150*	90	Wet
S29338	9" Round	Bronze	LED	18.5	120	•	9"	1"	•	2700K	1,150*	90	Wet
S29339	9" Round	White	LED	18.5	120	•	9"	1"	•	3000K	1,200*	90	Wet
S29379	9" Round	Brushed Nickel	LED	18.5	120	•	9"	1"	•	3000K	1,200*	90	Wet
S21512	9" Round	Bronze	LED	18.5	120	•	9"	1"	•	3000K	1,200*	90	Wet
S29690	9" Round	White	LED	18.5	120	•	9"	1"	•	4000K	1,200*	90	Wet
S29362	9" Round	White	LED	18.5	120	•	9"	1"	•	5000K	1,300*	80	Wet
S21513	9" Round 0-10V	White	LED	18.5	120	•	9"	1"	•	3000K	1,200*	90	Wet
S21514	9" Round 0-10V	White	LED	18.5	120	•	9"	1"	•	4000K	1,300*	90	Wet
S29358	9" Round 0-10V 277V	White	LED	18.5	277	•	9"	1"	•	3000K	1,200*	90	Wet

*Lumens measured at LED source.

** Consult Satco or visit www.satco.com for an up to date dimmer compatibility list.



9" Round Blink™ LED fixtures

Applications

- Kitchens
- Bathrooms
- Hallways
- Family rooms
- Offices

Features

- Dimmable**
- Wet location listed
- 108° Beam angle
- Available in White, Brushed Nickel, and Bronze
- Mounts directly to 3" and 4" junction boxes
- ENERGY STAR certified
- 5 Year limited warranty



White



Brushed Nickel



Bronze

Item#	Description	Finish	Light Source	Watts	Volts	Length	Width	Height	Ext.	CCT	Lumens	CRI	Cert. Type
S29340	9" Square	White	LED	18.5	120	9"	9"	1"	•	2700K	1,100*	90	Wet
S29341	9" Square	Brushed Nickel	LED	18.5	120	9"	9"	1"	•	2700K	1,100*	90	Wet
S29342	9" Square	Bronze	LED	18.5	120	9"	9"	1"	•	2700K	1,100*	90	Wet
S29343	9" Square	White	LED	18.5	120	9"	9"	1"	•	3000K	1,150*	90	Wet
S21515	9" Square	Brushed Nickel	LED	18.5	120	9"	9"	1"	•	3000K	1,150*	90	Wet
S21516	9" Square	Bronze	LED	18.5	120	9"	9"	1"	•	3000K	1,150*	90	Wet
S21517	9" Square	White	LED	18.5	120	9"	9"	1"	•	4000K	1,200*	90	Wet
S29363	9" Square	White	LED	18.5	120	9"	9"	1"	•	5000K	1,350*	80	Wet

*Lumens measured at LED source.

** Consult Satco or visit www.satco.com for an up to date dimmer compatibility list.



9" Square Blink™ LED fixtures

Applications

- Kitchens
- Bathrooms
- Hallways
- Family rooms
- Offices

Features

- Dimmable**
- Wet location listed
- 108° Beam angle
- Available in White, Brushed Nickel, and Bronze
- Mounts directly to 3" and 4" junction boxes
- ENERGY STAR certified
- 5 Year limited warranty



White



Brushed Nickel

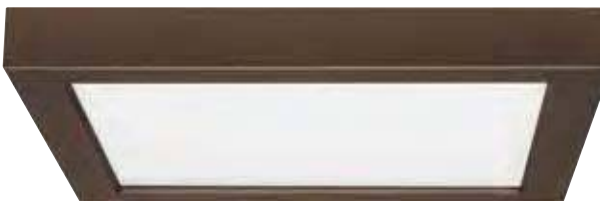

Bronze

Item#	Description	Finish	Light Source	Watts	Volts	Length	Width	Height	Ext.	CCT	Lumens	CRI	Cert. Type
S29650	13" Round	White	LED	24	120	•	13"	1"	•	3000K	1,500*	90	Wet
S29651	13" Round	Brushed Nickel	LED	24	120	•	13"	1"	•	3000K	1,500*	90	Wet
S29652	13" Round	Bronze	LED	24	120	•	13"	1"	•	3000K	1,500*	90	Wet
S29691	13" Round	White	LED	25	120	•	13"	1"	•	4000K	1,800*	80	Wet

*Lumens measured at LED source.

** Consult Satco or visit www.satco.com for an up to date dimmer compatibility list.



**



13" Round Blink™ LED fixtures

Applications

- Kitchens
- Bathrooms
- Hallways
- Family rooms
- Offices

Features

- Dimmable**
- Wet location listed
- 108° Beam angle
- Available in White, Brushed Nickel, and Bronze
- Mounts directly to 3" and 4" junction boxes
- ENERGY STAR certified
- 5 Year limited warranty



White



Brushed Nickel



Bronze



Installation is easy using the twist & lock mounting bracket.

Item#	Description	Color
S29344	7" Round Battery Back Up	White
S29346	7" Round Battery Back Up – Empty Casing*	White
S29653	7" Round Battery Back Up	Brushed Nickel
S29654	7" Round Battery Back Up – Empty Casing*	Brushed Nickel
S29345	7" Square Battery Back Up	White
S29347	7" Square Battery Back Up – Empty Casing*	White

* Used to maintain consistent appearance with Blinks utilizing the battery back up.

Blink™ 7" Round or Square battery backup modules

Battery backup module and Blink fixture sold separately.

Features

- 24 hour recharge time
- 90 minute operation from battery
- Switching time: < 1 second
- Over-charge / discharge protection
- Self-checking function
- Test button

Replacement battery – 26F18650
2600 mAh, 5.2A



Item#	Description	Color
S29656	9" Round Battery Back Up	White
S29657	9" Round Battery Back Up – Empty Casing*	White
S29658	9" Square Battery Back Up	White
S29659	9" Square Battery Back Up – Empty Casing*	White

* Used to maintain consistent appearance with Blinks utilizing the battery back up.

Blink™ 9" Round or Square battery backup modules

Battery backup module and Blink fixture sold separately.

Features

- 24 hour recharge time
- 90 minute operation from battery
- Switching time: < 1 second
- Over-charge / discharge protection
- Self-checking function
- Test button

Replacement battery – 26F18650
2600 mAh, 5.2A



S9656, S9657



S9658, S9659

Item#	Description	Color
S8672	13" Round Battery Back Up	White
S8673	13" Round Battery Back Up	Brushed Nickel
S8674	13" Round Battery Back Up – Empty Casing*	White
S8675	13" Round Battery Back Up – Empty Casing*	Brushed Nickel

* Used to maintain consistent appearance with Blinks utilizing the battery back up.

Blink™ 13" Round battery backup modules

Battery backup module and Blink fixture sold separately.

Features

- 24 hour recharge time
- 90 minute operation from battery
- Switching time: < 1 second
- Over-charge / discharge protection
- Self-checking function
- Test button

Replacement battery – 26F18650
2600 mAh, 5.2A



Item#	Description	Finish	Light Source	Watts	Volts	Length	Width	Height	Ext.	CCT	Lumens	CRI	Cert. Type
S9880	6" Round	White	LED	12.5	120	•	6"	1"	•	3000K	690*	90	Damp
S9881	8" Round	White	LED	16.5	120	•	8"	1"	•	3000K	940*	90	Damp

*Lumens measured at LED source.

** Consult Satco or visit www.satco.com for an up to date dimmer compatibility list.



**



6" and 8" Blink™ LED "Eco" fixtures

Applications

- Kitchens
- Bathrooms
- Hallways
- Family rooms
- Offices

Features

- Lightweight polycarbonate housing
- Dimmable**
- Damp location
- Available in White, 3000K
- 6" and 8" options
- Mounts directly to 3" and 4" junction boxes
- 90 CRI
- ENERGY STAR certified
- 5 Year limited warranty



S9980

Item#	Description	Finish	Light Source	Watts	Volts	Length	Width	Height	Ext.	CCT	Lumens	CRI	Cert. Type
S9368	5" x 18" Rectangular	White	LED	16	120	18"	5"	1"	•	3000K	950*	90	Wet
S9369	7" x 18" Rectangular	White	LED	24	120	18"	7"	1"	•	3000K	1,300*	90	Wet

*Lumens measured at LED source.

** Consult Satco or visit www.satco.com for an up to date dimmer compatibility list.



**



5" x 18" and 7" x 18" Blink™ LED rectangular fixtures

Applications

- Kitchens
- Bathrooms
- Hallways
- Meeting rooms
- Hospitality
- Health care
- Offices
- Retail

Features

- Dimmable**
- Damp location
- ENERGY STAR certified
- 5 Year limited warranty



S9368



S9369

Item#	Description	Finish	Light Source	Watts	Volts	Length	Width	Height	Ext.	CCT	Lumens	CRI	Cert. Type
S9882	7" Round Slim	White	LED	12	120-277	•	7"	5/8"	•	3000K	960*	90	Damp
S9883	7" Round Slim	Brushed Nickel	LED	12	120-277	•	7"	5/8"	•	3000K	960*	90	Damp
S9884	7" Round Slim	Polished Nickel	LED	12	120-277	•	7"	5/8"	•	3000K	960*	90	Damp
S9885	7" Round Slim	Bronze	LED	12	120-277	•	7"	5/8"	•	3000K	960*	90	Damp
S9886	9" Round Slim	White	LED	16	120-277	•	9"	5/8"	•	3000K	1,300*	90	Damp
S9887	9" Round Slim	Brushed Nickel	LED	16	120-277	•	9"	5/8"	•	3000K	1,300*	90	Damp
S9888	9" Round Slim	Polished Nickel	LED	16	120-277	•	9"	5/8"	•	3000K	1,300*	90	Damp
S9889	9" Round Slim	Bronze	LED	16	120-277	•	9"	5/8"	•	3000K	1,300*	90	Damp

*Lumens measured at LED source.

** Consult Satco or visit www.satco.com for an up to date dimmer compatibility list.



7" and 9" Blink™ LED "Slim" fixtures

New ultra-thin 5/8" edge lit
flush mount fixture

Applications

- Kitchens
- Bathrooms
- Hallways
- Family rooms
- Offices

Features

- Dimmable, 120V only**
- Damp location
- Available in White, Brushed Nickel, Polished Nickel and Bronze
- Mounts directly to 3" and 4" junction boxes
- 90 CRI
- ENERGY STAR certified
- 5 Year limited warranty



S9883
Brushed Nickel 7"



S9889
Bronze 9"

Item#	Description	Finish	For Use with	Cord Length
62-1301	7" Blink Slim Pendant Kit	White	S9882 7" Round Slim	12 Foot Cord
62-1302	9" Blink Slim Pendant Kit	White	S9886 9" Round Slim	12 Foot Cord
62-1303	7" Blink Slim Pendant Kit	Bronze	S9885 7" Round Slim	12 Foot Cord
62-1304	9" Blink Slim Pendant Kit	Bronze	S9889 9" Round Slim	12 Foot Cord
62-1305	7" Blink Slim Pendant Kit	Brushed Nickel	S9883 7" Round Slim	12 Foot Cord
62-1306	9" Blink Slim Pendant Kit	Brushed Nickel	S9887 9" Round Slim	12 Foot Cord
62-1307	7" Blink Slim Pendant Kit	Polished Nickel	S9884 7" Round Slim	12 Foot Cord
62-1308	9" Blink Slim Pendant Kit	Polished Nickel	S9888 9" Round Slim	12 Foot Cord

Blink™ accessory Slim 7", 9" pendant kits

Blink LED Slim fixtures
sold separately

Applications / Features

- For use with Blink Slim 7" & 9" round LED fixtures
- White, Bronze, Brushed Nickel or Polished Nickel finishes
- Fixtures not included
- Kit includes pendant, ceiling canopy, 12' cord and all necessary mounting hardware.



7" White

9" Brushed Nickel

9" Polished Nickel

7" Bronze

Item#	Description	Finish	Light Source	Watts	Volts	Length	Width	Height	Ext.	CCT	Lumens	CRI	Cert. Type
62-1161	7" Disk Light	White	LED	10.5	120	•	7 1/6"	1 1/6"	•	3000K	578*	90	Damp
62-1162	7" Disk Light	Brushed Nickel	LED	10.5	120	•	7 1/6"	1 1/6"	•	3000K	578*	90	Damp
62-1163	7" Disk Light	Mahogany Bronze	LED	10.5	120	•	7 1/6"	1 1/6"	•	3000K	578*	90	Damp
62-1164	7" Disk Light	White	LED	10.5	120	•	7 1/6"	1 1/6"	•	4000K	578*	90	Damp
62-1165	10" Disk Light	White	LED	12	120	•	10 13/16"	1 7/16"	•	3000K	700*	90	Damp
62-1166	10" Disk Light	Brushed Nickel	LED	12	120	•	10 13/16"	1 7/16"	•	3000K	700*	90	Damp
62-1167	10" Disk Light	Mahogany Bronze	LED	12	120	•	10 13/16"	1 7/16"	•	3000K	700*	90	Damp
62-1168	10" Disk Light	White	LED	12	120	•	10 13/16"	1 7/16"	•	4000K	700*	90	Damp

*Lumens measured at LED source.

** Consult Satco or visit www.satco.com for an up to date dimmer compatibility list.



7" and 10" LED disk light

Applications

- Kitchen
- Bathroom
- Hallway
- Closets
- Office

Features

- 10.5 Watts = 60 Watt equivalent
- 12 Watts = 75 Watt equivalent
- 90 CRI
- Dimmable**
- Long life–50,000 hours
- Durable white polymer lens
- cETLus damp location
- ENERGY STAR certified
- 5 Year warranty



62-1161



62-1162



62-1163



LED Module – 7"



LED Module – 10"

Item#	Description	Finish	Light Source	Watts	Volts	Length	Width	Height	Ext.	CCT	Lumens	CRI	Cert. Type
62-1261	7" Disk Light	White	LED	16.5	120	•	7 1/16"	1 1/16"	•	3000K	1,000*	90	Wet
62-1262	7" Disk Light	Brushed Nickel	LED	16.5	120	•	7 1/16"	1 1/16"	•	3000K	1,000*	90	Wet
62-1263	7" Disk Light	Mahogany Bronze	LED	16.5	120	•	7 1/16"	1 1/16"	•	3000K	1,000*	90	Wet
62-1264	7" Disk Light	White	LED	16.5	120	•	7 1/16"	1 1/16"	•	4000K	1,050*	90	Wet
62-1265	10" Disk Light	White	LED	21.5	120	•	10 13/16"	1 7/16"	•	3000K	1,200*	90	Damp
62-1266	10" Disk Light	Brushed Nickel	LED	21.5	120	•	10 13/16"	1 7/16"	•	3000K	1,200*	90	Damp
62-1267	10" Disk Light	Mahogany Bronze	LED	21.5	120	•	10 13/16"	1 7/16"	•	3000K	1,200*	90	Damp
62-1268	10" Disk Light	White	LED	21.5	120	•	10 13/16"	1 7/16"	•	4000K	1,260*	90	Damp

*Lumens measured at LED source.

** Consult Satco or visit www.satco.com for an up to date dimmer compatibility list.



7" and 10" High lumen LED disk light

Applications

- Kitchen
- Bathroom
- Hallway
- Closets
- Office

Features

- 16.5 Watts = 75 Watt equivalent
- 21.5 Watts = 100 Watt equivalent
- 90 CRI
- Dimmable**
- Long life—50,000 hours
- Durable white polymer lens
- cETLus damp location
- ENERGY STAR certified
- 5 Year warranty



62-1261



62-1262



62-1267



LED Module – 7"



LED Module – 10"

Exterior Expressions.

Lasting first impressions begin here.





Item#	Description	Finish	Light Source	Watts	Incand. Equiv.	Length	Width	Height	Ext.	CCT	Lumens	CRI	Cert. Type
62-1221	Up / Down Sconce	Anthracite	LED	8.6	60W	•	10 1/2"	4 3/4"	6"	3000K	628*	90	Wet
62-1223	Up / Down Sconce	Anthracite	LED	12	75W	•	12 1/4"	6"	7 1/2"	3000K	950*	90	Wet

*Lumens measured at LED source.

GENOVA LED

Cast Aluminum Indoor/Outdoor Sconces in Anthracite with White Glass Panels



62-1223



62-1221

Item#	Description	Finish	Light Source	Watts	Incand. Equiv.	Length	Width	Height	Ext.	CCT	Lumens	CRI	Cert. Type
62-1241	Sconce	Anthracite	LED	8.6	60W	•	8 ¼"	4 ¾"	5"	3000K	628*	90	Wet

*Lumens measured at LED source.

URBINO LED

Cast Aluminum Indoor/Outdoor Sconces in Anthracite with White Glass Panels



62-1241



STYLE, EFFICIENCY AND SECURITY MOVE OUTDOORS

Outdoor lighting is surely a necessity, but this requirement shouldn't mean settling for boring design. Verona fixtures achieve design goals – but behind the design, high-tech LED modules deliver clean, consistent light where it's needed most, and do it with extreme efficiency.



VERONA LED

Cast Aluminum Indoor/Outdoor Sconces in Anthracite
with White Glass Panels



62-1231

Item#	Description	Finish	Light Source	Watts	Incand. Equiv.	Length	Width	Height	Ext.	CCT	Lumens	CRI	Cert. Type
62-1231	Up/Down Sconce	Anthracite	LED	17.2	2x60W	•	4 1/8"	10 7/8"	7 1/4"	3000K	1,256*	90	Wet
62-1233	Up/Down Sconce	Anthracite	LED	17.2	2x60W	•	4 1/8"	7 1/4"	7 1/4"	3000K	1,256*	90	Wet
62-1235	Sconce	Anthracite	LED	8.6	60W	•	4 3/4"	4 3/4"	5"	3000K	628*	90	Wet
62-1237	Up/Down Sconce	Anthracite	LED	17.2	2x60W	•	8 1/4"	4 3/4"	5"	3000K	1,256*	90	Wet

*Lumens measured at LED source. Combined up/down lumens.



62-1237



62-1235



62-1233

LANSING

Textured Black / Etched Opal Glass



60-6403



60-6401



60-6402

Item#	Description	Finish	No. of Lights	Lamp Type	Base	Max Watts	Length	Width	Height	Ext.	Cert. Type
60-6401	Small Wall Lantern	Textured Black	1	A19	Med.	100W	•	7"	9 7/8"	7 3/4"	Wet
60-6402	Med. Wall Lantern	Textured Black	1	A19	Med.	100W	•	9"	11 3/8"	9 3/4"	Wet
60-6403	Large Wall Lantern	Textured Black	1	A19	Med.	100W	•	11"	13 3/8"	11 3/4"	Wet
60-6405	Post Lantern	Textured Black	1	A19	Med.	100W	•	11"	16 7/8"	•	Wet
60-6406	Hanging Lantern	Textured Black	1	A19	Med.	100W	•	11"	13 7/8"	•	Damp

Additional chain: (3) 25-6407, Pier Mount Base for post lantern: 25-6406.
Hanging Lantern includes 12' of wire.



60-6406



60-6405

HURON

Aged Bronze / Clear Glass



60-6501



60-6502

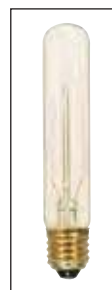

*T9 Vintage lamps included

Item#	Description	Finish	No. of Lights	Lamp Type	Base	Max Watts	Length	Width	Height	Ext.	Cert. Type
60-6501	Large Wall Lantern	Aged Bronze	1	T9*	Med.	60W	•	8 ¼"	18"	9 ¼"	Wet
60-6502	Med. Wall Lantern	Aged Bronze	1	T9*	Med.	60W	•	7"	15 ½"	8"	Wet
60-6503	Post Lantern	Aged Bronze	1	T9*	Med.	60W	•	8 ¼"	20 7/8"	•	Wet
60-6504	Hanging Lantern	Aged Bronze	1	T9*	Med.	60W	•	8 ¼"	18"	•	Damp

*60W T9 S2422 Vintage lamps included.

Additional chain: (3) 25-5004, Pier Mount Base for post lantern: 25-5008. Hanging fixture includes 12' of wire and 4' of chain.



60-6503



60-6504

LAKEVIEW

Aged Bronze / Clear Seed Glass



60-6511



60-6512



*T9 Vintage
lamps included

Item#	Description	Finish	No. of Lights	Lamp Type	Base	Max Watts	Length	Width	Height	Ext.	Cert. Type
60-6511	Large Wall Lantern	Aged Bronze	1	T9*	Med.	60W	•	9"	16 ¼"	10 ¼"	Wet
60-6512	Med. Wall Lantern	Aged Bronze	1	T9*	Med.	60W	•	7"	12 ¼"	8 ¼"	Wet
60-6513	Post Lantern	Aged Bronze	1	T9*	Med.	60W	•	9"	8 ¼"	•	Wet
60-6514	Hanging Lantern	Aged Bronze	1	T9*	Med.	60W	•	9"	16 ¼"	•	Damp

*60W T9 S2422 Vintage lamps included.

Additional chain: (3) 25-5004, Pier Mount Base for post lantern: 25-5008. Hanging fixture includes 12' of wire and 4' of chain.



60-6513



60-6514

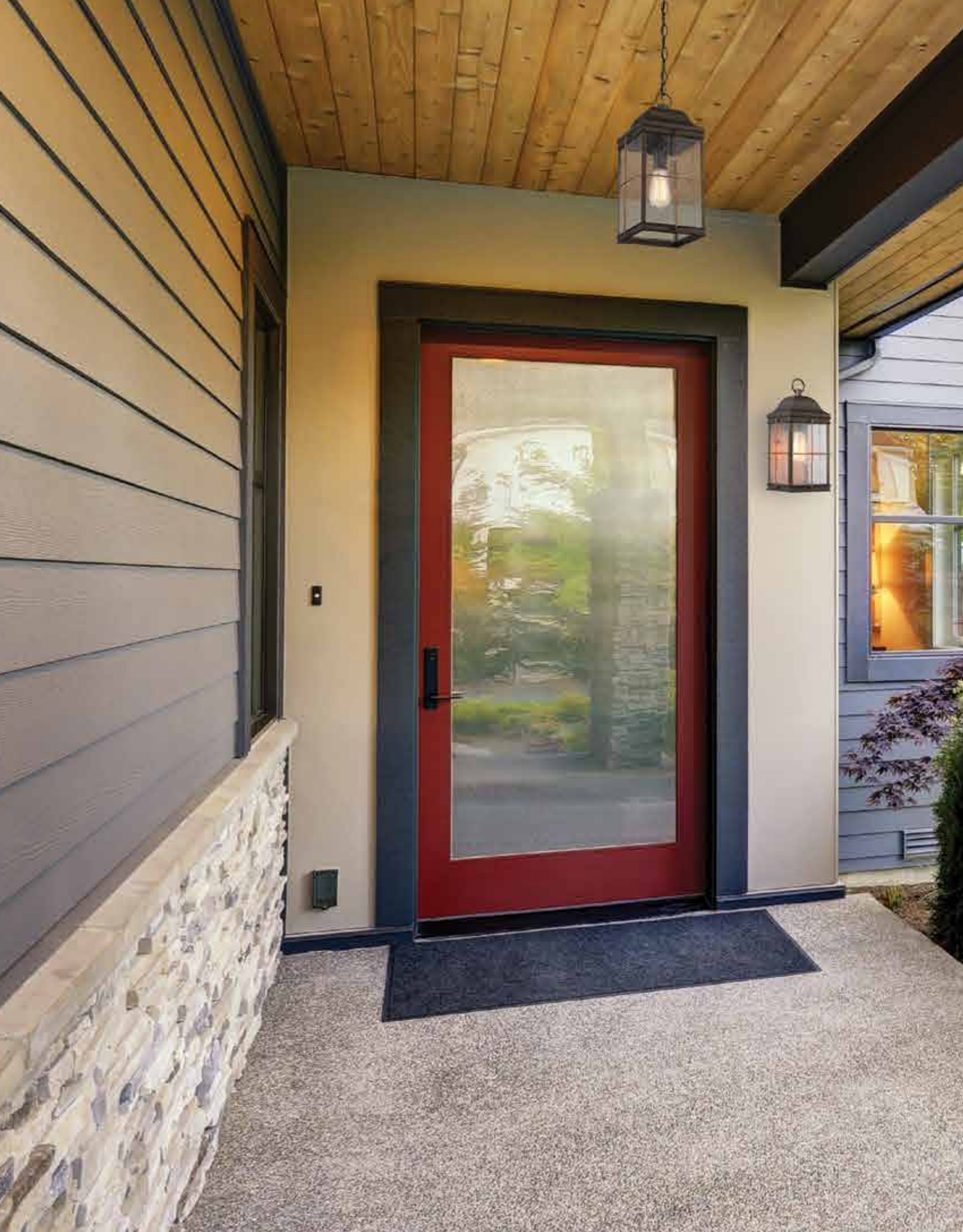



IT'S THE COPPER DETAILS.

Here's the beautiful Howell outdoor family adding just the right amount of elegance to this farmhouse entry. The subtle copper bars on clear seeded glass are the perfect accents of this architectural style.

HOWELL

Bronze with Copper Accents / Clear Seed Glass



60-5833



60-5831



60-5832

Item#	Description	Finish	No. of Lights	Lamp Type	Base	Max Watts	Length	Width	Height	Ext.	Cert. Type
60-5831	Small Wall Lantern	Bronze with Copper	1	A19*	Med.	60W	•	5 ¼"	11 ⅞"	5 ⅜"	Wet
60-5832	Med. Wall Lantern	Bronze with Copper	1	A19*	Med.	60W	•	7"	14 ⅞"	7 ⅞"	Wet
60-5833	Large Wall Lantern	Bronze with Copper	1	A19*	Med.	60W	•	8 ¾"	17 ⅞"	8 ¾"	Wet
60-5834	Flush Lantern	Bronze with Copper	2	A19*	Med.	60W	•	12"	4 ⅞"	•	Wet
60-5835	Post Lantern	Bronze with Copper	1	A19*	Med.	60W	•	8 ¾"	19 ⅜"	•	Wet
60-5836	Hanging Lantern	Bronze with Copper	1	A19*	Med.	60W	•	8 ¾"	17 ⅞"	•	Damp

*60W ST19 S2423 Vintage lamps included.

Additional chain: (3') 25-4225, Pier Mount Base for post: 25-5615.
Hanging fixture includes 12' of wire.



60-5834



60-5836



60-5835



*ST19 Vintage lamps included

TANNER

Claret Bronze / Honey Stained Glass



60-5673



60-5671



60-5672

Item#	Description	Finish	No. of Lights	Lamp Type	Base	Max Watts	Length	Width	Height	Ext.	Cert. Type
60-5671	Small Wall Lantern	Claret Bronze	1	A19	Med.	60W	•	6 ¼"	11 ½"	8 ¾"	Wet
60-5672	Med. Wall Lantern	Claret Bronze	1	A19	Med.	100W	•	8 ¾"	13 ⅝"	10 ⅞"	Wet
60-5673	Large Wall Lantern	Claret Bronze	1	A19	Med.	100W	•	10"	17 ⅝"	13 ⅞"	Wet
60-5674	Hanging Lantern	Claret Bronze	1	A19	Med.	100W	•	8 ¾"	13"	•	Damp
60-5675	Post Lantern	Claret Bronze	1	A19	Med.	100W	•	8 ¾"	14"	•	Wet
60-5676	Flush Lantern	Claret Bronze	2	A19	Med.	60W	•	9 ¼"	5 ⅞"	•	Damp

Additional chain: (3') 25-4644, Pier Mount Base for post: 25-5645.
Hanging fixture includes 12' of wire.



60-5676



60-5674



60-5675

BETHANY LED

Mahogany Bronze / Satin White Glass



62-632



62-633



62-631



†LED Omni[®] "A"
lamps included

Item#	Description	Finish	No. of Lights	Lamp Type	Watts	Incand. Equiv.	Length	Width	Height	Ext.	CCT	Lumens	CRI	Cert. Type
62-631	Small Wall	Mahogany Bronze	(1)	LED/A19/ Med.	10 [†]	60W	•	8 1/2"	14 1/2"	9 3/8"	3000K	810*	90	Wet
62-632	Medium Wall	Mahogany Bronze	(1)	LED/A19/ Med.	10 [†]	60W	•	10"	16 3/4"	10 7/8"	3000K	810*	90	Wet
62-633	Flush	Mahogany Bronze	(1)	LED/A19/ Med.	10 [†]	60W	•	10"	8"	•	3000K	810*	90	Wet
62-634	Post	Mahogany Bronze	(1)	LED/A19/ Med.	10 [†]	60W	•	10"	18 3/8"	•	3000K	810*	90	Wet
62-635	Hanging	Mahogany Bronze	(1)	LED/A19/ Med.	10 [†]	60W	•	10"	15 7/8"	•	3000K	810*	90	Damp

*Lumens measured at LED source.
[†]10 W Omni[®] "A" lamp(s) / Med. base included.

Additional chain: (3') 25-4225.
Hanging fixture includes 12' of wire and 4' of chain.



62-635



62-634

DIEGO LED

Mahogany Bronze / Satin Amber Glass



62-642



62-643



62-641



†LED Omni[®] "A"
lamps included

Item#	Description	Finish	No. of Lights	Lamp Type	Watts	Incand. Equiv.	Length	Width	Height	Ext.	CCT	Lumens	CRI	Cert. Type
62-641	Small Wall	Mahogany Bronze	(1)	LED/A19/ Med.	10 [†]	60W	•	5 1/2"	10 3/8"	6 1/4"	3000K	810*	90	Wet
62-642	Medium Wall	Mahogany Bronze	(1)	LED/A19/ Med.	10 [†]	60W	•	9"	14"	9 3/4"	3000K	810*	90	Wet
62-643	Flush	Mahogany Bronze	(2)	LED/A19/ Med.	20 [†]	2x60W	•	13"	5 1/4"	•	3000K	1,620*	90	Wet
62-644	Post	Mahogany Bronze	(1)	LED/A19/ Med.	10 [†]	60W	•	9"	16 1/8"	•	3000K	810*	90	Wet
62-645	Hanging	Mahogany Bronze	(1)	LED/A19/ Med.	10 [†]	60W	•	9"	14 3/4"	•	3000K	810*	90	Damp

*Lumens measured at LED source.
[†]10 W Omni® "A" lamp(s) / Med. base included.

Additional chain: (3') 25-4225.
Hanging fixture includes 12' of wire and 4' of chain.



62-645



62-644



**INSPIRED DESIGN BY DAY.
IMPRESSIVE EFFICIENCY BY NIGHT.**

Willis LED making a statement in this classic American dwelling; the perfect scale and style.



WILLIS LED

Textured Black / Antique White Glass

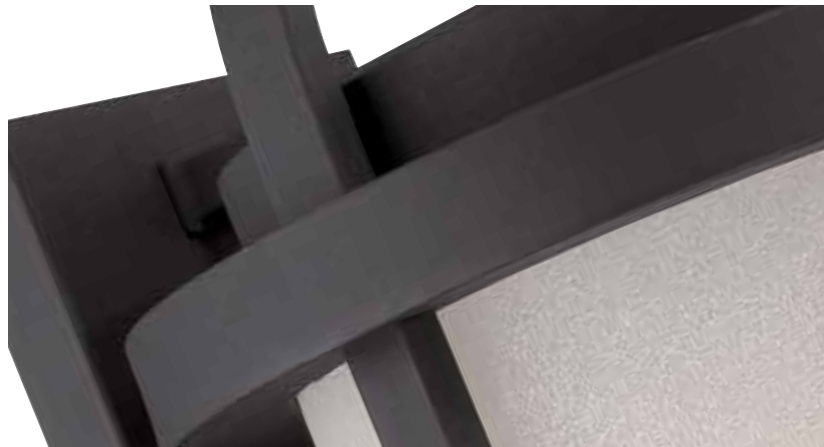

62-652



62-653



62-651



†LED Omni™ "A" lamps included

Item#	Description	Finish	No. of Lights	Lamp Type	Watts	Incand. Equiv.	Length	Width	Height	Ext.	CCT	Lumens	CRI	Cert. Type
62-651	Small Wall	Textured Black	(1)	LED/A19/ Med.	10 [†]	60W	•	7 ¼"	15 ½"	8 ½"	3000K	810*	90	Wet
62-652	Medium Wall	Textured Black	(1)	LED/A19/ Med.	10 [†]	60W	•	9"	17 ½"	9 ¾"	3000K	810*	90	Wet
62-653	Flush	Textured Black	(2)	LED/A19/ Med.	20 [†]	2x60W	•	13 ¾"	5 7/8"	•	3000K	1,620*	90	Wet
62-654	Post	Textured Black	(1)	LED/A19/ Med.	10 [†]	60W	•	9"	19 7/8"	•	3000K	810*	90	Wet
62-655	Hanging	Textured Black	(1)	LED/A19/ Med.	10 [†]	60W	•	9"	19 7/8"	•	3000K	810*	90	Damp

*Lumens measured at LED source.
[†]10 W Omni® "A" lamp(s) / Med. base included.

Additional chain: (3') 25-1071.
Hanging fixture includes 12' of wire and 4' of chain.



62-655



62-654

ESSEX LED

Sterling Black / Etched Glass



62-822



62-823



62-821

Item#	Description	Finish	Light Source	Watts	Incand. Equiv.	Length	Width	Height	Ext.	CCT	Lumens	CRI	Cert. Type
62-821	Small Wall	Sterling Black	LED	12	75W	•	6 1/2"	14"	7 3/4"	3000K	1,020*	80	Wet
62-822	Medium Wall	Sterling Black	LED	12	75W		8 1/4"	16 7/8"	9 5/8"	3000K	1,020*	80	Wet
62-823	Flush	Sterling Black	LED	15	100W		11"	5 1/4"		3000K	1,275*	80	Wet
62-824	Hanging	Sterling Black	LED	12	75W		8 1/4"	18 1/8"		3000K	1,020*	80	Wet
62-825	Post	Sterling Black	LED	12	75W		8 1/4"	15 3/8"		3000K	1,020*	80	Damp

*Lumens measured at LED source.

Additional chain: (3) 25-5826.
Hanging fixture includes 12' of wire and 4' of chain.



62-824



62-825

CANYON

Umber Bronze / Honey Stained Glass



60-5653



60-5651



60-5652

Item#	Description	Finish	No. of Lights	Lamp Type	Base	Max Watts	Length	Width	Height	Ext.	Cert. Type
60-5651	Small Wall Lantern	Umber Bronze	1	A19	Med.	60W	•	7 ¾"	10 ⅛"	8 ½"	Wet
60-5652	Med. Wall Lantern	Umber Bronze	1	A19	Med.	100W	•	9"	11 ½"	9 ⅞"	Wet
60-5653	Large Wall Lantern	Umber Bronze	1	A19	Med.	100W	•	11"	14"	11 ⅞"	Wet
60-5654	Hanging Lantern	Umber Bronze	1	A19	Med.	100W	•	8 ⅜"	13"	•	Damp
60-5655	Post Lantern	Umber Bronze	1	A19	Med.	100W	•	9"	12 ¾"	•	Wet
60-5656	Flush Lantern	Umber Bronze	2	A19	Med.	600W	•	11 ¼"	5 ½"	•	Damp

Additional chain: (3') 25-4654, Pier Mount Base for post: 25-5655.
Hanging fixture includes 12' of wire.



60-5656



60-5654



60-5655

STANTON

Claret Bronze / Clear Seed Glass



60-5643



60-5641



60-5642

Item#	Description	Finish	No. of Lights	Lamp Type	Base	Max Watts	Length	Width	Height	Ext.	Cert. Type
60-5641	Small Wall Lantern	Claret Bronze	1	A19	Med.	60W	•	6 ¼"	11 ⅝"	7 ¾"	Wet
60-5642	Med. Wall Lantern	Claret Bronze	1	A19	Med.	100W	•	8"	14 ½"	9 ⅝"	Wet
60-5643	Large Wall Lantern	Claret Bronze	1	A19	Med.	100W	•	10"	17 ⅝"	11 ⅞"	Wet
60-5644	Hanging Lantern	Claret Bronze	1	A19	Med.	100W	•	10"	16 ⅝"	•	Damp
60-5645	Post Lantern	Claret Bronze	1	A19	Med.	100W	•	10"	17 ¾"	•	Wet
60-5646	Flush Lantern	Claret Bronze	2	A19	Med.	60W	•	11 ¼"	5"	•	Damp

Additional chain: (3') 25-4644, Pier Mount Base for post: 25-5645.
Hanging fixture includes 12' of wire.



60-5646



60-5644



60-5645

WINGATE

Textured Black / Clear Seed Glass



60-5623



60-5621



60-5622

Item#	Description	Finish	No. of Lights	Lamp Type	Base	Max Watts	Length	Width	Height	Ext.	Cert. Type
60-5621	Small Wall Lantern	Textured Black	1	A19	Med.	60W	•	6 7/8"	17 7/8"	9 1/4"	Wet
60-5622	Med. Wall Lantern	Textured Black	1	A19	Med.	100W	•	9 7/8"	25 1/4"	13 1/8"	Wet
60-5623	Large Wall Lantern	Textured Black	1	A19	Med.	100W	•	11 5/8"	30 7/8"	15 1/2"	Wet
60-5624	Hanging Lantern	Textured Black	1	A19	Med.	100W	•	9 7/8"	18 1/2"	•	Damp
60-5625	Post Lantern	Textured Black	1	A19	Med.	100W	•	9 7/8"	23"	•	Wet
60-5626	Flush Lantern	Textured Black	2	A19	Med.	60W	•	11 1/4"	5 1/8"	•	Damp

Additional chain: (3') 25-1071, Pier Mount Base for post: 25-1200.
Hanging fixture includes 12' of wire.



60-5626



60-5624



60-5625

VEGA

Classic Bronze / Clear Seed Glass



60-5613



60-5611



60-5612

Item#	Description	Finish	No. of Lights	Lamp Type	Base	Max Watts	Length	Width	Height	Ext.	Cert. Type
60-5611	Small Wall Lantern	Classic Bronze	1	A19	Med.	60W	•	6 1/2"	9 3/4"	8 1/4"	Wet
60-5612	Med. Wall Lantern	Classic Bronze	1	A19	Med.	100W	•	9"	13 1/2"	11 1/4"	Wet
60-5613	Large Wall Lantern	Classic Bronze	1	A19	Med.	100W	•	11"	16 1/2"	13 1/2"	Wet
60-5614	Hanging Lantern	Classic Bronze	1	A19	Med.	100W	•	9"	12"	•	Damp
60-5615	Post Lantern	Classic Bronze	1	A19	Med.	100W	•	9"	13 1/4"	•	Wet
60-5616	Flush Lantern	Classic Bronze	2	A19	Med.	600W	•	11 1/4"	5 1/8"	•	Damp

Additional chain: (3') 25-5614, Pier Mount Base for post: 25-5615.
Hanging fixture includes 12' of wire.



60-5616



60-5614



60-5615

DREXEL

Stone Black / Frosted Seed Glass



60-5603



60-5601



60-5602

Item#	Description	Finish	No. of Lights	Lamp Type	Base	Max Watts	Length	Width	Height	Ext.	Cert. Type
60-5601	Small Wall Lantern	Stone Black	1	A19	Med.	60W	•	7"	10 ½"	8 ½"	Wet
60-5602	Med. Wall Lantern	Stone Black	1	A19	Med.	100W	•	9"	14"	10 ½"	Wet
60-5603	Large Wall Lantern	Stone Black	1	A19	Med.	100W	•	10"	15 ½"	11 ½"	Wet
60-5604	Hanging Lantern	Stone Black	1	A19	Med.	100W	•	10"	16"	•	Damp
60-5605	Post Lantern	Stone Black	1	A19	Med.	100W	•	10"	18"	•	Wet
60-5606	Flush Lantern	Stone Black	2	A19	Med.	60W	•	11"	5 ½"	•	Damp

Additional chain: (3') 25-5604, Pier Mount Base for post: 25-5605.
Hanging fixture includes 12' of wire.



60-5606



60-5604



60-5605

Item#	Description	Finish	Light Source	Watts	Incand. Equiv.	Length	Width	Height	Ext.	CCT	Lumens	CRI	Cert. Type
65-113	Bulkhead	White	LED	20	100W	•	7"	11 ¼"	5 ½"	3000K	1,440*	90	Wet
65-114	Bulkhead	Black	LED	20	100W	•	7"	11 ¼"	5 ½"	3000K	1,440*	90	Wet

*Lumens measured at LED source.

LED 100-277V BULKHEAD

Cast Aluminum. White or Black with Frosted Glass



65-113



65-114

Item#	Description	Finish	Light Source	Watts	Incand. Equiv.	Length	Width	Height	Ext.	CCT	Lumens	CRI	Cert. Type
62-1141	Small Up / Down	White	LED	10	60W	•	5"	6 ¾"	3 ⅛"	3000K	700*	90	Wet
62-1142	Small Up / Down	Black	LED	10	60W	•	5"	6 ¾"	3 ⅛"	3000K	700*	90	Wet
62-1143	Large Up / Down	White	LED	20	2x60W	•	5"	11 ¾"	3 ⅞"	3000K	1,400*	90	Wet
62-1144	Large Up / Down	Black	LED	20	2x60W	•	5"	11 ¾"	3 ⅞"	3000K	1,400*	90	Wet
62-1145	Small Up / Down	Bronze	LED	10	60W	•	5"	6 ¾"	3 ⅛"	3000K	700*	90	Wet
62-1146	Large Up / Down	Bronze	LED	20	2x60W	•	5"	11 ¾"	3 ⅞"	3000K	1,400*	90	Wet

*Lumens measured at LED source. Combined up/down lumens.

LED 120-277V UP/DOWN

Cast Aluminum. White, Black or Bronze



62-1141



62-1142



62-1145



62-1143



62-1144



62-1146

Item#	Description	Finish	Light Source	Watts	Volts	Depth	Width	Height	Ext.	CCT	Lumens	CRI	Cert. Type
65-403**	Horizontal Step Light	Bronze	LED	5	120	1 5/8"	5"	3"	•	3000K	407*	80	Wet
65-404	Horizontal Step Light	Bronze	LED	5	277	1 5/8"	5"	3"	•	3000K	407*	80	Wet
65-407**	Horizontal Step Light	White	LED	5	120	1 5/8"	5"	3"	•	3000K	407*	80	Wet
65-408	Horizontal Step Light	White	LED	5	277	1 5/8"	5"	3"	•	3000K	407*	80	Wet
65-411**	Horizontal Step Light	Gray	LED	5	120	1 5/8"	5"	3"	•	3000K	407*	80	Wet
65-412	Horizontal Step Light	Gray	LED	5	277	1 5/8"	5"	3"	•	3000K	407*	80	Wet

*Lumens measured at LED source.

†Minimum interior box volume of 13 cubic inches

** Consult Satco or visit www.satco.com for an up to date dimmer compatibility list.



LED horizontal step light

Features

- 5W
- Bronze, White or Gray finish
- Rugged construction
- No transformer required
- Easy installation†
- UV stabilized powder coated finish
- Dimmable (120V only)**
- 120V or 277V versions
- 3000K
- Suitable for wet locations
- cULus listed
- Long life—50,000 hours
- 5 Year warranty

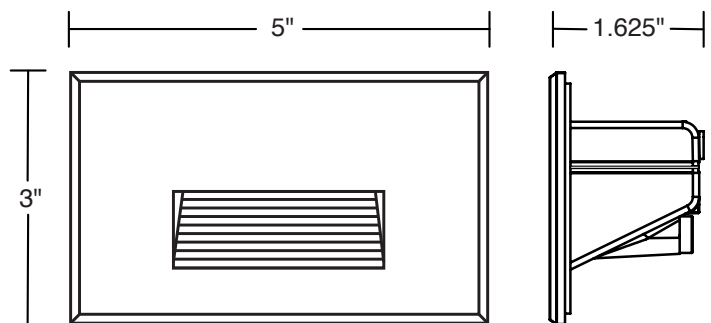

Item#	Description	Finish	Light Source	Watts	Volts	Depth	Width	Height	Ext.	CCT	Lumens	CRI	Cert. Type
65-401**	Vertical Step Light	Bronze	LED	3	120	1 5/8"	3"	5"	•	3000K	200*	80	Wet
65-402	Vertical Step Light	Bronze	LED	3	277	1 5/8"	3"	5"	•	3000K	220*	80	Wet
65-405**	Vertical Step Light	White	LED	3	120	1 5/8"	3"	5"	•	3000K	200*	80	Wet
65-406	Vertical Step Light	White	LED	3	277	1 5/8"	3"	5"	•	3000K	220*	80	Wet
65-409**	Vertical Step Light	Gray	LED	3	120	1 5/8"	3"	5"	•	3000K	200*	80	Wet
65-410	Vertical Step Light	Gray	LED	3	277	1 5/8"	3"	5"	•	3000K	220*	80	Wet

*Lumens measured at LED source.

†Minimum interior box volume of 13 cubic inches

** Consult Satco or visit www.satco.com for an up to date dimmer compatibility list.



LED vertical step light

Features

- 3W
- Bronze, White or Gray finish
- Rugged construction
- No transformer required
- Easy installation†
- UV stabilized powder coated finish
- Dimmable (120V only)**
- 120V or 277V versions
- 3000K
- Suitable for wet locations
- cULus listed
- Long life—50,000 hours
- 5 Year warranty

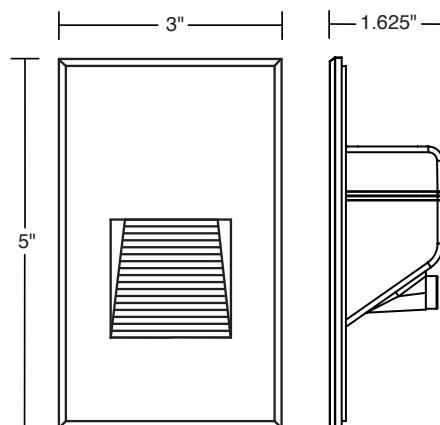

OUTDOOR

Adams Wall Lantern / Arm Up

(1) 100W A19 max. / Medium base

Dimensions: Width 6¹/₈", Height 18¹/₄",
Extension 6⁷/₈", Top to Outlet 13³/₄"

60-4901 White / Frosted Glass



Adams Wall Lantern / Arm Down

(1) 100W A19 max. / Medium base

Dimensions: Width 6¹/₈", Height 13³/₄",
Extension 6⁷/₈", Top to Outlet 9⁵/₈"

60-4904 White / Frosted Glass



Adams Wall Lantern / Arm Up

(1) 100W A19 max. / Medium base

Dimensions: Width 6¹/₈", Height 18¹/₄",
Extension 6⁷/₈", Top to Outlet 13³/₄"

60-4902 Rustic Bronze / Frosted Glass



Adams Wall Lantern / Arm Down

(1) 100W A19 max. / Medium base

Dimensions: Width 6¹/₈", Height 13³/₄",
Extension 6⁷/₈", Top to Outlet 9⁵/₈"

60-4905 Rustic Bronze / Frosted Glass



Adams Wall Lantern / Arm Up

(1) 100W A19 max. / Medium base

Dimensions: Width 6¹/₈", Height 18¹/₄",
Extension 6⁷/₈", Top to Outlet 13³/₄"

60-4903 Textured Black / Frosted Glass



Adams Wall Lantern / Arm Down

(1) 100W A19 max. / Medium base

Dimensions: Width 6¹/₈", Height 13³/₄",
Extension 6⁷/₈", Top to Outlet 9⁵/₈"

60-4906 Textured Black / Frosted Glass



Adams Hanging Lantern

(1) 100W A19 max. / Medium base
Dimensions: Width 6 1/8", Height 15 3/4",
Chain 48", Wire 12'

60-4911 White / Frosted Glass

Accessories:

25-1166 3' Section of White chain



Adams Post Lantern

(1) 100W A19 max. / Medium base
Dimensions: Width 6 1/8", Height 18 1/4"
Fitter 3"

60-4907 White / Frosted Glass

Accessories:

25-1205 White pier mount base



Adams Hanging Lantern

(1) 100W A19 max. / Medium base
Dimensions: Width 6 1/8", Height 15 3/4",
Chain 48", Wire 12'

60-4912 Rustic Bronze / Frosted Glass

Accessories:

25-4998 3' Section of Rustic Bronze chain



Adams Post Lantern

(1) 100W A19 max. / Medium base
Dimensions: Width 6 1/8", Height 18 1/4"
Fitter 3"

60-4908 Rustic Bronze / Frosted Glass

Accessories:

25-4908 Rustic Bronze pier mount base



Adams Hanging Lantern

(1) 100W A19 max. / Medium base
Dimensions: Width 6 1/8", Height 15 3/4",
Chain 48", Wire 12'

60-4913 Textured Black / Frosted Glass

Accessories:

25-1071 3' Section of Textured Black chain



Adams Post Lantern

(1) 100W A19 max. / Medium base
Dimensions: Width 6 1/8", Height 18 1/4"
Fitter 3"

60-4909 Textured Black / Frosted Glass

Accessories:

25-1200 Textured Black pier mount base



OUTDOOR

Banyon Wall Lantern Arm Up

(1) 100W A19 max. / Medium base

Dimensions: Width 6 1/8", Height 17",
Extension 8", Top to Outlet 11 3/4"

60-4924 White / Clear Water Glass



Banyon Wall Lantern Arm Down

(1) 100W A19 max. / Medium base

Dimensions: Width 6 1/8", Height 12 1/4",
Extension 8", Top to Outlet 9 1/4"

60-4921 White / Clear Water Glass



Banyon Wall Lantern Arm Up

(1) 100W A19 max. / Medium base

Dimensions: Width 6 1/8", Height 17",
Extension 8", Top to Outlet 11 3/4"

60-4925 Rustic Bronze / Clear Water Glass



Banyon Wall Lantern Arm Down

(1) 100W A19 max. / Medium base

Dimensions: Width 6 1/8", Height 12 1/4",
Extension 8", Top to Outlet 9 1/4"

60-4922 Rustic Bronze / Clear Water Glass



Banyon Wall Lantern Arm Up

(1) 100W A19 max. / Medium base

Dimensions: Width 6 1/8", Height 17",
Extension 8", Top to Outlet 11 3/4"

60-4926 Textured Black / Clear Water Glass



Banyon Wall Lantern Arm Down

(1) 100W A19 max. / Medium base

Dimensions: Width 6 1/8", Height 12 1/4",
Extension 8", Top to Outlet 9 1/4"

60-4923 Textured Black / Clear Water Glass



Banyon Hanging Lantern

(1) 100W A19 max. / Medium base
Dimensions: Width 6 1/8", Height 10 3/4",
Chain 48", Wire 12'

60-4931 White / Clear Water Glass

Accessories:

25-1166 3' Section of White chain



Banyon Post Lantern

(1) 100W A19 max. / Medium base
Dimensions: Width 6 1/8", Height 17 1/4"
Fitter 3"

60-4927 White / Clear Water Glass

Accessories:

25-1205 White pier mount base



Banyon Hanging Lantern

(1) 100W A19 max. / Medium base
Dimensions: Width 6 1/8", Height 10 3/4",
Chain 48", Wire 12'

60-4932 Rustic Bronze / Clear Water Glass

Accessories:

25-4998 3' Section of Rustic Bronze chain



Banyon Post Lantern

(1) 100W A19 max. / Medium base
Dimensions: Width 6 1/8", Height 17 1/4"
Fitter 3"

60-4928 Rustic Bronze / Clear Water Glass

Accessories:

25-4908 Rustic Bronze pier mount base



Banyon Hanging Lantern

(1) 100W A19 max. / Medium base
Dimensions: Width 6 1/8", Height 10 3/4",
Chain 48", Wire 12'

60-4933 Textured Black / Clear Water Glass

Accessories:

25-1071 3' Section of Textured Black chain



Banyon Post Lantern

(1) 100W A19 max. / Medium base
Dimensions: Width 6 1/8", Height 17 1/4"
Fitter 3"

60-4929 Textured Black / Clear Water Glass

Accessories:

25-1200 Textured Black pier mount base



OUTDOOR

Boxwood Large Wall Lantern / Arm Down

(3) 60W Type B max. / Candelabra base

Dimensions: Width 13", Height 26 1/4",
Extension 12 1/2", Top to Outlet 11"

60-4967 White / Clear Beveled Glass



Boxwood Large Wall Lantern / Arm Down

(3) 60W Type B max. / Candelabra base

Dimensions: Width 13", Height 26 1/4",
Extension 12 1/2", Top to Outlet 11"

60-4968 Rustic Bronze / Clear Beveled Glass



Boxwood Large Wall Lantern / Arm Down

(3) 60W Type B max. / Candelabra base

Dimensions: Width 13", Height 26 1/4",
Extension 12 1/2", Top to Outlet 11"

60-4969 Textured Black / Clear Beveled Glass



Boxwood Mid-Size
Wall Lantern / Arm Up

(1) 100W A19 max. / Med. base

Dimensions: Width 8", Height 22",
Extension 7⁷/₈", Top to Outlet 16"

60-4971 White / Clear Beveled Glass



Boxwood Mid-Size
Wall Lantern / Arm Up

(1) 100W A19 max. / Med. base

Dimensions: Width 8", Height 22",
Extension 7⁷/₈", Top to Outlet 16"

60-4972 Rustic Bronze / Clear Beveled Glass



Boxwood Mid-Size
Wall Lantern / Arm Up

(1) 100W A19 max. / Med. base

Dimensions: Width 8", Height 22",
Extension 7⁷/₈", Top to Outlet 16"

60-4973 Textured Black / Clear Beveled Glass



OUTDOOR

Boxwood Mid-Size Wall Lantern / Arm Down

1) 100W A19 max. / Medium base

Dimensions: Width 9⁷/₈", Height 19",
Extension 9", Top to Outlet 7¹/₄"

60-4964 White / Clear Beveled Glass



Boxwood Small Wall Lantern / Arm Down

(1) 100W A19 max. / Med. base

Dimensions: Width 8", Height 15³/₄",
Extension 7⁷/₈", Top to Outlet 5³/₄"

60-4961 White / Clear Beveled Glass



Boxwood Mid-Size Wall Lantern / Arm Down

1) 100W A19 max. / Medium base

Dimensions: Width 9⁷/₈", Height 19",
Extension 9", Top to Outlet 7¹/₄"

60-4965 Rustic Bronze / Clear Beveled Glass



Boxwood Small Wall Lantern / Arm Down

(1) 100W A19 max. / Med. base

Dimensions: Width 8", Height 15³/₄",
Extension 7⁷/₈", Top to Outlet 5³/₄"

60-4962 Rustic Bronze / Clear Beveled Glass



Boxwood Mid-Size Wall Lantern / Arm Down

1) 100W A19 max. / Medium base

Dimensions: Width 9⁷/₈", Height 19",
Extension 9", Top to Outlet 7¹/₄"

60-4966 Textured Black / Clear Beveled Glass



Boxwood Small Wall Lantern / Arm Down

(1) 100W A19 max. / Med. base

Dimensions: Width 8", Height 15³/₄",
Extension 7⁷/₈", Top to Outlet 5³/₄"

60-4963 Textured Black / Clear Beveled Glass



Boxwood Hanging Lantern

(1) 100W A19 max. / Medium base

Dimensions: Width 8", Height 13³/₄",
Chain 48", Wire 12'

60-4977 White / Clear Beveled Glass

Accessories:

25-1166 3' Section of White chain



Boxwood Post Lantern

(1) 100W A19 max. / Medium base

Dimensions: Width 8", Height 19¹/₄"
Fitter 3"

60-4974 White / Clear Beveled Glass

Accessories:

25-1205 White pier mount base



Boxwood Hanging Lantern

(1) 100W A19 max. / Medium base

Dimensions: Width 8", Height 13³/₄",
Chain 48", Wire 12'

60-4978 Rustic Bronze / Clear Beveled Glass

Accessories:

25-4998 3' Section of Rustic Bronze chain



Boxwood Post Lantern

(1) 100W A19 max. / Medium base

Dimensions: Width 8", Height 19¹/₄"
Fitter 3"

60-4975 Rustic Bronze / Clear Beveled Glass

Accessories:

25-4908 Rustic Bronze pier mount base



Boxwood Hanging Lantern

(1) 100W A19 max. / Medium base

Dimensions: Width 8", Height 13³/₄",
Chain 48", Wire 12'

60-4979 Textured Black / Clear Beveled Glass

Accessories:

25-1071 3' Section of Textured Black chain



Boxwood Post Lantern

(1) 100W A19 max. / Medium base

Dimensions: Width 8", Height 19¹/₄"
Fitter 3"

60-4976 Textured Black / Clear Beveled Glass

Accessories:

25-1200 Textured Black pier mount base



OUTDOOR

Cove Neck Large Wall Lantern / Arm Down

(1) 100W A19 max. / Medium base

Dimensions: Width 9", Height 14",
Extension 11 1/2", Top to Outlet 6 1/4"

60-4957 White / Clear Seeded Glass



Cove Neck Large Wall Lantern / Arm Down

(1) 100W A19 max. / Medium base

Dimensions: Width 9", Height 14",
Extension 11 1/2", Top to Outlet 6 1/4"

60-4958 Rustic Bronze / Clear Seeded Glass



Cove Neck Large Wall Lantern / Arm Down

(1) 100W A19 max. / Medium base

Dimensions: Width 9", Height 14",
Extension 11 1/2", Top to Outlet 6 1/4"

60-4959 Textured Black / Clear Seeded Glass



Cove Neck Small
Wall Lantern / Arm Down

(1) 100W A19 max. / Medium base
Dimensions: Width 7", Height 11 3/4",
Extension 9 1/2", Top to Outlet 5 1/4"
60-4951 White / Clear Seeded Glass



Cove Neck Hanging Lantern

(1) 100W A19 max. / Medium base
Dimensions: Width 7", Height 12"
60-4954 White / Clear Seeded Glass
Accessories:
25-1166 3' Section of White chain



Cove Neck Small
Wall Lantern / Arm Down

(1) 100W A19 max. / Medium base
Dimensions: Width 7", Height 11 3/4",
Extension 9 1/2", Top to Outlet 5 1/4"
60-4952 Rustic Bronze / Clear Seeded Glass



Cove Neck Hanging Lantern

(1) 100W A19 max. / Medium base
Dimensions: Width 7", Height 12"
60-4955 Rustic Bronze / Clear Seeded Glass
Accessories:
25-4998 3' Section of Rustic Bronze chain



Cove Neck Small
Wall Lantern / Arm Down

(1) 100W A19 max. / Medium base
Dimensions: Width 7", Height 11 3/4",
Extension 9 1/2", Top to Outlet 5 1/4"
60-4953 Textured Black / Clear Seeded Glass



Cove Neck Hanging Lantern

(1) 100W A19 max. / Medium base
Dimensions: Width 7", Height 12"
60-4956 Textured Black / Clear Seeded Glass
Accessories:
25-1071 3' Section of Textured Black chain



OUTDOOR

Central Park Large Wall Lantern / Arm Up

(3) 60W Type B max. / Candelabra base

Dimensions: Width 7³/₈", Height 22³/₄",
Extension 11 1/2", Top to Outlet 15"

60-888 White / Clear Beveled Panels



Central Park Large Wall Lantern / Arm Up

(3) 60W Type B max. / Candelabra base

Dimensions: Width 7³/₈", Height 22³/₄",
Extension 11 1/2", Top to Outlet 15"

60-889 Old Bronze / Clear Beveled Panels



Central Park Large Wall Lantern / Arm Up

(3) 60W Type B max. / Candelabra base

Dimensions: Width 7³/₈", Height 22³/₄",
Extension 11 1/2", Top to Outlet 15"

60-890 Textured Black / Clear Beveled Panels



Central Park
Large Wall Lantern / Arm Down

(3) 60W Type B max. / Candelabra base

Dimensions: Width 7³/₈", Height 22³/₄",
Extension 11¹/₂", Top to Outlet 9"

60-891 White / Clear Beveled Panels



Central Park
Large Wall Lantern / Arm Down

(3) 60W Type B max. / Candelabra base

Dimensions: Width 7³/₈", Height 22³/₄",
Extension 11¹/₂", Top to Outlet 9"

60-892 Old Bronze / Clear Beveled Panels



Central Park
Large Wall Lantern / Arm Down

(3) 60W Type B max. / Candelabra base

Dimensions: Width 7³/₈", Height 22³/₄",
Extension 11¹/₂", Top to Outlet 9"

60-893 Textured Black / Clear Beveled Panels



OUTDOOR

Central Park Small Wall Lantern / Arm Up

(1) 100W A19 max. / Med. base

Dimensions: Width 6", Height 20",
Extension 9³/₄", Top to Outlet 13"

60-885 White / Clear Beveled Panels



Central Park Small Wall Lantern / Arm Up

(1) 100W A19 max. / Med. base

Dimensions: Width 6", Height 20",
Extension 9³/₄", Top to Outlet 13"

60-886 Old Bronze / Clear Beveled Panels



Central Park Small Wall Lantern / Arm Up

(1) 100W A19 max. / Med. base

Dimensions: Width 6", Height 20",
Extension 9³/₄", Top to Outlet 13"

60-887 Textured Black / Clear Beveled Panels



Central Park Hanging Lantern

(3) 60W Type B max. / Candelabra base

Dimensions: Width 7³/₈",
Height 20", Chain 48", Wire 12'

60-894 White / Clear Beveled Panels

Accessories:

25-1166 3' Section of White chain



Central Park Post Lantern

(3) 60W Type B max. / Candelabra base

Dimensions: Width 7³/₈", Height 21"
Fitter 3"

60-897 White / Clear Beveled Panels

Accessories:

25-1205 White pier mount base



Central Park Hanging Lantern

(3) 60W Type B max. / Candelabra base

Dimensions: Width 7³/₈",
Height 20", Chain 48", Wire 12'

60-895 Old Bronze / Clear Beveled Panels

Accessories:

25-1067 3' Section of Old Bronze chain



Central Park Post Lantern

(3) 60W Type B max. / Candelabra base

Dimensions: Width 7³/₈", Height 21"
Fitter 3"

60-898 Old Bronze / Clear Beveled Panels

Accessories:

25-1203 Old Bronze pier mount base



Central Park Hanging Lantern

(3) 60W Type B max. / Candelabra base

Dimensions: Width 7³/₈",
Height 20", Chain 48", Wire 12'

60-896 Textured Black / Clear Beveled Panels

Accessories:

25-1071 3' Section of Textured Black chain



Central Park Post Lantern

(3) 60W Type B max. / Candelabra base

Dimensions: Width 7³/₈", Height 21"
Fitter 3"

60-899 Textured Black / Clear Beveled Panels

Accessories:

25-1200 Textured Black pier mount base



OUTDOOR

Cornerstone Wall Lantern / Arm Up

Long & Short Tail Provided

(1) 60W A19 max. / Medium base

Dimensions: Width 7",
Height w/short tail 12", w/long tail 18",
Extension 9 1/4", Top to Outlet 11"

60-985 White / Clear Seeded Glass



Cornerstone Wall Lantern / Arm Down

(1) 60W A19 max. / Medium base

Dimensions: Width 7", Height 13",
Extension 9 1/4", Top to Outlet 4"

60-988 White / Clear Seeded Glass



Cornerstone Wall Lantern / Arm Up

Long & Short Tail Provided

(1) 60W A19 max. / Medium base

Dimensions: Width 7",
Height w/short tail 12", w/long tail 18",
Extension 9 1/4", Top to Outlet 11"

60-986 Old Bronze / Clear Seeded Glass



Cornerstone Wall Lantern / Arm Down

(1) 60W A19 max. / Medium base

Dimensions: Width 7", Height 13",
Extension 9 1/4", Top to Outlet 4"

60-989 Old Bronze / Clear Seeded Glass



Cornerstone Wall Lantern / Arm Up

Long & Short Tail Provided

(1) 60W A19 max. / Medium base

Dimensions: Width 7",
Height w/short tail 12", w/long tail 18",
Extension 9 1/4", Top to Outlet 11"

60-987 Textured Black / Clear Seeded Glass



Cornerstone Wall Lantern / Arm Down

(1) 60W A19 max. / Medium base

Dimensions: Width 7", Height 13",
Extension 9 1/4", Top to Outlet 4"

60-990 Textured Black / Clear Seeded Glass



Cornerstone Hanging Lantern

(1) 60W A19 max. / Medium base

Dimensions: Width 7",
Height 12⁵/₈", Chain 48", Wire 12'

60-991 White / Clear Seeded Glass

Accessories:

25-1166 3' Section of White chain



Cornerstone Post Lantern

(1) 60W A19 max. / Medium base

Dimensions: Width 7", Height 14¹/₄"
Fitter 3"

60-994 White / Clear Seeded Glass

Accessories:

25-1205 White pier mount base



Cornerstone Hanging Lantern

(1) 60W A19 max. / Medium base

Dimensions: Width 7",
Height 12⁵/₈", Chain 48", Wire 12'

60-992 Old Bronze / Clear Seeded Glass

Accessories:

25-1067 3' Section of Old Bronze chain



Cornerstone Post Lantern

(1) 60W A19 max. / Medium base

Dimensions: Width 7", Height 14¹/₄"
Fitter 3"

60-995 Old Bronze / Clear Seeded Glass

Accessories:

25-1203 Old Bronze pier mount base



Cornerstone Hanging Lantern

(1) 60W A19 max. / Medium base

Dimensions: Width 7",
Height 12⁵/₈", Chain 48", Wire 12'

60-993 Textured Black / Clear Seeded Glass

Accessories:

25-1071 3' Section of Textured Black chain



Cornerstone Post Lantern

(1) 60W A19 max. / Medium base

Dimensions: Width 7", Height 14¹/₄"
Fitter 3"

60-996 Textured Black / Clear Seeded Glass

Accessories:

25-1200 Textured Black pier mount base



OUTDOOR

Briton Wall Lantern / Arm Up

Long & Short Tail Provided

(1) 60W A19 max. / Medium base

Dimensions: Width 6",
Height w/short tail 15", w/long tail 18",
Extension 6 1/8", Top to Outlet 12"

60-540 White / Clear Glass



Briton Wall Lantern / Arm Up

Long & Short Tail Provided

(1) 60W A19 max. / Medium base

Dimensions: Width 6",
Height w/short tail 15", w/long tail 18",
Extension 6 1/8", Top to Outlet 12"

60-541 Old Bronze / Clear Glass



Briton Wall Lantern / Arm Up

Long & Short Tail Provided

(1) 60W A19 max. / Medium base

Dimensions: Width 6",
Height w/short tail 15", w/long tail 18",
Extension 6 1/8", Top to Outlet 12"

60-542 Textured Black / Clear Glass



Briton Hanging Lantern

(1) 60W A19 max. / Medium base
Dimensions: Width 6", Height 9½", Chain 48",
Wire 12'

60-487 White / Clear Glass

Accessories:

25-1166 3' Section of White chain



Briton Post Lantern

(1) 60W A19 max. / Medium base
Dimensions: Width 6", Height 14"
Fitter 3"

60-546 White / Clear Glass

Accessories:

25-1205 White pier mount base



Briton Hanging Lantern

(1) 60W A19 max. / Medium base
Dimensions: Width 6", Height 9½", Chain 48",
Wire 12'

60-488 Old Bronze / Clear Glass

Accessories:

25-1067 3' Section of Old Bronze chain



Briton Post Lantern

(1) 60W A19 max. / Medium base
Dimensions: Width 6", Height 14"
Fitter 3"

60-547 Old Bronze / Clear Glass

Accessories:

25-1203 Old Bronze pier mount base



Briton Hanging Lantern

(1) 60W A19 max. / Medium base
Dimensions: Width 6", Height 9½", Chain 48",
Wire 12'

60-489 Textured Black / Clear Glass

Accessories:

25-1071 3' Section of Textured Black chain



Briton Post Lantern

(1) 60W A19 max. / Medium base
Dimensions: Width 6", Height 14"
Fitter 3"

60-548 Textured Black / Clear Glass

Accessories:

25-1200 Textured Black pier mount base



OUTDOOR

Onion Small Wall Lantern

(1) 60W A19 max. / Medium base

Dimensions: Width 6", Height 10⁵/₈",
Extension 8", Top to Outlet 4¹/₂"

60-630 White / Clear Seed Glass



Piper Small Wall Lantern

(1) 60W A19 max. / Medium base

Dimensions: Width 5", Height 10⁵/₈",
Extension 7", Top to Outlet 6"

60-633 White / Clear Seed Glass



Onion Small Wall Lantern

(1) 60W A19 max. / Medium base

Dimensions: Width 6", Height 10⁵/₈",
Extension 8", Top to Outlet 4¹/₂"

60-631 Old Bronze / Clear Seed Glass



Piper Small Wall Lantern

(1) 60W A19 max. / Medium base

Dimensions: Width 5", Height 10⁵/₈",
Extension 7", Top to Outlet 6"

60-634 Old Bronze / Clear Seed Glass



Onion Small Wall Lantern

(1) 60W A19 max. / Medium base

Dimensions: Width 6", Height 10⁵/₈",
Extension 8", Top to Outlet 4¹/₂"

60-632 Textured Black / Clear Seed Glass



Piper Small Wall Lantern

(1) 60W A19 max. / Medium base

Dimensions: Width 5", Height 10⁵/₈",
Extension 7", Top to Outlet 6"

60-635 Textured Black / Clear Seed Glass



Cube Small Wall Lantern

(1) 60W A19 max. / Medium base

Dimensions: Width 4³/₈", Height 8⁵/₈",
Extension 6¹/₈", Top to Outlet 3"

60-636 White / Clear Beveled Glass



Hood Small Wall Lantern

(1) 60W A19 max. / Medium base

Dimensions: Width 6", Height 8⁷/₈",
Extension 6⁷/₈", Top to Outlet 3¹/₂"

60-639 White / Satin Frosted Glass



Cube Small Wall Lantern

(1) 60W A19 max. / Medium base

Dimensions: Width 4³/₈", Height 8⁵/₈",
Extension 6¹/₈", Top to Outlet 3"

60-637 Old Bronze / Clear Beveled Glass



Hood Small Wall Lantern

(1) 60W A19 max. / Medium base

Dimensions: Width 6", Height 8⁷/₈",
Extension 6⁷/₈", Top to Outlet 3¹/₂"

60-640 Old Bronze / Satin Frosted Glass



Cube Small Wall Lantern

(1) 60W A19 max. / Medium base

Dimensions: Width 4³/₈", Height 8⁵/₈",
Extension 6¹/₈", Top to Outlet 3"

60-638 Textured Black / Clear Beveled Glass



Hood Small Wall Lantern

(1) 60W A19 max. / Medium base

Dimensions: Width 6", Height 8⁷/₈",
Extension 6⁷/₈", Top to Outlet 3¹/₂"

60-641 Textured Black / Satin Frosted Glass



OUTDOOR

Die Cast Cage Lantern

Linen Acrylic Lens

(1) 60W A19 max. / Medium base

Dimensions: Width 7³/₄",
Height 9³/₄", Extension 4¹/₄"

60-537 White



Die Cast Ceiling "Spider" Cage

Glass Lens

(1) 60W A19 max. / Medium base

Dimensions: Width 11³/₈", Height 5"

60-534 White



Die Cast Cage Lantern

Linen Acrylic Lens

(1) 60W A19 max. / Medium base

Dimensions: Width 7³/₄",
Height 9³/₄", Extension 4¹/₄"

60-538 Old Bronze



Die Cast Ceiling "Spider" Cage

Glass Lens

(1) 60W A19 max. / Medium base

Dimensions: Width 11³/₈", Height 5"

60-535 Old Bronze



Die Cast Cage Lantern

Linen Acrylic Lens

(1) 60W A19 max. / Medium base

Dimensions: Width 7³/₄",
Height 9³/₄", Extension 4¹/₄"

60-539 Textured Black



Die Cast Ceiling "Spider" Cage

Glass Lens

(1) 60W A19 max. / Medium base

Dimensions: Width 11³/₈", Height 5"

60-536 Textured Black



Die Cast Round Hood Bulkhead

(1) 60W A19 max. / Medium base
Dimensions: Diameter 10",
Extension 5"
60-520 Semi Gloss White



Die Cast Round Hood Bulkhead

(1) 60W A19 max. / Medium base
Dimensions: Diameter 10",
Extension 5"
60-521 Architectural Bronze



Die Cast Oval Cage Bulkhead

(1) 60W A19 max. / Medium base
Dimensions: Width 6 1/8",
Height 10", Extension 5 1/2"
60-524 Semi Gloss White



Die Cast Oval Cage Bulkhead

(1) 60W A19 max. / Medium base
Dimensions: Width 6 1/8",
Height 10", Extension 5 1/2"
60-525 Architectural Bronze



Die Cast Oval Hood Bulkhead

(1) 60W A19 max. / Medium base
Dimensions: Width 10",
Height 6 1/8", Extension 5 1/2"
60-522 Semi Gloss White



Die Cast Oval Hood Bulkhead

(1) 60W A19 max. / Medium base
Dimensions: Width 10",
Height 6 1/8", Extension 5 1/2"
60-523 Architectural Bronze



OUTDOOR

Die Cast Rectangle Bulkhead

(1) 60W A19 max. / Medium base
Dimensions: Width 6½",
Height 10", Extension 4⁷/₈"
60-530 Semi Gloss White



Die Cast Rectangle Bulkhead

(1) 60W A19 max. / Medium base
Dimensions: Width 6½",
Height 10", Extension 4⁷/₈"
60-531 Architectural Bronze



Die Cast Large Oval Bulkhead

(1) 60W A19 max. / Medium base
Dimensions: Width 9",
Height 11", Extension 4³/₈"
60-526 Semi Gloss White



Die Cast Large Oval Bulkhead

(1) 60W A19 max. / Medium base
Dimensions: Width 9",
Height 11", Extension 4³/₈"
60-527 Architectural Bronze



Die Cast Oblong Round Bulkhead

(1) 60W A19 max. / Medium base
Dimensions: Width 9¹/₈",
Height 10½", Extension 4½"
60-516 Semi Gloss White



Die Cast Oblong Round Bulkhead

(1) 60W A19 max. / Medium base
Dimensions: Width 9¹/₈",
Height 10½", Extension 4½"
60-517 Architectural Bronze



Die Cast Rectangle Cage

1) 60W A19 max. / Medium base
Dimensions: Width 6 1/2",
Height 10", Extension 4 7/8"
60-532 Semi Gloss White



Die Cast Rectangle Cage

1) 60W A19 max. / Medium base
Dimensions: Width 6 1/2",
Height 10", Extension 4 7/8"
60-533 Architectural Bronze



Die Cast Large Oval Cage

(1) 60W A19 max. / Medium base
Dimensions: Width 8 1/2",
Height 12 1/2", Extension 5"
60-528 Semi Gloss White



Die Cast Large Oval Cage

(1) 60W A19 max. / Medium base
Dimensions: Width 8 1/2",
Height 12 1/2", Extension 5"
60-529 Architectural Bronze



Die Cast Round Cage

(1) 60W A19 max. / Medium base
Dimensions: Diameter 10", Extension 5"
60-518 Semi Gloss White



Die Cast Round Cage

(1) 60W A19 max. / Medium base
Dimensions: Diameter 10", Extension 5"
60-519 Architectural Bronze



OUTDOOR



Round Cage

Polysynthetic Body and Lens

(1) 60W A19 max. / Medium base

Dimensions: Diameter 10",
Extension 4"

77-861 White



Oval Cage

Polysynthetic Body and Lens

(1) 60W A19 max. / Medium base

Dimensions: Width 10",
Height 5", Extension 4"

77-858 White



Round Cage

Polysynthetic Body and Lens

(1) 60W A19 max. / Medium base

Dimensions: Diameter 10",
Extension 4"

77-859 Black



Oval Cage

Polysynthetic Body and Lens

(1) 60W A19 max. / Medium base

Dimensions: Width 10",
Height 5", Extension 4"

77-857 Black

OUTDOOR

Large Die-Cast Industrial Style Ceiling Mount

(1) 200W A19 max. / Med. base
Dimensions: Height 11", Width 5 1/2"
76-618 White / Frosted Glass



Small Die-Cast Industrial Style Ceiling Mount

(1) 100W A19 max. / Med. base
Dimensions: Height 9 3/8", Width 4 1/4"
76-616 White / Frosted Glass



Large Die-Cast Industrial Style Ceiling Mount

(1) 200W A19 max. / Med. base
Dimensions: Height 11", Width 5 1/2"
76-626 Metallic Silver / Frosted Glass



Small Die-Cast Industrial Style Ceiling Mount

(1) 100W A19 max. / Med. base
Dimensions: Height 9 3/8", Width 4 1/4"
76-624 Metallic Silver / Frosted Glass



Large Die-Cast Industrial Style Ceiling Mount

(1) 200W A19 max. / Med. base
Dimensions: Height 11", Width 5 1/2"
76-627 Old Bronze / Frosted Glass



Small Die-Cast Industrial Style Ceiling Mount

(1) 100W A19 max. / Med. base
Dimensions: Height 9 3/8", Width 4 1/4"
76-625 Old Bronze / Frosted Glass



Large Die-Cast
Industrial Style
Wall Mount

(1) 300W A19 max. / Med. base

Dimensions: Height 11",
Width 5 1/2", Extension 6 3/8"

76-617 White / Frosted Glass

Accessories:

76-650 White Die-cast junction box



Small Die-Cast
Industrial Style
Wall Mount

(1) 150W A19 max. / Med. base

Dimensions: Height 9 3/8",
Width 4 1/4", Extension 5 3/8"

76-615 White / Frosted Glass

Accessories:

76-650 White Die-cast junction box



Large Die-Cast
Industrial Style
Wall Mount

(1) 300W A19 max. / Med. base

Dimensions: Height 11",
Width 5 1/2", Extension 6 3/8"

76-622 Metallic Silver / Frosted Glass

Accessories:

76-651 Metallic Silver Die-cast junction box



Small Die-Cast
Industrial Style
Wall Mount

(1) 150W A19 max. / Med. base

Dimensions: Height 9 3/8",
Width 4 1/4", Extension 5 3/8"

76-620 Metallic Silver / Frosted Glass

Accessories:

76-651 Metallic Silver Die-cast junction box



Large Die-Cast
Industrial Style
Wall Mount

(1) 300W A19 max. / Med. base

Dimensions: Height 11",
Width 5 1/2", Extension 6 3/8"

76-623 Old Bronze / Frosted Glass

Accessories:

76-652 Old Bronze Die-cast junction box



Small Die-Cast
Industrial Style
Wall Mount

(1) 150W A19 max. / Med. base

Dimensions: Height 9 3/8",
Width 4 1/4", Extension 5 3/8"

76-621 Old Bronze / Frosted Glass

Accessories:

76-652 Old Bronze Die-cast junction box



OUTDOOR

Carport Flush Mounts Metal Frame

(2) 60W A19 max. / Medium base

Dimensions: Width 9¹/₄", Height 5"

60-470 White / Textured Frosted Glass

60-471 Polished Brass / Textured Frosted Glass

60-472 Old Bronze / Textured Frosted Glass

60-473 Black / Textured Frosted Glass



Carport Flush Mounts Small Poly Frame

(1) 60W A19 max. / Medium base

Dimensions: Width 8¹/₄", Height 4³/₄"

77-835 White / Frosted Glass

77-863 Black / Frosted Glass

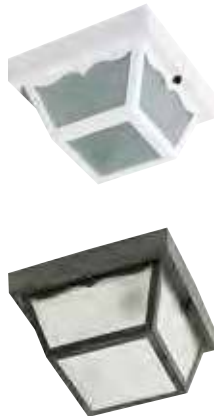

Carport Flush Mounts Large Poly Frame

(2) 60W A19 max. / Medium base

Dimensions: Width 10¹/₄", Height 5¹/₂"

77-879 White / Frosted Glass

77-891 Black / Frosted Glass



Utility Wall Mount–Globe

(1) 100W A19 max. / Medium base

Dimensions: Width 6",
Height 7¹/₄", Extension 7"

77-531 White / White Glass

77-139 Satin Aluminum / White Glass

77-141 Bronzotic / White Glass

77-140 Black / White Glass



Utility Ceiling Mount–Globe

(1) 60W A19 max. / Medium base

Dimensions: Width 6", Height 7 1/4"

77-532 White / White Glass

77-152 Satin Aluminum / White Glass

77-153 Bronzotic / White Glass

77-157 Black / White Glass



Utility Ceiling Mount–Cylinder

(1) 60W A19 max. / Medium base

Dimensions: Width 4 1/4", Height 8"

77-533 White / White Glass

77-155 Satin Aluminum / White Glass

77-156 Bronzotic / White Glass

77-154 Black / White Glass



Utility Wall Mount–Cylinder

(1) 100W A19 max. / Medium base

Dimensions: Width 4 3/4", Height 8", Extension 6"

77-530 White / White Glass

77-136 Satin Aluminum / White Glass

77-138 Bronzotic / White Glass

77-137 Black / White Glass



OUTDOOR

Porch Wall Clear Mason Jar

(1) 60W A19 max. / Medium base

Dimensions: Width 4", Height 8 1/2", Extension 5 1/2"

77-119 Black / Clear Ribbed Glass

77-996 Polished Brass / Clear Ribbed Glass

77-995 Antique Brass / Clear Ribbed Glass



Porch Wall Frosted Mason Jar

(1) 60W A19 max. / Medium base

Dimensions: Width 4", Height 8 1/2", Extension 5 1/2"

76-701 Brushed Nickel / Frosted Ribbed Glass

76-700 Old Bronze / Frosted Ribbed Glass

76-702 Gloss White / Frosted Ribbed Glass



Porch Wall White Glass Globe

(1) 60W A19 max. / Medium base

Dimensions: Width 5 1/2", Height 8 1/2", Extension 6"

76-704 Gloss White / White Glass

76-705 Brushed Nickel / White Glass

77-992 Black / White Glass

76-703 Old Bronze / White Glass



Poly Coach Wall Lantern

(1) 60W A19 max. / Medium base

Dimensions: Width 7³/₄", Height 17", Extension 8"
Top to Outlet 12"

77-897 White / Acrylic Panels

77-896 Black / Acrylic Panels



Poly Coach Post Lantern

(1) 60W A19 max. / Medium base

Dimensions: Width 7³/₄", Height 12¹/₂",

77-899 White / Acrylic Panels

77-898 Black / Acrylic Panels



Poly Mansard Wall Lantern

(1) 60W A19 max. / Medium base

Dimensions: Width 8", Height 17¹/₂", Extension 8",
Top to Outlet 12"

77-853 White / Textured Acrylic Panels

77-852 Black / Textured Acrylic Panels



OUTDOOR

Cast Aluminum One Light PAR38 Floodlights

(1) 150W PAR38 max. / Medium base
Dimensions: Width 4 1/2", Extension 8"

- 77-487 White
- 77-702 Gray
- 77-494 Bronze
- 77-700 Black



Cast Aluminum Two Light PAR38 Floodlights

(2) 150W PAR38 max. / Medium base
Dimensions: Width 15", Extension 8"

- 77-488 White
- 77-703 Gray
- 77-495 Bronze
- 77-701 Black



Add On Motion Sensor

Fits 1/2" Threaded Knockouts

- 76-500 White
- 76-501 Bronze



2 Light "Quick Mount"
Adjustable PAR
Holders

(2) 150W PAR38 max.

Dimensions: Width 8³/₄",
Extension 3¹/₄"

76-684 White

76-685 Bronze



1 Light "Quick Mount"
Adjustable PAR
Holders

(1) 150W PAR38 max.

Dimensions: Width 5",
Extension 3¹/₄"

76-682 White

76-683 Bronze



2 Light PAR
Floodlight
Holders

(2) 150W PAR38 max.

Dimensions: Width 10",
Extension 5"

76-522 White

76-523 Bronze



1 Light PAR
Floodlight
Holders

(1) 150W PAR38 max.

Dimensions: Width 4¹/₂",
Extension 5"

76-520 White

76-521 Bronze



2 Light PAR
Floodlight
Holders

with Motion Sensor

(2) 150W PAR38 max.

Dimensions: Width 10",
Extension 9¹/₂"

76-502 White

76-503 Bronze



2 Light PAR38
Floodlights
with Motion Sensor

(2) 150W PAR38 max.

Dimensions: Width 14",
Extension 9¹/₂"

76-530 White

76-531 Bronze



OUTDOOR

PAR38 Landscape Floodlight

(1) 150W PAR38 max.
Dimensions: Diameter 5 1/2",
Length 12 1/2"

76-648 Dark Bronze
76-658 Antique Verdi



PAR30 Landscape Floodlight

(1) 75W PAR30 (Longneck) max.
Dimensions: Diameter 4 1/4",
Length 11 1/2"

76-647 Dark Bronze
76-657 Antique Verdi



PAR20 Landscape Floodlight

(1) 50W PAR20 max.
Dimensions: Diameter 2 3/4",
Length 6 1/4"

76-646 Dark Bronze
76-656 Antique Verdi



PAR16 Landscape Floodlight

(1) 50W PAR16 max.
Dimensions: Diameter 2 1/2",
Length 5 1/2"

76-645 Dark Bronze
76-655 Antique Verdi



9W LED Landscape Floodlight (PAR20 size)

900 Lumens, 3000K, 80CRI
Dimensions: Diameter 2 5/8",
Length 6 1/4"

62-1203 Dark Gray
62-1204 Light Gray
62-1205 Dark Bronze



6W LED Landscape Floodlight (PAR16 size)

640 Lumens, 3000K, 80CRI
Dimensions: Diameter 2 5/8",
Length 5 1/2"

62-1201 Dark Gray
62-1202 Light Gray
62-1200 Dark Bronze



Three Louver
Small Hood

(1) 100W A19 max. / Medium base

Dimensions: Height 8⁵/₈",
Diameter 6¹/₈"

76-633 Old Bronze

77-324 Green



Two Louver
Small Hood

(1) 75W A19 max. / Medium base

Dimensions: Height 7¹/₈",
Diameter 6¹/₈"

76-632 Old Bronze

77-323 Green



Three Louver
Large Hood

(1) 100W A19 max. / Medium base

Dimensions: Height 8⁵/₈",
Diameter 9⁵/₈"

76-637 Old Bronze

76-636 Green



Two Louver
Large Hood

(1) 75W A19 max. / Medium base

Dimensions: Height 7¹/₈",
Diameter 9⁵/₈"

76-635 Old Bronze

76-634 Green



OUTDOOR



1 and 2 Light Die Cast Mounting Plates

- | | |
|-----------------------------|--------------------------------|
| 60-673 1 Light / Light Gray | 76-665 1 Light / Dark Bronze |
| 60-674 2 Light / Light Gray | 76-666 2 Light / Dark Bronze |
| 60-675 1 Light / Dark Gray | 76-667 1 Light / Antique Verdi |
| 60-676 2 Light / Dark Gray | 76-668 2 Light / Antique Verdi |



12" X 1/2" Steel Mounting Post

- Threaded on Both Ends
- 90-1278 Green Finish
 - 90-1279 Old Bronze Finish



3" Diameter PVC Mounting Post

Dimensions: Height 18", Diameter 3"

- 60-678 Dark Gray
- 60-680 Light Gray
- 76-641 Dark Bronze
- 76-664 Antique Verdi Finish



2" Diameter PVC Mounting Post

Dimensions: Height 18", Diameter 2"

- 60-677 Dark Gray
- 60-678 Light Gray
- 76-638 Green
- 76-639 Old Bronze
- 76-640 Dark Bronze
- 76-644 Antique Verdi



Incandescent Twist Lock Holders

Incandescent Maximum Wattages

10" Globes – 60 watt max.
 12" to 14" Globes – 100 watt max.
 16" Globes – 150 watt max.

- 77-692 4" Black
- 77-693 4" White
- 77-968 5 1/2" Black
- 77-969 5 1/2" White



White Acrylic Twist Lock Globe

Item #	Diameter	Fitter
50-784	10"	4"
50-785	12"	5 1/4"
50-786	14"	5 1/4"
50-787	16"	5 1/4"

Smoke Acrylic Twist Lock Globe

Item #	Diameter	Fitter
50-780	10"	4"
50-781	12"	5 1/4"
50-782	14"	5 1/4"
50-783	16"	5 1/4"



5" Round Pier Mount Bases with 3" Fitter

- 25-1206 Antique Brass
- 25-1207 Polished Brass
- 25-1208 Brushed Nickel



6" Square Pier Mount Bases with 3" Fitter

- | | |
|--------------------------|-------------------------|
| 25-1200 Textured Black | 25-4908* Rustic Bronze |
| 25-1203 Old Bronze | 25-5605* Stone Black |
| 25-1204 Old Penny Bronze | 25-5615* Classic Bronze |
| 25-1205 White | 25-5635* Aged Silver |
| 25-4023* Satin Iron Ore | 25-5645* Claret Bronze |
| 25-4024* Belgium Bronze | 25-5655* Umber Bronze |
| 25-4026* Burlwood | |

*(not shown)



Die Cast Junction Boxes (can be added to industrial style wall mount fixtures)

- 76-650 White
- 76-651 Metallic Silver
- 76-652 Old Bronze

Task Lighting.







Thread Linear LED System

Cove and under-cabinet.

Simple. Functional.
Consistent. Reliable.

Add dramatic LED lighting to any space, simply.



Connections are quick and easy with keyed connectors

- Assures proper current flow
- Makes connections simple

Power feed



Male

Female

Power connector



Male

Female

Included Accessories



Removable diffuser



Flat mounting clips



45° Mounting clips



Closed end cap

Key Features

- Available in 6", 10", 21" and 30"
- On board IC driver – no external driver required
- 2700K or 3500K
- 312 Lumens per foot at 2700K
- 330 Lumens per foot at 3500K
- CRI 80+
- Diffuser lens included for even light – eliminates hot spots and glare
- Flat mounting clips, 45° mounting clips, removable diffusing lens and closed end cap included with each unit
- Very low heat, no UV or IR radiation
- Direct-wire or portable installations – various connection accessories available
- Up to 65' continuous runs off one power feed

- Exact spacing of LEDs, including fixture to fixture for consistent, even lighting
- 50,000 hours rated life
- ENERGY STAR certified for under-cabinet and cove applications
- 5 year warranty*
- Construction: Extruded polycarbonate body and diffuser lens
- Power: 120V AC
- Light source: LED 2700K and 3500K
- Finish: White
- Dimming to less than 5% with electronic low voltage (ELV) dimmers
- Damp location listed

Item#	Description	Finish	Light Source	Watts	Volts	Length	Width	Height	Ext.	CCT	Lumens	CRI	Cert. Type
63-101†	6" Linear LED	White	LED	1.8	120	6"	1 ³ / ₁₆ "	1 ¹ / ₁₆ "	•	2700K	166*	80	Damp
63-201†	6" Linear LED	White	LED	1.8	120	6"	1 ³ / ₁₆ "	1 ¹ / ₁₆ "	•	3500K	180*	80	Damp
63-102†	10" Linear LED	White	LED	3	120	10"	1 ³ / ₁₆ "	1 ¹ / ₁₆ "	•	2700K	268*	80	Damp
63-202†	10" Linear LED	White	LED	3	120	10"	1 ³ / ₁₆ "	1 ¹ / ₁₆ "	•	3500K	278*	80	Damp
63-103†	21" Linear LED	White	LED	7	120	21"	1 ³ / ₁₆ "	1 ¹ / ₁₆ "	•	2700K	593*	80	Damp
63-203†	21" Linear LED	White	LED	7	120	21"	1 ³ / ₁₆ "	1 ¹ / ₁₆ "	•	3500K	607*	80	Damp
63-104†	30" Linear LED	White	LED	10	120	30"	1 ³ / ₁₆ "	1 ¹ / ₁₆ "	•	2700K	804*	80	Damp
63-204†	30" Linear LED	White	LED	10	120	30"	1 ³ / ₁₆ "	1 ¹ / ₁₆ "	•	3500K	833*	80	Damp

*Lumens measured at LED source.

** Consult Satco or visit www.satco.com for an up to date dimmer compatibility list.

Technical Overview

Thread internals

- Advanced on-board IC direct drive technology
- No external driver required
- No capacitor = greater reliability and longer life
- Reduced size

Linear lighting continuity

- Custom PCB (printed circuit board) layout and fixture body design maintain LED package spacing as LED fixtures are joined together

Removable diffuser lens (included)

- Softens visual glare
- Reduced reflectivity of LEDs from polished surfaces
- With lens removed lumen output increases by approximately 15%

Advanced color management

It's what makes Thread different.

- The ANSI range of 2700K is divided into 12 ranks.
- Our LED Packages only use 9 of the 12 ranks within the ANSI standard
- Without the MRM procedure, the CCT may be spread over the range inside the blue diamond.
- After MRM, the range of CCT will shrink to within the green diamond
- The Thread system, uses only 6 ranks and blends those ranks, so that the actual CCT range is much smaller and is similar to a 5-step McAdam ellipse. Ranking falls within the black dashed diamond

Patented IC Direct Drive Circuitry



Consistent 0.5" LED Package Spacing



LED Packages

Removable diffuser



MRM (Multi-Rank Mix) Diagram

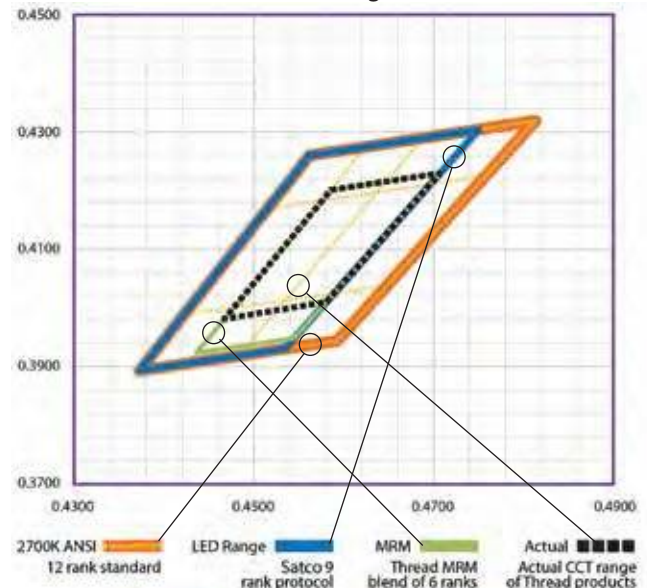



Item#	Description	Color
63-301	10' switched power cord & plug	White
63-314	Hardwire Junction Box with On/Off Rocker Switch	White
63-315	Hardwire Junction Box (no switch)	White
63-302	Direct Connector	White
63-303	2" Connecting cable	White
63-304	6" Connecting cable	White
63-305	12" Connecting cable	White
63-306	18" Connecting cable	White
63-307	24" Connecting cable	White
63-309	Cable Splitter	White
63-311	Female to Female Coupler	White

Optional Power Accessories

Junction Box Features

- Available with and without on/off side mounted rocker switch
- Supplied with 1/4" Romex connectors and rubber hole plugs
- Approved for branch circuit wiring
- Accepts 14/3 wire
- 1/2" Knockouts on back of box
- Female power connector located on side of box

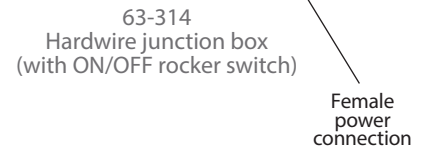
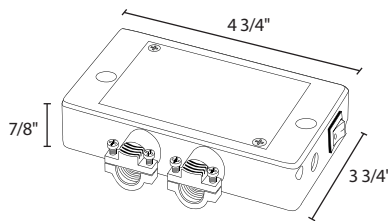
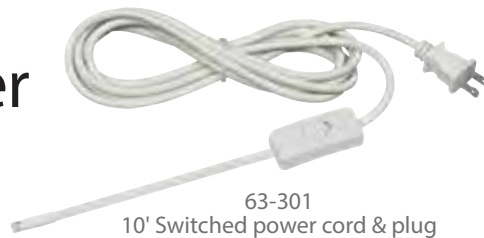

Optional Connection Accessories

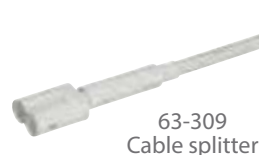
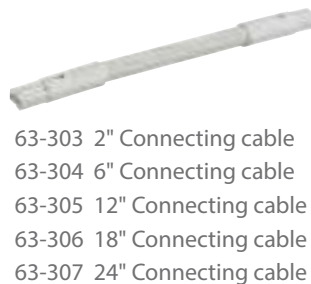
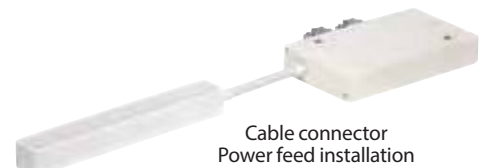

LED TRACK HEADS

White, Black or Brushed Nickel in 24° or 36° beam angles



TH401, TH403



TH405, TH407



TH402, TH404

Item#	Description	Finish	Light Source	Watts	Incand. Equiv.	Length	Width	Height	Ext.	CCT	Lumens	CRI	Cert. Type
TH401	Round 24°	White	LED	12	75W	•	3"	2 ¼"	5 ⅞"	3000K	1,020*	90	Dry
TH402	Round 24°	Black	LED	12	75W	•	3"	2 ¼"	5 ⅞"	3000K	1,020*	90	Dry
TH403	Round 36°	White	LED	12	75W	•	3"	2 ¼"	5 ⅞"	3000K	1,020*	90	Dry
TH404	Round 36°	Black	LED	12	75W	•	3"	2 ¼"	5 ⅞"	3000K	1,020*	90	Dry
TH405	Round 24°	Brushed Nickel	LED	12	75W	•	3"	2 ¼"	5 ⅞"	3000K	1,020*	90	Dry
TH407	Round 36°	Brushed Nickel	LED	12	75W	•	3"	2 ¼"	5 ⅞"	3000K	1,020*	90	Dry
TH411	Pinch Back 24°	White	LED	12	75W	•	2 ¾"	2 ¾"	5 ⅞"	3000K	1,020*	90	Dry
TH412	Pinch Back 24°	Black	LED	12	75W	•	2 ¾"	2 ¾"	5 ⅞"	3000K	1,020*	90	Dry
TH413	Pinch Back 36°	White	LED	12	75W	•	2 ¾"	2 ¾"	5 ⅞"	3000K	1,020*	90	Dry
TH414	Pinch Back 36°	Black	LED	12	75W	•	2 ¾"	2 ¾"	5 ⅞"	3000K	1,020*	90	Dry
TH415	Pinch Back 24°	Brushed Nickel	LED	12	75W	•	2 ¾"	2 ¾"	5 ⅞"	3000K	1,020*	90	Dry
TH417	Pinch Back 36°	Brushed Nickel	LED	12	75W	•	2 ¾"	2 ¼"	5 ⅞"	3000K	1,020*	90	Dry

*Lumens measured at LED source.

3 Conductor "H" type system.



TH411, TH413



TH415, TH417



TH412, TH414

LED TRACK HEADS

White, Black or Brushed Nickel in 24° or 36° beam angles

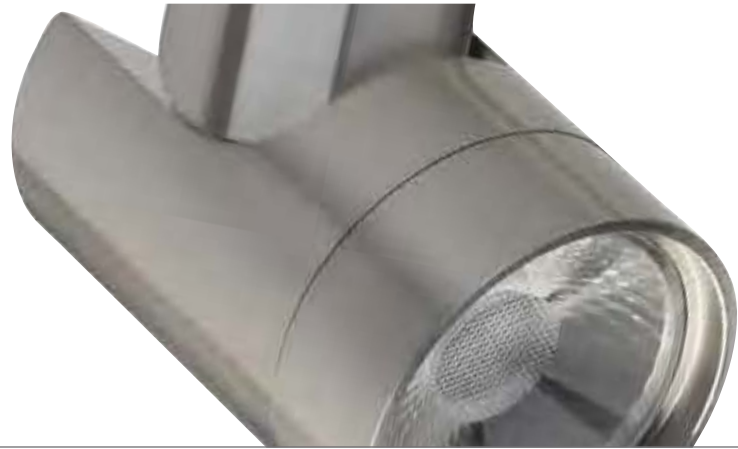

TH421, TH423



TH425, TH427



TH422, TH424

Item#	Description	Finish	Light Source	Watts	Incand. Equiv.	Length	Width	Height	Ext.	CCT	Lumens	CRI	Cert. Type
TH421	Angle Arm 24°	White	LED	12	75W	•	2 1/2"	2 3/8"	6 1/4"	3000K	1,020*	90	Dry
TH422	Angle Arm 24°	Black	LED	12	75W	•	2 1/2"	2 3/8"	6 1/4"	3000K	1,020*	90	Dry
TH423	Angle Arm 36°	White	LED	12	75W	•	2 1/2"	2 3/8"	6 1/4"	3000K	1,020*	90	Dry
TH424	Angle Arm 36°	Black	LED	12	75W	•	2 1/2"	2 3/8"	6 1/4"	3000K	1,020*	90	Dry
TH425	Angle Arm 24°	Brushed Nickel	LED	12	75W	•	2 1/2"	2 3/8"	6 1/4"	3000K	1,020*	90	Dry
TH427	Angle Arm 36°	Brushed Nickel	LED	12	75W	•	2 1/2"	2 3/8"	6 1/4"	3000K	1,020*	90	Dry
TH431	Barrel 24°	White	LED	12	75W	•	2 1/4"	3 1/4"	5"	3000K	1,020*	90	Dry
TH432	Barrel 24°	Black	LED	12	75W	•	2 1/4"	3 1/4"	5"	3000K	1,020*	90	Dry
TH433	Barrel 36°	White	LED	12	75W	•	2 1/4"	3 1/4"	5"	3000K	1,020*	90	Dry
TH434	Barrel 36°	Black	LED	12	75W	•	2 1/4"	3 1/4"	5"	3000K	1,020*	90	Dry
TH435	Barrel 24°	Brushed Nickel	LED	12	75W	•	2 1/4"	3 1/4"	5"	3000K	1,020*	90	Dry
TH437	Barrel 36°	Brushed Nickel	LED	12	75W	•	2 1/4"	3 1/4"	5"	3000K	1,020*	90	Dry

*Lumens measured at LED source.

3 Conductor "H" type system.



TH431, TH433



TH435, TH437



TH432, TH434

LED TRACK HEADS

White, Black or Brushed Nickel in 24° or 36° beam angles



TH441, TH443



TH445, TH447



TH442, TH444

Item#	Description	Finish	Light Source	Watts	Incand. Equiv.	Length	Width	Height	Ext.	CCT	Lumens	CRI	Cert. Type
TH441	Pipe 24°	White	LED	12	75W	•	2 3/8"	2 3/8"	5 3/16"	3000K	1,020*	90	Dry
TH442	Pipe 24°	Black	LED	12	75W	•	2 3/8"	2 3/8"	5 3/16"	3000K	1,020*	90	Dry
TH443	Pipe 36°	White	LED	12	75W	•	2 3/8"	2 3/8"	5 3/16"	3000K	1,020*	90	Dry
TH444	Pipe 36°	Black	LED	12	75W	•	2 3/8"	2 3/8"	5 3/16"	3000K	1,020*	90	Dry
TH445	Pipe 24°	Brushed Nickel	LED	12	75W	•	2 3/8"	2 3/8"	5 3/16"	3000K	1,020*	90	Dry
TH447	Pipe 36°	Brushed Nickel	LED	12	75W	•	2 3/8"	2 3/8"	5 3/16"	3000K	1,020*	90	Dry
TH451	Taper Back 24°	White	LED	12	75W	•	2 13/16"	3 1/4"	5 1/4"	3000K	1,020*	90	Dry
TH452	Taper Back 24°	Black	LED	12	75W	•	2 13/16"	3 1/4"	5 1/4"	3000K	1,020*	90	Dry
TH453	Taper Back 36°	White	LED	12	75W	•	2 13/16"	3 1/4"	5 1/4"	3000K	1,020*	90	Dry
TH454	Taper Back 36°	Black	LED	12	75W	•	2 13/16"	3 1/4"	5 1/4"	3000K	1,020*	90	Dry
TH455	Taper Back 24°	Brushed Nickel	LED	12	75W	•	2 13/16"	3 1/4"	5 1/4"	3000K	1,020*	90	Dry
TH457	Taper Back 36°	Brushed Nickel	LED	12	75W	•	2 13/16"	3 1/4"	5 1/4"	3000K	1,020*	90	Dry

*Lumens measured at LED source.

3 Conductor "H" type system.



TH451, TH453



TH455, TH457



TH452, TH454

LED TRACK HEADS

White, Black or Brushed Nickel in 24° or 36° beam angles



TH461, TH463



TH465, TH467



TH462, TH464

Item#	Description	Finish	Light Source	Watts	Incand. Equiv.	Length	Width	Height	Ext.	CCT	Lumens	CRI	Cert. Type
TH461	Square 24°	White	LED	12	75W	•	2 3/8"	2 3/4"	5 3/16"	3000K	1,020*	90	Dry
TH462	Square 24°	Black	LED	12	75W	•	2 3/8"	2 3/4"	5 3/16"	3000K	1,020*	90	Dry
TH463	Square 36°	White	LED	12	75W	•	2 3/8"	2 3/4"	5 3/16"	3000K	1,020*	90	Dry
TH464	Square 36°	Black	LED	12	75W	•	2 3/8"	2 3/4"	5 3/16"	3000K	1,020*	90	Dry
TH465	Square 24°	Brushed Nickel	LED	12	75W	•	2 3/8"	2 3/4"	5 3/16"	3000K	1,020*	90	Dry
TH467	Square 36°	Brushed Nickel	LED	12	75W	•	2 3/8"	2 3/4"	5 3/16"	3000K	1,020*	90	Dry
TH471	Small Cylinder 24°	White	LED	12	75W	•	2 3/16"	3 1/2"	5 3/16"	3000K	1,020*	90	Dry
TH472	Small Cylinder 24°	Black	LED	12	75W	•	2 3/16"	3 1/2"	5 3/16"	3000K	1,020*	90	Dry
TH473	Small Cylinder 36°	White	LED	12	75W	•	2 3/16"	3 1/2"	5 3/16"	3000K	1,020*	90	Dry
TH474	Small Cylinder 36°	Black	LED	12	75W	•	2 3/16"	3 1/2"	5 3/16"	3000K	1,020*	90	Dry
TH475	Small Cylinder 24°	Brushed Nickel	LED	12	75W	•	2 3/16"	3 1/2"	5 3/16"	3000K	1,020*	90	Dry
TH477	Small Cylinder 36°	Brushed Nickel	LED	12	75W	•	2 3/16"	3 1/2"	5 3/16"	3000K	1,020*	90	Dry

*Lumens measured at LED source.

3 Conductor "H" type system.



TH471, TH473



TH475, TH477



TH472, TH474

LED 4' TRACK KITS

White, Black or Brushed Nickel in 36° beam angles



Kits Include

- 4' track with end caps
- 3 Track heads
- Floating canopy power feed
- All necessary mounting hardware



3 Conductor "H"
type connector



Track with end
cap removed



TK403



TK404



TK407

Item#	Description	Finish	Light Source	Tot. Watts	Incand. Equiv.	Track Length	Head Width	Head Height	Head Ext.	CCT	Tot. Lumens	CRI	Cert. Type
TK403	Round 36°	White	LED	36	3x75W	48"	3"	2 1/4"	5 1/8"	3000K	3,060*	90	Dry
TK404	Round 36°	Black	LED	36	3x75W	48"	3"	2 1/4"	5 1/8"	3000K	3,060*	90	Dry
TK407	Round 36°	Brushed Nickel	LED	36	3x75W	48"	3"	2 1/4"	5 1/8"	3000K	3,060*	90	Dry
TK413	Pinch Back 36°	White	LED	36	3x75W	48"	2 3/4"	2 3/4"	5 5/8"	3000K	3,060*	90	Dry
TK414	Pinch Back 36°	Black	LED	36	3x75W	48"	2 3/4"	2 3/4"	5 5/8"	3000K	3,060*	90	Dry
TK417	Pinch Back 36°	Brushed Nickel	LED	36	3x75W	48"	2 3/4"	2 3/4"	5 5/8"	3000K	3,060*	90	Dry
TK423	Angle Arm 36°	White	LED	36	3x75W	48"	2 1/2"	2 3/8"	6 1/4"	3000K	3,060*	90	Dry
TK424	Angle Arm 36°	Black	LED	36	3x75W	48"	2 1/2"	2 3/8"	6 1/4"	3000K	3,060*	90	Dry
TK427	Angle Arm 36°	Brushed Nickel	LED	36	3x75W	48"	2 1/2"	2 3/8"	6 1/4"	3000K	3,060*	90	Dry

*Lumens measured at LED source.

3 Conductor "H" type system.



TK413



TK417



TK414



TK423



TK427



TK424

4' TRACK KITS

4 Ft. Linear Track Kits Include:

- (1) Floating power feed canopy kit
- (1) Four foot track
- (3) Track lighting heads
- All necessary mounting hardware
- Four color display carton



PAR30 Gimbal Ring

(3) PAR30 (Shortneck) 75W max. / Medium Base

TK316 White



TK317 Black

TK343 Brushed Nickel

TK362 Russet Bronze



R30 Straight Cylinder

(3) R30/PAR30 (Longneck) 75W max. / Medium Base

TK318 White



TK319 Black

TK341 Brushed Nickel



R30 Step Cylinder

(3) R30/PAR30 (Longneck) 75W max. / Medium Base

TK320 White



TK321 Black

TK340 Brushed Nickel

TK361 Russet Bronze



R30 Bullet Cylinder

(3) R30/PAR30 (Longneck) 75W max. / Medium Base

TK322 White



TK323 Black

TK342 Brushed Nickel

Linear track kits supplied with floating canopy kit.



MR16 Square

(3) 50W MR16 / GU10 base 120V max.

TK345 White



TK346 Black

TK347 Brushed Nickel



MR16 Round Back

(3) 50W MR16 / GU10 base 120V max.

TK348 White



TK349 Black

TK354 Brushed Nickel



MR16 Gimbal Ring

(3) 50W MR16 / GU10 base 120V max.

TK355 White



TK352 Black

TK353 Brushed Nickel



12V MR16 Square

(3) 50W MR16 / GX5.3 base 12V max.

TK310 White



TK315 Black

TRACK HEADS

R20 Step Cylinder

Dimensions: Height 5 ¼", Width 3 ½", Extension 7 ½"

(1) R20/PAR20 50W max. / Medium Base

TH204 White

TH205 Black

TH303 Brushed Nickel

TH341 Russet Bronze (shown)



R20 Straight Cylinder

Dimensions: Height 6 ½", Width 4 ¼", Extension 9 ½"

(1) R20/PAR20 50W max. / Medium Base

TH200 White

TH201 Black

TH307 Brushed Nickel (shown)

TH343 Russet Bronze



R20 Bullet Cylinder

Dimensions: Height 6", Width 3 ½", Extension 8"

(1) R20/PAR20 50W max. / Medium Base

TH208 White

TH209 Black (shown)

TH305 Brushed Nickel

TH345 Russet Bronze



R30 Step Cylinder

Dimensions: Height 6 ½", Width 4 ½", Extension 8 ½"

(1) R30/PAR30 75W max. (Long Neck) / Medium Base

TH206 White

TH207 Black

TH304 Brushed Nickel (shown)

TH342 Russet Bronze



R30 Straight Cylinder

Dimensions: Height 7", Width 4 ½", Extension 9 ½"

(1) R30/PAR30 75W max. (Long Neck) / Medium Base

TH202 White

TH203 Black

TH308 Brushed Nickel

TH344 Russet Bronze (shown)



R30 Bullet Cylinder

Dimensions: Height 7", Width 4 1/2", Extension 9"
(1) R30/PAR30 75W max. (Long Neck) / Medium Base
TH210 White (shown)
TH211 Black
TH306 Brushed Nickel
TH346 Russet Bronze



PAR20 Short Bullet Cylinder

Dimensions: Height 4 1/2", Width 3 1/2", Extension 7"
(1) PAR20 50W max. / Medium Base
TH216 White (shown)
TH217 Black



PAR30 Short Bullet Cylinder

Dimensions: Height 5 1/8", Width 4 1/2", Extension 8"
(1) PAR30 75W max. / (short neck) Medium Base
TH218 White
TH219 Black (shown)



PAR20 Gimbal Ring

Dimensions: Height 4 1/2", Width 2 3/4", Extension 6 3/4"
(1) PAR20 50W max. / Medium Base
TH220 White
TH221 Black
TH300 Brushed Nickel (shown)
TH347 Russet Bronze



PAR30 Gimbal Ring

Dimensions: Height 4 3/4", Width 4", Extension 10 1/2"
(1) PAR30 75W max. / (short neck) Medium Base
TH222 White (shown)
TH223 Black
TH301 Brushed Nickel
TH348 Russet Bronze



TRACK HEADS

PAR38 Gimbal Ring

Dimensions: Height 6¹/₄", Width 5", Extension 10¹/₂"

(1) PAR20 50W max. / Medium Base

TH224 White

TH225 Black (shown)

TH302 Brushed Nickel

TH349 Russet Bronze



PAR30 Euro Style

Dimensions: Height 7¹/₂", Width 4¹/₂", Extension 8¹/₂"

(1) PAR30 75W max. / (short neck) Medium Base

TH332 White

TH333 Black

TH331 Brushed Nickel
(shown)



R40 Straight Cylinder

Dimensions: Height 8", Width 5¹/₂", Extension 12"

(1) 150W BR40/PAR38/BR38 max. / Medium Base

TH283 White (shown)

TH284 Black



Universal Holder

Dimensions: Height 4³/₄", Width 2",
Extension 7" (without lamp)

(1) R20/BR30/BR40/PAR20 /PAR30/PAR38
150W.max. / Medium Base

TH226 White

TH227 Black

TH324 Brushed Nickel (shown)



Mini Universal Holder

Dimensions: Height 4³/₄", Width 2",
Extension 7" (without lamp)

(1) R20/BR30/BR40/PAR20 /PAR30/ PAR38
150W.max. / Medium Base

TH279 White

TH280 Black (shown)



MR16 Square

Dimensions: Height 3 1/4", Width 2 1/4", Extension 6 1/2"
(1) 50W MR16 / GU10 base 120V max.

TH312 White

TH313 Black (shown)

TH314 Brushed Nickel



MR16 Roundback

Dimensions: Height 3 1/4", Width 2 1/4", Extension 6 1/2"
(1) 50W MR16 / GU10 base 120V max.

TH315 White

TH316 Black

TH317 Brushed Nickel (shown)

TH351 Russet Bronze



MR16 Gimbal Ring

Dimensions: Height 2 1/4", Width 2", Extension 4 1/2"
(1) 50W MR16 / GU10 base 120V max.

TH321 White

TH322 Black

TH323 Brushed Nickel

TH352 Russet Bronze (shown)



12V MR16 Square

Dimensions: Height 3 1/4", Width 2 1/4", Extension 6 1/2"
(1) 50W MR16 12V max. / GX5.3 Base

TH232 White (shown)

TH233 Black



12V MR16 Round

Dimensions: Height 3 1/4", Width 2 1/4", Extension 6 1/2"
(1) 50W MR16 12V max. / GX5.3 Base

TH234 White

TH235 Black (shown)



12V MR16 Gimbal Ring

Dimensions: Height 2 1/4", Width 2", Extension 6 1/2"
(1) 50W MR16 12V max. / GX5.3 Base

TH238 White (shown)

TH239 Black



TRACK & ACCESSORIES



Track Power Feeds & Connectors



Floating Canopy

Electrifies the track anywhere along the length of the run

TP154 White
TP155 Black
TP202 Brown



Conduit Live End

Electrifies the track from the end of the run to a conduit pipe

TP169 White
TP170 Black
TP203 Brown



Live End and Canopy

Electrifies the track from the end of the run

TP152 White
TP153 Black
TP204 Brown



Inline Feed

Connects tracks in a straight run and supplies power

TP171 White
TP172 Black
TP211 Brown



Straight Connector

Connects tracks in a straight run

TP144 White
TP145 Black
TP205 Brown



"L" Connector

Connects tracks at a 90° angle

TP146 White
TP147 Black
TP208 Brown

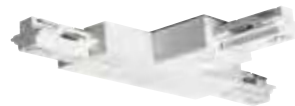

"T" Connector

Connects three tracks together in a "T" shape pattern

TP148 White
TP149 Black
TP207 Brown



"X" Connector

Connects four tracks together in an "X" shape pattern

TP150 White
TP151 Black
TP206 Brown



Flexible Connector

Variable angle connector

TP167 White
TP168 Black
TP209 Brown



Live End Cord Kit

Electrifies the track from the end of the run, supplied with 15' of two conductor wire and line switch

TP156 White
TP157 Black
TP201 Brown



Pendant Track Adapter

Connects pendant (corded) to track.

- Supports up to 10 lbs max
- For SVT 18/3 wire

TP231 White
TP232 Black
TP233 Brown

Item#	Description	Finish	Length	Width	Height	Cert.
TR118	2 Foot Track, 2 dead end caps, all mounting hardware	White	24"	1 5/16"	5/8"	Dry
TR119	2 Foot Track, 2 dead end caps, all mounting hardware	Black	24"	1 5/16"	5/8"	Dry
TR120	4 Foot Track, 2 dead end caps, all mounting hardware	White	48"	1 5/16"	5/8"	Dry
TR121	4 Foot Track, 2 dead end caps, all mounting hardware	Black	48"	1 5/16"	5/8"	Dry
TR122	8 Foot Track, 2 dead end caps, all mounting hardware	White	96"	1 5/16"	5/8"	Dry
TR123	8 Foot Track, 2 dead end caps, all mounting hardware	Black	96"	1 5/16"	5/8"	Dry
TR124	6 Foot Track, 2 dead end caps, all mounting hardware	White	72"	1 5/16"	5/8"	Dry
TR125	6 Foot Track, 2 dead end caps, all mounting hardware	Black	72"	1 5/16"	5/8"	Dry
TR126	2 Foot Track, 2 dead end caps, all mounting hardware	Brushed Nickel	24"	1 5/16"	5/8"	Dry
TR127	4 Foot Track, 2 dead end caps, all mounting hardware	Brushed Nickel	48"	1 5/16"	5/8"	Dry
TR128	6 Foot Track, 2 dead end caps, all mounting hardware	Brushed Nickel	72"	1 5/16"	5/8"	Dry
TR129	8 Foot Track, 2 dead end caps, all mounting hardware	Brushed Nickel	96"	1 5/16"	5/8"	Dry
TR131	2 Foot Track, 2 dead end caps, all mounting hardware	Russet Bronze	24"	1 5/16"	5/8"	Dry
TR132	4 Foot Track, 2 dead end caps, all mounting hardware	Russet Bronze	48"	1 5/16"	5/8"	Dry
TR133	6 Foot Track, 2 dead end caps, all mounting hardware	Russet Bronze	72"	1 5/16"	5/8"	Dry
TR134	8 Foot Track, 2 dead end caps, all mounting hardware	Russet Bronze	96"	1 5/16"	5/8"	Dry

Tracks

Includes two dead end caps and all mounting hardware.



Used with 3 Conductor "H" type connector

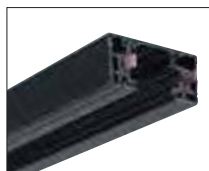

Track with end cap removed



White Baffle

Replaces standard black baffle

TP180 White, for R20 or PAR20 round cylinders

TP181 White, for R30, BR30 or PAR 30 round cylinders

Extensions

Lowers track heads to desired height

Size	White	Black
18 IN	TP159	TP163
24 IN	TP160	TP164
36 IN	TP161	TP165
48 IN	TP162	TP166

Line Voltage (120V)

Monopoint Adapters

Individually mounts a single track head to a junction box

TP142 White

TP143 Black



Low Voltage (12V)

Monopoint Adapters

Offset monopoint for low voltage track heads

TP176 White

TP177 Black



TP159 18" extension shown with PAR38 track head and 120V monopoint adapter

24" Pendant Suspension Kit

Kit Includes: canopy, stem, support and power feed accessories

TP178 White

TP179 Black



INDEX

25-1200	555	60-272	380	60-345	416	60-537	538
25-1203	555	60-273	380	60-346	416	60-538	538
25-1204	555	60-274	381	60-347	416	60-539	538
25-1205	555	60-275	381	60-348	419	60-540	534
25-1206	555	60-276	381	60-349	419	60-541	534
25-1207	555	60-277	381	60-350	419	60-542	534
25-1208	555	60-280	370	60-351	419	60-546	535
25-4023	555	60-281	370	60-352	420	60-547	535
25-4024	555	60-282	370	60-353	420	60-548	535
25-4026	555	60-283	368	60-354	420	60-607	178
25-4091	295, 297	60-284	368	60-355	420	60-608	178
25-4908	555	60-285	368	60-356	357	60-609	178
25-5605	555	60-290	413	60-357	358	60-610	178
25-5615	555	60-291	406	60-358	356	60-611	179
25-5635	555	60-292	408	60-359	358	60-612	179
25-5645	555	60-293	411	60-360	357	60-613	179
25-5655	555	60-294	412	60-362	356	60-614	179
50-780	555	60-295	390	60-365	402	60-615	179
50-781	555	60-296	427	60-366	402	60-630	536
50-782	555	60-297	427	60-367	403	60-631	536
50-783	555	60-298	427	60-368	403	60-632	536
50-784	555	60-299	427	60-370	400	60-633	536
50-785	555	60-300	422	60-371	400	60-634	536
50-786	555	60-301	422	60-378	260	60-635	536
50-787	555	60-302	422	60-380	260	60-636	537
60-044	432	60-303	422	60-381	261	60-637	537
60-181	359	60-304	423	60-382	262	60-638	537
60-182	359	60-305	423	60-383	263	60-639	537
60-183	360	60-306	423	60-384	263	60-640	537
60-184	360	60-307	423	60-385	261	60-641	537
60-185	361	60-308	425	60-386	260	60-673	554
60-186	361	60-309	425	60-387	263	60-674	554
60-187	361	60-310	425	60-388	263	60-675	554
60-188	361	60-311	425	60-390	398	60-676	554
60-189	358	60-312	426	60-391	398	60-677	554
60-190	358	60-313	426	60-392	399	60-678	554
60-191	359	60-314	426	60-393	399	60-679	554
60-192	359	60-315	426	60-394	398	60-680	554
60-197	368	60-316	413	60-395	398	60-712	390
60-198	368	60-317	413	60-470	546	60-885	530
60-199	368	60-318	413	60-471	546	60-886	530
60-200	364	60-319	413	60-472	546	60-887	530
60-201	364	60-320	406	60-473	546	60-888	528
60-202	364	60-321	406	60-487	535	60-889	528
60-203	396	60-322	406	60-488	535	60-890	528
60-204	396	60-323	406	60-489	535	60-891	529
60-205	370	60-324	408	60-516	540	60-892	529
60-206	370	60-325	408	60-517	540	60-893	529
60-207	370	60-326	408	60-518	541	60-894	531
60-208	365	60-327	408	60-519	541	60-895	531
60-209	365	60-328	411	60-520	539	60-896	531
60-210	365	60-329	411	60-521	539	60-897	531
60-211	397	60-330	411	60-522	539	60-898	531
60-212	397	60-331	411	60-523	539	60-899	531
60-213	372	60-332	412	60-524	539	60-985	532
60-214	372	60-333	412	60-525	539	60-986	532
60-215	372	60-334	412	60-526	540	60-987	532
60-221	373	60-335	412	60-527	540	60-988	532
60-222	373	60-336	421	60-528	541	60-989	532
60-223	373	60-337	421	60-529	541	60-990	532
60-245	389	60-338	421	60-530	540	60-991	533
60-247	389	60-339	421	60-531	540	60-992	533
60-255	381	60-340	414	60-532	541	60-993	533
60-257	380	60-341	414	60-533	541	60-994	533
60-259	380	60-342	414	60-534	538	60-995	533
60-270	380	60-343	414	60-535	538	60-996	533
60-271	380	60-344	416	60-536	538	60-1021	256

60-1023	256	60-1849	396	60-3176	371	60-4186	164
60-1024	257	60-1851	402	60-3177	371	60-4187	166
60-1025	257	60-1852	405	60-3240	360	60-4188	166
60-1026	258	60-1853	405	60-3241	360	60-4191	165
60-1027	258	60-1854	405	60-3242	358	60-4192	165
60-1028	257	60-1855	405	60-3243	358	60-4193	165
60-1029	256	60-2641	387	60-3244	364	60-4194	165
60-1031	259	60-2642	387	60-3245	364	60-4261	147
60-1032	259	60-2643	387	60-3246	364	60-4262	147
60-1035	259	60-2644	387	60-3247	397	60-4263	147
60-1036	259	60-2645	387	60-3248	397	60-4264	147
60-1037	258	60-2646	387	60-3249	389	60-4265	145
60-1038	258	60-2851	171	60-3255	357	60-4266	145
60-1251	361	60-2853	170	60-3256	357	60-4267	144
60-1252	361	60-2855	168	60-3257	402	60-4268	145
60-1255	372	60-2857	169	60-3258	398	60-4269	144
60-1256	372	60-2859	169	60-3259	398	60-4271	146
60-1257	372	60-2862	169	60-3261	369	60-4272	146
60-1264	410	60-2864	169	60-3262	369	60-4273	146
60-1265	410	60-2866	170	60-3263	369	60-4431	122
60-1266	410	60-2868	171	60-3264	415	60-4433	122
60-1267	410	60-2871	171	60-3265	415	60-4436	123
60-1268	410	60-2873	171	60-3266	415	60-4437	123
60-1269	418	60-2875	171	60-3271	369	60-4438	123
60-1271	418	60-2932	295	60-3272	369	60-4439	123
60-1272	418	60-2934	294	60-3273	369	60-4441	120
60-1273	418	60-2936	294	60-3277	415	60-4443	120
60-1274	356	60-2938	294	60-3278	407	60-4446	121
60-1276	399	60-2971	175	60-3279	407	60-4447	121
60-1277	403	60-2972	175	60-3281	407	60-4448	121
60-1279	381	60-2973	175	60-3282	407	60-4449	121
60-1284	424	60-2974	175	60-3283	407	60-4454	125
60-1285	424	60-2975	174	60-4001	163	60-4458	125
60-1286	424	60-2976	175	60-4002	163	60-4459	125
60-1287	424	60-2977	174	60-4003	163	60-4464	124
60-1290	363	60-2978	173	60-4004	163	60-4468	124
60-1291	363	60-2979	172	60-4005	162	60-4469	124
60-1298	363	60-2981	173	60-4006	162	60-4581	159
60-1701	264	60-2982	173	60-4007	162	60-4582	159
60-1702	264	60-2983	173	60-4009	163	60-4583	159
60-1703	265	60-3141	360	60-4081	161	60-4584	159
60-1707	265	60-3142	360	60-4082	161	60-4585	156
60-1708	264	60-3143	359	60-4083	161	60-4586	156
60-1709	265	60-3144	359	60-4084	161	60-4587	158
60-1711	265	60-3145	371	60-4085	160	60-4588	158
60-1821	354	60-3146	371	60-4086	160	60-4591	157
60-1822	354	60-3147	371	60-4087	160	60-4592	157
60-1823	354	60-3148	365	60-4088	160	60-4593	157
60-1824	367	60-3149	365	60-4091	161	60-4620	103
60-1825	367	60-3151	365	60-4141	151	60-4621	105
60-1826	367	60-3152	397	60-4142	151	60-4622	105
60-1827	366	60-3153	397	60-4143	151	60-4623	105
60-1828	396	60-3155	409	60-4144	151	60-4624	103
60-1829	396	60-3161	409	60-4145	149	60-4625	104
60-1831	402	60-3162	409	60-4146	149	60-4626	103
60-1832	404	60-3163	409	60-4147	150	60-4627	105
60-1833	404	60-3164	409	60-4148	148	60-4628	104
60-1834	404	60-3165	417	60-4149	148	60-4629	105
60-1835	404	60-3166	417	60-4151	149	60-4630	102
60-1841	355	60-3167	417	60-4152	150	60-4641	177
60-1842	355	60-3168	417	60-4153	150	60-4642	177
60-1843	355	60-3169	356	60-4154	150	60-4643	177
60-1844	367	60-3171	356	60-4181	167	60-4644	177
60-1845	367	60-3172	402	60-4182	167	60-4645	176
60-1846	367	60-3173	399	60-4183	167	60-4647	176
60-1847	366	60-3174	399	60-4184	167	60-4648	176
60-1848	396	60-3175	371	60-4185	164	60-4651	177

INDEX

60-4652	177	60-4912	519	60-5136	236	60-5402	64
60-4681	183	60-4913	519	60-5137	238	60-5403	65
60-4682	183	60-4921	520	60-5138	238	60-5404	64
60-4683	183	60-4922	520	60-5139	236	60-5405	65
60-4684	183	60-4923	520	60-5141	238	60-5406	63
60-4685	182	60-4924	520	60-5142	237	60-5407	62
60-4686	181	60-4925	520	60-5143	237	60-5408	62
60-4687	182	60-4926	520	60-5144	238	60-5409	63
60-4688	182	60-4927	521	60-5171	336	60-5411	62
60-4689	180	60-4928	521	60-5172	336	60-5412	64
60-4691	181	60-4929	521	60-5173	336	60-5413	65
60-4692	181	60-4931	521	60-5174	336	60-5414	64
60-4720	107	60-4932	521	60-5177	338	60-5415	65
60-4721	109	60-4933	521	60-5178	338	60-5416	63
60-4722	109	60-4951	527	60-5181	337	60-5450	140
60-4723	109	60-4952	527	60-5182	337	60-5451	141
60-4724	107	60-4953	527	60-5183	337	60-5452	141
60-4725	108	60-4954	527	60-5184	337	60-5453	141
60-4726	107	60-4955	527	60-5187	339	60-5454	141
60-4727	109	60-4956	527	60-5188	339	60-5455	141
60-4728	108	60-4957	526	60-5201	131	60-5456	140
60-4729	109	60-4958	526	60-5202	131	60-5457	140
60-4730	106	60-4959	526	60-5203	131	60-5458	140
60-4731	129	60-4961	524	60-5204	131	60-5460	140
60-4732	129	60-4962	524	60-5205	130	60-5471	137
60-4733	129	60-4963	524	60-5206	130	60-5472	137
60-4734	129	60-4964	524	60-5207	130	60-5473	137
60-4735	128	60-4965	524	60-5261	48	60-5474	137
60-4736	127	60-4966	524	60-5262	48	60-5475	136
60-4737	127	60-4967	522	60-5263	48	60-5476	136
60-4738	128	60-4968	522	60-5264	48	60-5477	136
60-4739	126	60-4969	522	60-5265	48	60-5478	137
60-4741	127	60-4971	523	60-5301	133	60-5486	366
60-4751	115	60-4972	523	60-5302	133	60-5491	155
60-4752	115	60-4973	523	60-5303	133	60-5492	155
60-4753	115	60-4974	525	60-5304	133	60-5493	155
60-4754	115	60-4975	525	60-5305	132	60-5494	155
60-4755	114	60-4976	525	60-5306	132	60-5495	154
60-4756	113	60-4977	525	60-5307	132	60-5496	154
60-4757	114	60-4978	525	60-5329	185	60-5497	155
60-4758	113	60-4979	525	60-5331	184	60-5498	155
60-4759	112	60-5031	235	60-5332	185	60-5499	154
60-4761	113	60-5032	235	60-5333	185	60-5501	66
60-4801	391	60-5033	235	60-5334	184	60-5502	68
60-4802	391	60-5034	235	60-5335	186	60-5503	69
60-4804	391	60-5035	233	60-5336	187	60-5504	68
60-4851	119	60-5036	232	60-5337	187	60-5505	69
60-4852	119	60-5037	234	60-5338	186	60-5506	67
60-4853	119	60-5038	234	60-5339	187	60-5507	66
60-4854	119	60-5039	232	60-5361	49	60-5508	66
60-4855	118	60-5041	234	60-5362	49	60-5509	67
60-4856	117	60-5042	233	60-5363	49	60-5511	66
60-4857	118	60-5043	233	60-5364	49	60-5512	68
60-4858	117	60-5044	234	60-5365	49	60-5513	69
60-4859	116	60-5101	153	60-5372	147	60-5514	68
60-4861	117	60-5102	153	60-5373	162	60-5515	69
60-4901	518	60-5103	153	60-5374	433	60-5516	67
60-4902	518	60-5104	152	60-5375	433	60-5541	61
60-4903	518	60-5105	153	60-5376	433	60-5542	61
60-4904	518	60-5106	153	60-5377	433	60-5543	61
60-4905	518	60-5107	152	60-5378	432	60-5544	60
60-4906	518	60-5108	152	60-5379	432	60-5545	60
60-4907	519	60-5131	239	60-5381	432	60-5546	60
60-4908	519	60-5132	239	60-5382	432	60-5547	61
60-4909	519	60-5133	239	60-5383	433	60-5548	61
60-4911	519	60-5134	239	60-5384	432	60-5550	142
		60-5135	237	60-5401	62	60-5551	143

60-5552	143	60-5694	231	60-5849	305	60-5977	253
60-5553	143	60-5695	230	60-5851	83	60-6121	47
60-5554	143	60-5696	230	60-5852	82	60-6122	47
60-5555	143	60-5697	229	60-5853	83	60-6123	47
60-5556	142	60-5699	228	60-5854	82	60-6124	46
60-5557	142	60-5700	229	60-5855	83	60-6125	44
60-5558	142	60-5711	70	60-5856	81	60-6126	45
60-5560	142	60-5712	70	60-5857	80	60-6127	45
60-5571	139	60-5713	70	60-5858	81	60-6128	44
60-5572	139	60-5715	70	60-5859	80	60-6129	47
60-5573	139	60-5721	71	60-5860	81	60-6131	37
60-5574	139	60-5722	71	60-5871	243	60-6132	36
60-5575	138	60-5723	71	60-5872	241	60-6133	37
60-5576	138	60-5725	71	60-5874	251	60-6134	36
60-5577	138	60-5761	74	60-5875	249	60-6135	36
60-5578	139	60-5762	74	60-5876	249	60-6201	199
60-5586	366	60-5763	75	60-5877	249	60-6202	199
60-5590	225	60-5764	74	60-5881	92	60-6203	199
60-5591	227	60-5765	75	60-5882	93	60-6204	199
60-5592	227	60-5766	75	60-5883	92	60-6205	197
60-5593	227	60-5767	75	60-5884	93	60-6207	197
60-5594	227	60-5771	76	60-5885	93	60-6208	198
60-5595	226	60-5772	76	60-5886	94	60-6209	196
60-5596	226	60-5773	77	60-5887	95	60-6211	197
60-5597	225	60-5774	76	60-5888	94	60-6212	196
60-5599	224	60-5775	77	60-5889	95	60-6213	198
60-5600	225	60-5776	77	60-5890	95	60-6221	207
60-5601	512	60-5777	77	60-5891	54	60-6222	207
60-5602	512	60-5791	57	60-5892	55	60-6223	207
60-5603	512	60-5792	57	60-5893	55	60-6224	207
60-5604	513	60-5793	57	60-5894	55	60-6225	205
60-5605	513	60-5794	56	60-5895	54	60-6226	205
60-5606	513	60-5795	57	60-5896	98	60-6227	204
60-5611	510	60-5800	240	60-5897	99	60-6228	206
60-5612	510	60-5801	243	60-5898	98	60-6229	204
60-5613	510	60-5802	243	60-5899	99	60-6231	205
60-5614	511	60-5803	243	60-5900	244	60-6241	215
60-5615	511	60-5804	242	60-5901	247	60-6242	215
60-5616	511	60-5805	241	60-5902	247	60-6243	215
60-5621	508	60-5806	242	60-5903	247	60-6244	215
60-5622	508	60-5807	242	60-5904	246	60-6245	213
60-5623	508	60-5808	242	60-5905	245	60-6246	213
60-5624	509	60-5809	240	60-5906	246	60-6247	214
60-5625	509	60-5821	251	60-5907	246	60-6248	214
60-5626	509	60-5822	251	60-5908	246	60-6249	212
60-5641	506	60-5823	251	60-5909	244	60-6251	212
60-5642	506	60-5824	250	60-5921	255	60-6252	213
60-5643	506	60-5825	248	60-5922	255	60-6253	214
60-5644	507	60-5826	250	60-5923	255	60-6261	84
60-5645	507	60-5827	250	60-5924	254	60-6262	84
60-5646	507	60-5828	250	60-5925	252	60-6263	84
60-5651	504	60-5829	248	60-5926	254	60-6271	89
60-5652	504	60-5831	490	60-5927	254	60-6272	89
60-5653	504	60-5832	490	60-5928	254	60-6273	89
60-5654	505	60-5833	490	60-5929	252	60-6281	88
60-5655	505	60-5834	491	60-5931	111	60-6282	88
60-5656	505	60-5835	491	60-5937	111	60-6283	88
60-5671	492	60-5836	491	60-5942	111	60-6291	73
60-5672	492	60-5837	304	60-5948	111	60-6292	72
60-5673	492	60-5838	304	60-5961	110	60-6293	72
60-5674	493	60-5839	304	60-5964	110	60-6294	72
60-5675	493	60-5841	100	60-5967	110	60-6295	73
60-5676	493	60-5842	101	60-5971	247	60-6301	203
60-5690	229	60-5843	100	60-5972	245	60-6302	203
60-5691	231	60-5844	101	60-5974	255	60-6303	203
60-5692	231	60-5847	305	60-5975	253	60-6304	203
60-5693	231	60-5848	305	60-5976	253	60-6305	201

INDEX

60-6307	201	60-6424	52	62-142	79	62-765	442
60-6308	202	60-6425	50	62-143	79	62-766	442
60-6309	200	60-6426	50	62-144	79	62-771	342
60-6311	201	60-6427	53	62-145	78	62-772	342
60-6312	200	60-6428	53	62-146	79	62-773	342
60-6313	202	60-6429	53	62-185	319	62-774	342
60-6321	211	60-6430	53	62-186	319	62-775	342
60-6322	211	60-6431	97	62-311	310	62-776	342
60-6323	211	60-6432	96	62-312	311	62-786	347
60-6324	211	60-6433	96	62-313	311	62-787	347
60-6325	209	60-6434	97	62-314	310	62-788	347
60-6326	209	60-6435	96	62-315	311	62-789	347
60-6327	208	60-6436	97	62-316	311	62-791	444
60-6328	210	60-6441	334	62-317	310	62-792	444
60-6329	208	60-6442	335	62-318	311	62-795R1	444
60-6331	209	60-6443	335	62-319	311	62-796R1	444
60-6341	219	60-6444	334	62-441	275	62-797	445
60-6342	219	60-6451	59	62-442	275	62-798	445
60-6343	219	60-6452	58	62-443	275	62-821	502
60-6344	219	60-6453	59	62-444	275	62-822	502
60-6345	217	60-6454	59	62-445	275	62-823	502
60-6346	217	60-6455	58	62-446	274	62-824	503
60-6347	218	60-6481	33	62-447	275	62-825	503
60-6348	218	60-6482	33	62-458	340	62-837	300
60-6349	216	60-6483	32	62-459	340	62-838	301
60-6351	216	60-6484	32	62-460	340	62-851	298
60-6352	217	60-6501	484	62-468	341	62-852	298
60-6353	218	60-6502	484	62-469	341	62-856	299
60-6361	85	60-6503	485	62-470	341	62-857	299
60-6362	85	60-6504	485	62-524	343	62-871	320
60-6363	85	60-6511	486	62-525	343	62-872	320
60-6369	221	60-6512	486	62-526	343	62-873	321
60-6371	223	60-6513	487	62-609	344	62-874	321
60-6372	223	60-6514	487	62-611	345	62-875	320
60-6373	223	60-6521	25	62-631	494	62-876	321
60-6374	223	60-6522	24	62-632	494	62-877	279
60-6375	221	60-6523	24	62-633	494	62-878	279
60-6376	222	60-6525	24	62-634	495	62-879	279
60-6377	222	60-6526	25	62-635	495	62-881	302
60-6378	221	60-6531	29	62-641	496	62-882	302
60-6379	220	60-6532	29	62-642	496	62-886	303
60-6381	40	60-6533	29	62-643	496	62-887	303
60-6382	40	60-6534	28	62-644	497	62-888	278
60-6383	41	60-6535	28	62-645	497	62-889	278
60-6385	41	60-6536	28	62-651	500	62-891	191
60-6387	40	60-6537	28	62-652	500	62-892	191
60-6391	270	60-6538	29	62-653	500	62-893	190
60-6392	270	60-6543	91	62-654	501	62-894	190
60-6393	270	60-6544	90	62-655	501	62-895	191
60-6395	271	60-6545	91	62-709	344	62-896	191
60-6396	271	60-6561	195	62-711	345	62-897	191
60-6397	271	60-6562	195	62-721	318	62-911	322
60-6401	482	60-6563	195	62-722	318	62-912	322
60-6402	482	60-6564	195	62-723	318	62-913	323
60-6403	482	60-6565	194	62-724	318	62-914	323
60-6405	483	60-6566	194	62-731	316	62-915	322
60-6406	483	62-102	309	62-732	316	62-916	323
60-6411	38	62-104	308	62-733	316	62-921	324
60-6412	38	62-105	292	62-734	316	62-922	324
60-6413	39	62-106	292	62-741	317	62-923	325
60-6414	38	62-116	293	62-742	317	62-924	325
60-6415	38	62-122	309	62-743	317	62-925	324
60-6416	39	62-124	308	62-744	317	62-926	325
60-6417	39	62-125	293	62-745	442	62-931	328
60-6421	51	62-126	293	62-746	442	62-932	328
60-6422	51	62-136	292	62-747	442	62-933	329
60-6423	51	62-141	78	62-748	442	62-934	329

62-935	328	62-1141	515	62-1294	457	62-1462	291
62-936	329	62-1142	515	62-1295	457	62-2932	297
62-951	283	62-1143	515	62-1301	471	62-2934	296
62-952	283	62-1144	515	62-1302	471	62-2936	296
62-953	283	62-1145	515	62-1303	471	63-101	559
62-954	282	62-1146	515	62-1304	471	63-102	559
62-955	282	62-1151	450	62-1305	471	63-103	559
62-971	350	62-1152	451	62-1306	471	63-104	559
62-972	350	62-1153	450	62-1307	471	63-201	559
62-975	350	62-1154	452	62-1308	471	63-202	559
62-976	350	62-1155	453	62-1321	314	63-203	559
62-977	350	62-1156	453	62-1322	314	63-204	559
62-978	350	62-1157	453	62-1323	314	63-301	561
62-981	350	62-1161	472	62-1324	315	63-302	561
62-982	350	62-1162	472	62-1325	315	63-303	561
62-985R1	348	62-1163	472	62-1326	315	63-304	561
62-986R1	348	62-1164	472	62-1327	312	63-305	561
62-987R1	348	62-1165	472	62-1328	312	63-306	561
62-988R1	349	62-1166	472	62-1329	312	63-307	561
62-989R1	349	62-1167	472	62-1330	313	63-309	561
62-990R1	349	62-1168	472	62-1331	313	63-311	561
62-991	446	62-1171	454	62-1332	313	63-314	561
62-992	272	62-1172	455	62-1351	287	63-315	561
62-993	272	62-1173	454	62-1352	286	65-113	514
62-994	272	62-1174	455	62-1353	287	65-114	514
62-995	273	62-1175	456	62-1371	454	65-401	517
62-996	273	62-1176	456	62-1372	455	65-402	517
62-997	273	62-1177	456	62-1373	454	65-403	516
62-1031	437	62-1181	454	62-1374	455	65-404	516
62-1032	437	62-1182	455	62-1375	456	65-405	517
62-1033	441	62-1183	454	62-1376	456	65-406	517
62-1034	441	62-1184	455	62-1377	456	65-407	516
62-1035	434	62-1185	456	62-1381	454	65-408	516
62-1036	434	62-1186	456	62-1382	455	65-409	517
62-1037	434	62-1187	456	62-1383	454	65-410	517
62-1038	434	62-1191	457	62-1384	455	65-411	516
62-1039	435	62-1192	457	62-1385	456	65-412	516
62-1040	435	62-1200	552	62-1386	456	65-1081	448
62-1041	434	62-1201	552	62-1387	456	65-1082	448
62-1042	346	62-1202	552	62-1401	306	65-1083	448
62-1043	346	62-1203	552	62-1402	306	65-1084	448
62-1044	346	62-1204	552	62-1403	307	65-1091	449
62-1045	436	62-1205	552	62-1404	306	65-1092	449
62-1046	440	62-1221	476	62-1405	307	65-1095	449
62-1051	450	62-1223	476	62-1406	307	65-1096	449
62-1052	451	62-1231	480	62-1431	441	65-1097	449
62-1053	450	62-1233	481	62-1432	441	65-1098	449
62-1054	452	62-1235	481	62-1435	438	65-1101	447
62-1055	453	62-1237	481	62-1436	438	65-1102	447
62-1056	453	62-1241	477	62-1437	438	65-1103	447
62-1057	453	62-1251	450	62-1438	438	65-1104	447
62-1081	332	62-1252	451	62-1439	439	65-1107	447
62-1082	332	62-1253	450	62-1440	439	65-1108	447
62-1083	332	62-1254	452	62-1441	438	76-024	373
62-1091	333	62-1255	453	62-1442	346	76-025	373
62-1092	333	62-1256	453	62-1443	346	76-026	373
62-1093	333	62-1257	453	62-1444	346	76-091	377
62-1095	443	62-1261	473	62-1445	440	76-092	377
62-1096	443	62-1262	473	62-1451	288	76-093	377
62-1097	443	62-1263	473	62-1452	289	76-124	375
62-1098	443	62-1264	473	62-1453	289	76-125	375
62-1101	330	62-1265	473	62-1454	288	76-126	375
62-1102	330	62-1266	473	62-1455	288	76-127	375
62-1103	330	62-1267	473	62-1456	289	76-128	375
62-1131	331	62-1268	473	62-1457	289	76-129	375
62-1132	331	62-1291	457	62-1458	288	76-130	379
62-1133	331	62-1292	457	62-1461	290	76-131	378

INDEX

76-132.	379	76-622.	545	77-088.	431	77-857.	543
76-133.	378	76-623.	545	77-097.	392	77-858.	542
76-134.	379	76-624.	544	77-098.	392	77-859.	543
76-135.	378	76-625.	544	77-099.	392	77-861.	542
76-191.	377	76-626.	544	77-100.	392	77-863.	546
76-192.	377	76-627.	544	77-101.	392	77-879.	546
76-193.	377	76-632.	553	77-102.	392	77-891.	546
76-243.	374	76-633.	553	77-108.	389	77-896.	549
76-244.	374	76-634.	553	77-109.	390	77-897.	549
76-245.	374	76-635.	553	77-110.	389	77-898.	549
76-246.	374	76-636.	553	77-111.	390	77-899.	549
76-247.	374	76-637.	553	77-119.	548	77-921.	384
76-248.	374	76-638.	554	77-120.	431	77-924.	384
76-250.	388	76-639.	554	77-121.	431	77-947.	389
76-251.	388	76-640.	554	77-122.	390	77-948.	390
76-252.	388	76-641.	554	77-123.	391	77-968.	555
76-253.	388	76-644.	554	77-125.	391	77-969.	555
76-256.	388	76-645.	552	77-126.	394	77-986.	382
76-257.	388	76-646.	552	77-136.	547	77-987.	382
76-268.	393	76-647.	552	77-137.	547	77-988.	384
76-269.	393	76-648.	552	77-138.	547	77-989.	430
76-270.	394	76-650.	555	77-139.	546	77-990.	430
76-273.	430	76-651.	555	77-140.	546	77-991.	431
76-276.	430	76-652.	555	77-141.	546	77-992.	548
76-277.	431	76-655.	552	77-152.	547	77-995.	548
76-280.	363	76-656.	552	77-153.	547	77-996.	548
76-283.	401	76-657.	552	77-154.	547	90-1278.	554
76-284.	401	76-658.	552	77-155.	547	90-1279.	554
76-412.	395	76-660.	401	77-156.	547	S8672.	467
76-416.	395	76-661.	401	77-157.	547	S8673.	467
76-418.	395	76-662.	401	77-188.	428	S8674.	467
76-422.	395	76-663.	401	77-189.	428	S8675.	467
76-444.	362	76-664.	554	77-190.	428	S9299.	351
76-445.	362	76-665.	554	77-191.	428	S9368.	469
76-446.	400	76-666.	554	77-192.	429	S9369.	469
76-447.	400	76-667.	554	77-193.	429	S9780.	351
76-500.	550	76-668.	554	77-194.	429	S9880.	468
76-501.	550	76-670.	386	77-195.	429	S9881.	468
76-502.	551	76-671.	386	77-196.	429	S9882.	470
76-503.	551	76-672.	385	77-323.	553	S9883.	470
76-520.	551	76-673.	386	77-324.	553	S9884.	470
76-521.	551	76-674.	386	77-342.	393	S9885.	470
76-522.	551	76-675.	385	77-343.	393	S9886.	470
76-523.	551	76-676.	386	77-344.	393	S9887.	470
76-530.	551	76-677.	386	77-345.	383	S9888.	470
76-531.	551	76-678.	385	77-346.	383	S9889.	470
76-600.	383	76-682.	551	77-347.	383	S21500.	458
76-601.	384	76-683.	551	77-392.	394	S21501.	458
76-602.	383	76-684.	551	77-487.	550	S21502.	458
76-603.	384	76-685.	551	77-488.	550	S21503.	459
76-604.	383	76-690.	400	77-494.	550	S21504.	459
76-605.	384	76-691.	400	77-495.	550	S21505.	459
76-606.	376	76-693.	362	77-530.	547	S21506.	459
76-607.	376	76-694.	362	77-531.	546	S21507.	460
76-608.	376	76-695.	362	77-532.	547	S21508.	460
76-609.	376	76-700.	548	77-533.	547	S21509.	461
76-610.	376	76-701.	548	77-692.	555	S21510.	461
76-611.	376	76-702.	548	77-693.	555	S21511.	461
76-612.	385	76-703.	548	77-700.	550	S21512.	462
76-613.	385	76-704.	548	77-701.	550	S21513.	462
76-614.	385	76-705.	548	77-702.	550	S21514.	462
76-615.	545	77-059.	382	77-703.	550	S21515.	463
76-616.	544	77-060.	382	77-823.	393	S21516.	463
76-617.	545	77-061.	382	77-824.	394	S21517.	463
76-618.	544	77-062.	382	77-835.	546	S29320.	458
76-620.	545	77-086.	430	77-852.	549	S29321.	458
76-621.	545	77-087.	430	77-853.	549	S29322.	458

S29323	458	TH224	576	TH433	565	TP147	578
S29324	459	TH225	576	TH434	565	TP148	578
S29325	459	TH226	576	TH435	565	TP149	578
S29326	459	TH227	576	TH437	565	TP150	578
S29327	459	TH232	577	TH441	566	TP151	578
S29328	460	TH233	577	TH442	566	TP152	578
S29329	460	TH234	577	TH443	566	TP153	578
S29330	460	TH235	577	TH444	566	TP154	578
S29331	460	TH238	577	TH445	566	TP155	578
S29332	461	TH239	577	TH447	566	TP156	578
S29333	461	TH279	576	TH451	567	TP157	578
S29334	461	TH280	576	TH452	567	TP159	579
S29335	461	TH283	576	TH453	567	TP160	579
S29336	462	TH284	576	TH454	567	TP161	579
S29337	462	TH300	575	TH455	567	TP162	579
S29338	462	TH301	575	TH457	567	TP163	579
S29339	462	TH302	576	TH461	568	TP164	579
S29340	463	TH303	574	TH462	568	TP165	579
S29341	463	TH304	574	TH463	568	TP166	579
S29342	463	TH305	574	TH464	568	TP167	578
S29343	463	TH306	575	TH465	568	TP168	578
S29344	465	TH307	574	TH467	568	TP169	578
S29345	465	TH308	574	TH471	569	TP170	578
S29346	465	TH312	577	TH472	569	TP171	578
S29347	465	TH313	577	TH473	569	TP172	578
S29349	460	TH314	577	TH474	569	TP176	579
S29357	460	TH315	577	TH475	569	TP177	579
S29358	462	TH316	577	TH477	569	TP178	579
S29359	458	TH317	577	TK310	573	TP179	579
S29360	460	TH321	577	TK315	573	TP180	579
S29361	461	TH322	577	TK316	572	TP181	579
S29362	462	TH323	577	TK317	572	TP201	578
S29363	463	TH324	576	TK318	572	TP202	578
S29367	460	TH331	576	TK319	572	TP203	578
S29379	462	TH332	576	TK320	572	TP204	578
S29650	464	TH333	576	TK321	572	TP205	578
S29651	464	TH341	574	TK322	572	TP206	578
S29652	464	TH342	574	TK323	572	TP207	578
S29653	465	TH343	574	TK340	572	TP208	578
S29654	465	TH344	574	TK341	572	TP209	578
S29655	460	TH345	574	TK342	572	TP211	578
S29656	466	TH346	575	TK343	572	TP231	578
S29657	466	TH347	575	TK345	573	TP232	578
S29658	466	TH348	575	TK346	573	TP233	578
S29659	466	TH349	576	TK347	573	TR118	579
S29690	462	TH351	577	TK348	573	TR119	579
S29691	464	TH352	577	TK349	573	TR120	579
TH200	574	TH401	562	TK352	573	TR121	579
TH201	574	TH402	562	TK353	573	TR122	579
TH202	574	TH403	562	TK354	573	TR123	579
TH203	574	TH404	562	TK355	573	TR124	579
TH204	574	TH405	562	TK361	572	TR125	579
TH205	574	TH407	562	TK362	572	TR126	579
TH206	574	TH411	563	TK403	570	TR127	579
TH207	574	TH412	563	TK404	570	TR128	579
TH208	574	TH413	563	TK407	570	TR129	579
TH209	574	TH414	563	TK413	571	TR131	579
TH210	575	TH415	563	TK414	571	TR132	579
TH211	575	TH417	563	TK417	571	TR133	579
TH216	575	TH421	564	TK423	571	TR134	579
TH217	575	TH422	564	TK424	571		
TH218	575	TH423	564	TK427	571		
TH219	575	TH424	564	TP142	579		
TH220	575	TH425	564	TP143	579		
TH221	575	TH427	564	TP144	578		
TH222	575	TH431	565	TP145	578		
TH223	575	TH432	565	TP146	578		



www.nuvolighting.com
Catalog NU4050



National Toll-Free: **1.800.43.SATCO** (1.800.437.2826) www.satco.com

Corporate Offices & Distribution Center: **NEW YORK** 110 Heartland Blvd., Brentwood, NY 11717 800.437.2826 631.243.2022 Fax 631.243.2027

Distribution Centers: **FLORIDA** 900 N.W. 159th Drive, Miami, FL 33169 800.437.2826 305.624.2044 FAX 305.623.0286
CALIFORNIA 31288 San Benito St. Hayward, CA 94544 800.437.2826 510.487.4822 FAX 510.487.8955
WASHINGTON 4710 116th St. S.W., Mukilteo, WA 98275 800.437.2826 425.789.3300 FAX 425.789.3310
TEXAS 2000 Valwood Parkway, Farmers Branch, TX 75234 800.437.2826 972.247.2437 FAX 972.247.5408
PUERTO RICO Campeche St. 23, Julio N. Matos Industrial Park, Carolina, PR 00984 787.757.3510 FAX 787.757.3540



Like us!



Follow us!

© Copyright 2019, SATCO Products, Inc