



LITE SOURCE INC.



2018 *Portable & Fixture Collections*

MEMBER
american
lighting
association

#181







CONTEMPORARY • Page 1-79

Lite Source offers a vast array of clean-lined contemporary designs that fit beautifully with today's modern lifestyle. Our close attention to detail, finishing & Shade treatment ensured that each piece will be a fashion forward fit for your home.

TRANSITIONAL • Page 80-129

Lamp designs that incorporate simplistic lines and a modern flair fit our definition of transitional styling. This category encompassed the widest range of designs and finishes. You're sure to find styles that are a fit with today's simplified, clean line, décor trends.



LED • Page 130-161

Lamps unitizing LED technology represent the fastest growing, ever evolving, product category. With nearly one hundred styles to choose from Lite Source proudly combines modern styling with superior lumen output to deliver quality products for both the home and workplace.

RUSTIC & INDUSTRIAL • Page 162-191

Whether you need an iron lamp that's at home in Manhattan or the mountains you will find it here. We offer a wide array of pleasing styles in metal, wood and ceramic designed in rustic and industrial themes.



DESK & TASK • Page 192-217

Lite Source is the leader in task and desk lamp selection and styling. Form and function cover a wide range of design needs from college dorms to executive boardrooms. Quality task lighting has never been more in demand and we offer innovative styling solution for both the home and workplace.

TRADITIONAL • Page 218-241

Our traditional lighting continues to have its roots in classic design and finishing. Special attention to multi-toned finishing and style right shades continues to be the hallmark of this category. Tiffany lamps represent the ultimate in style and craftsmanship as each lamp is hand made by skilled artisans.



FIXTURE COLLECTIONS • Page 242-299

Our fixture collections include an eclectic range of styles such as contemporary, traditional, transitional, industrial, rustic and everything else in between. Each style is accentuated by the most suitable light source such as LED, incandescent, halogen, or vintage bulb, in order to create that perfect illumination and mood within your space. With our large selection of items, we are confident that you will find the perfect piece for your home, office, or business.

Contemporary Collections



Page 1 **NEW!**



Page 1 **NEW!**



Page 3



Page 3 **NEW!**



Page 3 **NEW!**



Page 4 **NEW!**



Page 4 **NEW!**



Page 4 **NEW!**



Page 6 **NEW!**



Page 6 **NEW!**



Page 7 **NEW!**



Page 7 **NEW!**



Page 7 **NEW!**



Page 9 **NEW!**



Page 9 **NEW!**



Page 9 **NEW!**



Page 9 **NEW!**



Page 10 **NEW!**



Page 10 **NEW!**



Page 11 **NEW!**



Page 11 **NEW!**



Page 11 **NEW!**



Page 12



Page 12



Page 12



Page 13



Page 13



Page 13



Page 14



Page 14



Page 14



Page 15 **NEW!**



Page 15 **NEW!**



Page 15

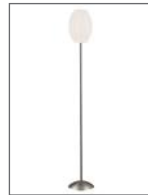

Page 15



Page 17



Page 17



Page 17 **NEW!**



Page 18 **NEW!**



Page 18 **NEW!**



Page 18 **NEW!**



Page 19 **NEW!**



Page 19 **NEW!**



Page 19 **NEW!**

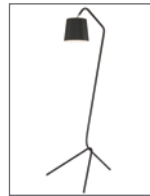

Page 19 **NEW!**



Page 19 **NEW!**



Page 19 **NEW!**



Page 20 **NEW!**



Page 20 **NEW!**



Page 21 **NEW!**



Page 21 **NEW!**



Page 22 **NEW!**



Page 22 **NEW!**



Page 23 **NEW!**



Page 23



Page 23



Page 25 **NEW!**



Page 25 **NEW!**



Page 25 **NEW!**



Page 26



Page 26



Page 26



Page 27



Page 27



Page 27



Page 28



Page 28



Page 29



Page 29



Page 30



Page 30



Page 30

Contemporary Collections



Page 30



Page 31



Page 31

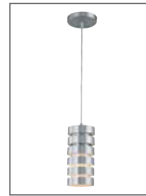

Page 33



Page 33



Page 33



Page 33

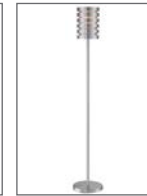

Page 33



Page 34



Page 34



Page 34



Page 35



Page 35



Page 35



Page 35



Page 36



Page 36

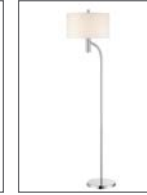

Page 36



Page 37



Page 37



Page 37



Page 38



Page 38

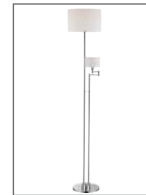

Page 38



Page 39



Page 39



Page 40



Page 40



Page 41 **NEW!**



Page 41 **NEW!**



Page 43



Page 43



Page 43



Page 44



Page 44



Page 45 **NEW!**



Page 45 **NEW!**



Page 45



Page 47 **NEW!**



Page 47 **NEW!**



Page 47 **NEW!**



Page 47 **NEW!**



Page 48 **NEW!**



Page 48 **NEW!**



Page 48 **NEW!**



Page 48 **NEW!**



Page 49 **NEW!**



Page 49



Page 49 **NEW!**



Page 49 **NEW!**



Page 50 **NEW!**



Page 50 **NEW!**



Page 50 **NEW!**



Page 51 **NEW!**



Page 51 **NEW!**



Page 51 **NEW!**



Page 52 **NEW!**



Page 52 **NEW!**



Page 52 **NEW!**



Page 53 **NEW!**



Page 53 **NEW!**



Page 53 **NEW!**



Page 53 **NEW!**



Page 54 **NEW!**



Page 54 **NEW!**



Page 54 **NEW!**



Page 54 **NEW!**



Page 54 **NEW!**



Page 54 **NEW!**



Page 54 **NEW!**



Page 54 **NEW!**



Page 54 **NEW!**

Contemporary Collections



Page 55 **NEW!**



Page 55 **NEW!**



Page 55 **NEW!**



Page 55 **NEW!**



Page 55 **NEW!**



Page 55 **NEW!**



Page 55 **NEW!**



Page 55 **NEW!**



Page 56



Page 56



Page 56



Page 56



Page 56



Page 57



Page 57



Page 57



Page 57



Page 57



Page 57



Page 57



Page 57



Page 57



Page 57



Page 57



Page 57



Page 58 **NEW!**



Page 58 **NEW!**



Page 58 **NEW!**



Page 58 **NEW!**



Page 59 **NEW!**



Page 59 **NEW!**



Page 59 **NEW!**



Page 59 **NEW!**



Page 61



Page 61



Page 61



Page 61



Page 61



Page 62



Page 62



Page 62



Page 62



Page 62



Page 62



Page 63



Page 63



Page 63



Page 63



Page 63



Page 64



Page 64



Page 64



Page 64



Page 64



Page 64



Page 65



Page 65



Page 65



Page 65



Page 65



Page 67



Page 67



Page 67



Page 67



Page 67



Page 68



Page 68



Page 68



Page 68



Page 68



Page 68



Page 69

Contemporary Collections



Page 69



Page 69 **NEW!**



Page 69 **NEW!**



Page 69 **NEW!**



Page 70



Page 70



Page 70



Page 70



Page 70



Page 70



Page 71



Page 71



Page 71



Page 71



Page 71



Page 71



Page 72



Page 72



Page 72



Page 72



Page 72



Page 72



Page 73



Page 73



Page 73



Page 73



Page 73



Page 73



Page 73



Page 73



Page 74



Page 74



Page 74



Page 74



Page 74

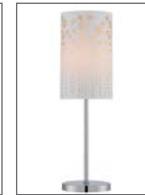

Page 74



Page 74



Page 75



Page 75



Page 75



Page 75

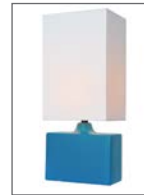

Page 75



Page 75



Page 76



Page 76



Page 76



Page 76



Page 76



Page 76

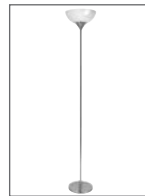

Page 77



Page 77



Page 77

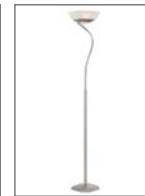

Page 77

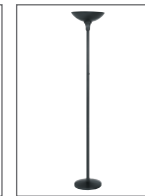

Page 78



Page 78



Page 78

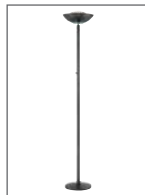

Page 78



Page 78



Page 79



Page 79



Page 79

Transitional Collections



Page 81 **NEW!**



Page 81 **NEW!**



Page 81 **NEW!**



Page 83 **NEW!**



Page 83 **NEW!**



Page 83 **NEW!**



Page 84 **NEW!**



Page 84 **NEW!**



Page 85 **NEW!**



Page 85 **NEW!**



Page 86 **NEW!**



Page 86 **NEW!**



Page 87 **NEW!**



Page 87 **NEW!**



Page 89 **NEW!**



Page 89 **NEW!**



Page 90 **NEW!**



Page 90 **NEW!**



Page 91 **NEW!**



Page 91 **NEW!**



Page 92 **NEW!**



Page 92 **NEW!**



Page 93 **NEW!**



Page 93 **NEW!**



Page 94 **NEW!**



Page 94 **NEW!**



Page 94 **NEW!**



Page 94 **NEW!**



Page 96 **NEW!**



Page 96 **NEW!**



Page 97 **NEW!**



Page 97 **NEW!**



Page 98



Page 98



Page 98



Page 99 **NEW!**

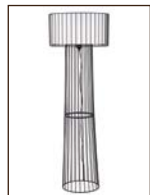

Page 99 **NEW!**



Page 100



Page 100



Page 101 **NEW!**



Page 101 **NEW!**



Page 102



Page 102



Page 103 **NEW!**



Page 103 **NEW!**



Page 105



Page 105



Page 105 **NEW!**



Page 106



Page 106



Page 106



Page 107



Page 107



Page 108



Page 108



Page 108



Page 109

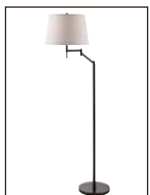

Page 109



Page 109



Page 111 **NEW!**



Page 111 **NEW!**



Page 111 **NEW!**



Page 111 **NEW!**



Page 112 **NEW!**



Page 112 **NEW!**



Page 112 **NEW!**



Page 112 **NEW!**



Page 112 **NEW!**



Page 113 **NEW!**



Page 113 **NEW!**



Page 113 **NEW!**



Page 113 **NEW!**

Transitional Collections



LED Collections



LED Collections



Page 137 **NEW!**



Page 137 **NEW!**



Page 138



Page 138



Page 138

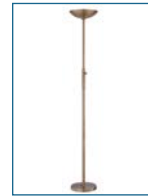

Page 139

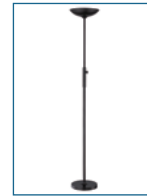

Page 139

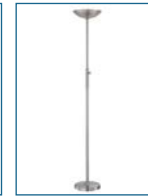

Page 139



Page 141 **NEW!**



Page 141 **NEW!**

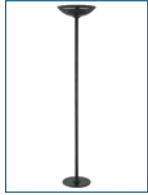

Page 142 **NEW!**



Page 142 **NEW!**



Page 143 **NEW!**



Page 143 **NEW!**



Page 145



Page 145

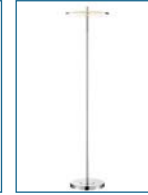

Page 145



Page 145



Page 146 **NEW!**



Page 146 **NEW!**



Page 146 **NEW!**



Page 147 **NEW!**



Page 147 **NEW!**



Page 147 **NEW!**



Page 148



Page 148

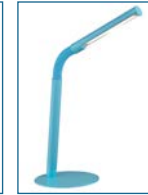

Page 148



Page 148



Page 148



Page 149



Page 149



Page 149



Page 149



Page 150



Page 150



Page 150



Page 150



Page 151



Page 151



Page 151 **NEW!**



Page 151 **NEW!**



Page 152



Page 152



Page 152



Page 152



Page 154



Page 154



Page 154



Page 154



Page 155



Page 155



Page 155



Page 156



Page 156



Page 156



Page 156



Page 157



Page 157



Page 157



Page 157



Page 159



Page 159 **NEW!**

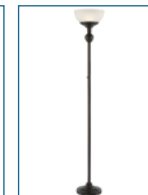

Page 159 **NEW!**



Page 160

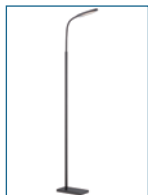

Page 160



Page 160



Page 161



Page 161



Page 161 **NEW!**

Rustic & Industrial Collections



Page 163



Page 163



Page 163



Page 164



Page 164



Page 164



Page 165



Page 165



Page 165



Page 165



Page 166 **NEW!**



Page 166 **NEW!**



Page 167 **NEW!**



Page 167 **NEW!**



Page 167 **NEW!**



Page 168 **NEW!**

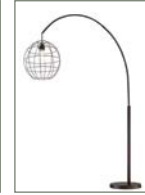

Page 168 **NEW!**



Page 169 **NEW!**



Page 169 **NEW!**



Page 170



Page 170



Page 171 **NEW!**



Page 171 **NEW!**



Page 173



Page 173



Page 173



Page 174 **NEW!**



Page 174 **NEW!**



Page 175



Page 175



Page 176



Page 176



Page 177



Page 177



Page 178

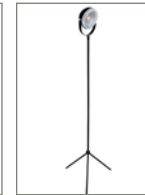

Page 178



Page 179



Page 179



Page 180



Page 180



Page 182



Page 182



Page 183



Page 183



Page 183



Page 184



Page 184



Page 184

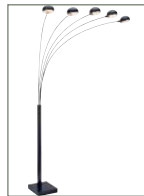

Page 185



Page 185



Page 185



Page 187 **NEW!**



Page 187 **NEW!**



Page 188



Page 188



Page 188 **NEW!**

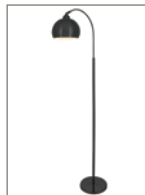

Page 189



Page 189



Page 189 **NEW!**



Page 190



Page 190

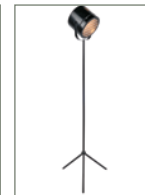

Page 190



Page 191



Page 191



Page 191



Page 191



Page 191

Desk & Task Collections



Page 193 **NEW!**



Page 193 **NEW!**



Page 194 **NEW!**



Page 194



Page 194 **NEW!**



Page 195 **NEW!**



Page 195 **NEW!**



Page 195 **NEW!**

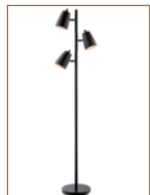

Page 196 **NEW!**



Page 196 **NEW!**



Page 196 **NEW!**



Page 197 **NEW!**



Page 197 **NEW!**



Page 197 **NEW!**



Page 199 **NEW!**



Page 199 **NEW!**



Page 199 **NEW!**



Page 200



Page 200



Page 200

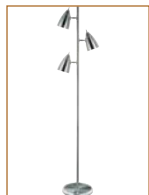

Page 200



Page 201



Page 201



Page 201



Page 202

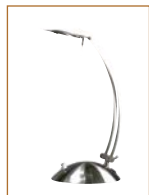

Page 202



Page 202

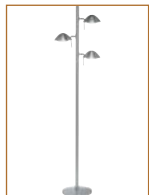

Page 202



Page 203



Page 203



Page 203



Page 203



Page 204



Page 204



Page 204



Page 204



Page 205



Page 205



Page 205



Page 205



Page 205



Page 206



Page 206



Page 206



Page 208



Page 208



Page 208



Page 208



Page 208



Page 208



Page 208



Page 208



Page 208



Page 208



Page 209



Page 209



Page 209



Page 209



Page 209



Page 209



Page 210



Page 210



Page 210



Page 210



Page 210



Page 211



Page 211



Page 211



Page 211



Page 211



Page 211



Page 212

Desk & Task Collections



Traditional Collections



Traditional Collections



Page 233



Page 233



Page 233



Page 234



Page 234



Page 234



Page 235



Page 235



Page 235



Page 237



Page 237



Page 237



Page 238



Page 238



Page 238



Page 238



Page 239



Page 239



Page 239



Page 239



Page 240



Page 240



Page 240



Page 241



Page 241

Fixture Collections



Page 243 **NEW!**



Page 243 **NEW!**



Page 243 **NEW!**



Page 243 **NEW!**



Page 244 **NEW!**



Page 244 **NEW!**



Page 244 **NEW!**



Page 244 **NEW!**



Page 245 **NEW!**



Page 245 **NEW!**



Page 246



Page 246



Page 246



Page 247 **NEW!**



Page 247 **NEW!**



Page 247 **NEW!**



Page 249 **NEW!**



Page 249 **NEW!**



Page 249 **NEW!**



Page 250



Page 250



Page 250



Page 251



Page 251



Page 251

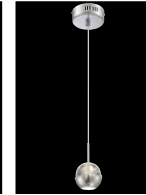

Page 252



Page 252



Page 252



Page 253



Page 253



Page 254

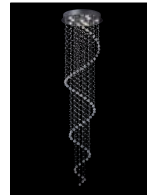

Page 254



Page 255



Page 255



Page 255



Page 256 **NEW!**

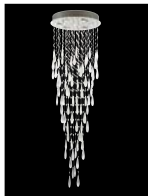

Page 256 **NEW!**



Page 258



Page 258



Page 258



Page 258



Page 259



Page 259

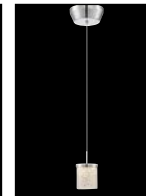

Page 259

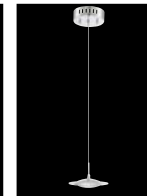

Page 260

Fixture Collections

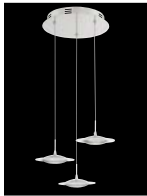

Page 260

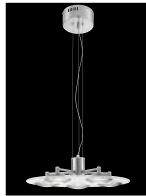

Page 260



Page 260

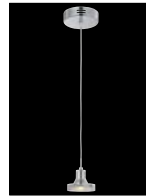

Page 260



Page 261

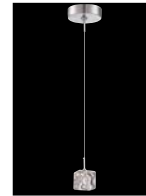

Page 261



Page 261

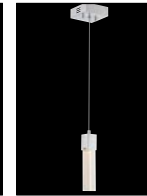

Page 261



Page 263 **NEW!**



Page 263 **NEW!**



Page 263 **NEW!**



Page 263 **NEW!**



Page 264



Page 264



Page 264



Page 265



Page 265



Page 266

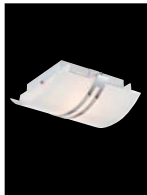

Page 266

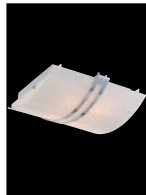

Page 266



Page 266



Page 267



Page 267



Page 267 **NEW!**

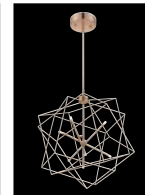

Page 268

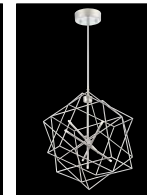

Page 268 **NEW!**

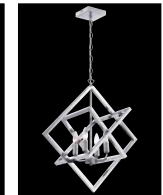

Page 268



Page 269 **NEW!**



Page 269 **NEW!**



Page 271 **NEW!**



Page 271 **NEW!**



Page 272



Page 272



Page 272



Page 272

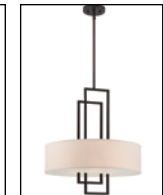

Page 272



Page 274



Page 274



Page 274



Page 275



Page 275 **NEW!**

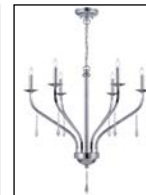

Page 275



Page 276



Page 276



Page 276



Page 276



Page 277



Page 277 **NEW!**



Page 277 **NEW!**



Page 278



Page 278



Page 278



Page 279



Page 279



Page 279

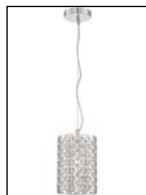

Page 280



Page 280



Page 280



Page 280



Page 281

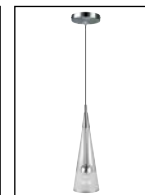

Page 281



Page 281



Page 281



Page 283



Page 283



Page 283



Page 283



Page 283



Page 284



Page 284



Page 284



Page 284

Fixture Collections



Page 285



Page 285



Page 285

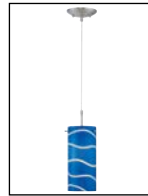

Page 285



Page 285

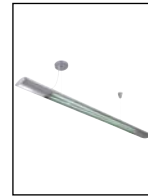

Page 286



Page 286



Page 287

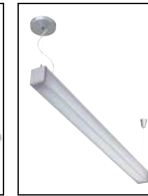

Page 287



Page 289 **NEW!**



Page 289 **NEW!**



Page 289 **NEW!**



Page 290



Page 290



Page 290



Page 290



Page 290

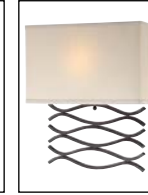

Page 290



Page 291



Page 291



Page 291



Page 291



Page 291



Page 291



Page 292



Page 292



Page 292



Page 292



Page 293



Page 293



Page 293



Page 293



Page 293



Page 294



Page 294



Page 294



Page 294



Page 294



Page 295



Page 295



Page 295

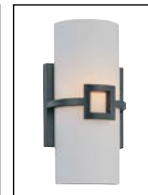

Page 295



Page 295



Page 296



Page 296



Page 296



Page 296



Page 296



Page 297



Page 297



Page 297



Page 297



Page 297



Page 297



Page 298



Page 298



Page 298



Page 298



Page 298



Page 298



Page 298



Page 299



Page 299



Page 299



Page 299



Page 299



Page 299



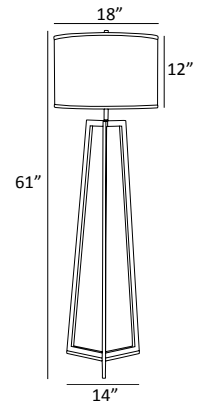
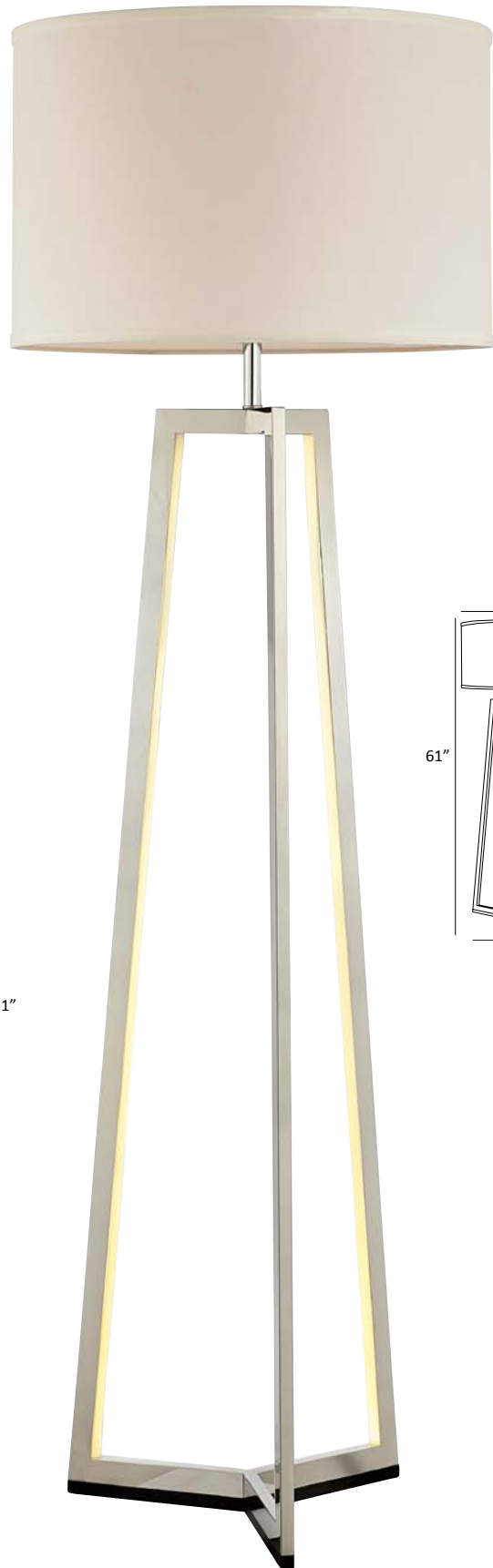
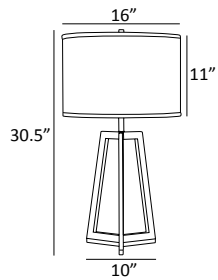

LS-23165 · Pax Table Lamp

Body: Chrome / Metal
Shade: White / Fabric
Switch: 3-Way Socket
Main Lamp: E-27 Medium Base (Max. 150W)
Nightlight: 6.3W LED Panel (3000K, 500lm, CRI: 80)
Features: **LED Nightlight**

LS-83165 · Pax Floor Lamp

Body: Chrome / Metal
Shade: White / Fabric
Switch: 3-Way Socket
Main Lamp: E-27 Medium Base (Max. 150W)
Nightlight: 20W LED Panel (3000K, 1500lm, CRI: 80)
Features: **LED Nightlight**



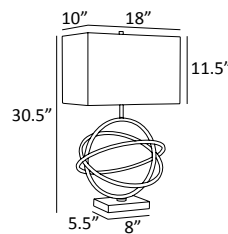
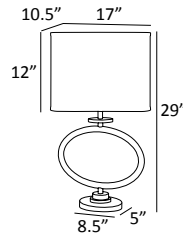
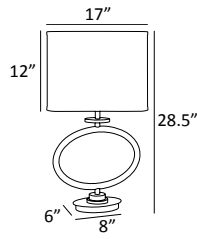

LS-22072 ① · Renia Table Lamp

Body: Chrome / Metal
Shade: Off-White / Fabric
Switch: 3-Way Socket
Lamp: E-27 Medium Base (Max. 150W)
Features: **Acrylic Accents**

LS-23074 ② · Renia II Table Lamp

Body: Chrome / Metal
Shade: Off-White / Fabric
Switch: 3-Way Socket
Main Lamp: E-27 Medium Base (Max. 100W)
Nightlight: 6W LED Panel (3000K, 480LM, CRI: 80)
Features: **LED Nightlight, Acrylic Accents**

LS-23167 ③ · Orville Table Lamp

Body: Brushed Nickel / Metal
Shade: Off-White / Fabric
Switch: 3-Way Socket
Main Lamp: E-27 Medium Base (Max. 100W)
Nightlight: 6.5W LED Panel (3000K, 500LM, CRI: 80)
Features: **LED Nightlight**

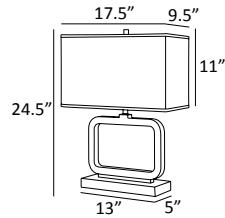

①

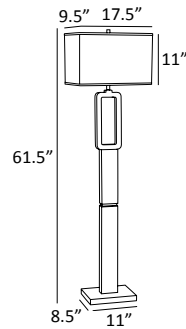

Scan For Video Presentation



②

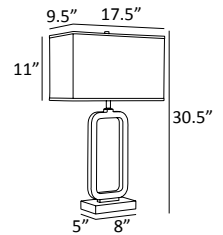

LS-83022 · Leonard Floor Lamp

Body: Walnut & Brushed Nickel / Metal
 Shade: Linen / Fabric
 Switch: 3-Way Socket
 Main Lamp: E-27 Medium Base (Max. 100W)
 Nightlight: 5.2W LED Panel (3000K, 410lm, CRI: 70)
 Features: **LED Nightlight, 3-Way Switch**

LS-23021 ① Leonard Table Lamp

LS-23022 ② Leonard Table Lamp

Body: Walnut Finish / Brushed Nickel Metal
 Shade: Linen / Fabric
 Switch: 3-Way Socket
 Main Lamp: E-27 Medium Base (Max. 100W)
 Nightlight: 6W LED Panel (3000K, 480LM, CRI: 80)
 Features: **LED Nightlight, 3-Way Switch**





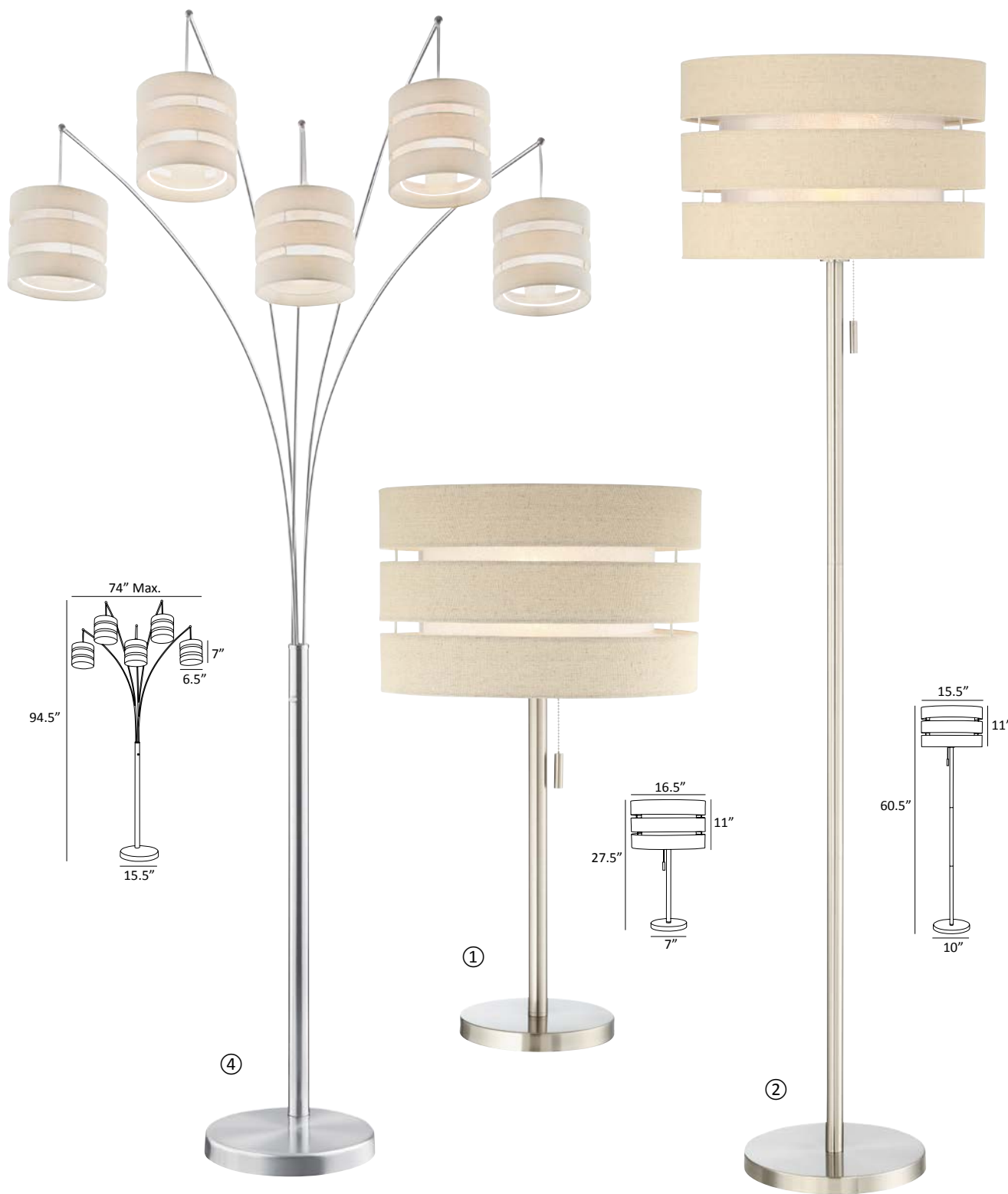

LS-23037 ① · Falan Table Lamp

Body: Brushed Nickel / Metal
 Shade: Linen / Fabric / Organza
 Switch: On/Off Pull-Chain
 Lamp: E-27 Medium Base (Max. 100W)
 Features: **Double-Layer Shade, Pull-Chain Switch**

LS-83037 ② · Falan Floor Lamp

Body: Brushed Nickel / Metal
 Shade: Linen / Fabric / Organza
 Switch: On/Off Pull-Chain
 Lamp: E-27 Medium Base (Max. 100W)
 Features: **Double-Layer Shade, Pull-Chain Switch**

LS-83038 ③ · Falan 3-Lite Arc Lamp

Body: Brushed Nickel / Metal
 Shade: Linen / Fabric / Organza
 Switch: 3-Way Rotary on Pole
 Lamp: E-27 Medium Base (Max. 60W) x3
 Features: **Double-Layer Shades, 3-Light, 3-Way Switch**

LS-83039 ④ · Falan 5-Lite Arc Lamp

Body: Brushed Nickel / Metal
 Shade: Linen / Fabric / Organza
 Switch: 3-Way Rotary on Pole
 Lamp: E-27 Medium Base (Max. 60W) x5
 Features: **Double-Layer Shades, 5-Light, 3-Way Switch**

LS-83040 ⑤ · Falan 3-Lite Floor Lamp

Body: Brushed Nickel / Metal
 Shade: Linen / Fabric / Organza
 Switch: 3-Way Rotary on Pole
 Lamp: E-27 Medium Base (Max. 60W) x3
 Features: **Double-Layer Shades, 3-Light, Adjustable Shades, 3-Way Switch**



*Scan For Video
Presentation*



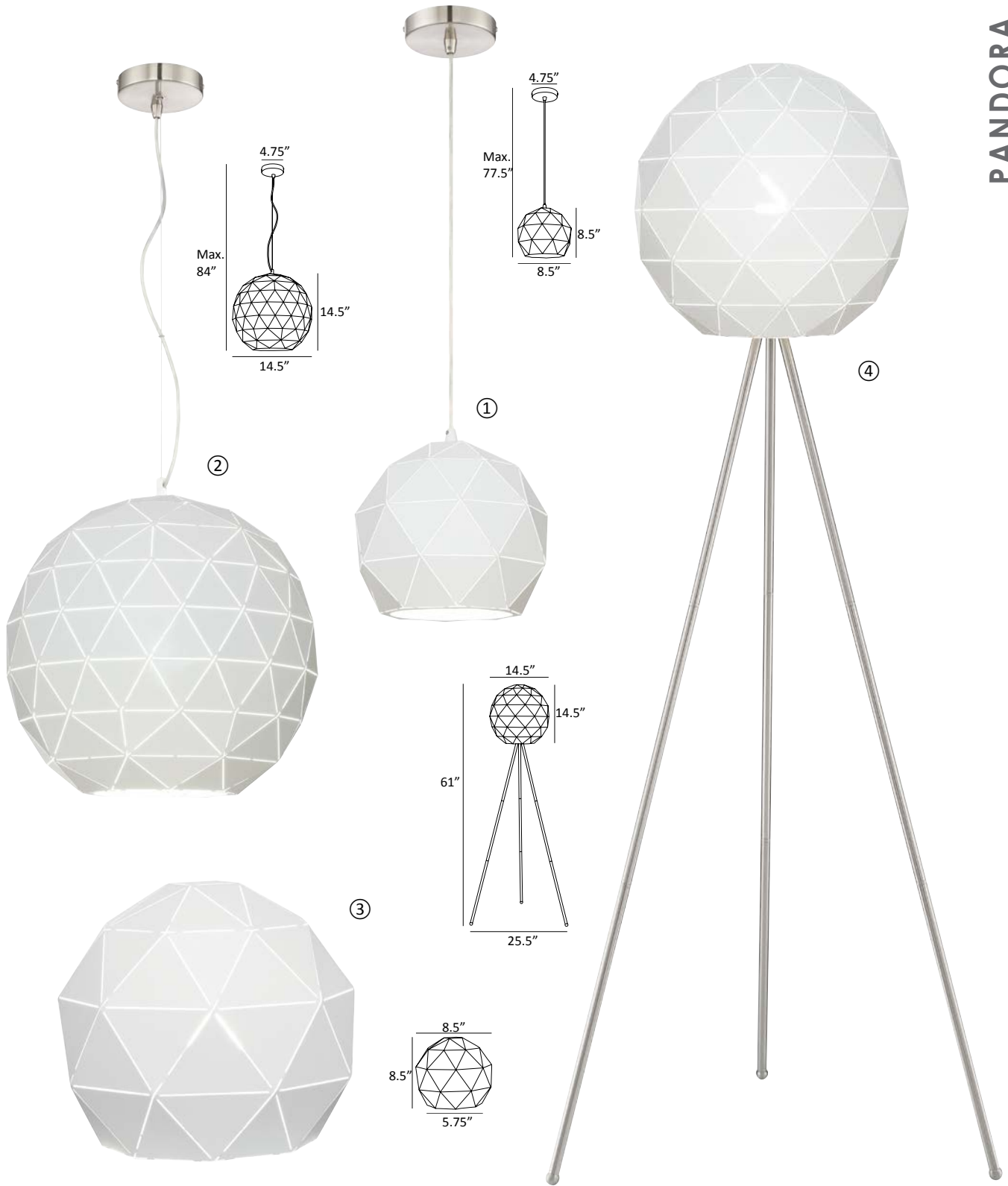

LS-19130 ① · Pandora Mini-Pendant

Canopy: Brushed Nickel / Metal
 Shade: White / Metal
 Lamp: E-27 Medium Base (Max. 60W)
 Features: **Laser-Cut Metal Shade, Adjustable Height**

LS-19132 ② · Pandora Pendant

Canopy: Brushed Nickel / Metal
 Shade: White / Metal
 Lamp: E-27 Medium Base (Max. 100W)
 Features: **Laser-Cut Metal Shade, Adjustable Height**

LS-23130 ③ · Pandora Table Lamp

Body: Brushed Nickel / Metal
 Shade: White / Metal
 Switch: On/Off In-Line
 Lamp: E-27 Medium Base (Max. 40W)
 Features: **Laser-Cut Metal Shade**

LS-83130 ④ · Pandora Floor Lamp

Body: Brushed Nickel / Metal
 Shade: White / Metal
 Switch: On/Off Foot
 Lamp: E-27 Medium Base (Max. 100W)
 Features: **Laser-Cut Metal Shade, Tripod Base**



Scan For Video Presentation

LS-83131 ① · Pandora Arc Floor Lamp

Body: Brushed Nickel / Metal
 Shade: White / Metal
 Switch: On/Off Rotary on Pole
 Lamp: E-27 Medium Base (Max. 100W)
 Features: **Laser-Cut Metal Shade**

LS-83132 ② · Pandora 3-Lite Arc Floor Lamp

Body: Brushed Nickel / Metal
 Shade: White / Metal
 Switch: 3-Way Rotary on Pole
 Lamp: E-27 Medium Base (Max. 60W) x3
 Features: **Laser-Cut Metal Shade, 3-Way Switch**

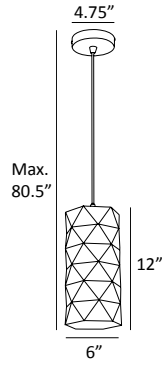

①



Scan For Video Presentation



②

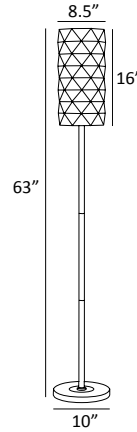
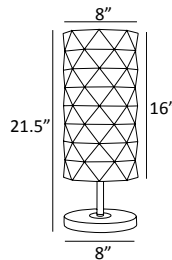

③

LS-19133 ① · Pandora Pendant

Canopy: Brushed Nickel / Metal
 Shade: White / Metal
 Lamp: E-27 Medium Base (Max. 60W)
 Features: **Laser-Cut Metal Shade, Adjustable Height**

LS-23133 ② · Pandora Table Lamp

Body: Brushed Nickel / Metal
 Shade: White / Metal
 Switch: On/Off In-Line
 Lamp: E-27 Medium Base (Max. 60W)
 Features: **Laser-Cut Metal Shade**

LS-83133 ③ · Pandora Floor Lamp

Body: Brushed Nickel / Metal
 Shade: White / Metal
 Switch: On/Off Foot
 Lamp: E-27 Medium Base (Max. 100W)
 Features: **Laser-Cut Metal Shade**



LS-18870PS/WHT ① · Deion Pendant

Body: Polished Steel / Metal
 Shade: White Pleated / Vinyl
 Lamp: E-27 Medium Base (Max. 60W)
 Features: **Double-Layer Shade**

LS-82957 ② · Deion Semi-Arc Lamp

Body: Polished Steel / Metal
 Shade: White Pleated / Vinyl
 Switch: On/Off Foot
 Lamp: E-27 Medium Base (Max. 150W)
 Features: **Double-Layer Shade**

LS-8872PS/WHT ③ · Deion 5-Lite Arc Lamp

Body: Polished Steel / Metal
 Shade: White Pleated / Vinyl
 Switch: 3-Way Rotary on Pole
 Lamp: E-27 Medium Base (Max. 60W) x5
 Features: **Double-Layer Shade, 3-Way Switch**



LS-8870PS/WHT ①

· Deion Arc Lamp

Body: Polished Steel / Metal
 Shade: White Pleated / Vinyl
 Switch: On/Off Rotary on Pole
 Lamp: E-27 Medium Base (Max. 100W)
 Features: **Double-Layer Shade**

LS-8871PS/WHT ②

· Deion 3-Lite Arc Lamp

Body: Polished Steel / Metal
 Shade: White Pleated / Vinyl
 Switch: 3-Way Rotary on Pole
 Lamp: E-27 Medium Base (Max. 60W) x3
 Features: **Double-Layer Shade, 3-Way Switch**

LS-8871PS/GREY ③

· Deion 3-Lite Arc Lamp

Body: Polished Steel / Metal
 Shade: Grey Pleated / Vinyl
 Switch: 3-Way Rotary on Pole
 Lamp: E-27 Medium Base (Max. 60W) x3
 Features: **Double-Layer Shade, 3-Way Switch**



①



②



③

LS-83163 ① · Lotuz 3-Lite Arc Lamp

Body: Chrome / Metal
 Shade: Clear Acrylic / Frosted Glass
 Switch: 3-Way Rotary on Pole
 Lamp: E-27 Medium Base (Max. 60W) x3
 Features: **Double-Layer Shade, 3-Way Switch**

LS-22160 ② · Lotuz Table Lamp

Body: Chrome / Metal
 Shade: Clear Acrylic / Frosted Glass
 Switch: On/Off In-Line
 Lamp: E-27 Medium Base (Max. 60W)
 Features: **Double-Layer Shade**

LS-19160 ③ · Lotuz Pendant

Body: Chrome / Metal
 Shade: Clear Acrylic / Frosted Glass
 Lamp: E-27 Medium Base (Max. 60W)
 Features: **Double-Layer Shade**



LS-8875SS/GREY ①
 LS-8875SS/WHT ② · Egg Floor Lamp
 Body: Satin Steel / Metal
 Shade: Grey or White Pleated / Vinyl
 Switch: On/Off Foot
 Lamp: E-27 Medium Base (Max. 100W)
 Features: **Double-Layer Shade**

LS-2875SS/GREY ③
 LS-2875SS/WHT ④ · Egg Table Lamp
 Body: Satin Steel / Metal
 Shade: Grey or White Pleated / Vinyl
 Switch: On/Off In-Line
 Lamp: E-27 Medium Base (Max. 60W)
 Features: **Double-Layer Shade**



*Scan For Video
Presentation*





Scan For Video
Presentation

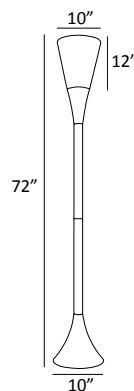
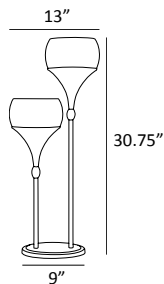
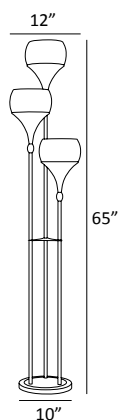

LS-82225 ① · Celestel Floor Lamp

Body: Chrome / Metal
Shade: Frosted / Glass
Switch: On/Off Foot
Lamp: E-27 Medium Base (Max. 60W) x2

LS-22225 ② · Celestel Table Lamp

Body: Chrome / Metal
Shade: Frosted / Glass
Switch: On/Off In-Line
Lamp: E-27 Medium Base (Max. 60W) x2

LS-83150 ③ · Willes Torchiere Lamp

Body: Brushed Nickel / Metal
Shade: Frosted / Glass
Switch: On/Off Foot
Lamp: E-27 Medium Base (Max. 100W)

QUANA



LS-83033BN ① / LS-83033BLK ② / LS-83033WHT ③

· Quana 3-Lite Arc Floor Lamp

Body: Brushed Nickel, Black or White / Metal

Shade: Matching Finish / Metal

Switch: 3-Way Rotary on Pole

Lamp: E-27 Medium Base (Max. 60W) x3

Features: **3-Way Switch, Adjustable Shade, Marble Base**

CONTEMPORARY



LS-23032BN ① / LS-23032BLK ② / LS-23032WHT ③
 · Quana Table Lamp

Body: Brushed Nickel, Black or White / Metal
 Shade: Matching Finish / Metal
 Switch: On/Off In-Line
 Lamp: E-12 Candelabra Base (Max. 60W)
 Features: **Adjustable Shade, Tripod Stand**

LS-83032BN ④ / LS-83032BLK ⑤ / LS-83032WHT ⑥
 · Quana Floor Lamp

Body: Brushed Nickel, Black or White / Metal
 Shade: Matching Finish / Metal
 Switch: On/Off Foot
 Lamp: E-12 Candelabra Base (Max. 60W)
 Features: **Adjustable Shade, Tripod Stand**



ARDEN

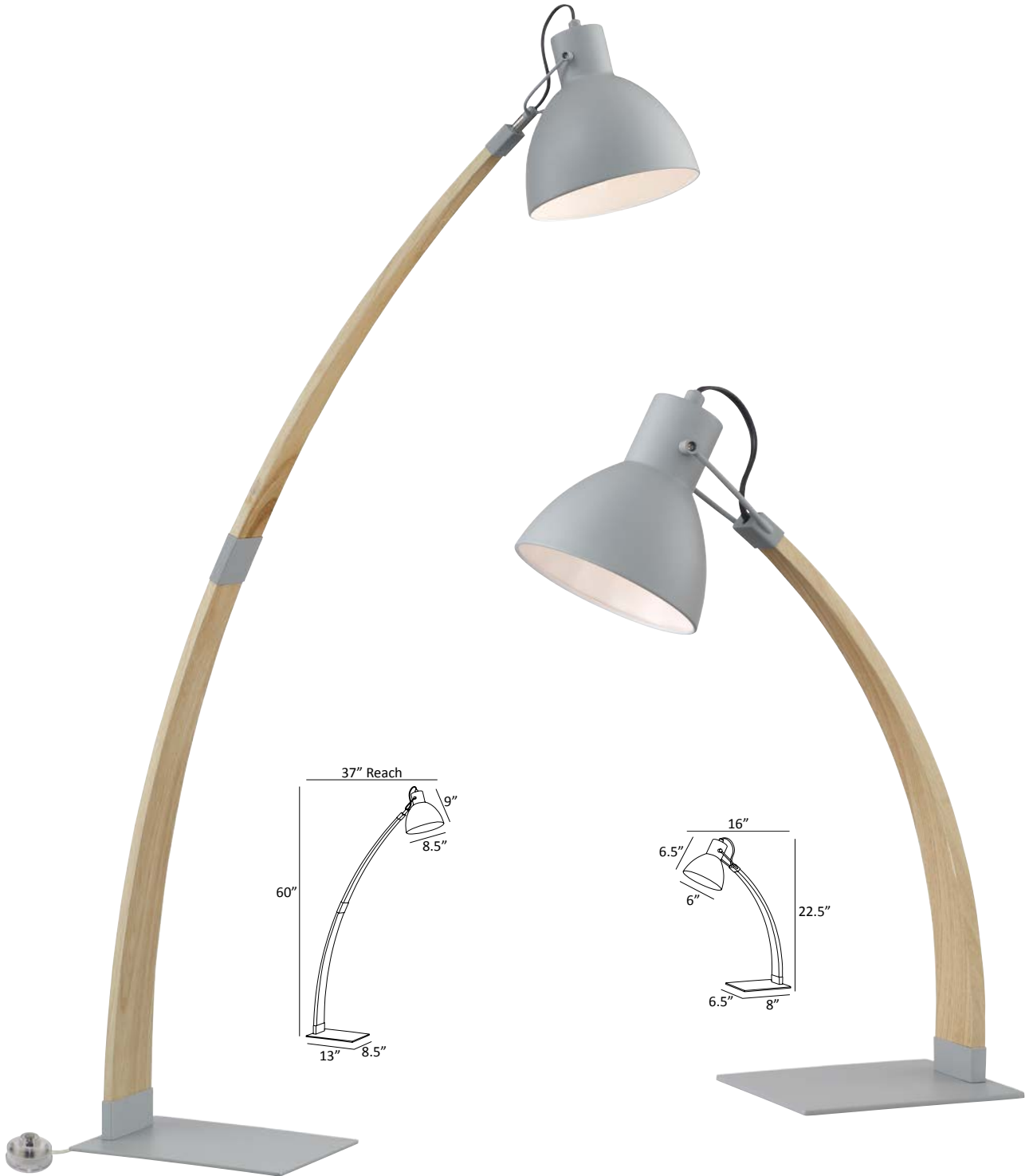

LS-83045 · Arden Floor Lamp
 Body: Natural Wood / Grey Metal
 Shade: Grey / Metal
 Switch: On/Off Foot
 Lamp: E-27 Medium Base (Max. 100W)
 Features: **Adjustable Shade**

LS-23045 · Arden Desk Lamp
 Body: Natural Wood / Grey Metal
 Shade: Grey / Metal
 Switch: On/Off In-Line
 Lamp: E-27 Medium Base (Max. 60W)
 Features: **Adjustable Shade**

CONTEMPORARY



LS-23048 · LeAnn Table Lamp
 Body: White / Metal / Natural / Wood
 Shade: Light Grey Flannel / Fabric
 Switch: On/Off In-Line
 Lamp: E-27 Medium Base (Max. 60W)
 Features: **Ajustable Arms**

LS-83048 · LeAnn Floor Lamp
 Body: White / Metal / Natural / Wood
 Shade: Light Grey Flannel / Fabric
 Switch: On/Off Foot
 Lamp: E-27 Medium Base (Max. 60W)
 Features: **Ajustable Arms**

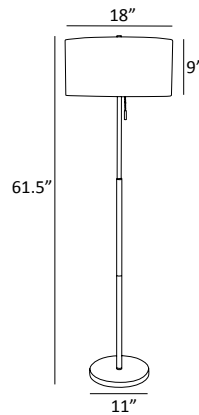
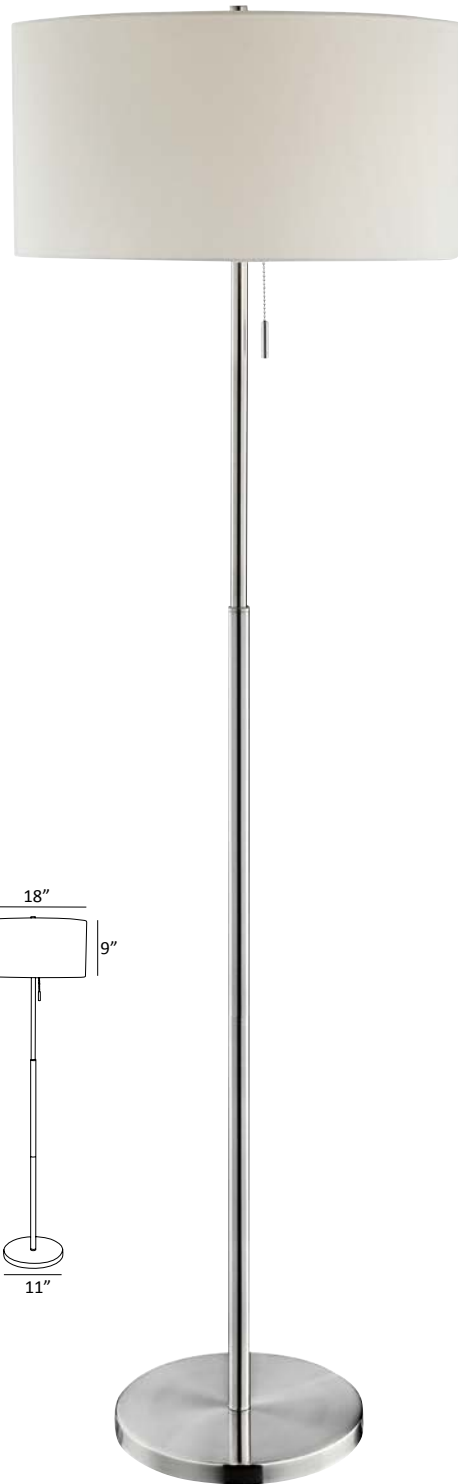
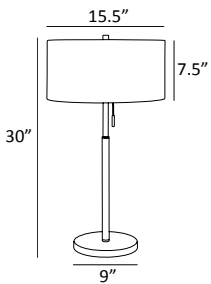

LS-23158 · Tomi 2-Lite Table Lamp

Body: Brushed Nickel / Metal
Shade: White / Fabric
Switch: 3-Way Pull-Chain
Lamp: E-27 Medium Base (Max. 60W) x2
Features: **2-Light, 3-Way Pull-Chain Switch**

LS-83158 · Tomi 2-Lite Floor Lamp

Body: Brushed Nickel / Metal
Shade: White / Fabric
Switch: 3-Way Pull-Chain
Lamp: E-27 Medium Base (Max. 60W) x2
Features: **2-Light, 3-Way Pull-Chain Switch**

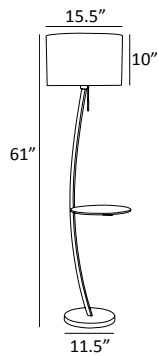
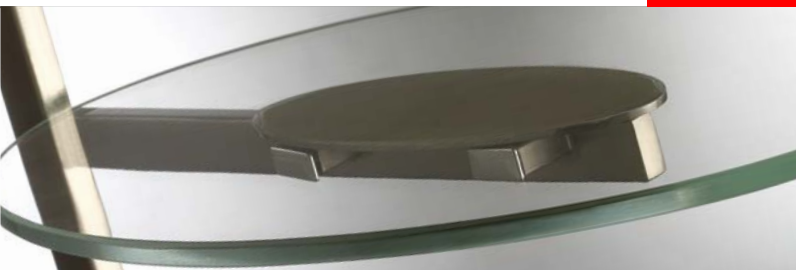

①

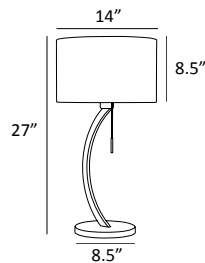

②

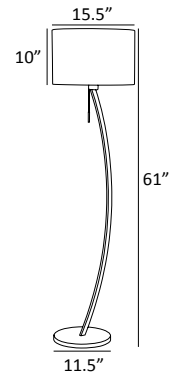
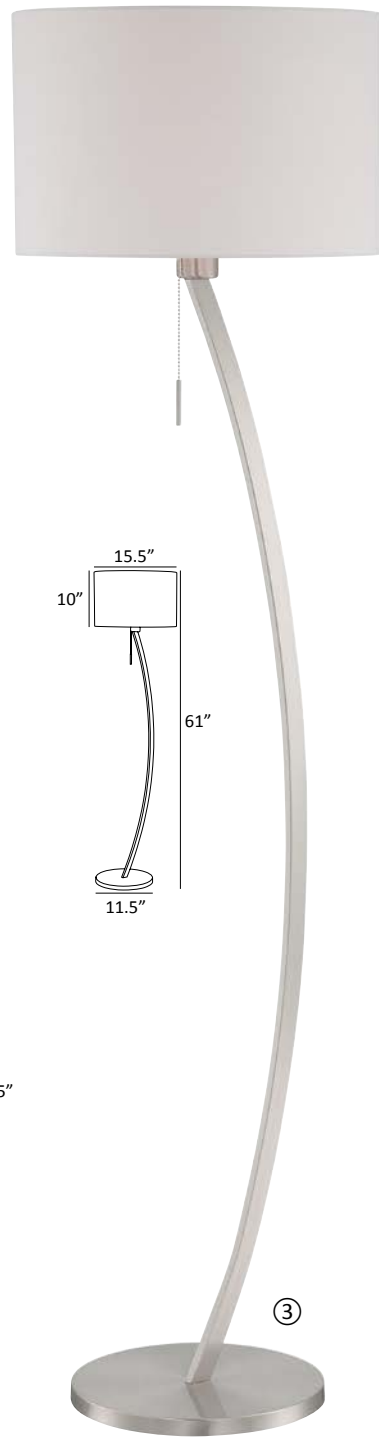

③

LS-82734 ① · Lilith Floor Lamp w. Table

Body: Satin Chrome / Metal
 Shade: Off-White / Fabric
 Switch: On/Off Pull-Chain
 Lamp: E-27 Medium Base (Max. 100W)
 Features: **Pull-Chain Switch, Glass Tray Table**

LS-22733 ② · Lilith Table Lamp

Body: Satin Chrome / Metal
 Shade: Off-White / Fabric
 Switch: On/Off Pull-Chain
 Lamp: E-27 Medium Base (Max. 60W)
 Features: **Pull-Chain Switch, Top Diffuser**

LS-82733 ③ · Lilith Floor Lamp

Body: Satin Chrome / Metal
 Shade: Off-White / Fabric
 Switch: On/Off Pull-Chain
 Lamp: E-27 Medium Base (Max. 100W)
 Features: **Pull-Chain Switch, Top Diffuser**



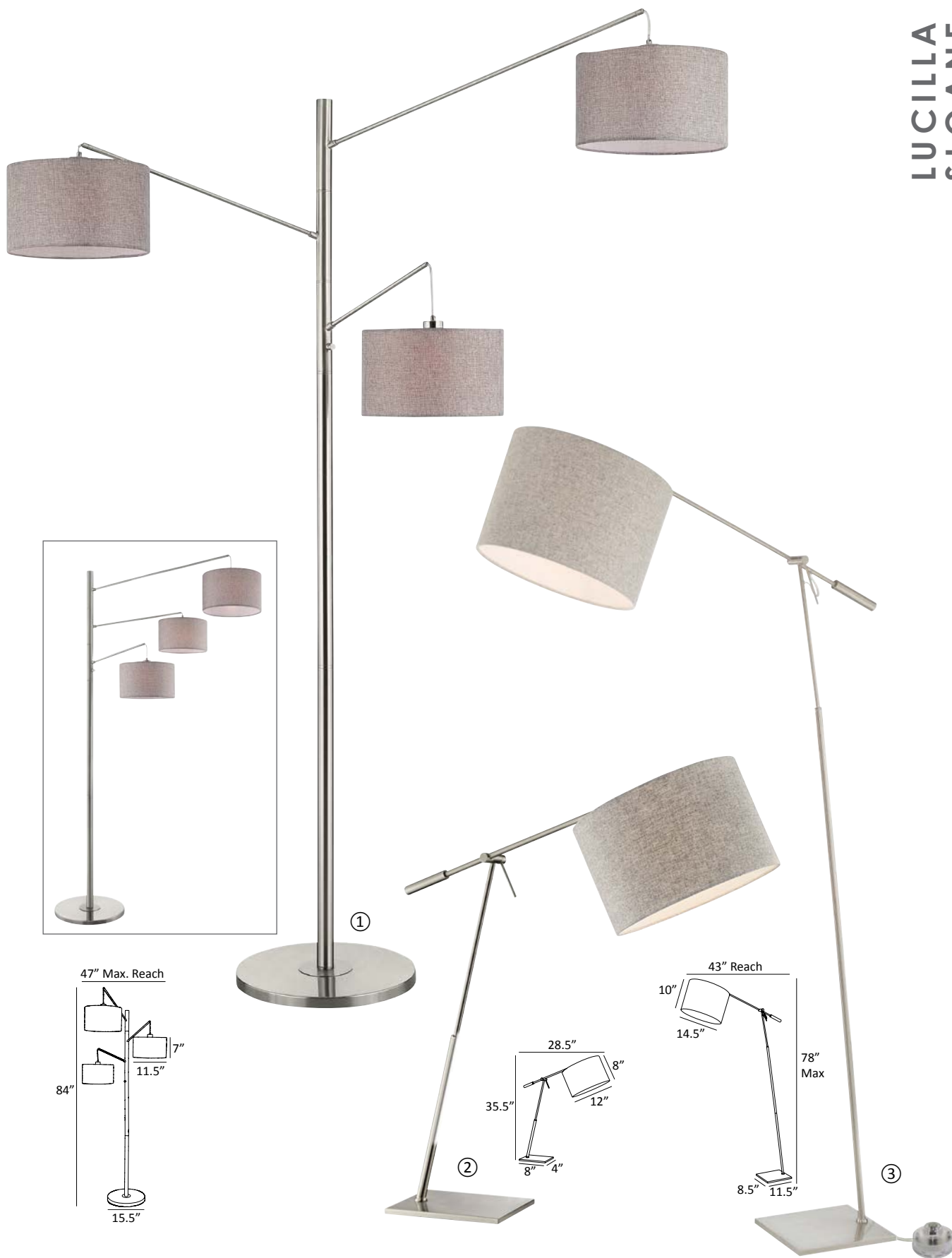

LS-83107 ① · Sloane 3-Lite Floor Lamp
 Body: Brushed Nickel / Metal
 Shade: Linen / Fabric
 Switch: 3-Way Rotary on Pole
 Lamp: E-27 Medium Base (Max. 60W) x3
 Features: **Swing Arms, 3-Way Switch, 3-Light**

LS-23050 ② · Lucilla Table Lamp
 Body: Brushed Nickel / Metal
 Shade: Light Grey Flannel / Fabric
 Switch: On/Off In-Line
 Lamp: E-27 Medium Base (Max. 60W)
 Features: **Adjustable Arm & Shade**

LS-83050 ③ · Lucilla Floor Lamp
 Body: Brushed Nickel / Metal
 Shade: Light Grey Flannel / Fabric
 Switch: On/Off Foot
 Lamp: E-27 Medium Base (Max. 100W)
 Features: **Adjustable Arm & Shade**



LS-20751PS ① · Relaxar Table Lamp
 Body: Polished Steel / Metal
 Shade: 2-Tone Textured / Fabric
 Switch: 3-Way Socket
 Lamp: E-27 Medium Base (Max. 150W)
 Features: **3-Way Switch**

LS-80751PS ② · Relaxar Floor Lamp
 Body: Polished Steel / Metal
 Shade: 2-Tone Textured / Fabric
 Switch: 3-Way Socket
 Lamp: E-27 Medium Base (Max. 150W)
 Features: **3-Way Switch**

LS-80753PS ③ · Relaxar 3-Lite Arc Lamp
 Body: Polished Steel / Metal
 Shade: 2-Tone Textured / Fabric
 Switch: 3-Way Rotary on Pole
 Lamp: E-12 Candelabra Base (Max. 40W) x3
 Features: **3-Way Switch, 3-Light**

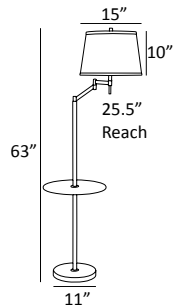
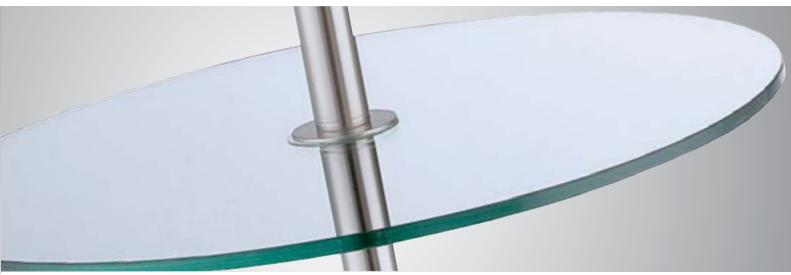

①

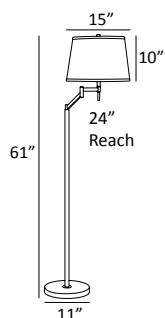

②

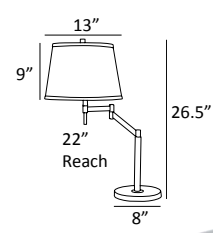

③

LS-82139 ① · Eveleen Floor Lamp w. Table
 Body: Brushed Nickel / Metal
 Shade: Off-White / Fabric
 Switch: On/Off Socket
 Lamp: E-27 Medium Base (Max. 100W)
 Features: **Swing Arm, Clear Glass Table Top**

LS-82138 ② · Eveleen Floor Lamp
 Body: Brushed Nickel / Metal
 Shade: Off-White / Fabric
 Switch: On/Off Socket
 Lamp: E-27 Medium Base (Max. 100W)
 Features: **Swing Arm**

LS-22139 ③ · Eveleen Table Lamp
 Body: Brushed Nickel / Metal
 Shade: Off-White / Fabric
 Switch: On/Off Socket
 Lamp: E-27 Medium Base (Max. 100W)
 Features: **Swing Arm**

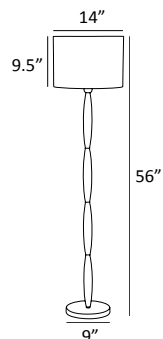
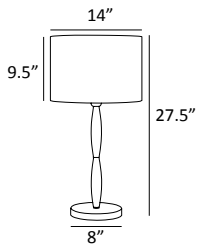
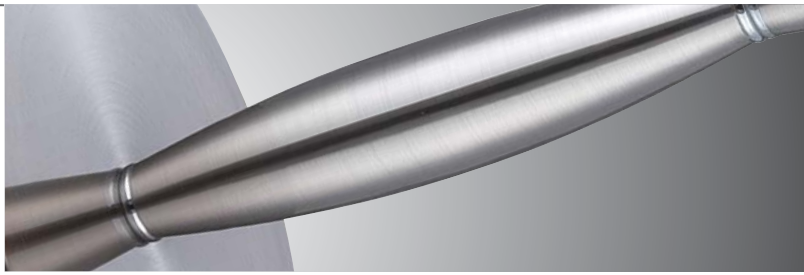

LS-22336 · Cira Table Lamp

Body: Brushed Nickel / Metal
 Shade: Off-White / Fabric
 Switch: On/Off Socket
 Lamp: E-27 Medium Base (Max. 100W)

LS-82336 · Cira Floor Lamp

Body: Brushed Nickel / Metal
 Shade: Off-White / Fabric
 Switch: On/Off Socket
 Lamp: E-27 Medium Base (Max. 100W)

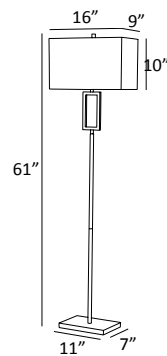
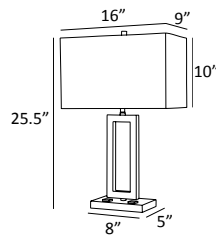
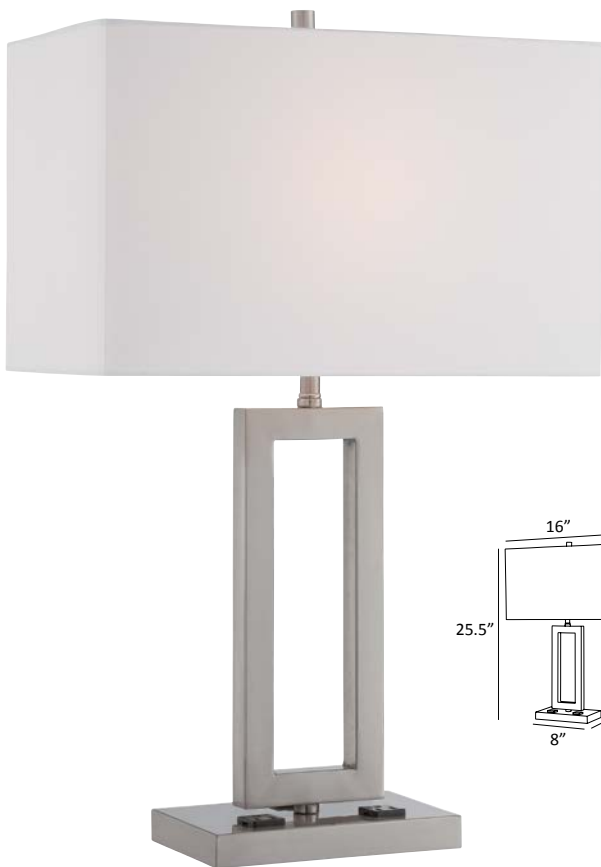

LS-22638 · Fiadi Table Lamp

Body: Brushed Nickel / Metal
 Shade: Off-White / Fabric
 Switch: On/Off Rocker on Base
 Lamp: E-27 Medium Base (Max. 100W)
 Features: **AC Outlet x2**

LS-82638 · Fiadi Floor Lamp

Body: Brushed Nickel / Metal
 Shade: Off-White / Fabric
 Switch: On/Off Socket
 Lamp: E-27 Medium Base (Max. 100W)

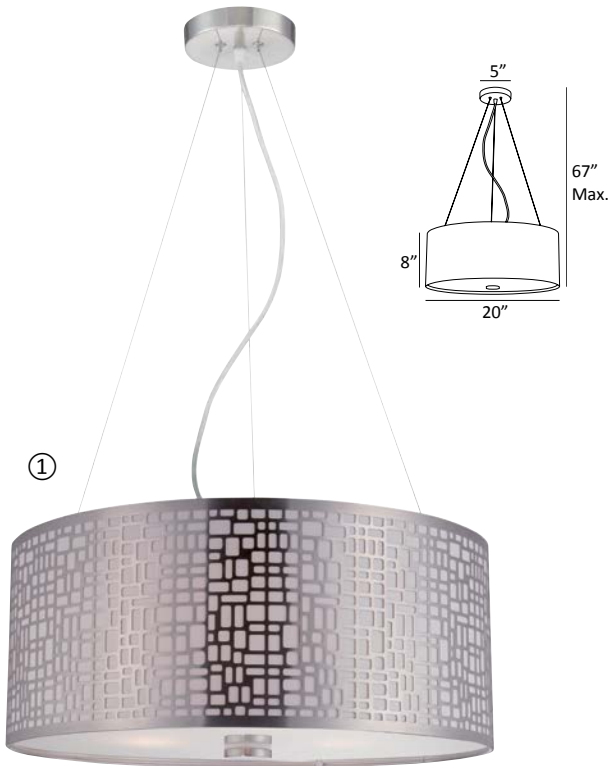

①

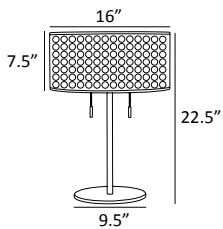

③

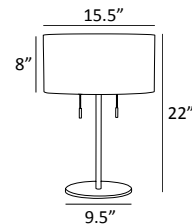
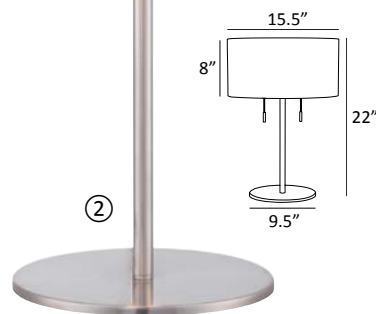

②

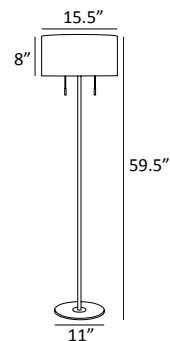

④

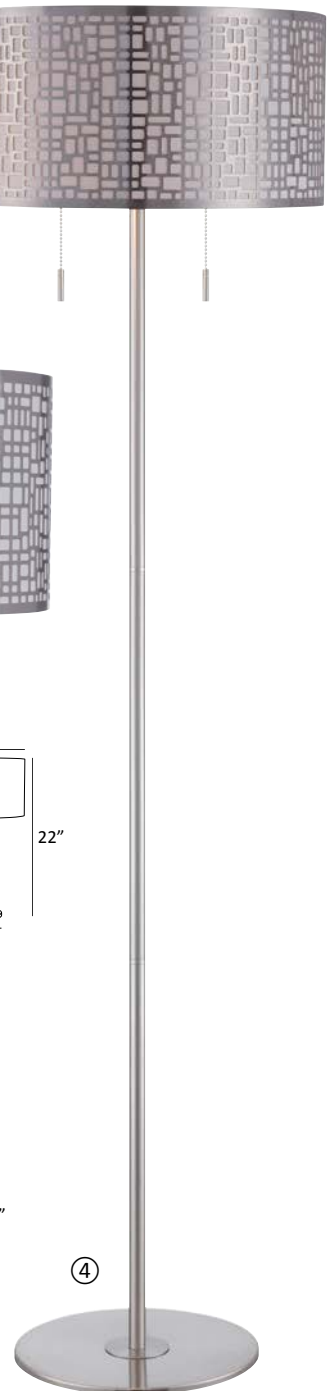

LS-19174PS ① · Torre Pendant

Body: Polished Steel / Metal
Shade: Laser-Cut Meta / Vinyl Liner / Frosted Glass Diffuser
Lamp: E-27 Medium Base (Max. 60W) x3

LS-22174PS ② · Torre Table Lamp

Body: Polished Steel / Metal
Shade: Laser-Cut Meta / Vinyl Liner / Frosted Glass Diffuser
Switch: On/Off Dual Pull-Chain
Lamp: E-27 Medium Base (Max. 60W) x2

LS-21519PS ③ · Netto Table Lamp

Body: Polished Steel / Metal
Shade: Laser Cut Metal / Vinyl Liner / Frosted Glass Diffuser
Switch: On/Off Dual Pull-Chain
Lamp: E-27 Medium Base (Max. 60W) x2

LS-82174PS ④ · Torre Floor Lamp

Body: Polished Steel / Metal
Shade: Laser-Cut Meta / Vinyl Liner / Frosted Glass Diffuser
Switch: On/Off Dual Pull-Chain
Lamp: E-27 Medium Base (Max. 60W) x2

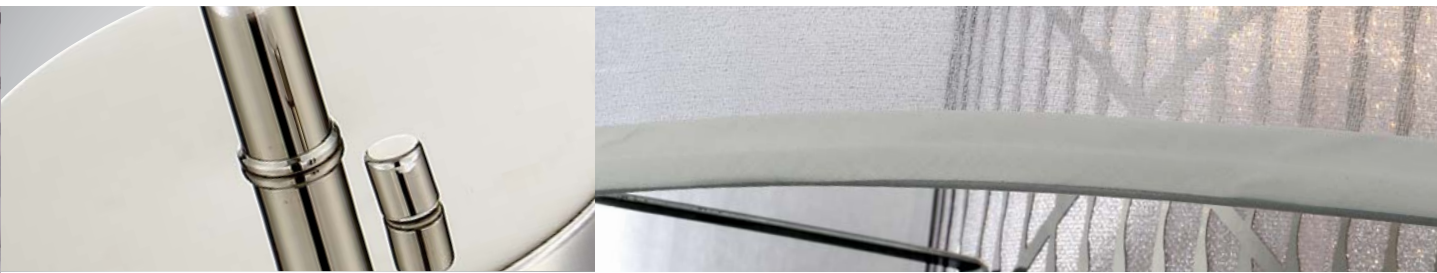

Scan For Video Presentation

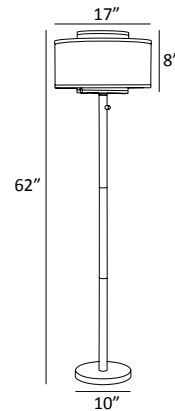
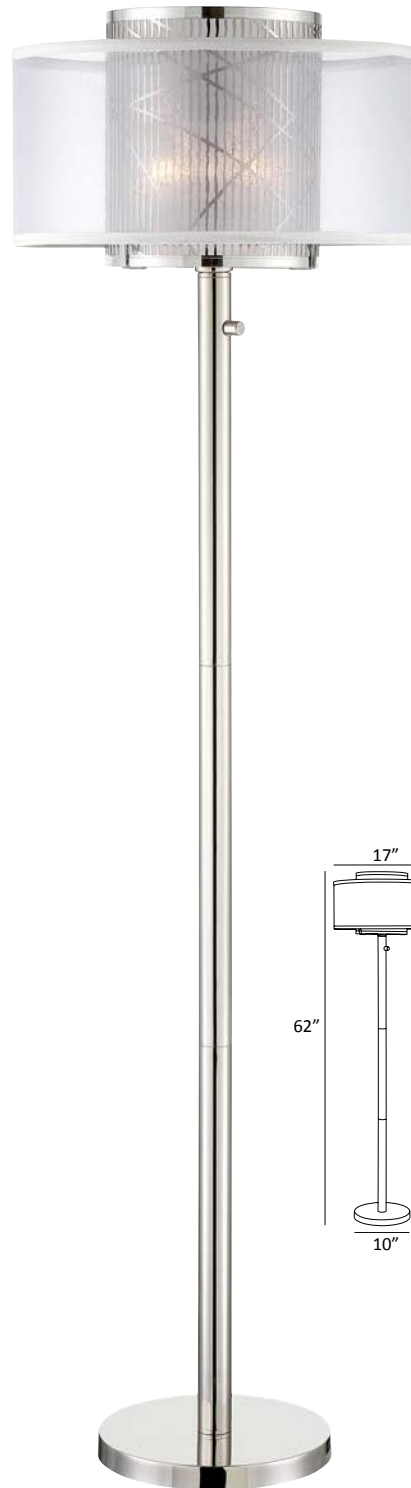
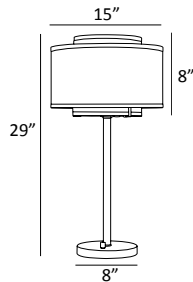

LS-22888 · Lacole Table Lamp

Body: Chrome / Metal
 Shade: Clear Organza / Laser-Cut Chrome Metal
 Switch: Dimmer on Base
 Lamp: E-27 Medium Base (Max. 100W)
 Features: **Dimmer Switch, Double-Layer Shade, 72W A16 Halogen Bulb Included**

LS-82888 · Lacole Floor Lamp

Body: Chrome / Metal
 Shade: Clear Organza / Laser-Cut Chrome Metal
 Switch: Dimmer on Pole
 Lamp: E-27 Medium Base (Max. 100W)
 Features: **Dimmer Switch, Double-Layer Shade, 72W A16 Halogen Bulb Included**



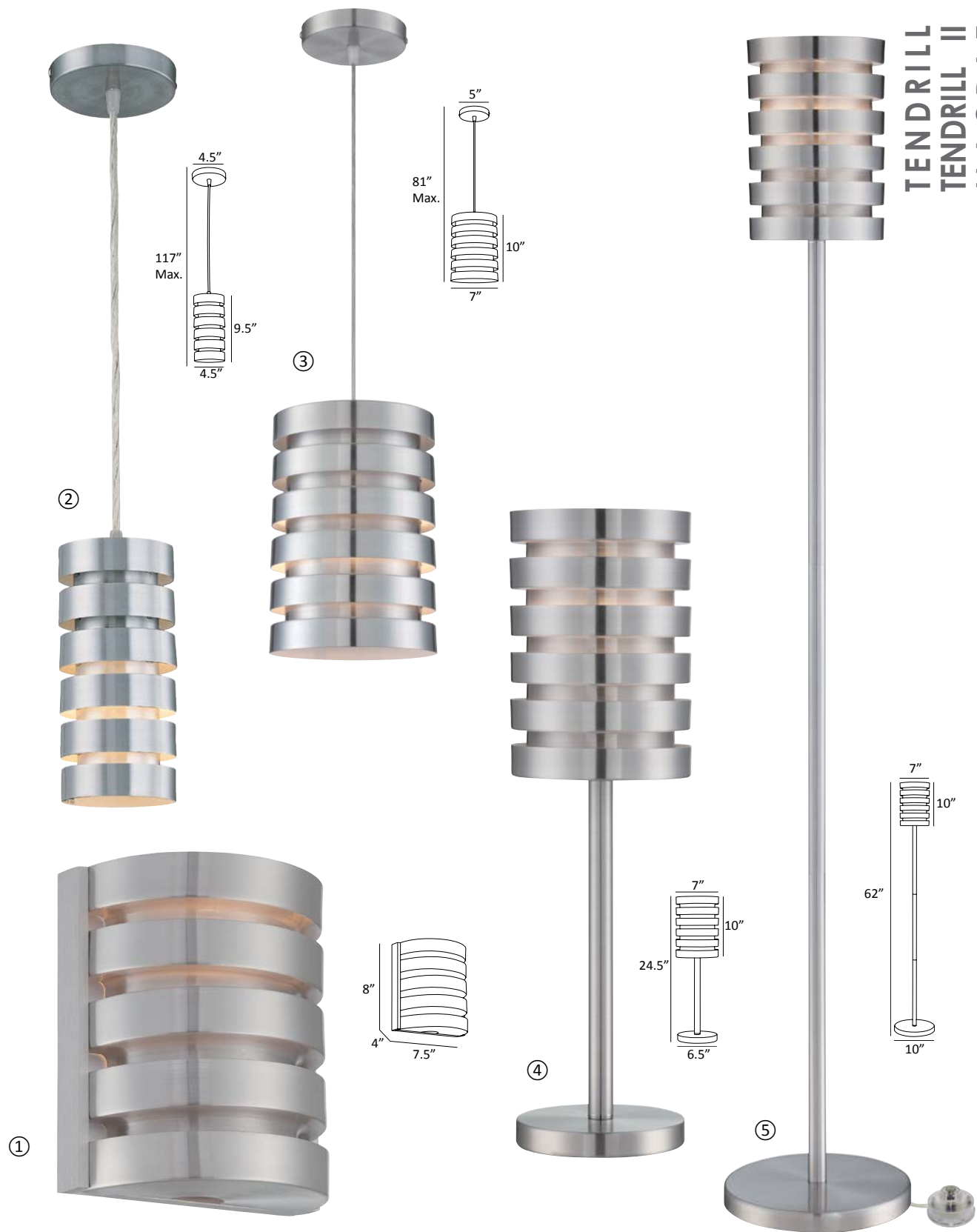

LS-16815 ① · Macrae Wall Sconce
 Body: Aluminum / Metal
 Shade: Aluminum / Metal
 Lamp: E-27 Medium Base (Max. 60W)

LS-19921ALU ② · Tendrill Mini-Pendant
 Body: Aluminum / Metal
 Shade: Aluminum / Metal
 Lamp: E-27 Medium Base (Max. 60W)

LS-19923ALU ③ · Tendrill II Pendant
 Body: Aluminum / Metal
 Shade: Aluminum / Metal
 Lamp: E-27 Medium Base (Max. 60W)

LS-22923ALU ④ · Tendrill II Table Lamp
 Body: Aluminum / Metal
 Shade: Aluminum / Metal
 Switch: On/Off In-Line
 Lamp: E-27 Medium Base (Max. 60W)

LS-82923ALU ⑤ · Tendrill II Floor Lamp
 Body: Aluminum / Metal
 Shade: Aluminum / Metal
 Switch: On/Off Foot
 Lamp: E-27 Medium Base (Max. 100W)



LS-22305 ① · Seville Table Lamp

Body: Satin Nickel / Metal
 Shade: Silver Finish Mesh / Paper
 Switch: On/Off Pull-Chain
 Lamp: E-27 Medium Base (Max. 100W)
 Features: **Double-Layer Shade**

LS-22767 ② · Lanelle Table Lamp

Body: Chrome / Metal
 Shade: Chrome Metal / Frosted Glass
 Switch: On/Off In-Line
 Lamp: E-27 Medium Base (Max. 60W) x2
 Features: **Double-Layer Shade**

LS-82767 ③ · Lanelle Floor Lamp

Body: Chrome / Metal
 Shade: Chrome Metal / Frosted Glass
 Switch: On/Off Foot
 Lamp: E-27 Medium Base (Max. 60W) x2
 Features: **Double-Layer Shade**



①

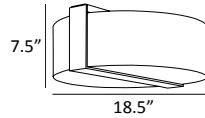

②

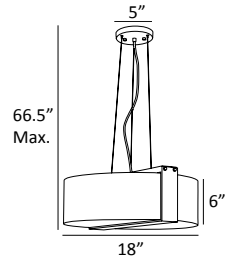

③

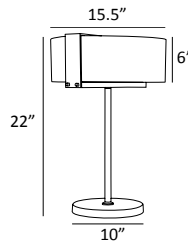

④

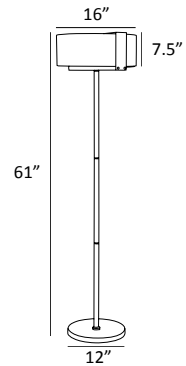

LS-5866 ① · Rogina Flush-Mount

Body: Chrome / Metal
 Shade: Frosted / Glass
 Lamp: E-27 Medium Base (60W) x3

LS-19866 ② · Rogina Pendant

Body: Chrome / Metal
 Shade: Frosted / Glass
 Lamp: E-27 Medium Base (60W) x3

LS-22866 ③ · Rogina Table Lamp

Body: Chrome / Metal
 Shade: Frosted / Glass
 Switch: On/Off In-Line
 Lamp: E-27 Medium Base (60W) x2

LS-82866 ④ · Rogina Floor Lamp

Body: Chrome / Metal
 Shade: Frosted / Glass
 Switch: On/Off Foot
 Lamp: E-27 Medium Base (60W) x3

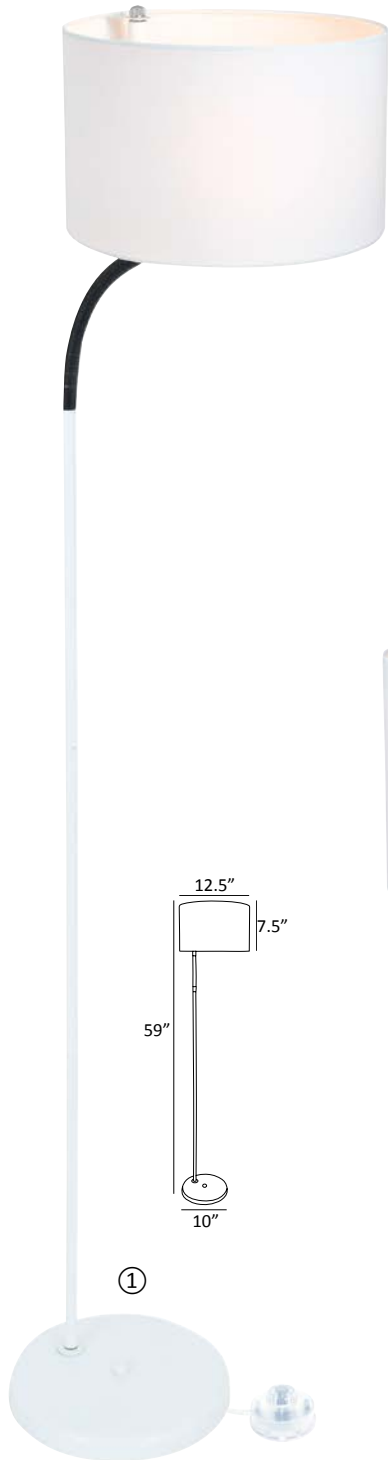

Black Gooseneck

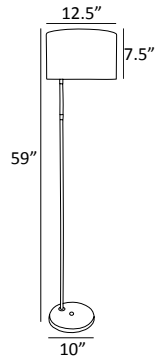
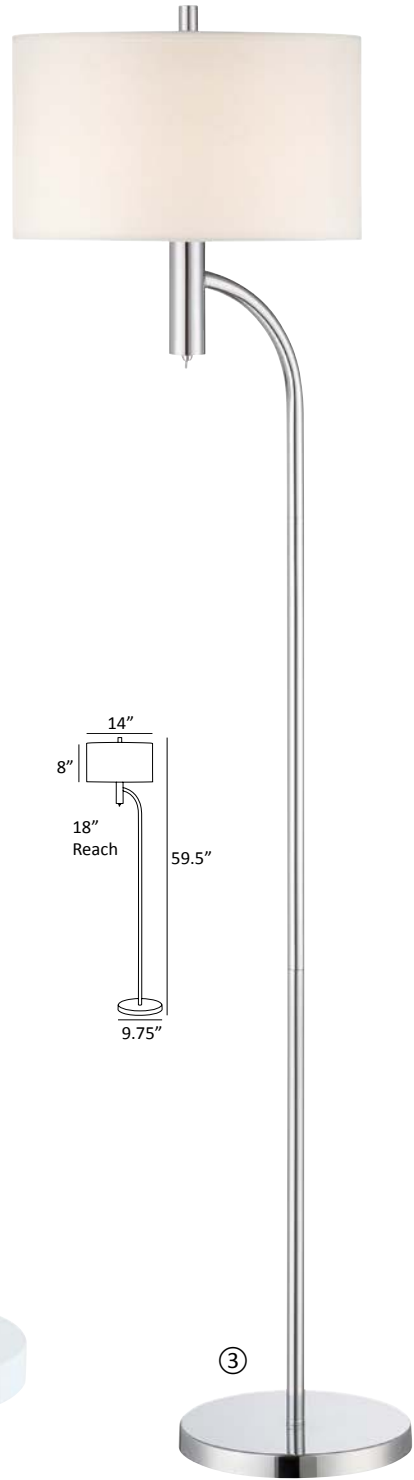

①

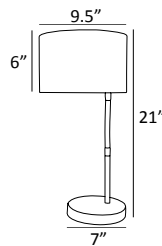

②

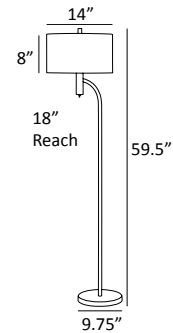

③

LS-82623 ① · Gillian Floor Lamp

Body: White / Metal
Shade: White / Fabric
Switch: On/Off Foot
Lamp: E-27 Medium Base (Max. 100W)
Features: **Gooseneck**

LS-22623 ② · Gillian Table Lamp

Body: White / Metal
Shade: White / Fabric
Switch: On/Off In-Line
Lamp: E-27 Medium Base (Max. 60W)
Features: **Gooseneck**

LS-82232 ③ · Chantay Floor Lamp

Body: Chrome / Metal
Shade: Off-White / Kraft Paper
Switch: On/Off Toggle
Lamp: E-27 Medium Base (Max. 100W)
Features: **Toggle Switch**



LS-18626 ① · Nodin Pendant

Body: Brushed Nickel / Metal
 Shade: Transparent PVC / White Fabric
 Lamp: E-27 Medium Base (Max. 100W) x2
 Features: **Double-Layer Shade**

LS-22626 ② · Nodin Table Lamp

Body: Brushed Nickel / Metal
 Shade: Transparent PVC / White Fabric
 Switch: On/Off Dual Pull-Chain
 Lamp: E-27 Medium Base (Max. 60W) x2
 Features: **Double-Layer Shade**

LS-82626 ③ · Nodin Floor Lamp

Body: Brushed Nickel / Metal
 Shade: Transparent PVC / White Fabric
 Switch: On/Off Dual Pull-Chain
 Lamp: E-27 Medium Base (Max. 60W) x2
 Features: **Double-Layer Shade**

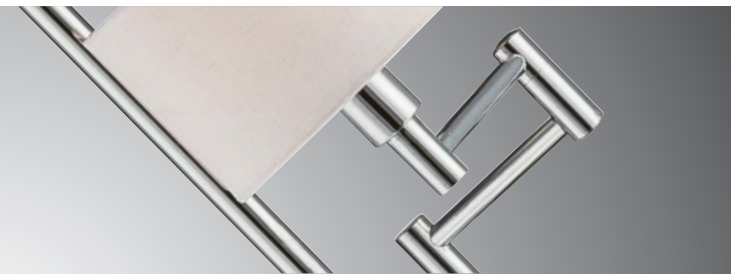

LS-22215PS/WHT ①

· Durango Table Lamp

Body: Polished Steel / Metal

Shade: Off-White / Fabric

Switch: On/Off Socket

Lamp: E-27 Medium Base (Max. 60W)

Features: **Swing Arm**

LS-82215PS/WHT ②

· Durango Floor Lamp

Body: Polished Steel / Metal

Shade: Off-White / Fabric

Switch: On/Off Socket

Lamp: E-27 Medium Base (Max. 100W)

Features: **Swing Arm**

LS-81866 ③ · Lise Floor Lamp

Body: Chrome / Metal

Shade: Off-White / Fabric

Switch: 3-Way Socket

Main Lamp: E-27 Medium Base (Max. 150W)

Reading Lamp: E-12 Candelabra Base (Max. 40W)

Features: **Reading Lamp with Swing Arm, 3-Way Switch**

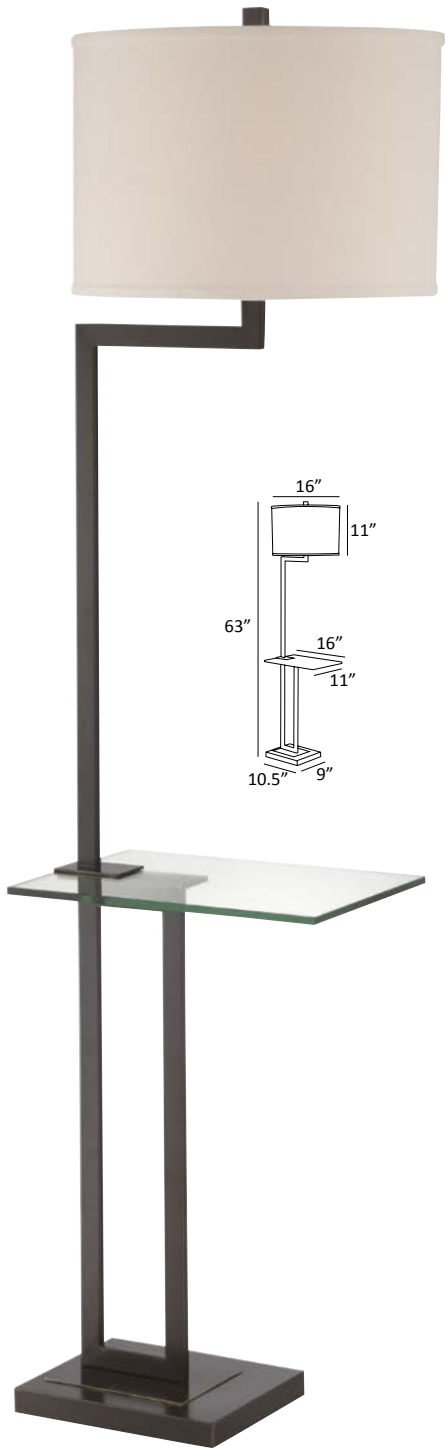
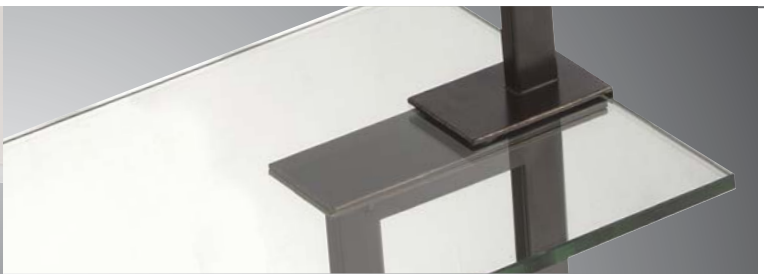

LS-81746D/BRZ · Rudko Floor Lamp

Body: Dark Bronze / Metal
 Shade: Linen / Fabric
 Switch: 3-Way Socket
 Lamp: E-27 Medium Base (Max. 150W)
 Features: **3-Way Switch, Clear Glass Tray Table**

LS-81746PS/WHT · Rudko Floor Lamp

Body: Polished Steel / Metal
 Shade: Off-White / Fabric
 Switch: 3-Way Socket
 Lamp: E-27 Medium Base (Max. 150W)
 Features: **3-Way Switch, Clear Glass Tray Table**

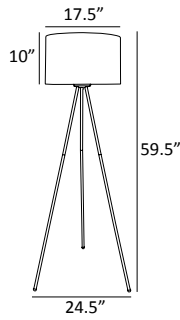
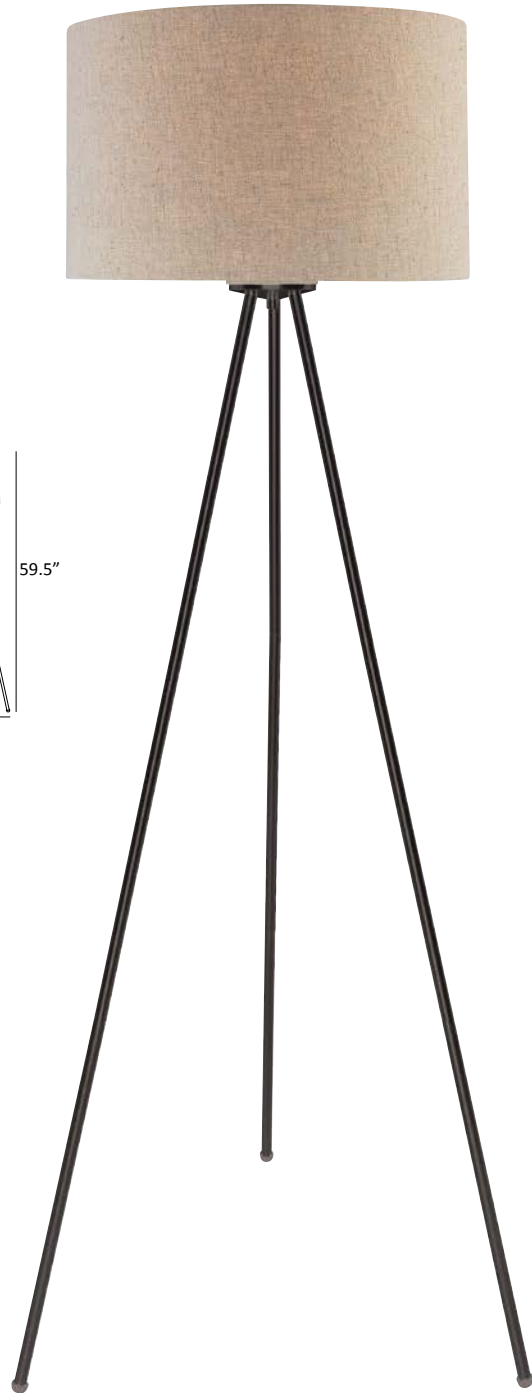
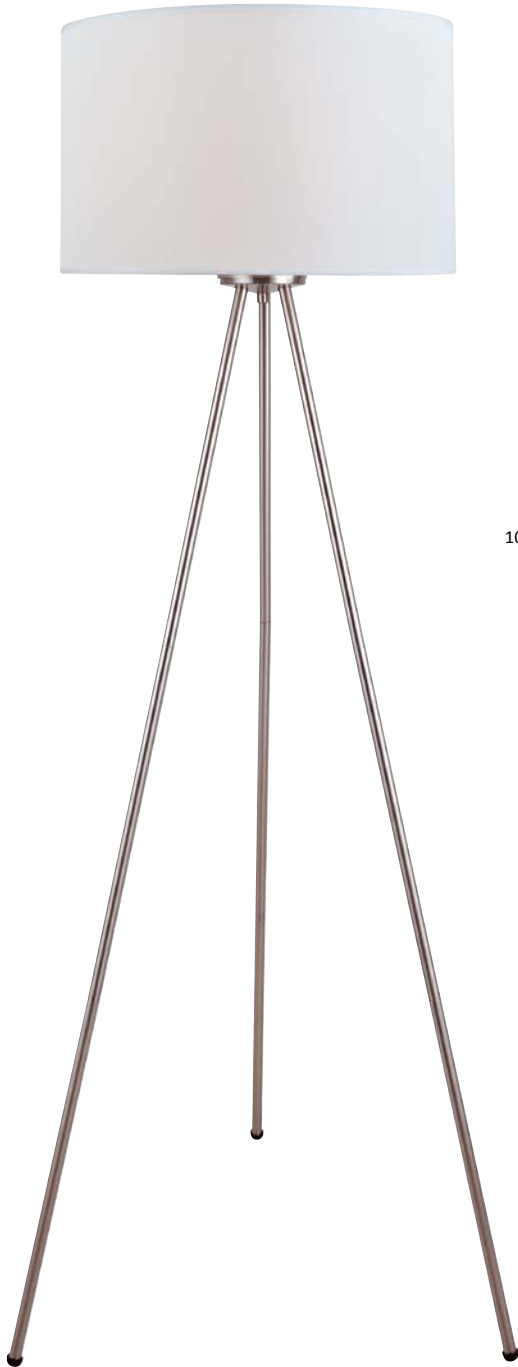

LS-82065 · Tullio Floor Lamp

Body: Polished Steel / Metal
 Shade: Off-White / Fabric
 Switch: On/Off Socket
 Lamp: E-27 Medium Base (Max. 100W)
 Features: **Tripod Stand**

LS-82065D/BRZ · Tullio Floor Lamp

Body: Dark Bronze / Metal
 Shade: Light Beige / Fabric
 Switch: On/Off Socket
 Lamp: E-27 Medium Base (Max. 100W)
 Features: **Tripod Stand**



LS-83051BN/GREY · Hooper Arc Lamp

Body: Brushed Nickel / Metal
Shade: Grey Flannel / Fabric
Switch: On/Off Socket
Lamp: E-27 Medium Base (Max. 100W)

LS-83051BN/WHT · Hooper Arc Lamp

Body: Brushed Nickel / Metal
Shade: Grey Flannel or White / Fabric
Switch: On/Off Socket
Lamp: E-27 Medium Base (Max. 100W)





LS-82053C ① · Ilario II Arc Floor Lamp

Body: Chrome I / Marble
 Shade: Frosted / Glass
 Switch: 3-Way Rotary on Pole
 Lamp: E-12 Candelabra Base (Max. 60W) x5
 Features: **3-Way Switch, 5-Light, Marble Base**

LS-82053G ② · Ilario II Arc Floor Lamp

Body: Gun Metal / Marble
 Shade: Frosted / Glass
 Switch: 3-Way Rotary on Pole
 Lamp: E-12 Candelabra Base (Max. 60W) x5
 Features: **3-Way Switch, 5-Light, Marble Base**

LS-82268 ③ · Linterna 3-Lite Arc Lamp

Body: Brushed Nickel / Metal
 Shade: Natural Wickered / Bamboo
 Switch: 3-Way Rotary on Pole
 Lamp: E-27 Medium Base (Max. 60W) x3
 Features: **3-Way Switch, 3-Light**

WALLACE

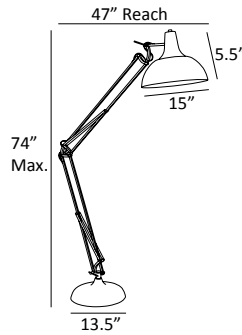
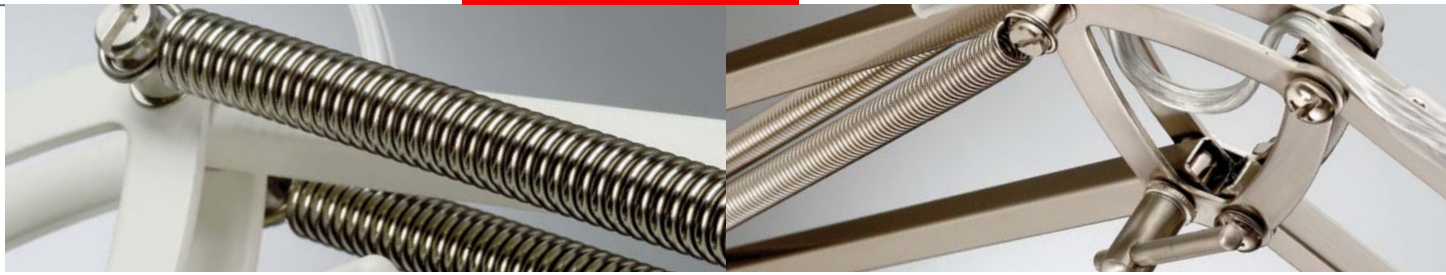

CONTEMPORARY

LS-83028BN · Wallace Floor Lamp

Body: Brushed Nickel / Metal
Shade: Matching Finish / Metal
Switch: On/Off Foot
Lamp: E-27 Medium Base (Max. 100W)
Features: **Balanced-Arm, Adjustable Shade**

LS-83028WHT · Wallace Floor Lamp

Body: Brushed Nickel / Metal
Shade: Matching Finish / Metal
Switch: On/Off Foot
Lamp: E-27 Medium Base (Max. 100W)
Features: **Balanced-Arm, Adjustable Shade**



LS-82939 ① · Triton Arc Floor Lamp

Body: Brushed Nickel Metal / Black Marble
 Shade: Brushed Nickel / Metal
 Switch: On/Off Foot
 Lamp: E-27 Medium Base (Max. 100W)
 Features: **Adjustable Shade, Marble Base**

LS-83215 ② · Julian Floor Lamp

Body: Brushed Nickel / Metal
 Shade: White / Fabric
 Switch: On/Off Foot
 Lamp: E-27 Medium Base (Max. 100W)
 Features: **Adjustable Shade**

LS-83266C ③ · Marcelo Arc Floor Lamp

Body: Chrome / Metal
 Shade: Chrome / Metal
 Switch: On/Off Foot
 Lamp: E-27 Medium Base (Max. 60W)
 Features: **Adjustable Shade, Adjustable Height**

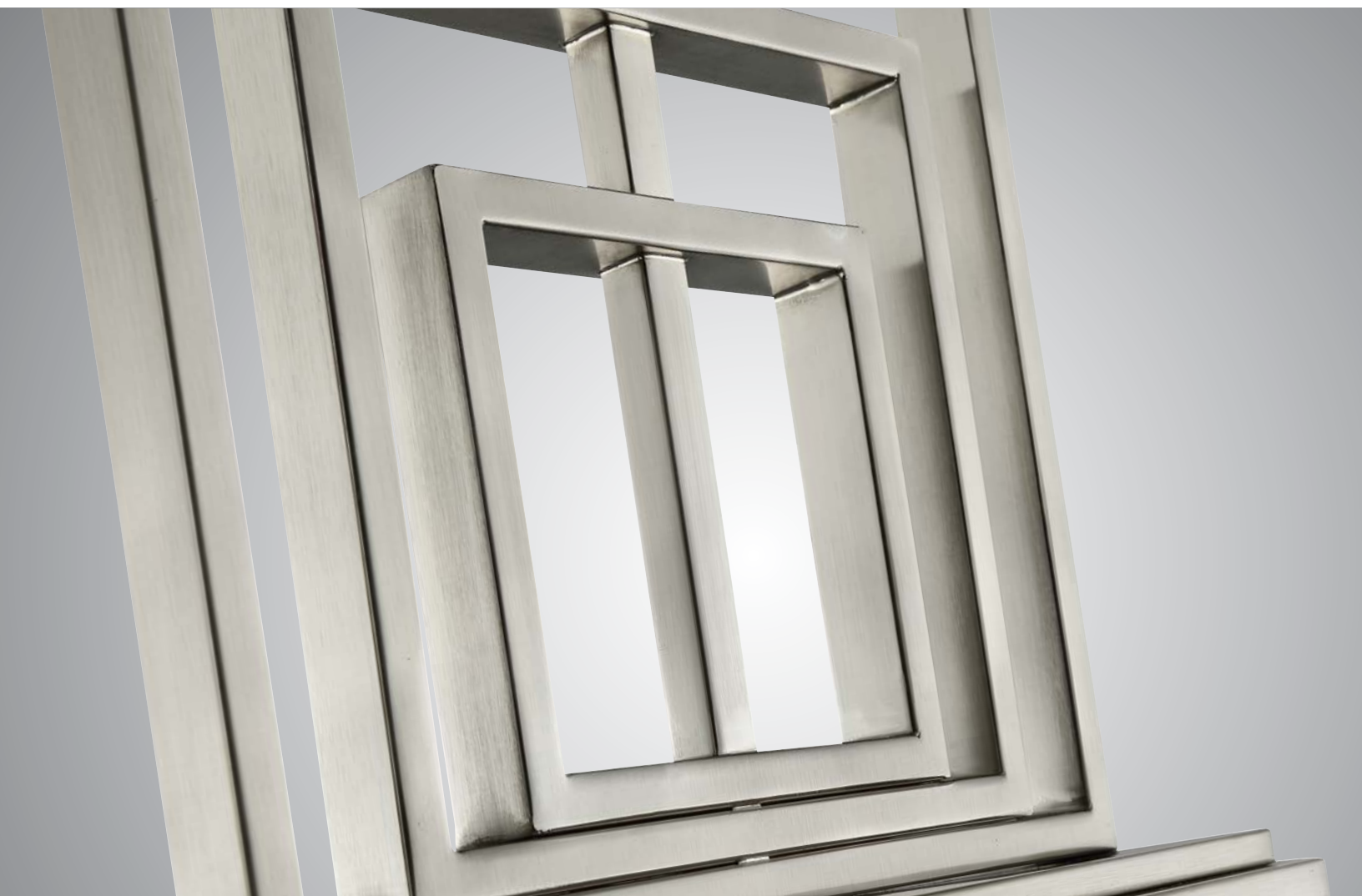



Scan For Video Presentation



Scan For Video Presentation

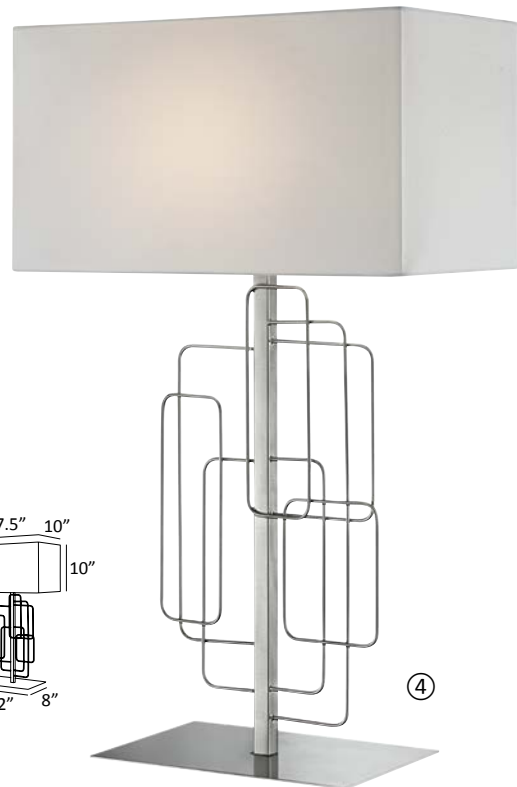
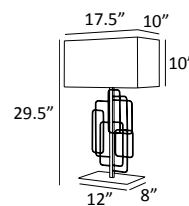

LS-23088 ①
LS-23089 ② · Bensky Table Lamp
 Body: Brushed Nickel / Metal
 Shade: White / Fabric
 Switch: On/Off Socket
 Lamp: E-27 Medium Base (Max. 100W)

LS-23090 ③ · Bailee Table Lamp
 Body: Brushed Nickel / Metal
 Shade: White / Fabric
 Switch: On/Off Socket
 Lamp: E-27 Medium Base (Max. 100W)

LS-23153 ④ · Fayth Table Lamp
 Body: Brushed Nickel / Metal
 Shade: White / Fabric
 Switch: On/Off Socket
 Lamp: E-27 Medium Base (Max. 100W)

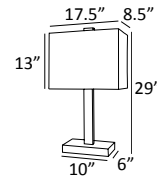
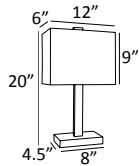
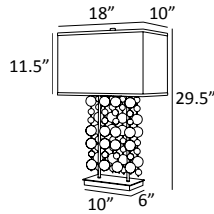
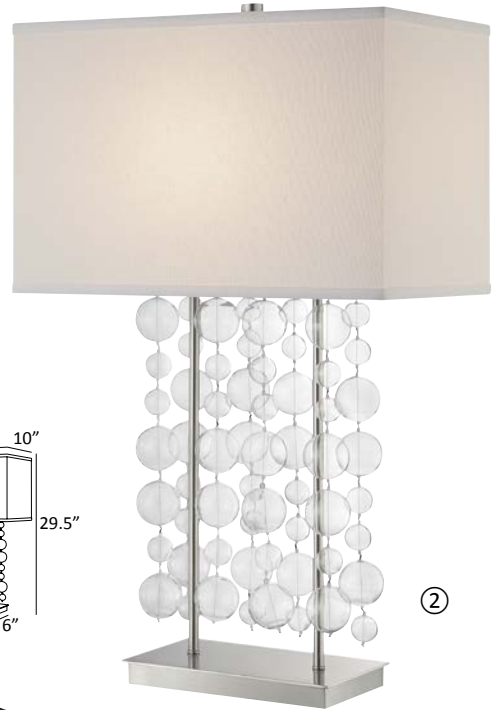
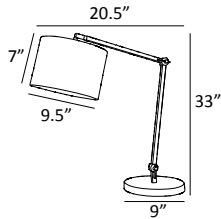

LS-23155 ① · Lark Table Lamp

Body: Brushed Nickel / Metal
Shade: White / Fabric
Switch: On/Off In-Line
Lamp: E-27 Medium Base (Max. 60W)
Features: **Adjustable Arm & Shade**

LS-23172 ② · Tribeca Table Lamp

Body: Brushed Nickel Metal / Clear Glass Droplets
Shade: White / Fabric
Switch: On/Off Socket
Lamp: E-27 Medium Base (Max. 100W)
Features: **Clear Glass Droplets**

LS-22316 ③ · Maddox Table Lamp

Body: Brushed Nickel Metal / Black PS
Shade: Off-White / Fabric
Switch: On/Off In-Line
Lamp: E-27 Medium Base (Max. 60W)

LS-23208 ④ · Maddox II Table Lamp

Body: Brushed Nickel Metal / Black PS
Shade: Off-White / Fabric
Switch: On/Off Rocker on Base
Lamp: E-27 Medium Base (Max. 60W)
Features: **USB Charging Port x1, AC Outlet x1**

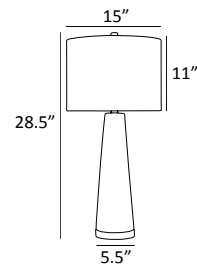
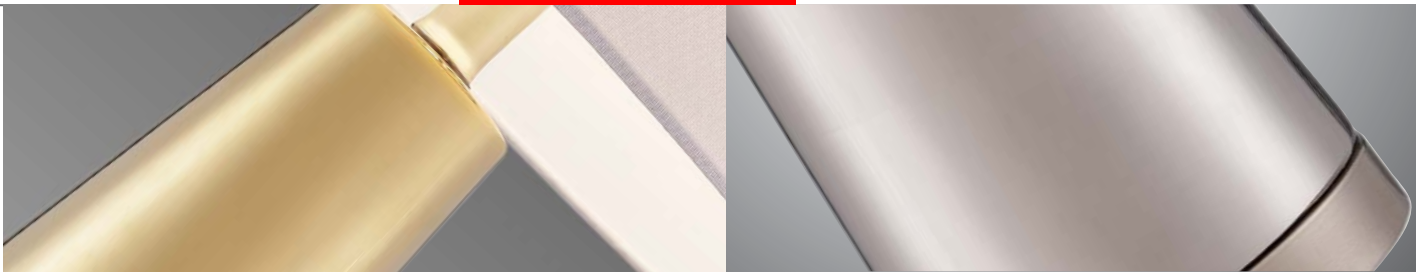

LS-23200GOLD ① · Tyrone Table Lamp
 Body: Light Gold / Ceramic
 Shade: White / Fabric
 Switch: 3-Way Socket
 Lamp: E-27 Medium Base (Max. 150W)
 Features: **3-Way Switch, Fabric Top Diffuser**

LS-23200SILV ② · Tyrone Table Lamp
 Body: Silver / Ceramic
 Shade: White / Fabric
 Switch: 3-Way Socket
 Lamp: E-27 Medium Base (Max. 150W)
 Features: **3-Way Switch, Fabric Top Diffuser**

LS-23200WHT ③ · Tyrone Table Lamp
 Body: White / Ceramic
 Shade: White / Fabric
 Switch: 3-Way Socket
 Lamp: E-27 Medium Base (Max. 150W)
 Features: **3-Way Switch, Fabric Top Diffuser**



①



②



③

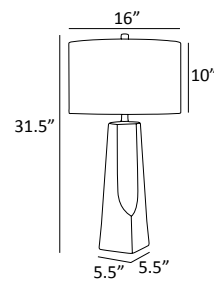

LS-23199GOLD ① · Tyrell Table Lamp
 Body: Light Gold / Ceramic
 Shade: White / Fabric
 Switch: 3-Way Socket
 Lamp: E-27 Medium Base (Max. 150W)
 Features: **3-Way Switch, Fabric Top Diffuser**

LS-23199SILV ② · Tyrell Table Lamp
 Body: Silver / Ceramic
 Shade: White / Fabric
 Switch: 3-Way Socket
 Lamp: E-27 Medium Base (Max. 150W)
 Features: **3-Way Switch, Fabric Top Diffuser**

LS-23199WHT ③ · Tyrell Table Lamp
 Body: White / Ceramic
 Shade: White / Fabric
 Switch: 3-Way Socket
 Lamp: E-27 Medium Base (Max. 150W)
 Features: **3-Way Switch, Fabric Top Diffuser**



①



②



③

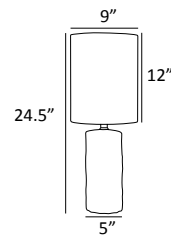

LS-23190G ① · Halsey Table Lamp

Body: Gunmetal / Ceramic

Shade: White / Fabric

Switch: On/Off Socket

Lamp: E-27 Medium Base (Max. 60W)

LS-23190GREY ② · Halsey Table Lamp

Body: Light Grey / Ceramic

Shade: White / Fabric

Switch: On/Off Socket

Lamp: E-27 Medium Base (Max. 60W)

LS-23190SILV ③ · Halsey Table Lamp

Body: Silver / Ceramic

Shade: White / Fabric

Switch: On/Off Socket

Lamp: E-27 Medium Base (Max. 60W)

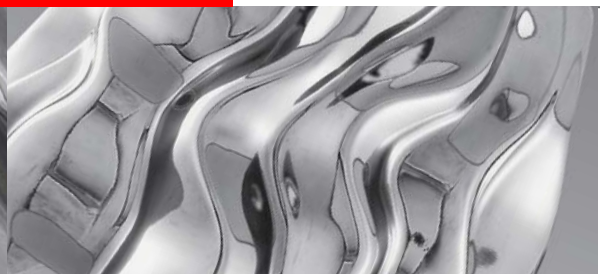

①

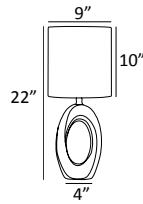

②

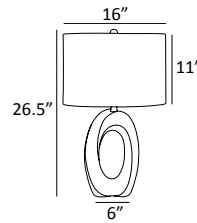

③

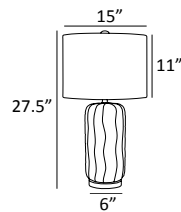

④

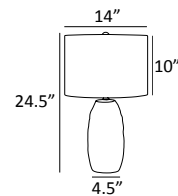

LS-23183 ①

LS-23184 ② · Clover Table Lamp

Body: Chrome / Ceramic

Shade: White / Fabric

Switch: On/Off Socket ① 3-Way Socket ②

Lamp: E-27 Medium Base (Max. 60W ① 150W ②)

Features: 3-Way Switch ②

LS-23181 ③ · Cacto Table Lamp

Body: Gunmetal / Ceramic / Metal

Shade: Light Beige / Fabric

Switch: 3-Way Socket

Lamp: E-27 Medium Base (Max. 150W)

Features: 3-Way Switch, Fabric Top Diffuser

LS-23187 ④ · Bloom Table Lamp

Body: Chrome / Ceramic

Shade: White / Fabric

Switch: 3-Way Socket

Lamp: E-27 Medium Base (Max. 150W)

Features: 3-Way Switch, Fabric Top Diffuser

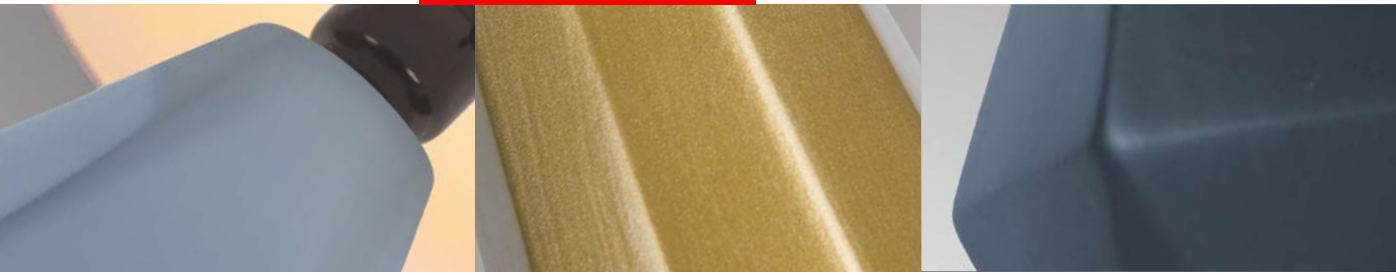

LS-23204BLU ① / GREY ② / JBLK ③ / ORN ④ / WHT ⑤

· Mason Table Lamp

Body: Blue, Grey, Jet Black, Orange or White / Ceramic

Shade: White / Fabric

Switch: On/Off Socket

Lamp: E-27 Medium Base (Max. 60W)

LS-23212GOLD ⑥ / JBLK ⑦ / SILV ⑧ / WHT ⑨

· Charna Table Lamp

Body: Gold, Jet Black, Silver or White / Ceramic

Shade: White / Fabric

Switch: On/Off Socket

Lamp: E-27 Medium Base (Max. 60W)

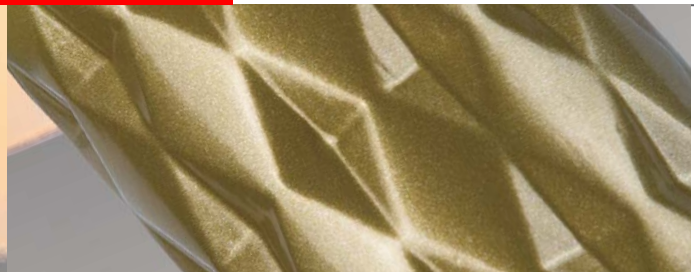
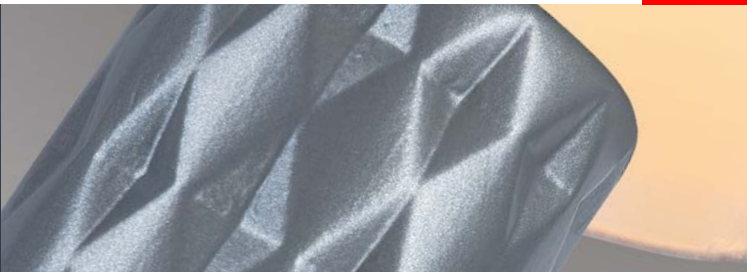

LS-23202GOLD ① / JBLK ② / SILV ③ / WHT ④
 · Delta Table Lamp
 Body: Gold, Jet Black, Silver or White / Ceramic
 Shade: White / Fabric
 Switch: On/Off Socket
 Lamp: E-27 Medium Base (Max. 60W)

LS-23203GOLD ⑤ / JBLK ⑥ / SILV ⑦ / WHT ⑧
 · Delta Table Lamp
 Body: Gold, Jet Black, Silver or White / Ceramic
 Shade: White / Fabric
 Switch: On/Off Socket
 Lamp: E-27 Medium Base (Max. 100W)

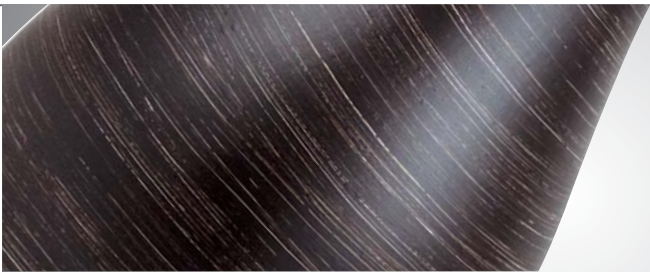

①

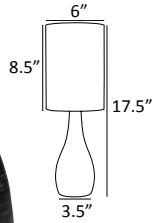

②

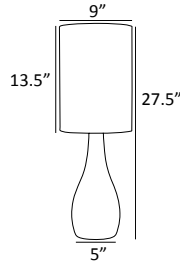

⑤



③

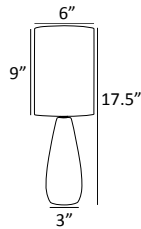

④

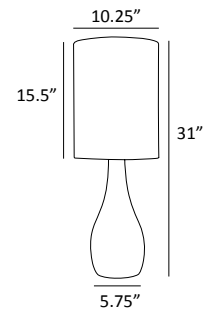
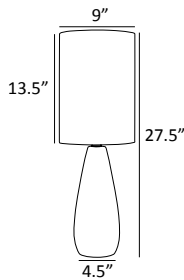

LS-2996 ① / 2997 ② / 2998 ③ / 2999 ④ / 22997 ⑤

· Quatro Table Lamp

Body: Brushed Dark Bronze / Ceramic

Shade: Linen / Fabric

Switch: On/Off Socket

Lamp: E-27 Medium Base (Max. 60W or 100W/LS-22997)

Introducing Quatro 2-Pack

LS-2996/2PK ①

LS-2997/2PK ②

LS-2998/2PK ③

LS-2999/2PK ④

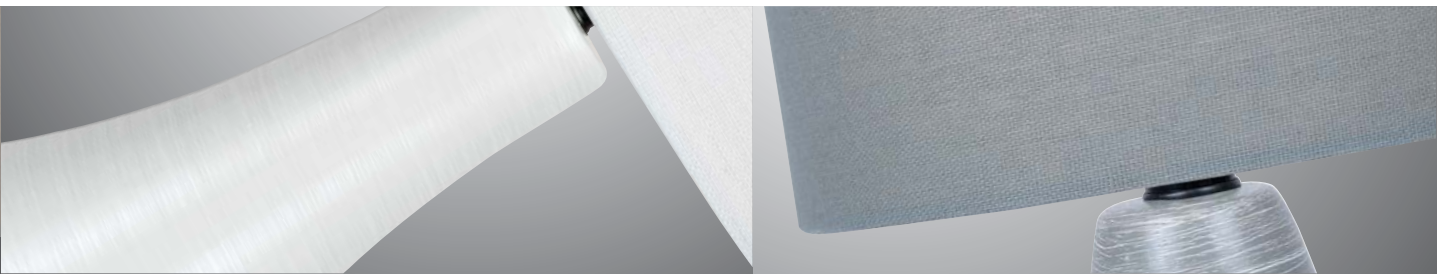

- | | | | |
|-------------------|-------------------|-------------------|---|
| LS-23998GRY/GRY ① | LS-23999GRY/GRY ⑤ | LS-24997GRY/GRY ⑨ | • Quatro Table Lamp |
| LS-23998GRY/WHT ② | LS-23999GRY/WHT ⑥ | LS-24997GRY/WHT ⑩ | Body: Brushed Grey or Brushed White / Ceramic |
| LS-23998WHT/GRY ③ | LS-23999WHT/GRY ⑦ | LS-24997WHT/GRY ⑪ | Shade: Grey or White Linen / Fabric |
| LS-23998WHT/WHT ④ | LS-23999WHT/WHT ⑧ | LS-24997WHT/WHT ⑫ | Switch: On/Off Socket |
| | | | Lamp: E-27 Medium Base |
| | | | (Max. 60W or 100W/LS-24997) |

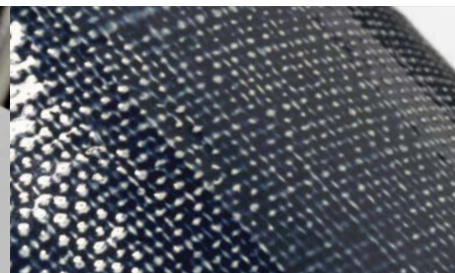
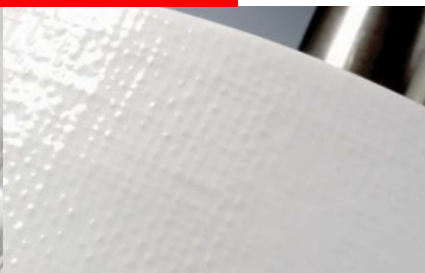

①



②

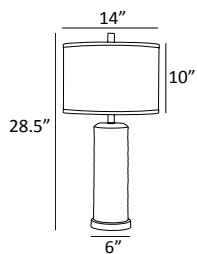

③



④

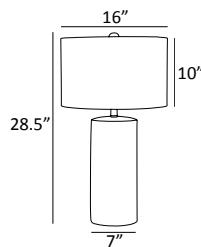

LS-23055BLU ①
LS-23055GREY ② · Hackett Table Lamp
Body: Blue or Light Grey / Ceramic
Shade: Linen / Fabric
Switch: On/Off Socket
Lamp: E-27 Medium Base (Max. 100W)
Features: **Acrylic Base**

LS-23063BLU ③
LS-23063WHT ④ · Jacoby Table Lamp
Body: Navy Blue or White / Ceramic
Shade: Grey Linen / Fabric
Switch: 3-Way Socket
Lamp: E-27 Medium Base (Max. 150W)
Features: **3-Way Switch**

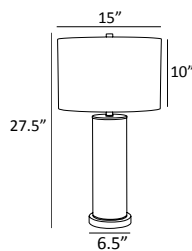
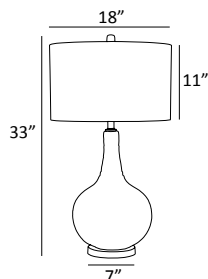

LS-23072GREY ①
LS-23072WHT ② · Dylan Table Lamp
 Body: Metallic Grey or Marble White / Glass
 Shade: Dark Grey or White / Fabric
 Switch: On/Off Socket
 Lamp: E-27 Medium Base (Max. 100W)

LS-23085GOLD ③
LS-23085WHT ④ · Gordon Table Lamp
 Body: Clear Glass / Gold or Silver Thread
 Shade: White / Fabric
 Switch: On/Off Socket
 Lamp: E-27 Medium Base (Max. 100W)



Scan For Video
Presentation



KELSTON
VALTINA
BASIR
ROGELIO
URBANO

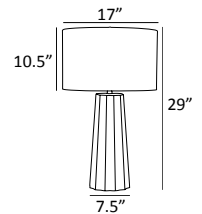
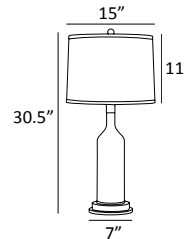
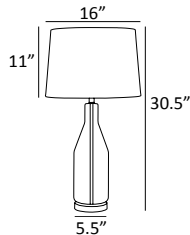
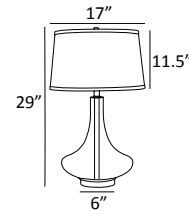
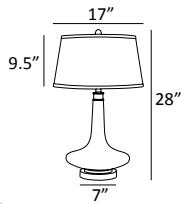

Scan For Video
Presentation

LS-22576 ① · Kelston Table Lamp

Body: Smoke Mirror Glass / Chrome Metal
Shade: Light Grey / Fabric
Switch: On/Off Socket
Lamp: E-27 Medium Base (Max. 100W)

LS-22856 ② · Valtina Table Lamp

Body: Clear or 2-Tone Glass / Chrome Metal
Shade: Off-White / Fabric
Switch: On/Off Socket
Lamp: E-27 Medium Base (Max. 100W)

LS-22880 ③ · Basir Table Lamp

Body: Clear Champagne Glass / Brushed Nickel Metal
Shade: Linen / Fabric
Switch: On/Off Socket
Lamp: E-27 Medium Base (Max. 100W)

LS-22881 ④ · Rogelio Table Lamp

Body: Clear Glass / Chrome Metal
Shade: Linen / Fabric
Switch: On/Off Socket
Lamp: E-27 Medium Base (Max. 100W)

LS-22890 ⑤ · Urbano Table Lamp

Body: Clear Light Amber Glass / Chrome Metal
Shade: Off-White / Fabric
Switch: On/Off Socket
Lamp: E-27 Medium Base (Max. 100W)

A D O R A
T W I L A
M A N D A L A Y
M E R C I A
M O D E S T O
S I L A S



①

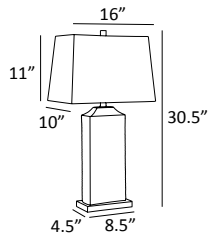

②

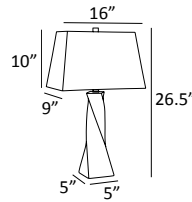

③

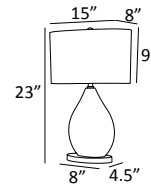

④

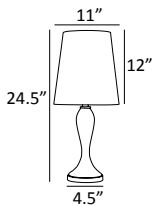

⑤

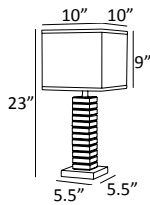

⑥

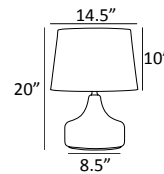

CONTEMPORARY

LS-22514C ① · Adora Table Lamp

Body: Chrome / Ceramic & Metal
Shade: Faux-Silk Silver / Fabric
Switch: On/Off Socket
Lamp: E-27 Medium Base (Max. 100W)

LS-22517C ② · Twila Table Lamp

Body: Chrome / Ceramic & Metal
Shade: Off-White / Fabric
Switch: On/Off Socket
Lamp: E-27 Medium Base (Max. 100W)

LS-22711 ③ · Mandalay Table Lamp

Body: Gold Mirror w. Speckles Glass / Chrome Metal
Shade: Champagne Elliptical / Fabric
Switch: On/Off Socket
Lamp: E-27 Medium Base (Max. 100W)

LS-22712 ④ · Mercia Table Lamp

Body: Chrome w. Speckles Glass / Chrome Metal
Shade: Silver Lurex / Fabric
Switch: On/Off In-Line
Lamp: E-27 Medium Base (Max. 60W)

LS-22749 ⑤ · Modesto Table Lamp

Body: Clear Acrylic / Chrome Metal
Shade: Off-White / Fabric
Switch: On/Off Socket
Lamp: E-27 Medium Base (Max. 100W)

LS-22872 ⑥ · Silas Table Lamp

Body: Chrome w. Sparckles / Glass
Shade: Linen / Fabric
Switch: On/Off Socket
Lamp: E-27 Medium Base (Max. 60W)

EMILLIE
ENRICO
GODIVO
RENATE
ALAGAN



①

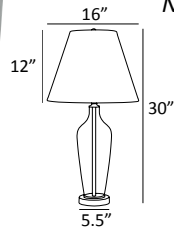

Night Light →



②

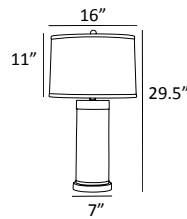

③

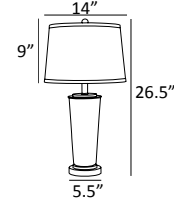

④

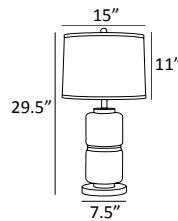

⑤

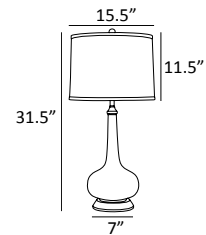

LS-22443 ① · Emillie Table Lamp

Body: Clear Glass / Chrome Metal
Shade: Off-White / Fabric
Switch: On/Off Socket
Lamp: E-27 Medium Base (Max. 100W)

LS-22816 ④ · Renate Table Lamp

Body: Clear Glass / Chrome Metal
Shade: Off-White / Fabric
Switch: On/Off Socket
Lamp: E-27 Medium Base (Max. 100W)

LS-22446 ② · Enrico Table Lamp

Body: Clear Glass / Satin Nickel Metal
Shade: Off-White / Fabric
Switch: 3-Way Socket
Main Lamp: E-27 Medium Base (Max. 100W)
Nightlight: 2W LED
Features: **LED Nightlight, 3-Way Switch**

LS-22815 ③ · Godivo Table Lamp

Body: Clear Glass / Brushed Nickel Metal
Shade: Off-White / Fabric
Switch: On/Off Socket
Lamp: E-27 Medium Base (Max. 100W)

LS-22891 ⑤ · Alagan Table Lamp

Body: Clear Glass / Brushed Nickel Metal
Shade: Linen / Fabric
Switch: On/Off Socket
Lamp: E-27 Medium Base (Max. 100W)

FUNKTIONS
A X I S
CONTENTO
JAYMES
F I C O
U L R I C

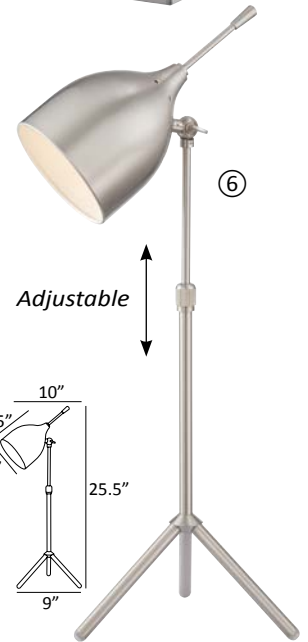
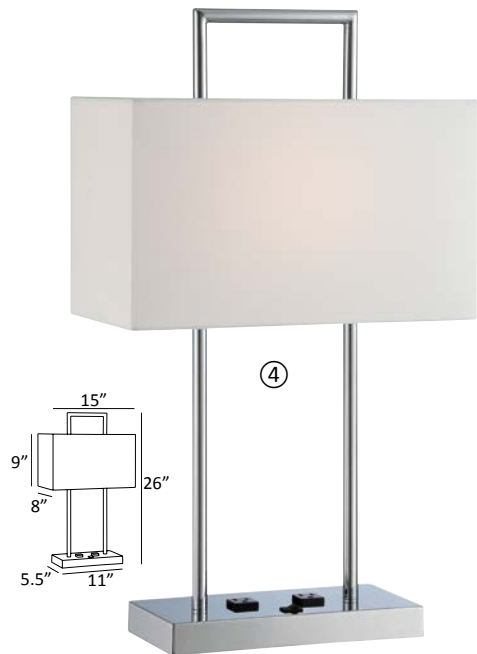
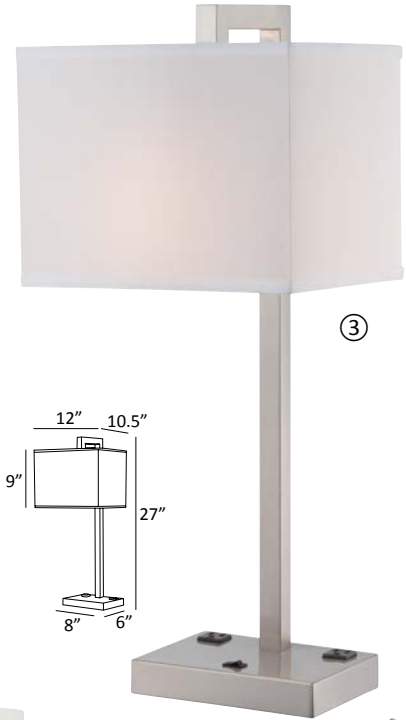
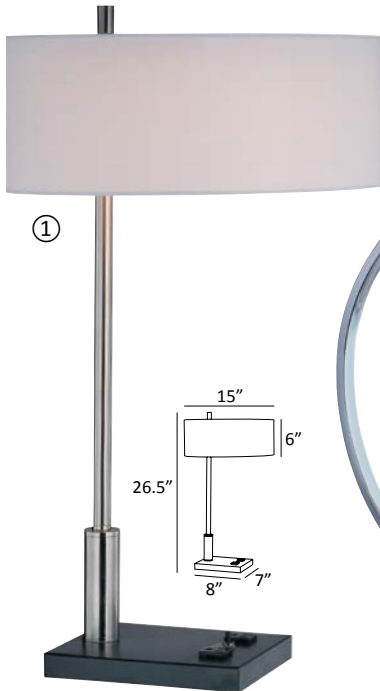

CONTEMPORARY

LS-21396 ① · Funktions Table Lamp

Body: Brushed Nickel & Black / Metal
Shade: Off-White / Fabric
Switch: On/Off Push-Button on Base
Lamp: E-27 Medium Base (Max. 60W)
Features: **Electrical Outlet x2**

LS-21652 ② · Axis Table Lamp

Body: Chrome / Metal
Shade: Off-White w. Top Diffuser / Fabric
Switch: On/Off In-Line
Lamp: E-27 Medium Base (Max. 60W)
Features: **Adjustable Shade**

LS-22283 ③ · Contento Table Lamp

Body: Satin Nickel / Metal
Shade: Off-White / Fabric
Switch: On/Off Rocker on Base
Lamp: E-27 Medium Base (Max. 100W)
Features: **Electrical Outlet x2**

LS-22473 ④ · Jaymes Table Lamp

Body: Chrome / Metal
Shade: Off-White / Fabric
Switch: On/Off Rocker on Base
Lamp: E-27 Medium Base (Max. 100W)
Features: **Electrical Outlet x2**

LS-22525G ⑤ · Fico Table Lamp

Body: Gun Metal / Clear Crystal
Shade: Off-White / Fabric
Switch: On/Off Rocker on Base
Lamp: E-27 Medium Base (Max. 100W)
Features: **Electrical Outlet x1**

LS-22808PS ⑥ · Ulric Table Lamp

Body: Polished Steel / Metal
Shade: Polished Steel / Metal
Switch: On/Off In-Line
Lamp: E-27 Medium Base (Max. 60W)
Features: **Adjustable Height & Shade**

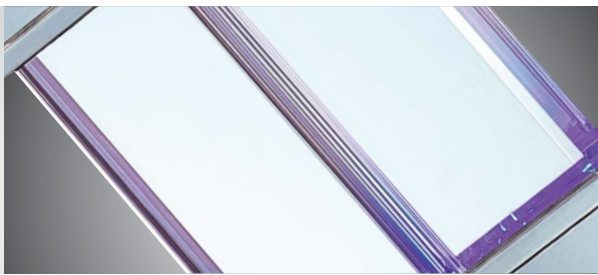
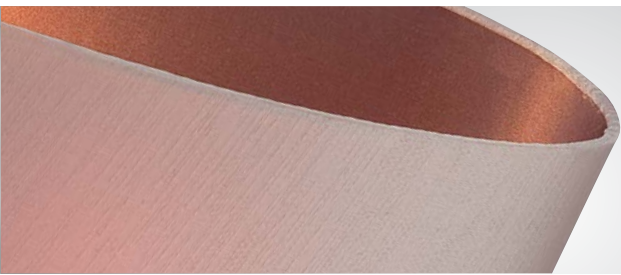

FIDELIO
J E D I
B L I S S
T I T U S
L U C E T T A



①

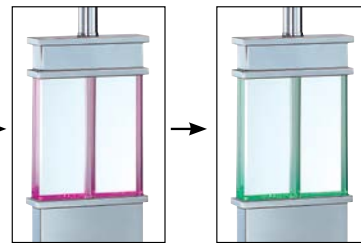

②

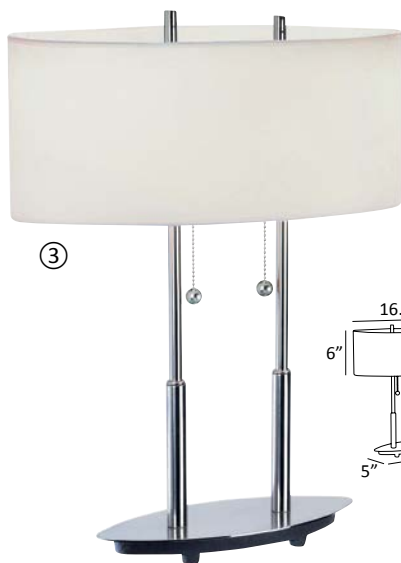
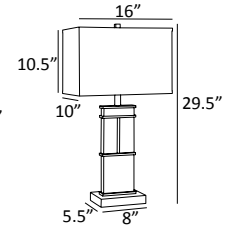
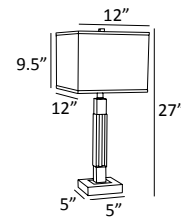

③

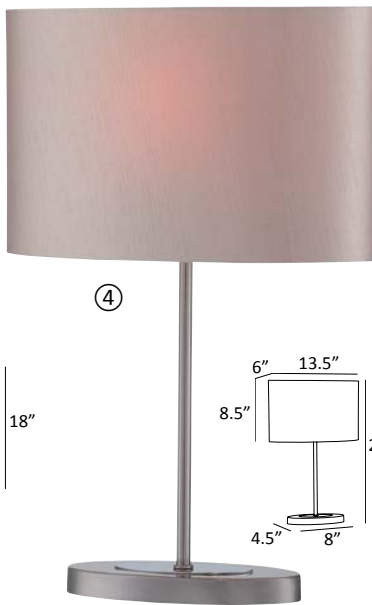
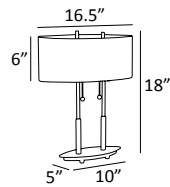

④

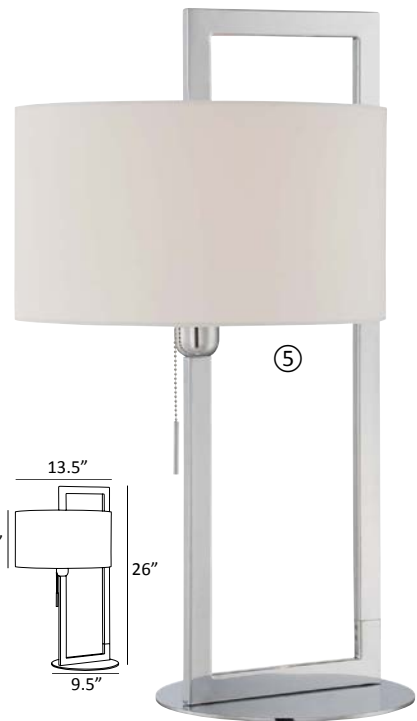
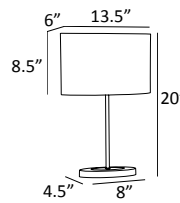

⑤

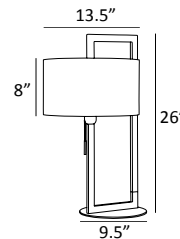

LS-21826 ① · Fidelio Table Lamp
LS-21892 ② · Jedi Table Lamp

Body: Chrome / Metal
Shade: Off-White / Fabric
Switch: 3-Way Socket
Main Lamp: E-27 Medium Base (Max. 100W)
Nightlight: RGB LED Panel
Features: **3-Way Switch, Nightlight w. RGB Color-Shifting**

LS-3821PS/WHT ③ · Bliss Table Lamp

Body: Chrome / Metal
Shade: Off-White Elliptical / Fabric
Switch: Dual Pull-Chain
Lamp: E-27 Medium Base (Max. 60W) x2

LS-22717 ④ · Titus Table Lamp

Body: Gun Metal / Metal
Shade: Champagne Tone Elliptical / Fabric
Switch: On/Off Socket
Lamp: E-27 Medium Base (Max. 60W)

LS-22630 ⑤ · Lucetta Table Lamp

Body: Chrome / Metal
Shade: Off-White w. Top Diffuser / Fabric
Switch: On/Off Pull-Chain
Lamp: E-27 Medium Base (Max. 60W)



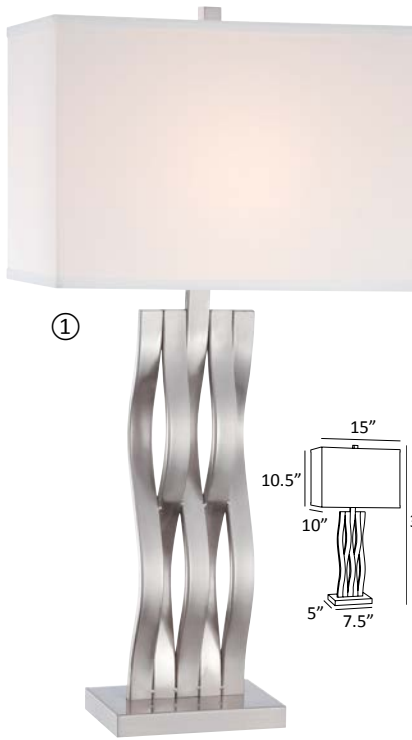

①

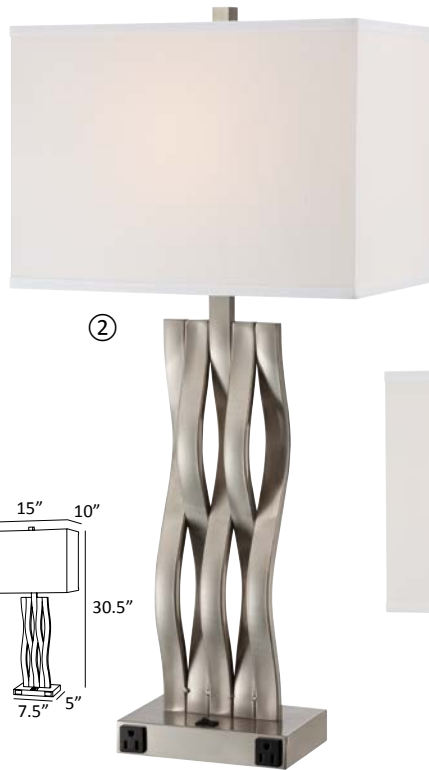

②



③



④



⑤

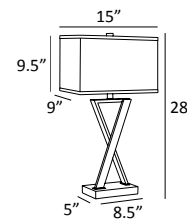
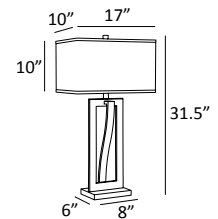

LS-22075 ① · Hamo Table Lamp

Body: Brushed Nickel / Metal
Shade: Off-White / Fabric
Switch: 3-Way Socket
Lamp: E-27 Medium Base (Max. 150W)
Features: **3-Way Switch**

LS-22075OTL ② · Hamo II Table Lamp

Body: Brushed Nickel / Metal
Shade: Off-White / Fabric
Switch: On/Off Rocker on Base
Lamp: E-27 Medium Base (Max. 100W)
Features: **Electrical Outlet x2**

LS-22570 ③ · Finley Table Lamp

Body: Brushed Nickel & Gun Metal
Shade: Off-White / Fabric
Switch: 3-Way Rotary on Base
Lamp: E-27 Medium Base (Max. 150W)
Features: **3-Way Switch**

LS-22453 ④ · Frasco Table Lamp

Body: Satin Nickel / Metal
Shade: Off-White / Fabric
Switch: On/Off In-Line
Lamp: E-27 Medium Base (Max. 100W)

LS-22571 ⑤ · Alexis Table Lamp

Body: Chrome / Metal
Shade: Off-White / Fabric
Switch: On/Off Socket
Lamp: E-27 Medium Base (Max. 100W)

SHEENA
ODELE
CAILEAN
CELESTINE
CATRIONA
MABON

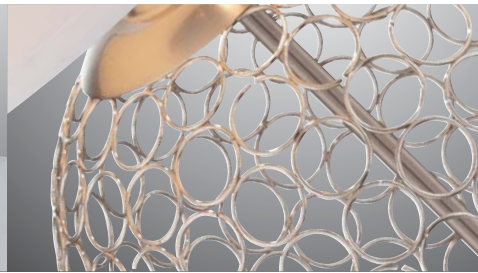
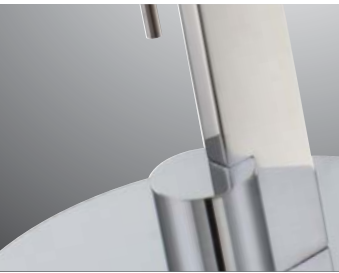

①

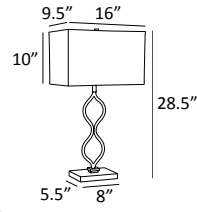

②

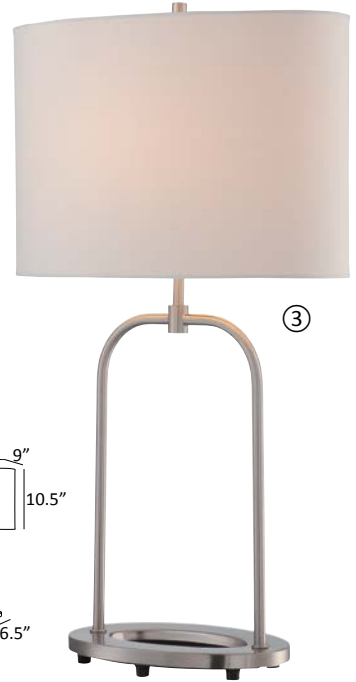
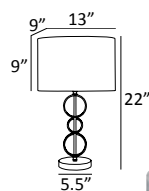

③

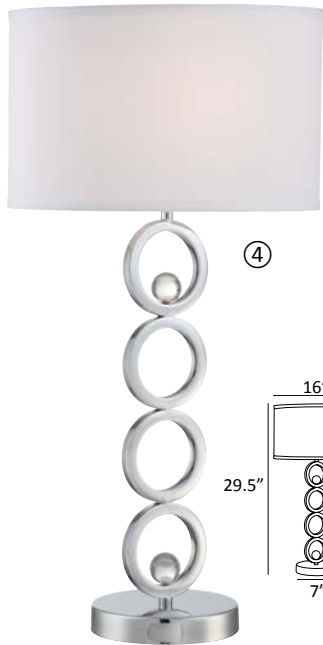
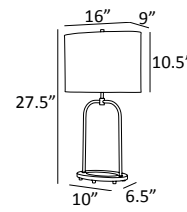

④

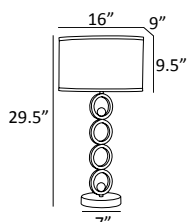

⑤

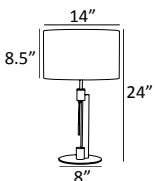

⑥

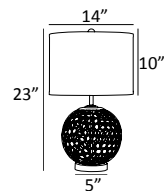

LS-22386 ① · Sheena Table Lamp

Body: Chrome / Metal
Shade: Off-White / Fabric
Switch: On/Off Socket
Lamp: E-27 Medium Base (Max. 100W)

LS-22620 ② · Odele Table Lamp

Body: Satin Nickel / Metal
Shade: Off-White Elliptical / Fabric
Switch: On/Off Socket
Lamp: E-27 Medium Base (Max. 60W)

LS-22665 ③ · Cailean Table Lamp

Body: Brushed Nickel / Metal
Shade: Off-White Elliptical / Fabric
Switch: On/Off Socket
Lamp: E-27 Medium Base (Max. 100W)

LS-22700 ④ · Celestine Table Lamp

Body: Chrome Metal / Clear Crystal
Shade: Off-White / Fabric
Switch: On/Off Socket
Lamp: E-27 Medium Base (Max. 100W)
Features: **Crystal Deco.**

LS-22735 ⑤ · Catriona Table Lamp

Body: Chrome / Metal
Shade: Off-White / Fabric
Switch: On/Off Pull-Chain
Lamp: E-27 Medium Base (Max. 60W)

LS-22899 ⑥ · Mabon Table Lamp

Body: Brushed Nickel / Metal
Shade: Off-White / Fabric
Switch: On/Off Socket
Lamp: E-27 Medium Base (Max. 100W)



①

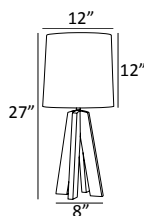

②



③

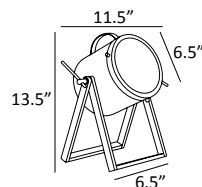

④



⑤

LS-22887CHARC ①
 LS-22887WHT ② · Kitoko Table Lamp
 Body: Charcoal or White Wood
 Shade: Linen / Fabric
 Switch: On/Off Socket
 Lamp: E-27 Medium Base (Max. 100W)

LS-23095BLK ③ / LS-23095GREY ④ / LS-23095WHT ⑤
 · Sully Accent Lamp
 Stand: Natural / Wood
 Shade: Black & Antique Brass, Grey & Brushed Nickel or White & Chrome / Metal
 Diffuser: Frosted / Glass
 Switch: On/Off In-Line
 Lamp: E-27 Medium Base (Max. 60W)
 Features: **Adjustable Stand & Shade, Pick-up Handle**

DIANDRA
KENNETH
ROBENA
RACHELLE
LUNETTE

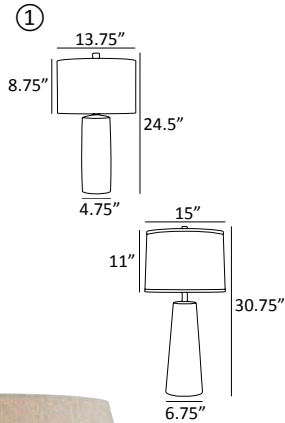
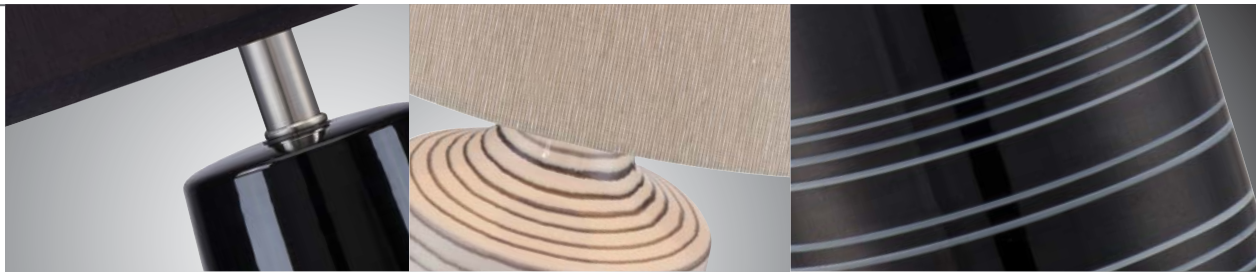

②



③

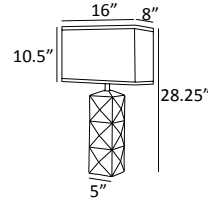

⑤

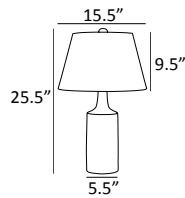

⑥

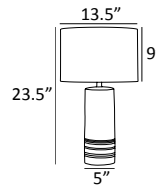

④

CONTEMPORARY

LS-21979WHT ① · Diandra Table Lamp

Body: White / Ceramic
Shade: White / Fabric
Switch: On/Off Socket
Lamp: E-27 Medium Base (Max. 100W)

LS-22130BLK/BLK ② · Kenneth Table Lamp

Body: Black / Ceramic
Shade: Black / Fabric
Switch: On/Off Socket
Lamp: E-27 Medium Base (Max. 100W)

LS-22239BLK ③

LS-22239WHT ④ · Robena Table Lamp

Body: Black or White / Ceramic
Shade: Matching Color / Fabric
Switch: 3-Way Socket
Lamp: E-27 Medium Base (Max. 150W)
Features: **3-Way Switch**

LS-22877 ⑤ · Rachelle Table Lamp

Body: White & Black / Ceramic
Shade: Light Beige / Fabric
Switch: On/Off Socket
Lamp: E-27 Medium Base (Max. 100W)

LS-22885 ⑥ · Lunette Table Lamp

Body: Black & White / Ceramic
Shade: White w. Top Diffuser / Fabric
Switch: On/Off Socket
Lamp: E-27 Medium Base (Max. 100W)



①

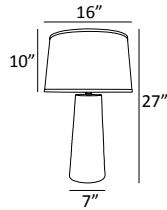

②

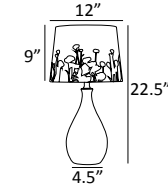

③



④

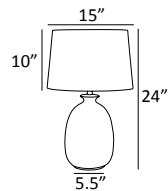

⑤

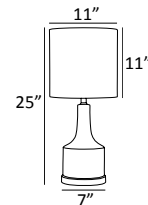

⑥

LS-20830ORN ① · Ashanti Table Lamp

Body: Ivory or Orange / Ceramic
Shade: Matching Color / Fabric
Switch: 3-Way Socket
Lamp: E-27 Medium Base (Max. 150W)
Features: **3-Way Switch**

LS-21489GRN ②

LS-21489ORN ③ · Edaline Table Lamp

Body: Green or Orange / Ceramic
Shade: Beige & Floral Sihollette / Fabric
Switch: On/Off Socket
Lamp: E-27 Medium Base (Max. 60W)

LS-22883H/YLW ④

LS-22883JADE ⑤ · Valora Table Lamp

Body: Harvest Yellow or Jade / Ceramic
Shade: Linen / Fabric
Switch: On/Off Socket
Lamp: E-27 Medium Base (Max. 100W)

LS-22944 ⑥ · Ruana Table Lamp

Body: Ivory Ceramic / Chrome Metal
Shade: Linen / Fabric
Switch: On/Off Socket
Lamp: E-27 Medium Base (Max. 100W)

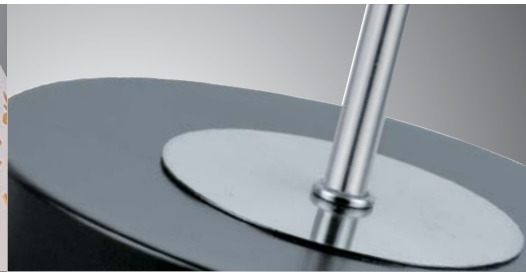
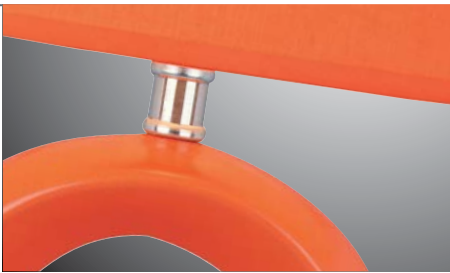

①



②



③

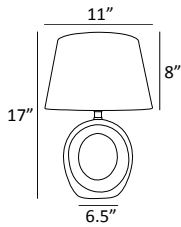

④



⑤



⑥

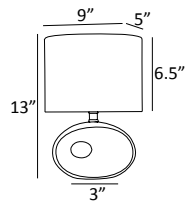

LS-20585ORN ① · Viko Accent/Table Lamp

Body: Blue, Green, Orange or Red / Ceramic
 Shade: Matching Color / Fabric
 Switch: On/Off Socket
 Lamp: E-27 Medium Base (Max. 60W)

LS-22315L/BLU ②

LS-22315L/GRN ③

LS-22315LAV ④

LS-22315ORN ⑤

LS-22315PINK ⑥

· Hennessy II Accent/Table Lamp

Body: Light Blue, Light Green, Lavender, Orange or Pink / Ceramic
 Shade: Matching Color Elliptical / Fabric
 Switch: On/Off In-Line
 Lamp: E-27 Medium Base (Max. 60W)



LS-21797C/BLK ①

LS-21797C/BLU ②

LS-21797C/GRN ③

LS-21797C/ORN ④

LS-21797C/WHT ⑤

· Levon Accent/Table Lamp

Body: Chrome / Metal

Shade: Black, Blue, Green, Orange or White / Fabric

Switch: On/Off In-Line

Lamp: E-12 Candelabra Base (Max. 40W)

LS-22960BLU ⑥

LS-22960ORN ⑦

LS-22960PURP ⑧

LS-22960SMOKE ⑨

LS-22960WHT ⑩

· Jamie Accent/Table Lamp

Body: Blue, Orange, Purple, Smoke or Clear / Glass

Shade: Matching Color / Fabric

Switch: On/Off Socket

Lamp: E-27 Medium Base (Max. 60W)

PASS-ME
PITCH-ME
KICK-ME
TWINKLE
DECKER
POPPY

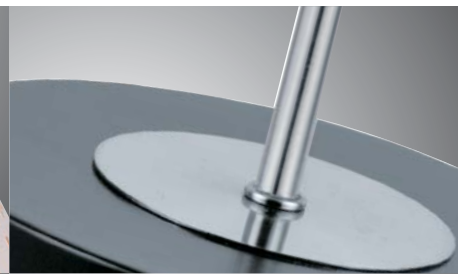
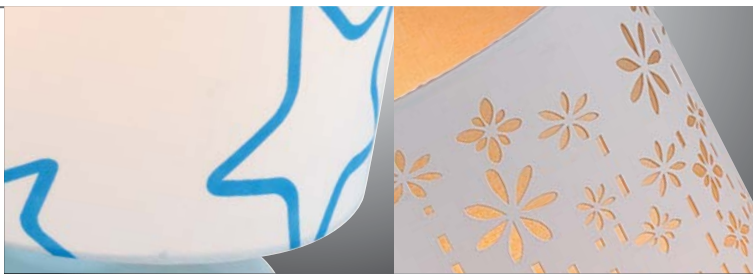

①

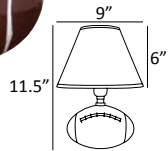

②

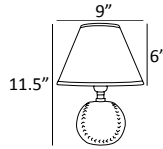

③

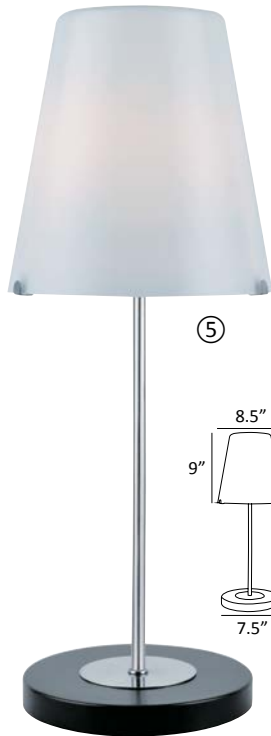
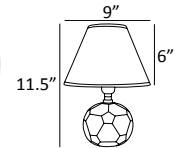

④

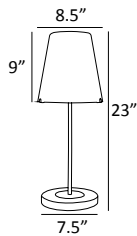

⑤

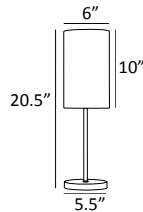

⑥



⑦

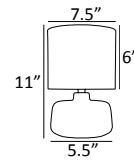

CONTEMPORARY

IK-6100 ① · "Pass-Me" Accent Lamp

Body: Football Sculpture / Ceramic
Shade: White & Brown Trim / Fabric
Switch: On/Off Socket
Lamp: E-27 Medium Base (Max. 40W)

IK-6101 ② · "Pitch-Me" Accent Lamp

Body: Baseball Sculpture / Ceramic
Shade: White & Red Trim / Fabric
Switch: On/Off Socket
Lamp: E-27 Medium Base (Max. 40W)

IK-6102 ③ · "Kick-Me" Accent Lamp

Body: Soccer Ball Sculpture / Ceramic
Shade: White & Black Trim / Fabric
Switch: On/Off Socket
Lamp: E-27 Medium Base (Max. 40W)

IK-6105L/BLU ④ · "Twinkle" Accent Lamp

Body: Light Blue / Ceramic
Shade: White & Light Blue Star Prints / Fabric
Switch: On/Off In-Line
Lamp: E-27 Medium Base (Max. 60W)

LS-21910 ⑤ · Decker Table Lamp

Body: Brushed Nickel & Black / Metal
Shade: Frosted / Glass
Switch: On/Off In-Line
Lamp: E-27 Medium Base (Max. 60W)

LS-22720GOLD ⑥

Body: Chrome / Metal
Shade: Off-White Fabric / Gold or Red Cut-Out Liner
Switch: On/Off In-Line
Lamp: E-27 Medium Base (Max. 60W)

LS-22720RED ⑦ · Poppy Table Lamp



PEPITA
REIKO
PIERA
KARA



①

*Night Light
Through Glass*

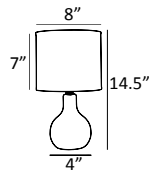

②

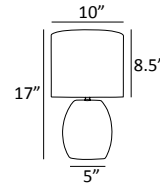

③



④

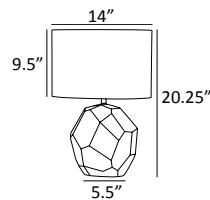

⑤

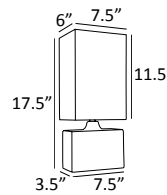

⑥

LS-20073AQUA ① · Pepita Table Lamp

Body: Marbleized Aqua / Glass
Shade: Off-White / Fabric
Switch: 3-Way Socket
Main Lamp: E-27 Medium Base (Max. 40W)
Nightlight: E-12 Candelabra Base (Max. 7W)
Features: **Nightlight**

LS-21983C ④ · Piera Table Lamp

Body: Chrome / Ceramic
Shade: White Elliptical / Fabric
Switch: On/Off In-Line
Lamp: E-27 Medium Base (Max. 60W)

LS-21506BLK ②

LS-21506ORN ③ · Reiko Accent/Table Lamp

Body: Black, Latte or Orange / Ceramic
Shade: Printed Pattern / Fabric
Switch: On/Off In-Line
Lamp: E-27 Medium Base (Max. 60W)

LS-22378AQUA ⑤

LS-22378ORN ⑥ · Kara Accent/Table Lamp
Body: Aqua Blue or Orange / Ceramic
Shade: Off-White / Fabric
Switch: On/Off In-Line
Lamp: E-27 Medium Base (Max. 60W)

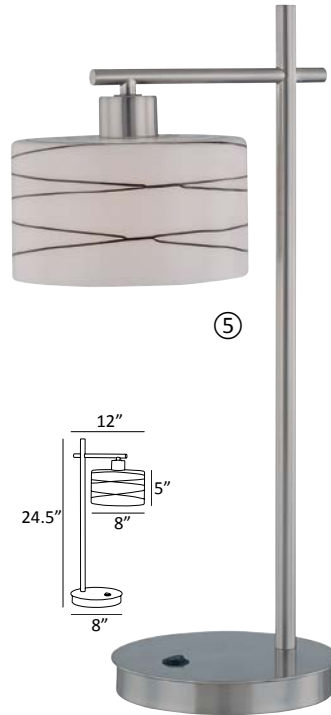
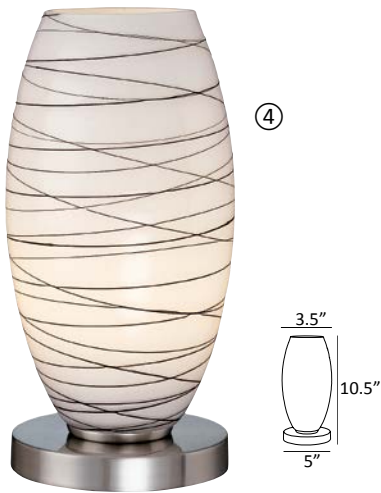
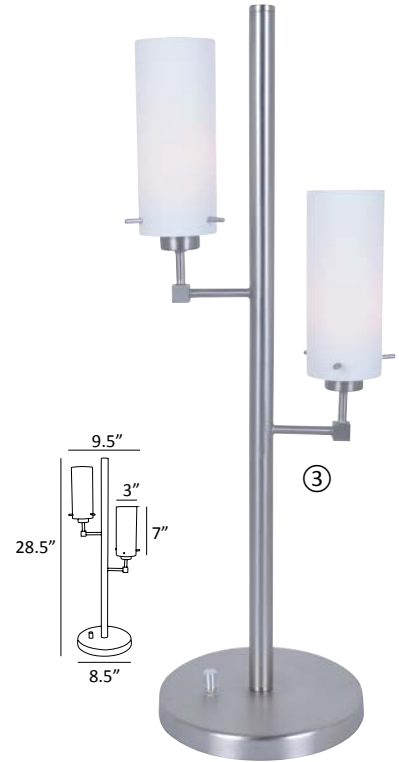
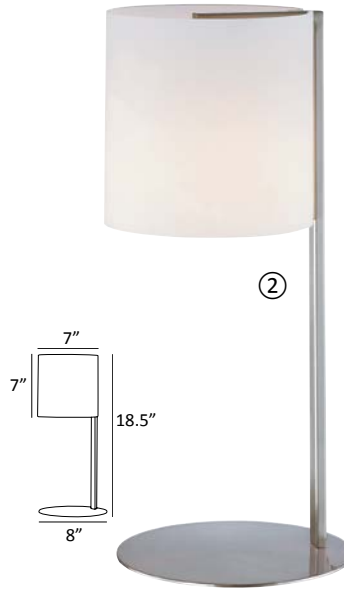
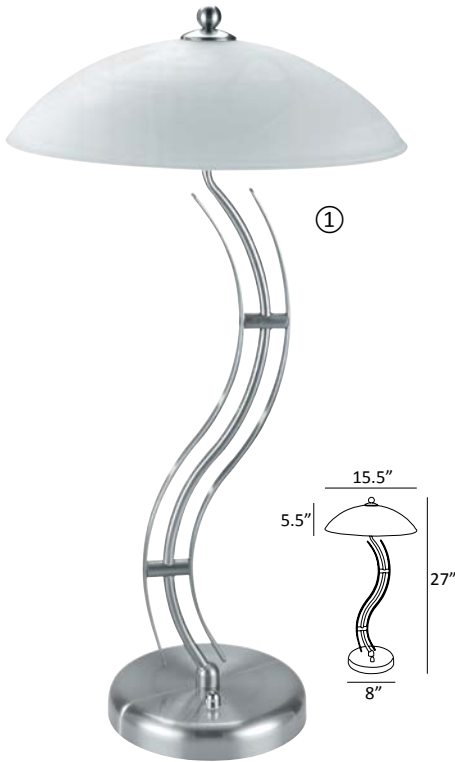

LS-2318PS/CLD ① · Curvy Table Lamp

Body: Polished Steel / Metal
Shade: Cloud / Glass
Switch: Dimmer on Base
Lamp: E-12 Candelabra Base (Max. 60W) x2
Features: **Dimmer Switch**

LS-20855 ④ · Giacomo Table Lamp

Base: Brushed Nickel / Metal
Shade: Frosted w. Glazed Black Lines / Glass
Switch: On/Off In-Line
Lamp: E-27 Medium Base (Max. 60W)

LS-20844PS/FRO ② · Velia Table Lamp

Body: Polished Steel / Metal
Shade: Cylindrical Frosted / Glass
Switch: On/Off In-Line
Lamp: E-27 Medium Base (Max. 60W)

LS-21513 ⑤ · Lenza Table Lamp

Body: Brushed Nickel / Metal
Shade: Frosted w. Glazed Black Lines / Glass
Switch: On/Off Rocker on Base
Lamp: E-27 Medium Base (Max. 60W)

LS-22755 ③ · Scarlett Table Lamp

Body: Polished Steel / Metal
Shade: Frosted / Glass
Switch: 3-Way Rotary on Base
Lamp: E-27 Medium Base (Max. 60W) x2
Features: **3-Way Switch**

LS-22942 ⑥ · Vogue Mirror Lamp

Body: Brushed Nickel Metal / Pleated Clear Glass
Shade: Brushed Nickel Metal / Frosted Glass Diffuser
Switch: On/Off Rotary on Base
Lamp: E-12 Candelabra Bulbs (Max. 7W) x8
Features: **Makeup & Magnifying Mirror**



Z E T T
G E M M A
C A I R O
L O R R A I N E

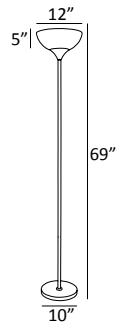
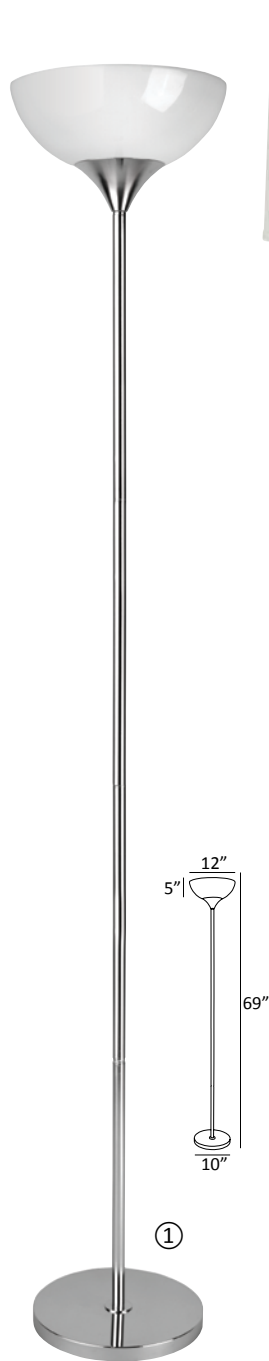

①

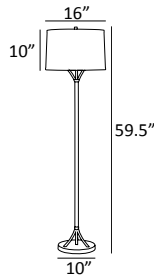
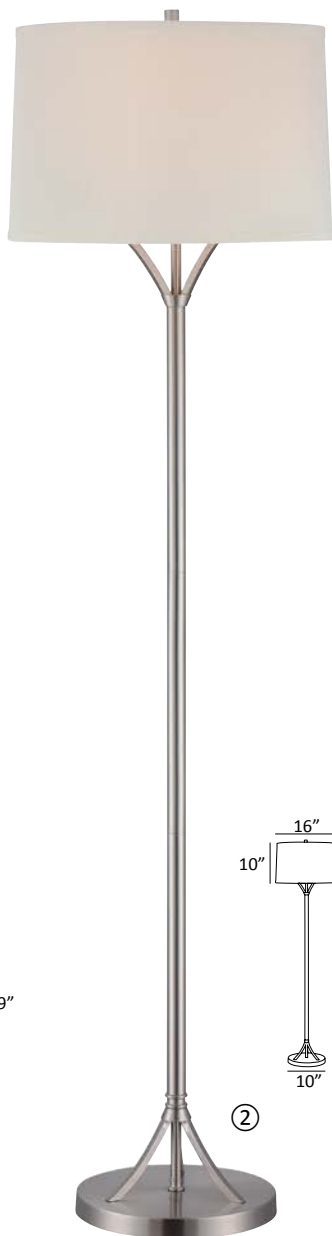

②

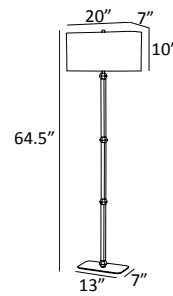

③

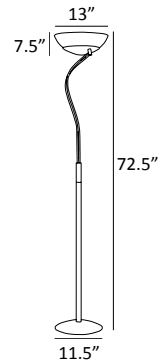
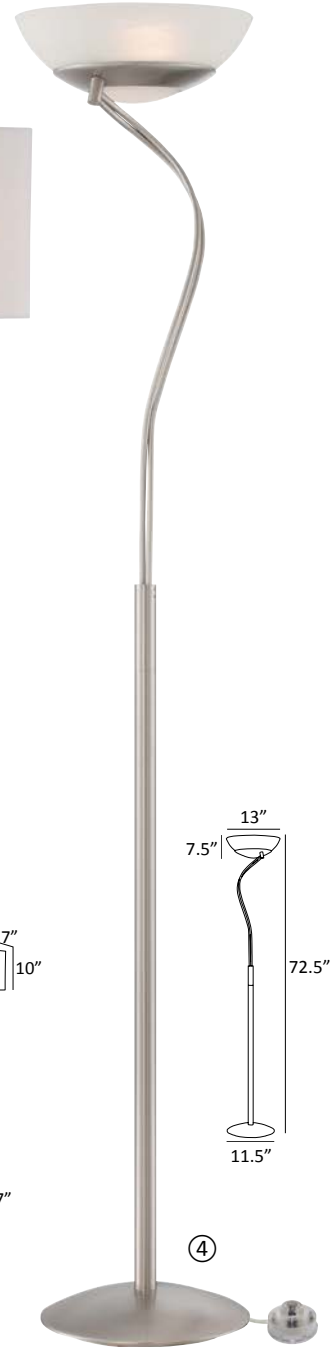

④

LS-8540C/WHT ① · Zett Torchiere Lamp

Body: Black, Chrome or White / Metal
Shade: White / Acrylic
Switch: On/Off Socket
Lamp: E-27 Medium Base (Max. 100W)

LS-81990PS/WHT ② · Gemma Floor Lamp

Body: Polished Steel / Metal
Shade: Off-White / Fabric
Switch: On/Off Socket
Lamp: E-27 Medium Base (Max. 100W)

LS-82628 ③ · Cairo Floor Lamp

Body: Chrome Metal / Clear Crystal
Shade: Off-White & Top Diffuser / Fabric
Switch: On/Off Foot
Lamp: E-27 Medium Base (Max. 60W) x2
Features: **Crystal Accents**

LS-82732 ④ · Lorraine Torchiere Lamp

Body: Brushed Nickel / Metal
Shade: Cloud / Glass
Switch: On/Off Foot
Lamp: E-27 Medium Base (Max. 100W) x2

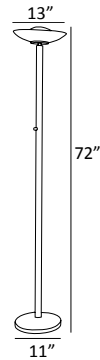
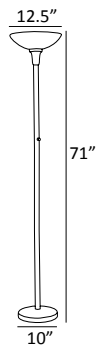
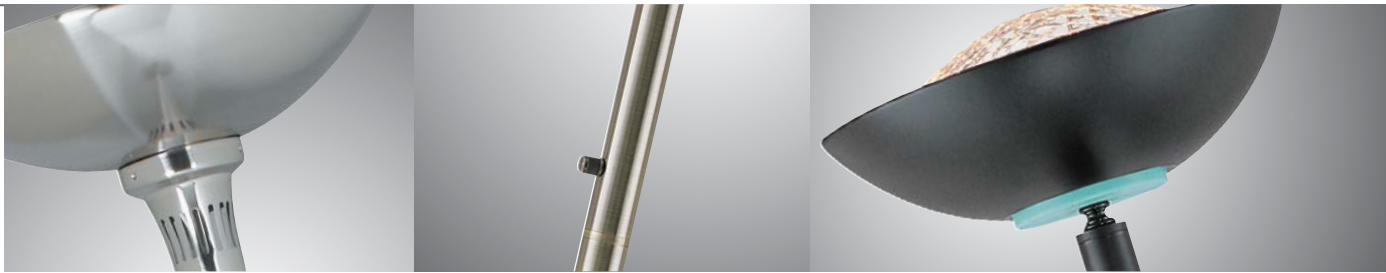

LS-9913BLK ①

LS-9913PS ②

· Servo Torchiere Lamp

Body: Black or Polished Steel / Metal

Shade: Matching Finish / Metal

Switch: On/Off Rotary on Pole

Lamp: E-27 Medium Base (Max. 100W) x2

LS-80910AB ③

LS-80910BLK ④

LS-80910PS ⑤

· Basic II Torchiere Lamp

Body: Antique Brass, Black or Polished Steel / Metal

Shade: Matching Finish Metal / Frosted Diffuser

Switch: Dimmer Rotary Switch on Pole

Lamp: J/180mm Halogen (Max. 180W)

Features: Halogen Bulb Included, Dimmable, Circuit Breaker Included



LS-9709PS/FRO ① · Lucien Torchiere/Reading Lamp

Body: Polished Steel / Metal
 Shade: Frosted / Glass
 Switch: Dual Dimmer Rotary Switches on Pole
 Main Lamp: E-27 Medium Base (Max. 100W) x2
 Reading Lamp: 12V JC/G5.35 Halogen (Max. 50W)
 Features: **Halogen Bulb Included, Adjustable Reading Lamp, Dual Dimmer Switches**

LS-81699BLK/FRO ②

LS-81699PS/FRO ③ · Avington Torchiere/Reading Lamp

Body: Black or Polished Steel / Metal
 Shade: Frosted Cloud / Glass
 Switch: 3-Way Rotary Switch on Pole
 Main Lamp: E-27 Medium Base (Max. 100W) x2
 Reading Lamp: 120V JCD/G9 Halogen (Max. 35W)
 Features: **Halogen Bulb Included, Adjustable Reading Lamp, 3-Way Switch**





LS-23076 ① · Theoris Table Lamp

Body: Dark Walnut Resin / Chrome Metal
 Shade: White / Fabric
 Switch: 3-Way Socket
 Main Lamp: E-27 Medium Base (Max. 100W)
 Nightlight: 3W LED Panel (3000K, 240lm, CRI: 80)
 Features: **LED Nightlight**

LS-83076 ② · Theoris Floor Lamp

Body: Dark Walnut Resin / Chrome Metal
 Shade: White / Fabric
 Switch: 3-Way Socket
 Main Lamp: E-27 Medium Base (Max. 100W)
 Nightlight: 3W LED Panel (3000K, 240lm, CRI: 80)
 Features: **LED Nightlight**

LS-83078 ③ · Theoris Arc Floor Lamp

Body: Dark Walnut Resin / Chrome Metal
 Shade: White / Fabric
 Switch: On/Off Rotary on Pole
 Main Lamp: E-27 Medium Base (Max. 100W)

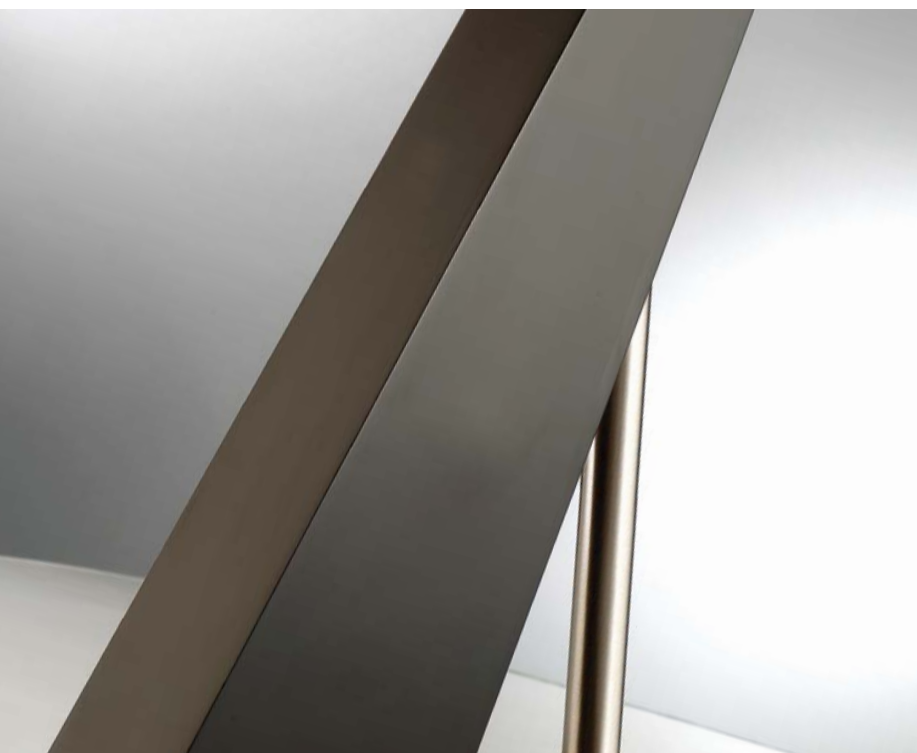



LS-21788 ① · Estella Table Lamp
 Body: Espresso Wood / Brushed Nickel Metal
 Shade: Off-White / Fabric
 Switch: On/Off Socket
 Bulb Base: E-27 Medium Base (Max. 100W)

LS-23077 ② · Viggo Table Lamp
 Body: Black Wood / Brushed Nickel / Metal
 Shade: Off-White / Fabric
 Switch: On/Off Socket
 Bulb Base: E-27 Medium Base (Max. 100W)

LS-81789 ③ · Estella Arc Floor Lamp
 Body: Espresso Wood / Brushed Nickel Metal
 Shade: Off-White / Fabric
 Switch: On/Off Rotary on Pole
 Main Lamp: E-27 Medium Base (Max. 100W)
 Features: **Marble Base**

TREMONT

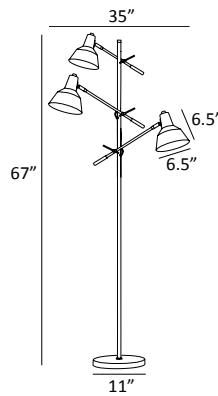
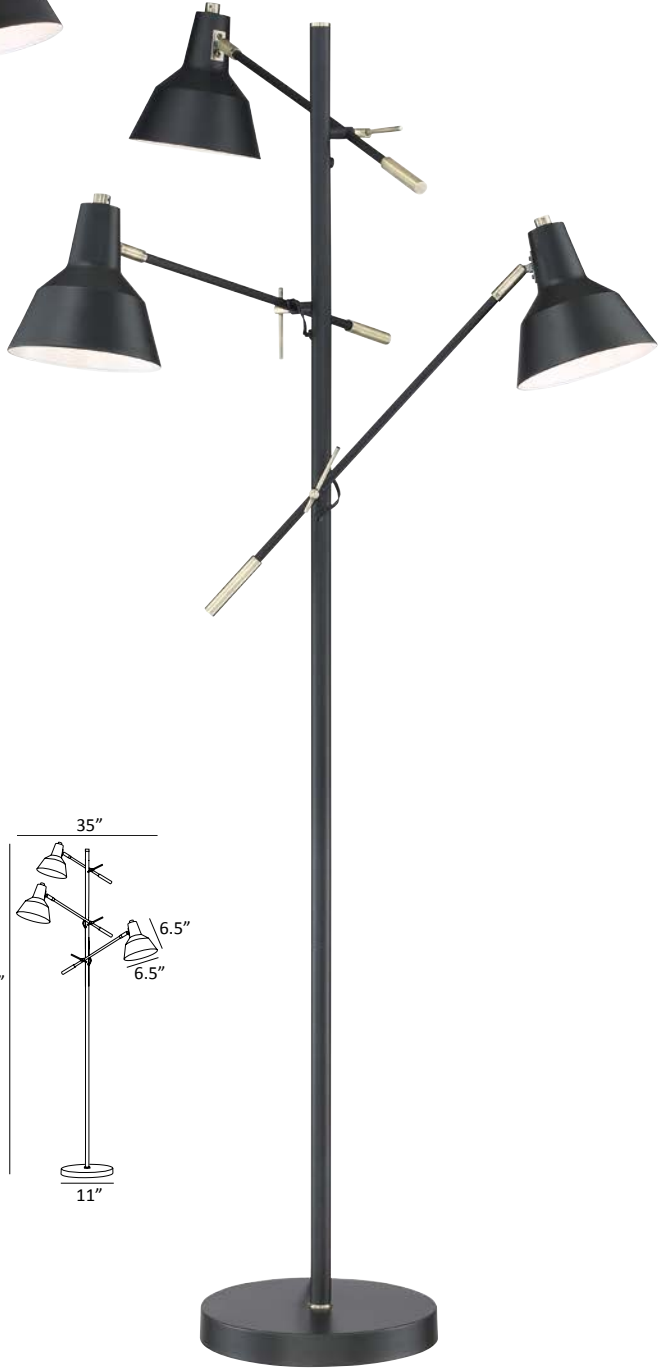
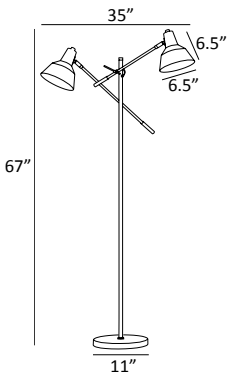
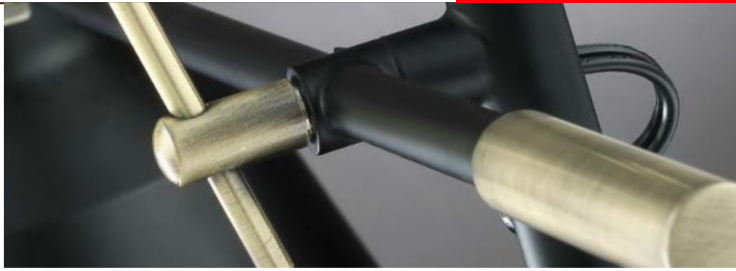

LS-83102 · Tremont 2-Lite Floor Lamp

Body: Black & Antique Brass / Metal
 Shade: Black / Metal
 Switch: On/Off Rotary on Shade
 Lamp: E-27 Medium Base (Max. 60W) x2
 Features: **Adjustable Arms & Shades**

LS-83103 · Tremont 3-Lite Floor Lamp

Body: Black & Antique Brass / Metal
 Shade: Black / Metal
 Switch: On/Off Rotary on Shade
 Lamp: E-27 Medium Base (Max. 60W) x3
 Features: **Adjustable Arms & Shades**

TRANSITIONAL

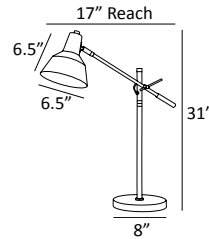
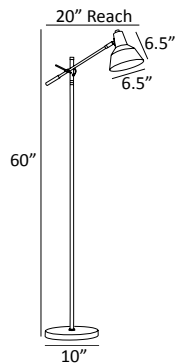
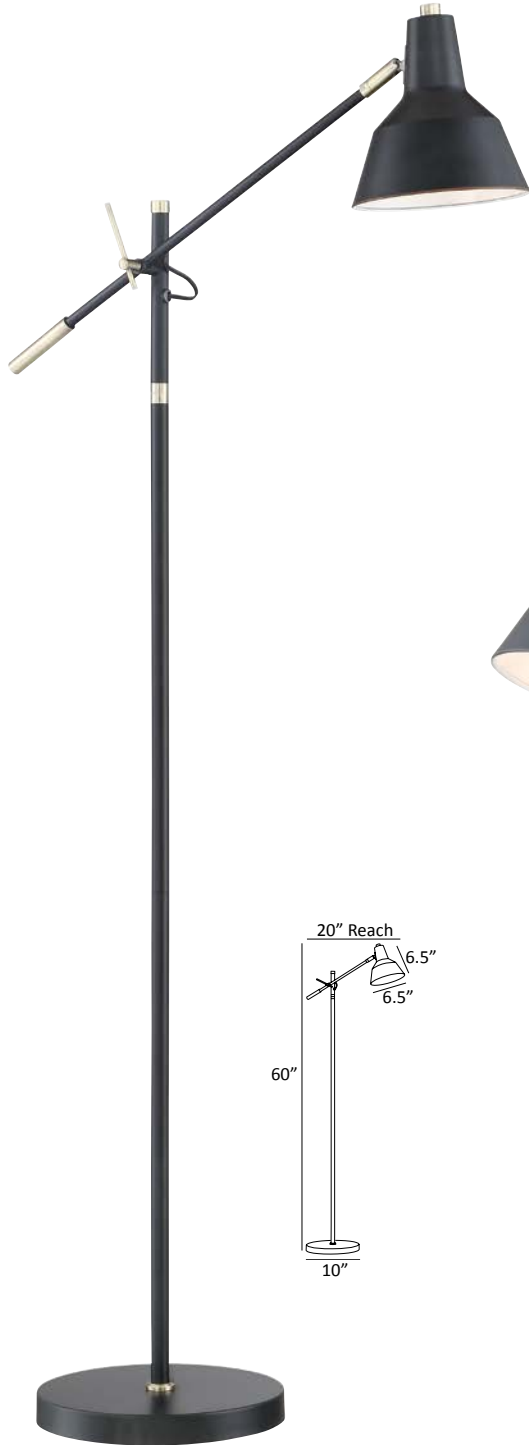

LS-83101 · Tremont Floor Lamp

Body: Black & Antique Brass / Metal
 Shade: Black / Metal
 Switch: On/Off Rotary on Shade
 Lamp: E-27 Medium Base (Max. 60W)
 Features: **Adjustable Arm & Shade**

LS-23101 · Tremont Desk Lamp

Body: Black & Antique Brass / Metal
 Shade: Black / Metal
 Switch: On/Off Rotary on Shade
 Lamp: E-27 Medium Base (Max. 60W)
 Features: **Adjustable Arm & Shade**

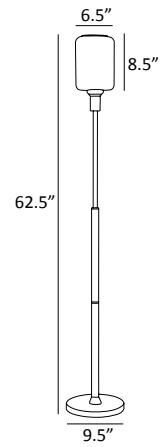
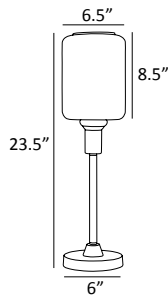

LS-23112 · Luken Table Lamp

Body: Black & Antique Brass / Metal
 Shade: Seeded / Glass
 Switch: On/Off In-Line
 Lamp: E-27 Medium Base (Max. 60W)
 Features: **60W Vintage Edison Bulb Included**

LS-83112 · Luken Floor Lamp

Body: Black & Antique Brass / Metal
 Shade: Seeded / Glass
 Switch: On/Off Foot
 Lamp: E-27 Medium Base (Max. 60W)
 Features: **60W Vintage Edison Bulb Included**

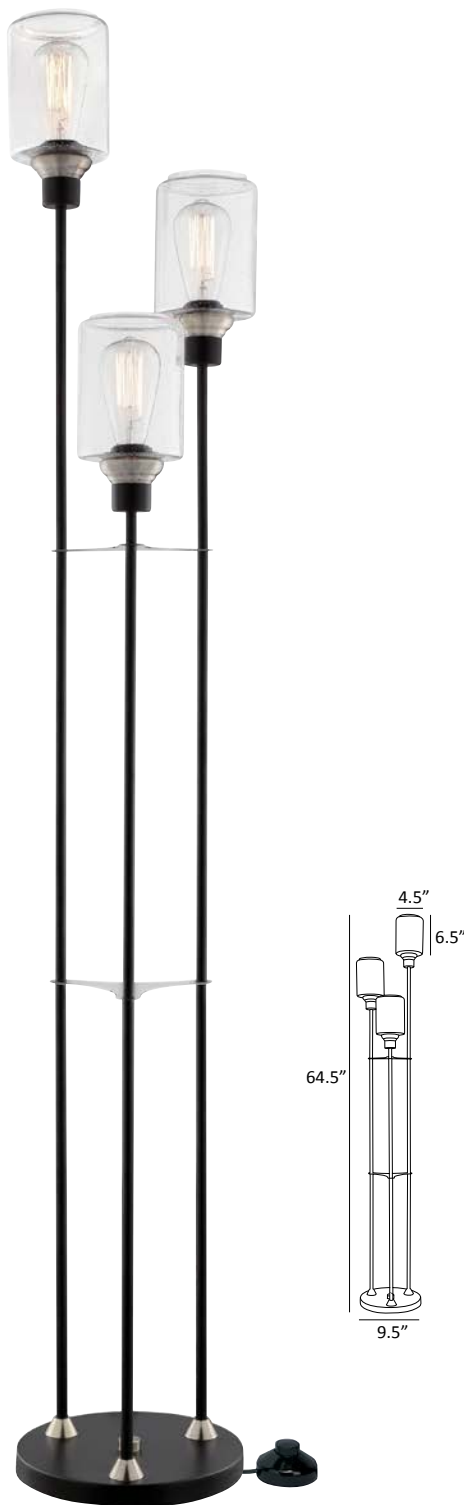

LS-23113 · Luken 3-Lite Table Lamp

Body: Black & Antique Brass / Metal
 Shade: Seeded / Glass
 Switch: On/Off In-Line
 Lamp: E-27 Medium Base (Max. 60W) x3
 Features: **60W Vintage Edison Bulbs Included, Multi-Tier Design, Decorative Shelves**

LS-83113 · Luken 3-Lite Floor Lamp

Body: Black & Antique Brass / Metal
 Shade: Seeded / Glass
 Switch: On/Off Foot
 Lamp: E-27 Medium Base (Max. 60W) x3
 Features: **60W Vintage Edison Bulbs Included, Multi-Tier Design, Decorative Shelves**





LS-23264BLK · Norman Table Lamp
 Body: Black / Metal
 Shade: Clear Seeded / Glass
 Switch: On/Off Rocker on Base
 Bulb Base: E-27 Medium Base (Max. 60W)
 Features: **T Type Vintage Edison Bulb Included**

LS-83264BLK · Norman Floor Lamp
 Body: Black / Metal
 Shade: Clear Seeded / Glass
 Switch: On/Off Foot
 Bulb Base: E-27 Medium Base (Max. 60W)
 Features: **T Type Vintage Edison Bulb Included**

ELENA

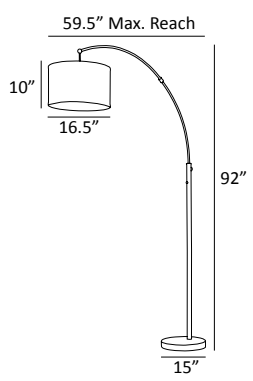
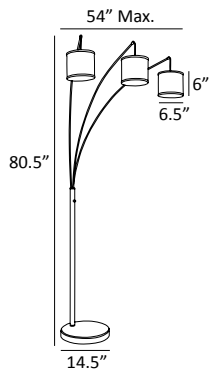

TRANSITIONAL

LS-83106 · Elena 3-Lite Arc Floor Lamp

Body: Black & Antique Brass / Metal
 Shade: Black Net Metal / Linen Fabric
 Switch: 3-Way Rotary on Pole
 Lamp: E-12 Candelabra Base (Max. 40W) x3
 Features: **Marble Base, Double-Layer Shade, 3-Way Switch**

LS-83104 · Elena Arc Floor Lamp

Body: Black & Antique Brass / Metal
 Shade: Black Net Metal / Linen Fabric
 Switch: On/Off Foot
 Lamp: E-27 Medium Base (Max. 100W)
 Features: **Marble Base, Double-Layer Shade**

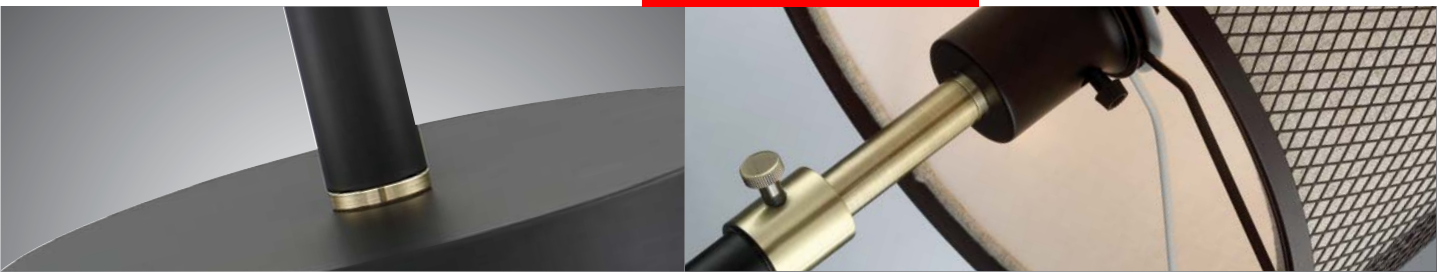

LS-23100 · Elena Table Lamp
 Body: Black & Antique Brass / Metal
 Shade: Black Net Metal / Linen Fabric
 Switch: On/Off Socket
 Lamp: E-27 Medium Base (Max. 60W)
 Features: **Double-Layer Shade, Adjustable Height**

LS-83100 · Elena Floor Lamp
 Body: Black & Antique Brass / Metal
 Shade: Black Net Metal / Linen Fabric
 Switch: On/Off Socket
 Lamp: E-27 Medium Base (Max. 60W)
 Features: **Double-Layer Shade, Adjustable Height**

MACALL

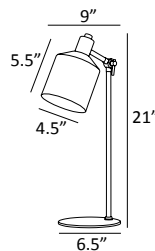
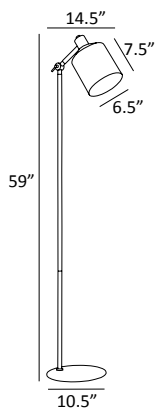

LS-83098BLK · Macall Floor Lamp

Body: Black & Antique Brass / Metal
 Shade: Black / Metal
 Switch: On/Off Foot
 Lamp: E-27 Medium Base (Max. 60W)
 Features: **Adjustable Arm & Shade**

LS-23098BLK · Macall Desk Lamp

Body: Black & Antique Brass / Metal
 Shade: Black / Metal
 Switch: On/Off In-Line
 Lamp: E-12 Candelabra Base (Max. 40W)
 Features: **Adjustable Arm & Shade**

TRANSITIONAL

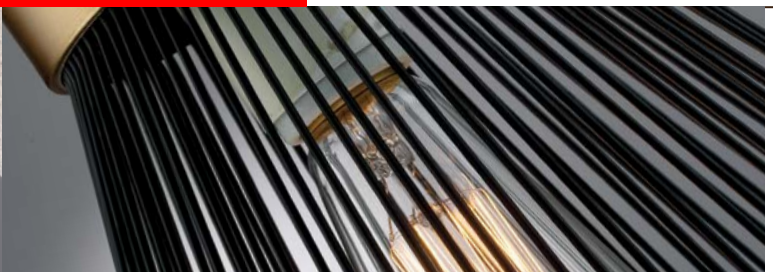
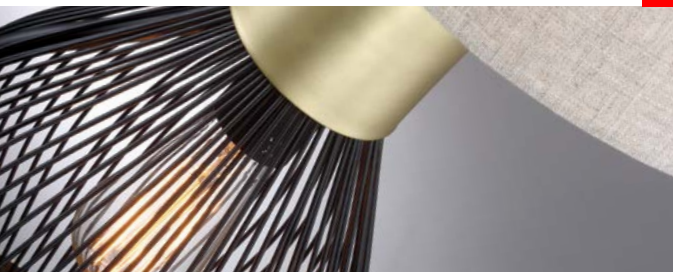

Scan For Video Presentation

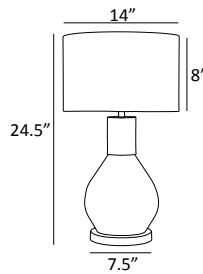
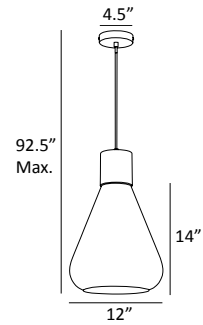

LS-23093 · Freira Table Lamp
Body: Black & Antique Brass / Metal
Shade: Linen / Fabric
Switch: 3-Way Socket
Main Lamp: E-27 Medium Base (Max. 60W)
Nightlight: E-27 Medium Base (Max. 25W)
Features: **Nightlight, 3-Way Switch**

LS-19093 · Freira Pendant
Body: Black & Antique Brass / Metal
Shade: Black & Antique Brass / Metal
Lamp: E-27 Medium Base
Features: Max. 60W



Scan For Video Presentation

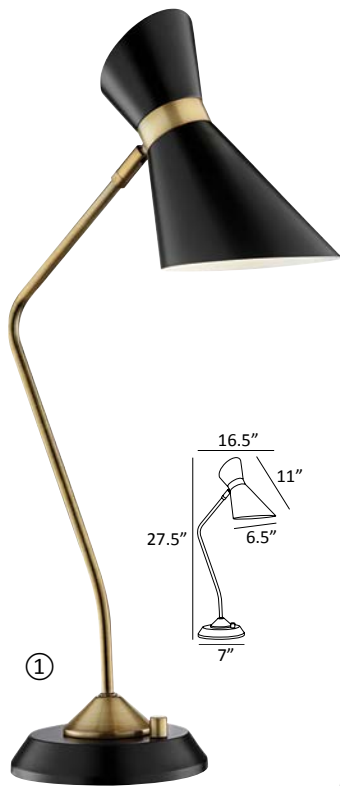

①



②



③

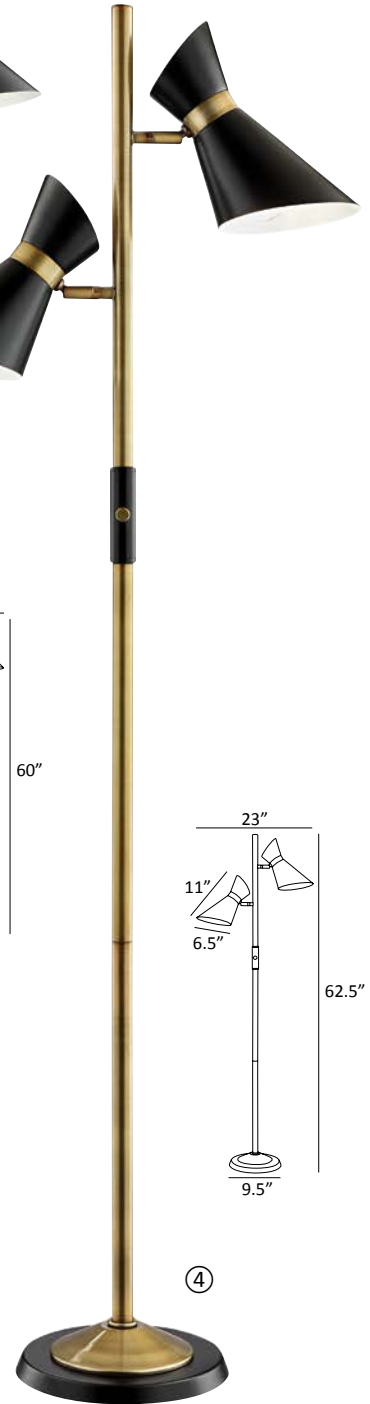

④

LS-23135 ① · Jared Table Lamp
 Body: Antique Brass & Black / Metal
 Shade: Black / Metal
 Switch: On/Off Rotary on Base
 Lamp: E-27 Medium Base (Max. 60W)
 Features: **Adjustable Shade**

LS-83136 ③ · Jared 2-Lite Floor Lamp
 Body: Antique Brass & Black / Metal
 Shade: Black / Metal
 Switch: On/Off Rotary on Pole
 Lamp: E-27 Medium Base (Max. 60W) x2
 Features: **Adjustable Shades**

LS-83135 ② · Jared Floor Lamp
 Body: Antique Brass & Black / Metal
 Shade: Black / Metal
 Switch: On/Off Rotary on Pole
 Lamp: E-27 Medium Base (Max. 60W)
 Features: **Adjustable Shade**

LS-83137 ④ · Jared 2-Lite Floor Lamp
 Body: Antique Brass & Black / Metal
 Shade: Black / Metal
 Switch: On/Off Rotary on Pole
 Lamp: E-27 Medium Base (Max. 60W) x2
 Features: **Adjustable Shades**



Scan For Video
Presentation



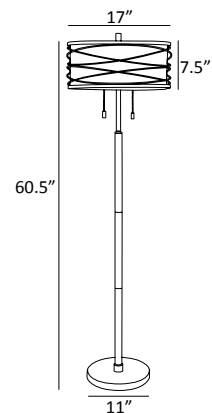
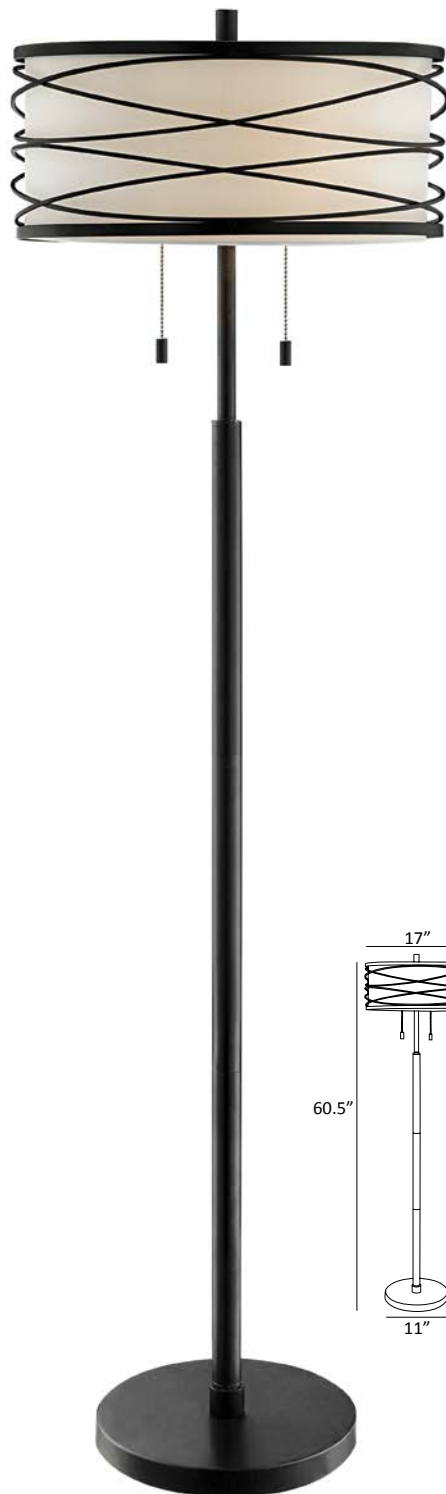
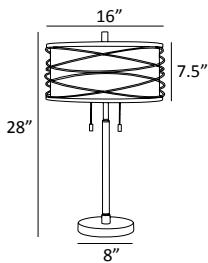

LS-23125 · Lumiere 2-Lite Table Lamp

Body: Dark Bronze / Metal
 Shade: Dark Bronze Metal / Off-White Fabric
 Switch: Dual Pull-Chain
 Lamp: E-27 Medium Base (Max. 60W) x2
 Features: **Double-Layer Shade, Fabric Top Diffuser**

LS-83125 · Lumiere 2-Lite Floor Lamp

Body: Dark Bronze / Metal
 Shade: Dark Bronze Metal / Off-White Fabric
 Switch: Dual Pull-Chain
 Lamp: E-27 Medium Base (Max. 60W) x2
 Features: **Double-Layer Shade, Fabric Top Diffuser**

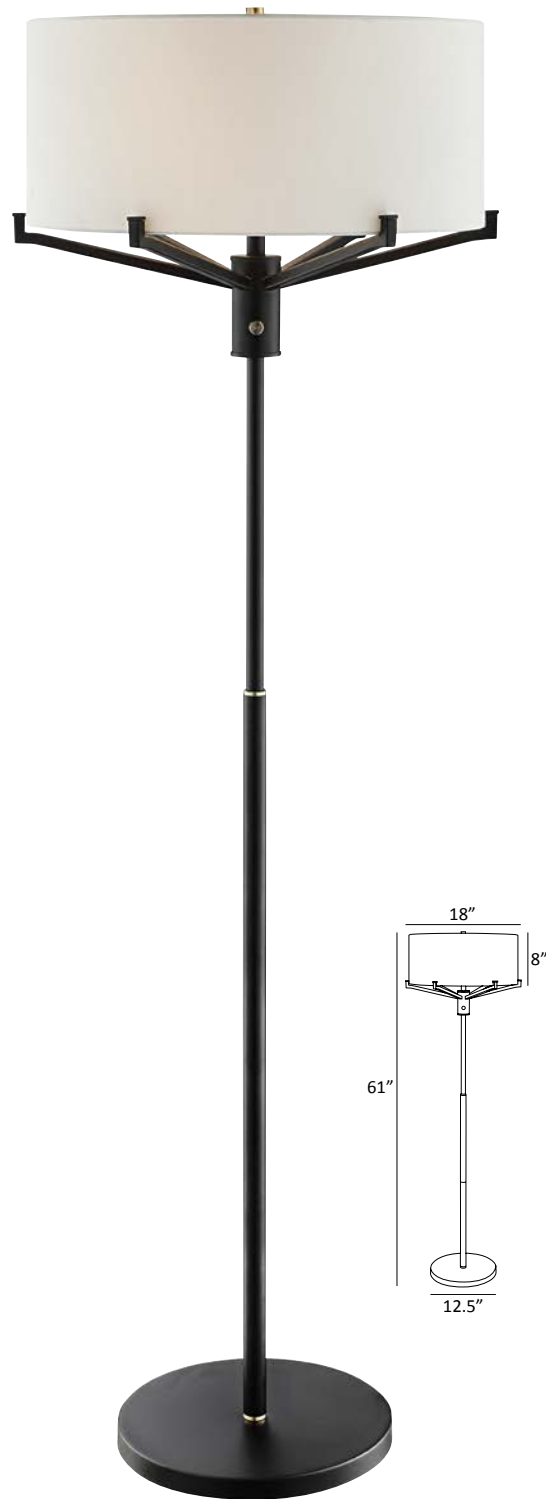

LS-23157 · Jerod 3-Lite Table Lamp

Body: Black & Antique Brass / Metal
 Shade: White / Fabric
 Switch: 3-Way Rotary on Pole
 Lamp: E-27 Medium Base (Max. 60W) x3
 Features: **3-Light, 3-Way Switch**

LS-83157 · Jerod 3-Lite Floor Lamp

Body: Black & Antique Brass / Metal
 Shade: White / Fabric
 Switch: 3-Way Rotary on Pole
 Lamp: E-27 Medium Base (Max. 60W) x3
 Features: **3-Light, 3-Way Switch**

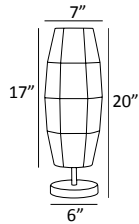
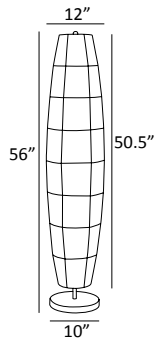
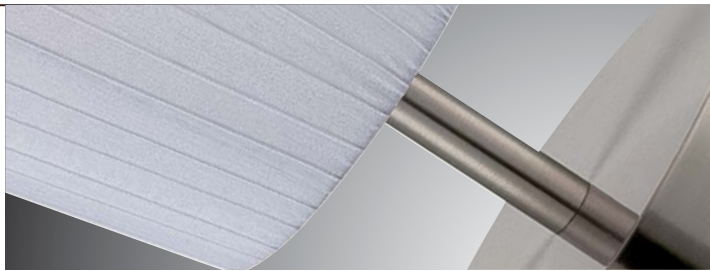

LS-21270AB/AMB · Parvati Table Lamp

Body: Antique Brass / Metal
 Shade: Amber Ribbon / Organza
 Switch: On/Off In-Line
 Lamp: E-27 Medium Base (Max. 60W)

LS-81270AB/AMB · Parvati Floor Lamp

Body: Antique Brass / Metal
 Shade: Amber Ribbon / Organza
 Switch: On/Off Foot
 Lamp: E-12 Candelabra Base (Max. 60W) x3

LS-81270PS/WHT · Parvati Floor Lamp

Body: Polished Steel / Metal
 Shade: White Ribbon / Organza
 Switch: On/Off Foot
 Lamp: E-12 Candelabra Base (Max. 60W) x3



Scan For Video Presentation

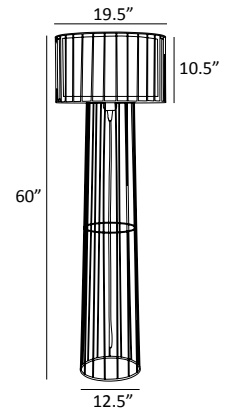
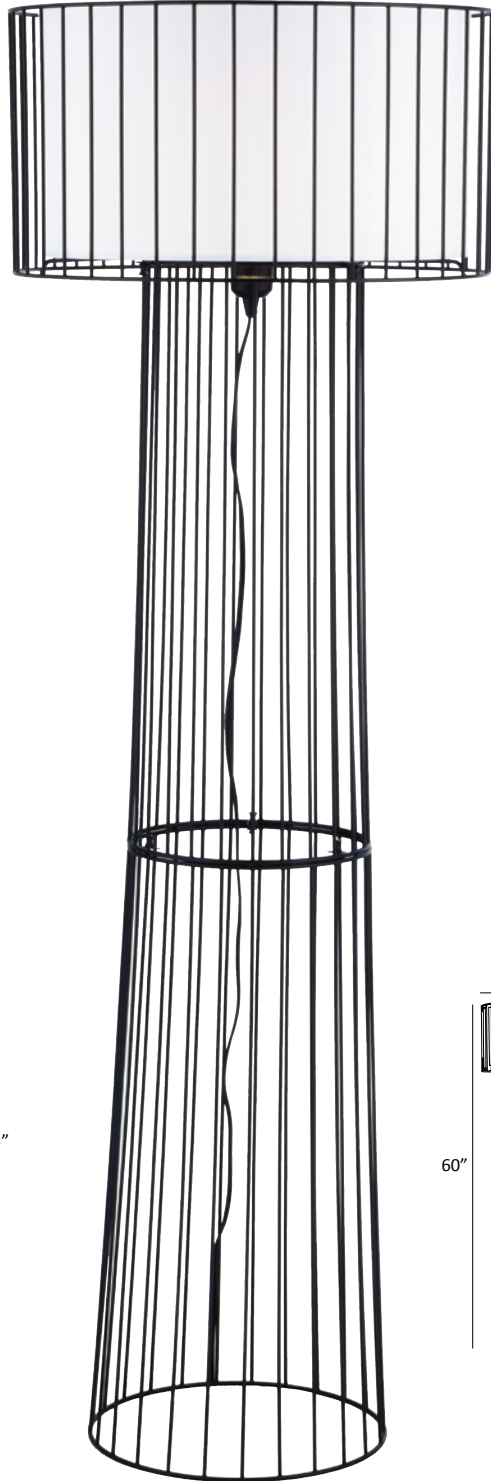
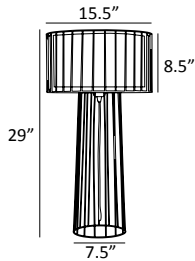

LS-23035 · Winslow Table Lamp

Body: Black / Metal
Shade: Black Metal / Off-White Fabric
Switch: On/Off In-Line
Lamp: E-27 Medium Base (Max. 100W)
Features: **Double-Layer Shade**

LS-83035 · Winslow Floor Lamp

Body: Black / Metal
Shade: Black Metal / Off-White Fabric
Switch: On/Off Foot
Lamp: E-27 Medium Base (Max. 150W)
Features: **Double-Layer Shade**

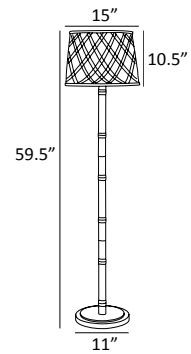
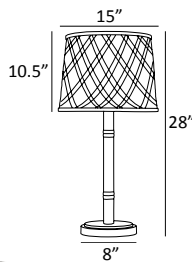
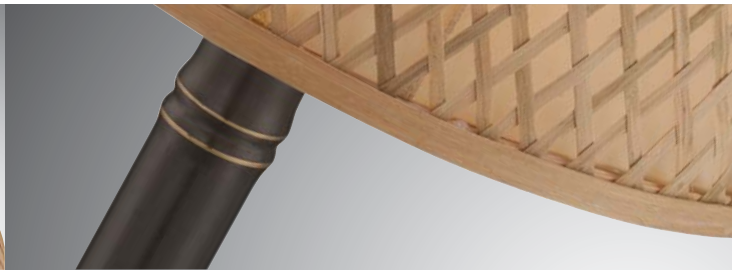
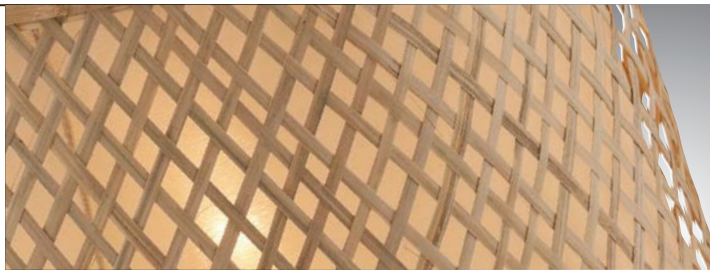

LS-22784 · Tamarice Table Lamp
 Body: Dark Bronze / Metal
 Shade: Natural Rattan / Bamboo
 Switch: On/Off Socket
 Lamp: E-27 Medium Base (Max. 100W)

LS-82784 · Tamarice Floor Lamp
 Body: Dark Bronze / Metal
 Shade: Natural Rattan / Bamboo
 Switch: On/Off Socket
 Lamp: E-27 Medium Base (Max. 100W)



LS-23020 · Barend Table Lamp
Body: Dark Walnut Finish / Wood
Shade: Linen / Fabric
Switch: On/Off Socket
Lamp: E-27 Medium Base (Max. 150W)

LS-83020 · Barend Floor Lamp
Body: Dark Walnut Finish / Wood
Shade: Linen / Fabric
Switch: On/Off Socket
Lamp: E-27 Medium Base (Max. 150W)

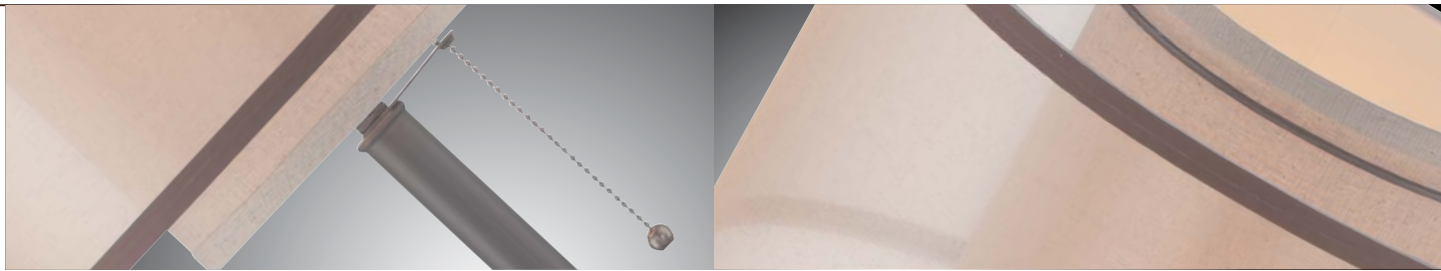

LS-22707 · Fabrizio Table Lamp

Body: Dark Bronze / Metal
 Shade: Gold Organza / Linen Fabric
 Switch: On/Off Pull-Chain
 Lamp: E-27 Medium Base (Max. 100W)
 Features: **Double-Layer Shade**

LS-82707 · Fabrizio Floor Lamp

Body: Dark Bronze / Metal
 Shade: Gold Organza / Linen Fabric
 Switch: On/Off Pull-Chain
 Lamp: E-27 Medium Base (Max. 100W)
 Features: **Double-Layer Shade**



LS-23079 · Kurtis Table Lamp

Body: Brushed Bronze / Metal
Shade: Off-White / Fabric
Switch: On/Off Socket
Lamp: E-27 Medium Base (Max. 100W)



LS-83079 · Kurtis Table Lamp

Body: Brushed Bronze / Metal
Shade: Off-White / Fabric
Switch: On/Off Socket
Lamp: E-27 Medium Base (Max. 100W)



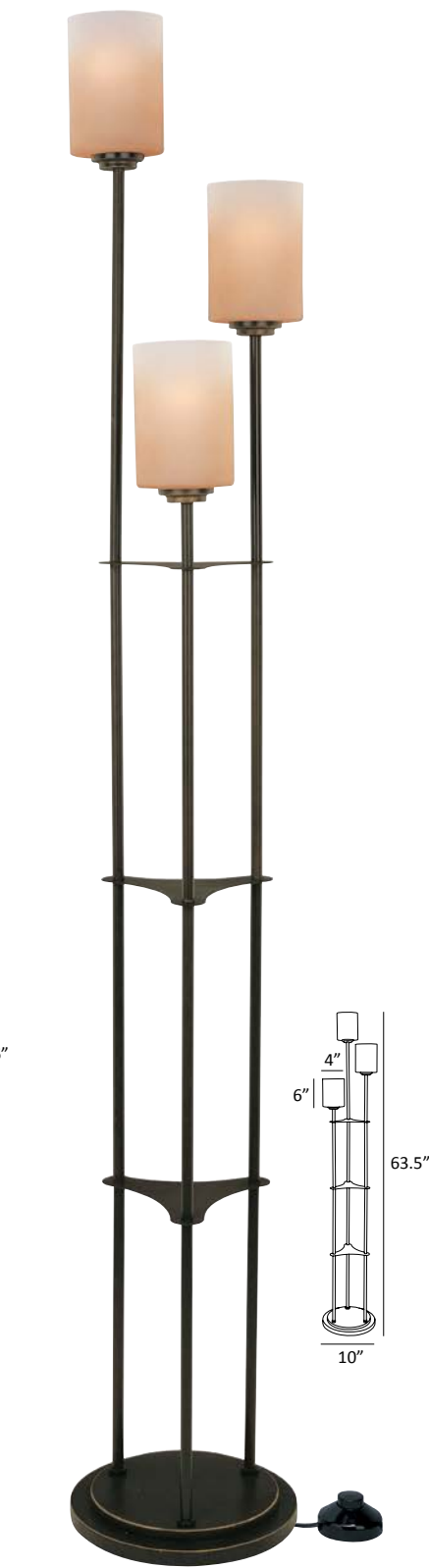

LS-80701D/BRZ · Bess Floor Lamp

Body: Dark Bronze / Metal
 Shade: Light Amber / Glass
 Switch: On/Off Foot
 Lamp: E-27 Medium Base (Max. 60W) x4
 Features: **Multi-Tier Design, Decorative Shelves**

LS-80700D/BRZ · Bess Floor Lamp

Body: Dark Bronze / Metal
 Shade: Light Amber / Glass
 Switch: On/Off Foot
 Lamp: E-27 Medium Base (Max. 60W) x3
 Features: **Multi-Tier Design, Decorative Shelves**

LS-20700D/BRZ · Bess Table Lamp

Body: Dark Bronze / Metal
 Shade: Light Amber / Glass
 Switch: 3-Way Rotary on Base
 Lamp: E-27 Medium Base (Max. 60W) x3
 Features: **Multi-Tier Design, Decorative Shelves**

TACEY
MAXWELL

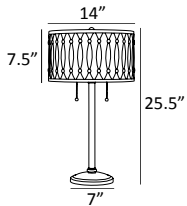
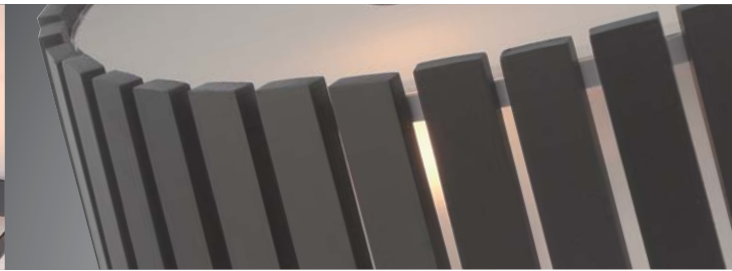

①

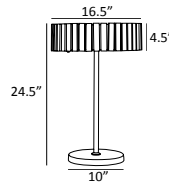

②

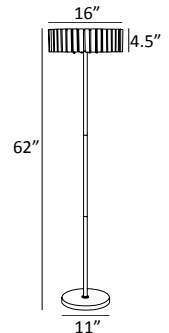

③

TRANSITIONAL

LS-22729 ① · Tacey Table Lamp

Body: Dark Bronze / Metal
 Shade: Dark Bronze Metal / White Fabric
 Switch: Dual On/Off Pull-Chain
 Lamp: E-27 Medium Base (Max. 60W) x2
 Features: **Double-Layer Shade**

LS-22868 ② · Maxwell Table Lamp

Body: Chrome / Metal
 Shade: Espresso Finish Wood / Frosted Glass
 Switch: On/Off In-Line
 Lamp: E-27 Medium Base (Max. 60W) x3
 Features: **Double-Layer Shade**

LS-82868 ③ · Maxwell Floor Lamp

Body: Chrome / Metal
 Shade: Espresso Finish Wood / Frosted Glass
 Switch: On/Off Foot
 Lamp: E-27 Medium Base (Max. 60W) x3
 Features: **Double-Layer Shade**

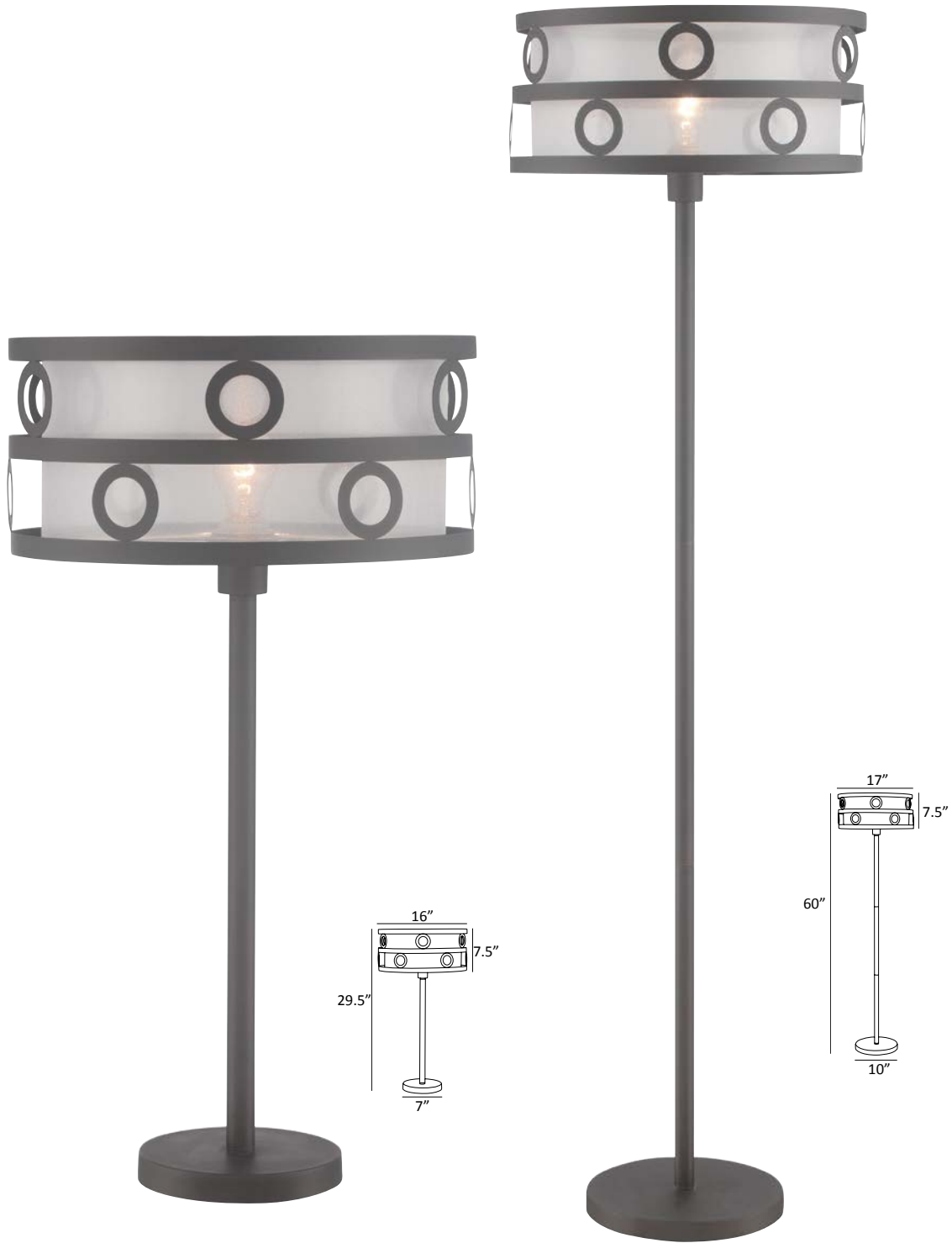
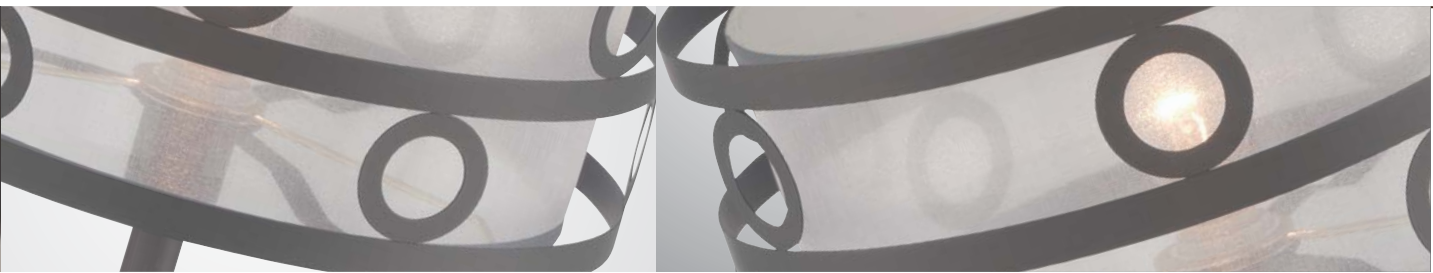

LS-22833 · Lavinia Table Lamp
 Body: Burnished Bronze / Metal
 Shade: Burnished Bronze Metal / Clear Oganza
 Switch: On/Off In-Line
 Lamp: E-27 Medium Base (Max. 100W)
 Features: **Double-Layer Shade**

LS-82833 · Lavinia Floor Lamp
 Body: Burnished Bronze / Metal
 Shade: Burnished Bronze Metal / Clear Oganza
 Switch: On/Off Foot
 Lamp: E-27 Medium Base (Max. 100W)
 Features: **Double-Layer Shade**

TARIKA
PARDES
ULYANA



LS-22764 ① · Tarika Table Lamp
 Body: Dark Bronze & Gold / Metal
 Shade: Linen / Fabric
 Switch: On/Off In-Line
 Lamp: E-27 Medium Base (Max. 100W)
 Features: **Swing-Arm**

LS-22786 ② · Pardes Table Lamp
 Body: Dark Bronze / Metal
 Shade: Linen / Fabric
 Switch: ON/Off In-Line
 Lamp: E-27 Medium Base (Max. 100W)
 Features: **Adjustable Height**

LS-82703 ③ · Ulyana Floor Lamp
 Body: Dark Bronze & Gold / Metal
 Shade: Linen / Fabric
 Switch: On/Off Socket
 Lamp: E-27 Medium Base (Max. 100W)
 Features: **Adjustable Arm & Shade**



LS-82139D/BRZ ① · Eveleen Floor Lamp **LS-82138D/BRZ ② · Eveleen Floor Lamp** **LS-22139D/BRZ ③ · Eveleen Table Lamp**
 Body: Dark Bronze / Metal Shade: Light Beige Linen / Fabric Switch: On/Off Socket
 Lamp: E-27 Medium Base (Max. 100W) Lamp: E-27 Medium Base (Max. 100W) Lamp: E-27 Medium Base (Max. 100W)
 Features: **Swing Arm, Clear Glass Table Top** Features: **Swing Arm** Features: **Swing Arm**





①

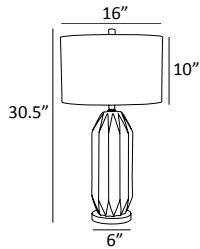

②

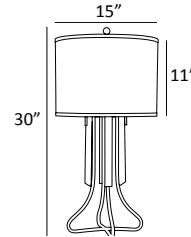

Scan For Video Presentation



③

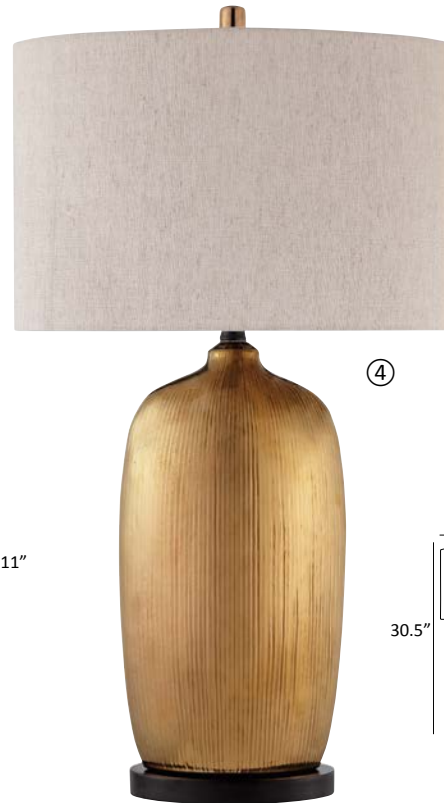
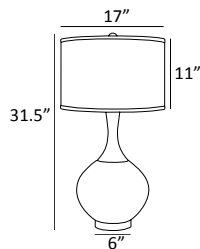

④

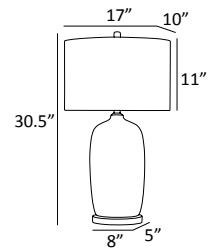

LS-23060 ① · Philana Table Lamp

Body: White & Gold / Ceramic
 Shade: Off-White / Fabric
 Switch: 3-Way Socket
 Lamp: E-27 Medium Base (Max. 150W)
 Features: **3-Way Switch, Acrylic Base**

LS-23170 ③ · Vanessa Table Lamp

Body: Mercury Mirror / Glass
 Shade: White / Linen
 Switch: On/Off Socket
 Lamp: E-27 Medium Base (Max. 100W)

LS-23065 ② · Chantelle Table Lamp

Body: Gold / Metal
 Shade: Beige / Fabric
 Switch: Dual Pull-Chain
 Lamp: E-27 Medium Base (Max. 60W) x2
 Features: **Acrylic Accents**

LS-23197 ④ · Mateo Table Lamp

Body: Aged Copper / Ceramic
 Shade: Linen / Fabric
 Switch: 3-Way Socket
 Lamp: E-27 Medium Base (Max. 150W)
 Features: **3-Way Switch**

CLAYTON
TRUSSON
COVINGTON
MURPHY



Scan For Video
Presentation



①



②

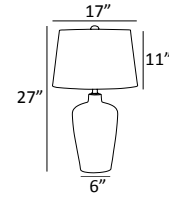

③

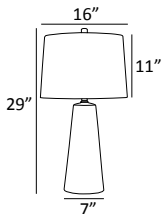

④

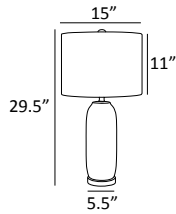

⑤

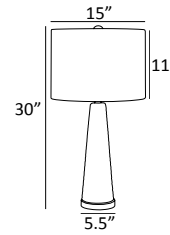

TRANSITIONAL

LS-23062 ①

LS-23062WHT ② · Clayton Table Lamp

Body: Aged Silver / Ceramic
Shade: Grey Linen or White / Fabric
Switch: 3-Way Socket
Lamp: E-27 Medium Base (Max. 150W)
Features: **3-Way Switch**

LS-23180 ③ · Trusson Table Lamp

Body: Espresso Wood / Ceramic
Shade: Linen / Fabric
Switch: 3-Way Socket
Lamp: E-27 Medium Base (Max. 150W)
Features: **3-Way Switch**

LS-23186 ④ · Covington Table Lamp

Body: Aged Bronze / Ceramic
Shade: Linen / Fabric
Switch: 3-Way Socket
Lamp: E-27 Medium Base (Max. 150W)
Features: **3-Way Switch, Fabric Top Diffuser**

LS-23196 ⑤ · Murphy Table Lamp

Body: Gunmetal / Ceramic
Shade: Linen / Fabric
Switch: 3-Way Socket
Lamp: E-27 Medium Base (Max. 150W)
Features: **3-Way Switch, Fabric Top Diffuser**

MILTON
EFTON
BLAINE
MULLER
ANTON



LS-23056 ① · Milton Table Lamp

Body: Matte Black / Metal
Shade: Linen / Fabric
Switch: 3-Way Socket
Lamp: E-27 Medium Base (Max. 150W)
Features: **3-Way Switch**

LS-23057 ② · Efton Table Lamp

Body: Matte Black / Metal
Shade: Linen / Fabric
Switch: 3-Way Socket
Lamp: E-27 Medium Base (Max. 150W)
Features: **3-Way Switch**

LS-23058 ③ · Blaine Table Lamp

Body: Matte Black / Metal
Shade: Linen / Fabric
Switch: 3-Way Socket
Lamp: E-27 Medium Base (Max. 150W)
Features: **3-Way Switch**

LS-23086D/BRZ ④ · Muller Table Lamp

Body: Dark Bronze / Metal
Shade: Light Beige Linen / Fabric
Switch: On/Off Socket
Lamp: E-27 Medium Base (Max. 100W)

LS-23142 ⑤ · Anton Table Lamp

Body: Black Iron / Metal
Shade: Linen / Fabric
Switch: 3-Way Socket
Main Lamp: E-27 Medium Base (Max. 100W)
Nightlight: E-27 Medium Base (Max. 40W)
Features: **3-Way Switch, Nightlight, 40W Vintage Edison Bulb Included**

BRENTON
SADLER
WAYDE
EARLEEN II
CASSIOPEIA



LS-22526 ① · Brenton Table Lamp
Body: Dark Bronze / Metal
Shade: Linen / Fabric
Switch: On/Off Socket
Lamp: E-27 Medium Base (Max. 100W)

LS-22660 ② · Sadler Table Lamp
Body: Antique Silver Polyresin / Dark Bronze Metal
Shade: Beige Linen / Fabric
Switch: 3-Way Socket
Lamp: E-27 Medium Base (Max. 150W)
Features: **3-Way Switch**

LS-22675 ③ · Wayde Table Lamp
Body: Gun Metal / Black Polyresin
Shade: Off-White / Fabric
Switch: On/Off Socket
Lamp: E-27 Medium Base (Max. 100W)

LS-22743 ④ · Earleen II Table Lamp
Body: Black / Metal
Shade: Linen / Fabric
Switch: ON/Off Socket
Lamp: E-27 Medium Base (Max. 60W)

LS-22947 ⑤ · Cassiopeia Table Lamp
Body: Black / Metal
Shade: Linen / Fabric
Switch: 3-Way Socket
Lamp: E-27 Medium Base (Max. 100W)
Features: **3-Way Switch**



CIRCLINE
ENKEL
PIERRE
FIRMINO
ELDORA

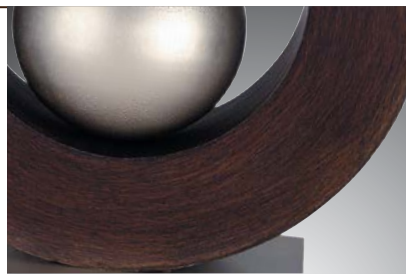

LS-2449 ① · Circline Table Lamp

Body: Dark Walnut Resin / Satin Nickel Metal
Shade: Off-White / Fabric
Switch: 3-Way Socket
Lamp: E-27 Medium Base (Max. 150W)
Features: **3-Way Switch**

LS-21330 ② · Enkel Table Lamp

Body: Dark Walnut Resin / Satin Nickel Metal
Shade: Linen / Fabric
Switch: 3-Way Socket
Lamp: E-27 Medium Base (Max. 100W)
Features: **3-Way Switch**

LS-21618 ③ · Pierre Table Lamp

Body: Dark Walnut Resin / Brushed Nickel Metal
Shade: Linen / Fabric
Switch: On/Off In-Line
Lamp: E-27 Medium Base (Max. 60W)

LS-22069 ④ · Firmino Table Lamp

Body: Walnut Resin / Chrome Metal
Shade: Off-White / Fabric
Switch: On/Off Socket
Lamp: E-27 Medium Base (Max. 100W)

LS-22205 ⑤ · Eldora Table Lamp

Body: Dark Walnut Resin / Brushed Nickel Metal
Shade: Off-White / Fabric
Switch: On/Off Socket
Lamp: E-27 Medium Base (Max. 100W)

TRANSITIONAL



①



②

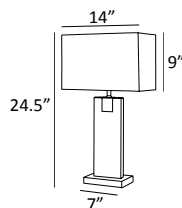

③

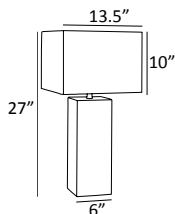

④

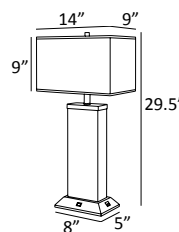
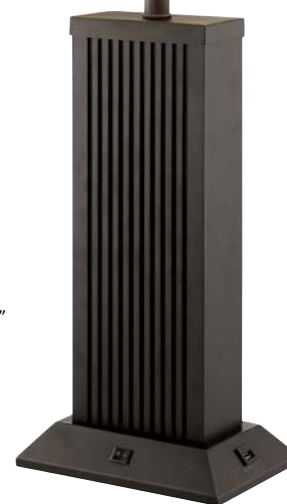

LS-21282BLK/BLK ①

LS-21282BLK/WHT ② · Remigio Table Lamp

Body: Black Faux Leather / Chrome Metal
Shade: Black or White / Fabric
Switch: On/Off Socket
Lamp: E-27 Medium Base (Max. 60W)

LS-2937DBRN/LTR ③

· Leatherman Table Lamp

Body: Dark Brown / Faux Leather
Shade: Off-White / Fabric
Switch: 3-Way Socket
Lamp: E-27 Medium Base (Max. 150W)
Features: **3-Way Switch**

LS-23219 ④ · Darrion Table Lamp

Body: Black / Resin
Shade: Off-White / Fabric
Switch: On/Off Rocker on Base
Lamp: E-27 Medium Base (Max. 60W)
Features: **USB Charging Port x1, AC Outlet x1**



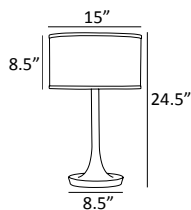
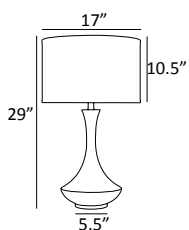

LS-22079 ①
LS-22079D/BRZ ② · Elisio Table Lamp
 Body: Brushed Nickel or Dark Bronze / Metal
 Shade: Off-White or Linen / Fabric
 Switch: 3-Way Socket
 Lamp: E-27 Medium Base (Max. 150W)
 Features: **3-Way Switch**

LS-22655D/BRZ ③
LS-22655PS ④ · Baha Table Lamp
 Body: Dark Bronze or Polished Steel / Metal
 Shade: Linen Fabric / Diffuser
 Switch: On/Off Socket
 Lamp: E-27 Medium Base (Max. 150W)

D A R I O
C R U Z I T O
D A N T E
D I C K E N S



①

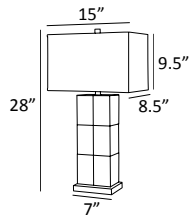

②

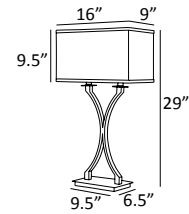

③

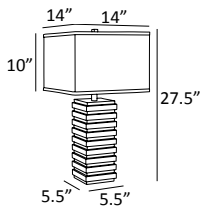

④

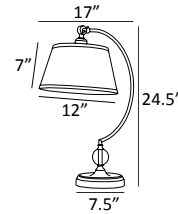

LS-21986 ① · Dario Table Lamp

Body: Mirror Glass / Chrome Metal
Shade: Black Transparent / Mylar
Switch: On/Off Socket
Lamp: E-27 Medium Base (Max. 100W)
Features: **Mylar Transparent Shade**

LS-22615 ② · Cruzito Table Lamp

Body: Antique Brass / Metal
Shade: Off-White / Fabric
Switch: On/Off In-Line
Lamp: E-27 Medium Base (Max. 60W) x2

LS-22674 ③ · Dante Table Lamp

Body: Dark Walnut & Brushed Nickel / Metal
Shade: Off-White / Fabric
Switch: 3-Way Socket
Lamp: E-27 Medium Base (Max. 150W)
Features: **3-Way Switch**

LS-22690 ④ · Dickens Table Lamp

Body: Antique Brass Metal / Clear Crystal
Shade: Off-White / Fabric
Switch: On/Off In-Line
Lamp: E-27 Medium Base (Max. 100W)
Features: **Crystal Accent**

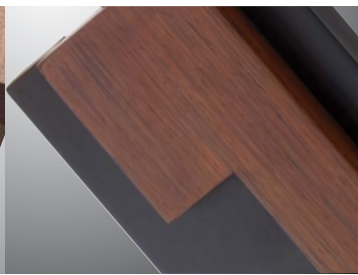
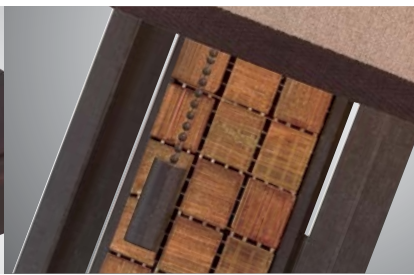
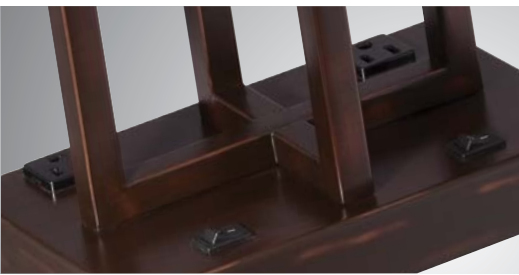

**F A R R E N
V O L T E R R A
M A R Q U E T T A
G O V E R T**

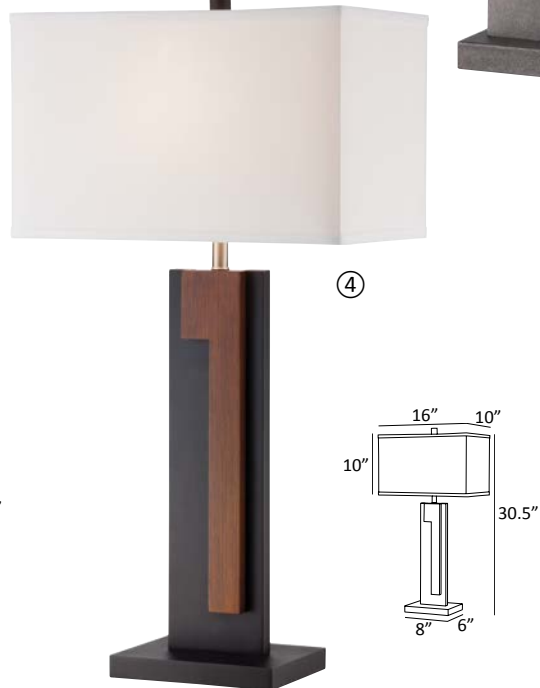
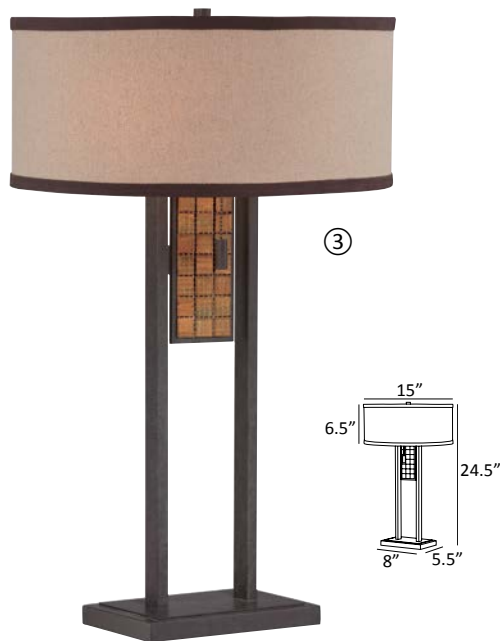

LS-22542 ① · Farren Table Lamp
 Body: Dark Bronze / Metal
 Shade: Linen Fabric / Diffuser
 Switch: Dual On/Off Rocker on Base
 Lamp: E-27 Medium Base (Max. 60W) x2
 Features: **AC Outlet x2**

LS-22564 ② · Volterra Table Lamp
 Body: Antique Patina / Metal
 Shade: Off-White / Fabric
 Switch: On/Off Socket
 Lamp: E-27 Medium Base (Max. 100W)

LS-22896 ③ · Marquetta Table Lamp
 Body: Aged Bronze Metal / Amber Mosaic
 Shade: Beige w. Brown Trim / Fabric
 Switch: Dual On/Off Pull-Chain
 Lamp: E-27 Medium Base (Max. 60W) x2

LS-22949 ④ · Govert Table Lamp
 Body: 2-Tone Wood / Brushed Nickel Metal
 Shade: Off-White / Fabric
 Switch: On/Off Socket
 Lamp: E-27 Medium Base (Max. 100W)

TRANSITIONAL

NARVAL
CLARAL
MONICO
BAKER
OVDIA

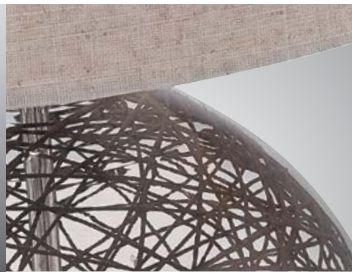

①

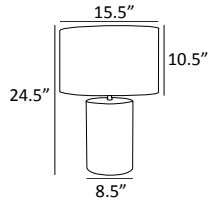

②

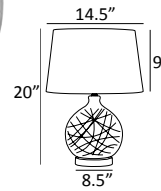

③

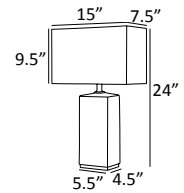

④

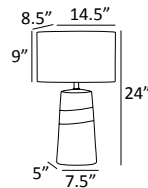

⑤

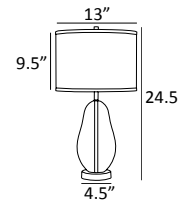

LS-21024 ① · Narvel Table Lamp
Body: Dark Walnut / Ceramic
Shade: Linen Elliptical / Fabric
Switch: On/Off Socket
Lamp: E-27 Medium Base (Max. 100W)

LS-22747 ② · Claral Table Lamp
Body: Clear Glass / Chrome Metal
Shade: Linen / Fabric
Switch: On/Off In-Line
Lamp: E-27 Medium Base (Max. 100W)
Features: **Metal Wire Rattan Decò**

LS-22754 ③ · Monico Table Lamp
Body: Dark Mustard / Ceramic
Shade: Off-White / Fabric
Switch: On/Off Socket
Lamp: E-27 Medium Base (Max. 100W)

LS-22757 ④ · Baker Table Lamp
Body: 2-Tone Coffee / Ceramic
Shade: Off-White Elliptical / Fabric
Switch: On/Off Socket
Lamp: E-27 Medium Base (Max. 100W)

LS-22893 ⑤ · Ovadia Table Lamp
Body: Smoked Chrome Glass / Gun Metal
Shade: Black / Fabric
Switch: On/Off Socket
Lamp: E-27 Medium Base (Max. 100W)



①

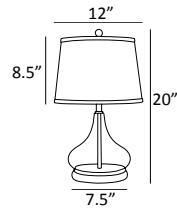

②

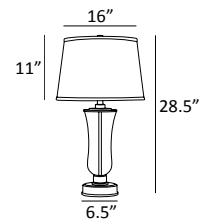

③

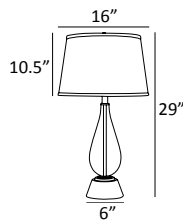

④

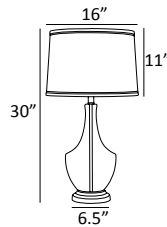

⑤

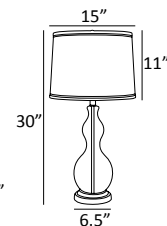

LS-21658 ① · Hendrick Table Lamp

Body: Clear Glass / Black Metal
Shade: Beige Linen / Fabric
Switch: On/Off Socket
Lamp: E-27 Medium Base (Max. 60W)

LS-22547 ② · Prisco Table Lamp

Body: Clear Glass / Dark Bronze Metal
Shade: Off-White / Fabric
Switch: 3-Way Socket
Lamp: E-27 Medium Base (Max. 150W)
Features: **3-Way Switch**

LS-22676 ③ · Pello Table Lamp

Body: Clear Glass / Dark Bronze Metal
Shade: Off-White / Fabric
Switch: On/Off Socket
Lamp: E-27 Medium Base (Max. 100W)

LS-23012 ④ · Caroline Table Lamp

Body: Clear Glass / Dark Bronze Metal
Shade: Linen w. Brown Trim / Fabric
Switch: On/Off Socket
Lamp: E-27 Medium Base (Max. 100W)

LS-23013 ⑤ · Carolina Table Lamp

Body: Clear Glass / Dark Bronze Metal
Shade: Linen w. Brown Trim / Fabric
Switch: On/Off Socket
Lamp: E-27 Medium Base (Max. 100W)





Balanced-Arm w. Spring Suspension



LS-82844BLK ① · Kailano Floor Lamp
 Body: Black / Metal
 Shade: Grey / Fabric
 Switch: On/Off Foot
 Lamp: E-27 Medium Base (Max. 150W)
 Features: **Adjustable Balanced-Arm & Shade**

LS-83115 ② · Doreen Floor Lamp
 Body: Black / Metal
 Shade: Linen / Fabric
 Switch: On/Off Socket
 Lamp: E-27 Medium Base (Max. 100W)
 Features: **Smoke Glass Tray Table, Marble Base**

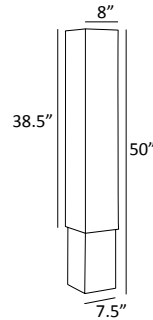

①

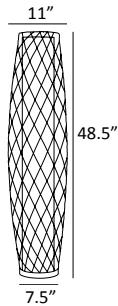

②

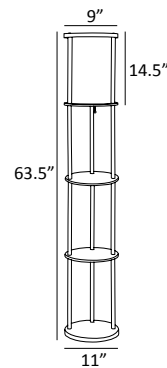

③

LS-81277 ① · Edan Floor Lamp
 Body: Dark Walnut / Wood
 Shade: White Crinkled / Paper
 Switch: On/Off Foot
 Lamp: E-27 Medium Base (Max. 60W) x2

LS-82213 ② · Reaves Floor Lamp
 Base: Black / Metal
 Shade: Brown Rattan / Off-White Fabric
 Switch: On/Off Foot
 Lamp: E-27 Medium Base (Max. 100W) x2

LS-82839BLK ③ · Laina Floor Lamp
 Body: Black / Metal
 Shade: White / Polystyrene
 Switch: On/Off Pull-Chain
 Lamp: E-27 Medium Base (Max. 150W)
 Features: **Shelf Trays**



LS-82533 ① · Vasanti 3-Lite Arc Lamp
 Body: Dark Bronze / Metal
 Shade: Off-White Patterned / Fabric
 Switch: 3-Way Rotary on Pole
 Lamp: E-27 Medium Base (Max. 60W) x3
 Features: **3-Way Switch**

LS-82531 ② · Vasanti Arc Lamp
 Body: Dark Bronze / Metal
 Shade: Off-White Patterned / Fabric
 Switch: On/Off Socket
 Lamp: E-27 Medium Base (Max. 100W)

LS-80708 ③ · Matia 3-Lite Arc Lamp
 Body: Polished Steel / Metal
 Shade: Slotted Walnut Wood / White Fabric
 Switch: 3-Way Rotary on Pole
 Lamp: E-12 Candelabra Base (Max. 40W) x3
 Features: **Double-Layer Shades, 3-Way Switch**

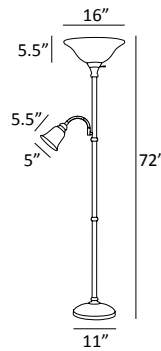
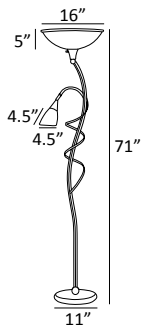

LS-81571 ① · Wavia Torchiere/Reading Lamp

Body: Antique Bronze / Metal
 Shade: Light Amber / Glass
 Switch: 3-Way Socket
 Main Lamp: E-27 Medium Base (Max. 150W)
 Reading Lamp: E-12 Candelabra Base (Max. 40W)
 Features: **Adjustable Reading Lamp**

LS-82550AB ②

LS-82550D/BRZ ③ · Henley Torchiere/Reading Lamp

Body: Antique Brass or Dark Bronze / Metal
 Shade: Light Amber Cloud / Glass
 Switch: Dual On/Off Socket
 Lamp: E-27 Medium Base (Max. 150W)
 Reading Lamp: E-27 Medium Base (Max. 60W)
 Features: **Gooseneck Reading Lamp**

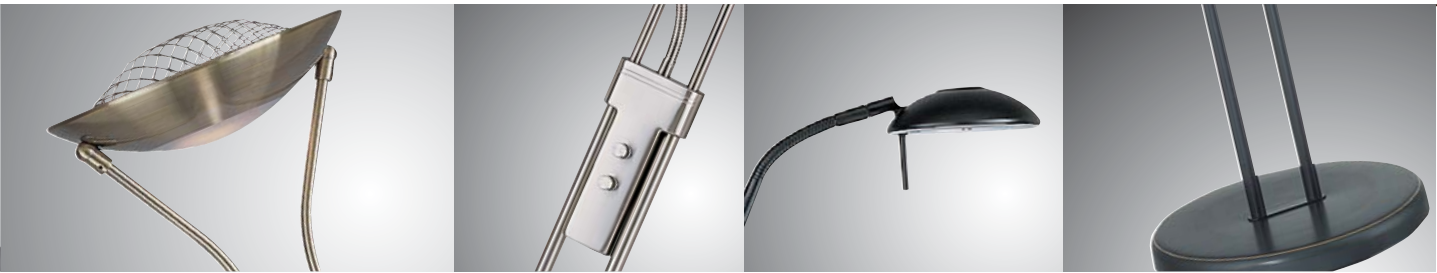

DUALITY II



LS-80984AB ① / LS-80984BLK ② / LS-80984D/BRZ ③ / LS-80984PS ④

· Duality II Torchiere/Reading Lamp

Body: Antique Brass, Black, Dark Bronze or Polished Steel / Metal

Shade: Matching Finish Metal / Frosted Glass Diffuser

Switch: Dual Dimmer Rotary Switches on Pole

Main Lamp: 180W J/118mm Halogen (Max. 180W)

Reading Lamp: 120V JCD/G8 Halogen (Max. 50W)

Features: Halogen Bulbs Included, Circuit Breaker Included, Adjustable Reading Lamp, Dual Dimmer Switches

TRANSITIONAL





LS-23140AB ①

LS-23140BN ② · Randall Table/Desk Lamp

Body: Antique Brass or Brushed Nickel / Metal
 Shade: Matching Finish / Metal
 Switch: Dimmer Rotary on Base
 Lamp: 8W GU10 LED Bulb (2700K, 720lm, CRI: 80)
 Features: **Replaceable & Dimmable LED**

LS-83140AB ③

LS-83140BN ④ · Randall Floor Lamp

Body: Antique Brass or Brushed Nickel / Metal
 Shade: Matching Finish / Metal
 Switch: Dimmer Rotary on Pole
 Lamp: 8W GU10 LED Bulb (2700K, 720lm, CRI: 80)
 Features: **Replaceable & Dimmable LED**





LS-23217AB ①
LS-23217BN ② · Tilman Table/Desk Lamp
 Body: Antique Brass or Brushed Nickel / Metal
 Shade: Matching Finish / Metal
 Switch: Touch Dimmer on Shade
 Lamp: 8W LED Bulb (3500K, 465lm, CRI: 80)
 Features: **Replaceable & Dimmable LED**

LS-83217AB ③
LS-83217BN ④ · Tilman Floor Lamp
 Body: Antique Brass or Brushed Nickel / Metal
 Shade: Matching Finish / Metal
 Switch: Touch Dimmer on Shade
 Lamp: 12W LED Bulb (3500K, 805lm, CRI: 80)
 Features: **Replaceable & Dimmable LED**



LS-83066 ① · Zale LED Torchiere/Reading Lamp

Body: Brushed Nickel / Metal
 Shade: Clear / Acrylic
 Switch: Dual Dimmer Rotary on Pole
 Main Lamp: 18W LED (3000K, 1800lm, CRI: 80)
 Reading Lamp: 5W LED (3000K, 450lm, CRI: 80)
 Features: **Dual Dimmer Switches, Replaceable & Dimmable LED**

LS-83068 ③ · Zale LED Torchiere/Reading Lamp

Body: Brushed Nickel / Metal
 Shade: Clear / Acrylic
 Switch: Dual Dimmer Rotary on Pole
 Main Lamp: 18W LED (3000K, 1800lm, CRI: 80)
 Reading Lamp: 5W LED (3000K, 450lm, CRI: 80)
 Features: **Dual Dimmer Switches, Replaceable & Dimmable LED**

LS-83067 ② · Zale 5-Lite LED Arc Lamp

Body: Brushed Nickel / Metal
 Shade: Clear / Acrylic
 Switch: 3-Way Rotary on Pole
 Lamp: 5W LED x5 (3000K, 2300lm, CRI: 80)
 Features: **3-Way Switch, Replaceable & Dimmable LED**

LS-83069 ④ · Zale 4-Lite LED Floor Lamp

Body: Brushed Nickel / Metal
 Shade: Clear / Acrylic
 Switch: On/Off Foot
 Lamp: 5W LED x4 (3000K, 1800lm, CRI: 80)
 Features: **Replaceable & Dimmable LED**



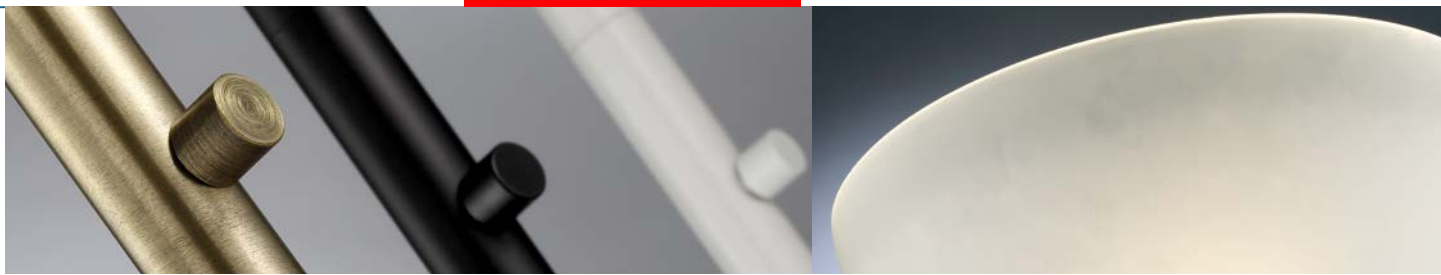

LS-83024AB ① / LS-83024BLK ② / LS-83024BN ③ / LS-83024WHT ④

· Ward Torchiere Lamp

Body: Antique Brass, Black, Brushed Nickel or White / Metal

Shade: Frosted / Glass

Switch: Dimmer Rotary on Pole

Lamp: 30W LED (3000K, 2700lm, CRI: 80)

Features: **Dimmer Switches, Replaceable & Dimmable LED**

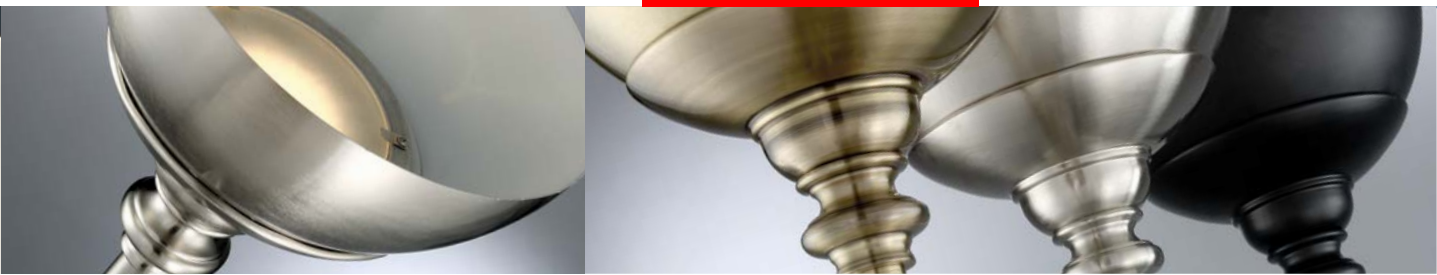

LS-83023AB ① / LS-83023BLK ② / LS-83023BN ③ / LS-83023WHT ④

· Dallon Torchiere Lamp

Body: Antique Brass, Black, Brushed Nickel or White / Metal
 Shade: Frosted / Glass

Switch: Dimmer Rotary on Pole

Lamp: 30W LED (3000K, 2700lm, CRI: 80)

Features: **Dimmer Switches, Replaceable & Dimmable LED**

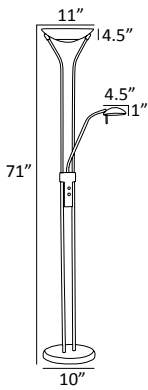

LS-82842AB ① / LS-82842BLK ② / LS-82842PS ③

· Duality III Torchiere/Reading Lamp

Body: Antique Brass, Black or Polished Steel / Metal

Shade: Matching Finish / Metal w. Diffuser

Switch: Dual Dimmer Rotary on Pole

Main Lamp: 18W LED (3000K, 1800lm, CRI: 80)

Reading Lamp: 5W LED (3000K, 360lm, CRI: 80)

Features: **Dual Dimmer Switches, Dimmable LED**

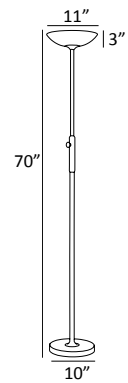
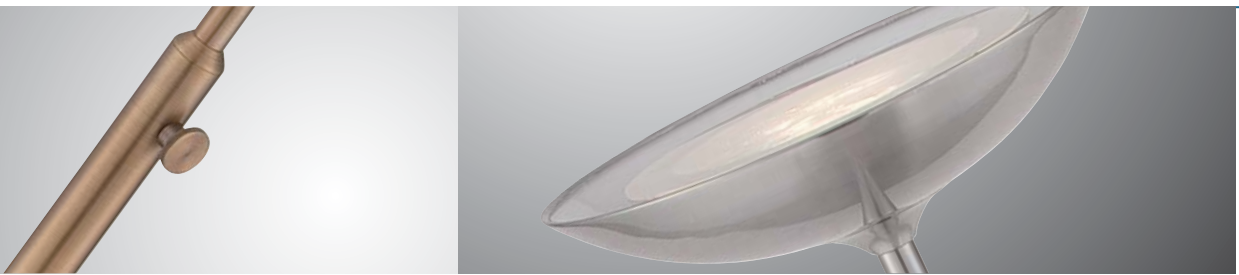

LS-82710AB ① / LS-82710BLK ② / LS-82710PS ③

· Lemuel Torchiere Lamp

Body: Antique Brass, Black or Polished Steel / Metal

Shade: Matching Finish / Metal

Switch: Dimmer Rotary on Pole

Lamp: 40W LED (3000K, 3200lm, CRI: 80)

Features: **Dimmer Switches, Dimmable LED**





LS-83127BN · Balbir Torchiere Lamp

Body: Brushed Nickel / Metal
 Shade: Matching Finish Metal / Clear Acrylic Accent
 Switch: Dimmer Rotary on Pole
 Lamp: 35W GU10 LED Bulb (2700K, 3150lm, CRI: 80)
 Features: **Replaceable & Dimmable LED**

LS-83127G · Balbir Torchiere Lamp

Body: Gunmetal / Metal
 Shade: Matching Finish Metal / Clear Acrylic Accent
 Switch: Dimmer Rotary on Pole
 Lamp: 35W GU10 LED Bulb (2700K, 3150lm, CRI: 80)
 Features: **Replaceable & Dimmable LED**

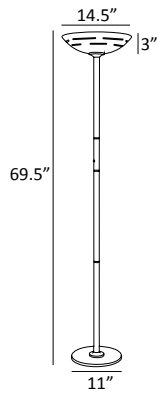

LS-82902BLK · Glison Torchiere Lamp

Body: Black / Metal
Shade: Matching Finish
Switch: Dimmer Rotary on Pole
Lamp: 30W LED (3000K, 2000lm, CRI: 80)
Features: **Dimmer Switch, Dimmable LED**

LS-82902PS · Glison Torchiere Lamp

Body: Polished Steel / Metal
Shade: Matching Finish
Switch: Dimmer Rotary on Pole
Lamp: 30W LED (3000K, 2000lm, CRI: 80)
Features: **Dimmer Switch, Dimmable LED**

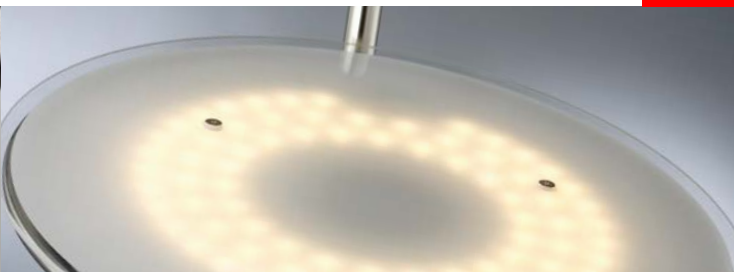

Dual Push-Button Dimmer Switches

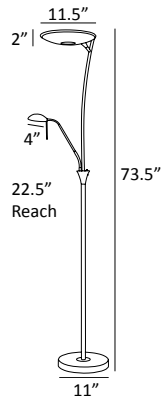

LS-82929BLK/C · Huck Torchiere/Reading Lamp

Body: Black & Chrome / Metal
 Shade: Chrome / Metal
 Switch: Dual Dimmer Push-Button on Pole
 Main Lamp: 40W LED (3000K, 3800lm, CRI: 80)
 Reading Lamp: 7W LED (3000K, 480lm, CRI: 80)
 Features: **Dual Dimmer Switches, Dimmable LED**

LS-82929PS · Huck Torchiere/Reading Lamp

Body: Polished Steel / Metal
 Shade: Polished Steel / Metal
 Switch: Dual Dimmer Push-Button on Pole
 Main Lamp: 40W LED (3000K, 3800lm, CRI: 80)
 Reading Lamp: 7W LED (3000K, 480lm, CRI: 80)
 Features: **Dual Dimmer Switches, Dimmable LED**





LS-16068 ① · Otoniel Wall Sconce

Body: Chrome / Metal
 Shade: Clear / Acrylic
 Lamp: 7W LED Panel (3000K, 500lm, CRI: 80)
 Features: **Dimmable LED, ADA**

LS-18668 ② · Otoniel Pendant

Body: Chrome / Metal
 Shade: Clear / Acrylic
 Lamp: 18W LED Panel (3000K, 1200lm, CRI: 80)
 Features: **Dimmable LED**

LS-22080 ③ · Otoniel Table Lamp

Body: Chrome / Metal
 Shade: Clear / Acrylic
 Switch: On/Off Rocker on Base
 Lamp: 7.2W LED Panel (3000K, 500lm, CRI: 80)

LS-82668 ④ · Otoniel Floor Lamp

Body: Chrome / Metal
 Shade: Clear / Acrylic
 Switch: Touch Dimmer on Pole
 Lamp: 9W LED Panel (3000K, 600lm, CRI: 80)
 Features: **Dimmable LED**

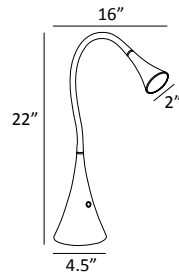
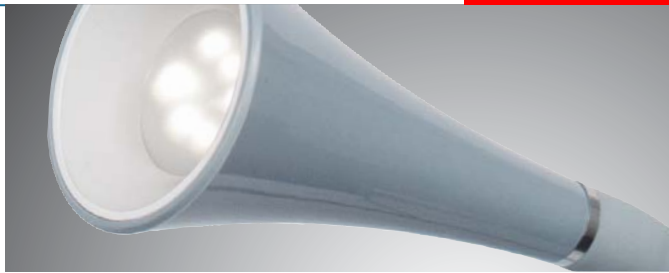

LS-23083BLK ① / LS-23083GREY ② / LS-23083WHT ③

· Xena LED Desk Lamp

Body: Black, Cool Grey or White / PS

Shade: Matching Finish / PS

Switch: Touch Dimmer on Base

Lamp: 3.8W LED (3000K, 300lm, CRI>70)

Features: **Gooseneck, Dimmable LED, USB Charging Port x1**



①



②

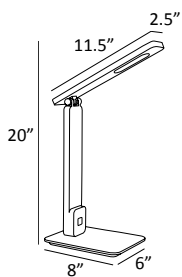

③



LS-23082BLK ① / LS-23082SILV ② / LS-23082WHT ③

· Echo LED Desk Lamp

Body: Black, Silver or White / PS

Shade: Matching Finish / PS

Switch: Touch Dimmer on Base

Lamp: 6.5W LED (3000K, 500lm, CRI>70)

Features: Foldable, Dimmable LED, USB Charging Port x1

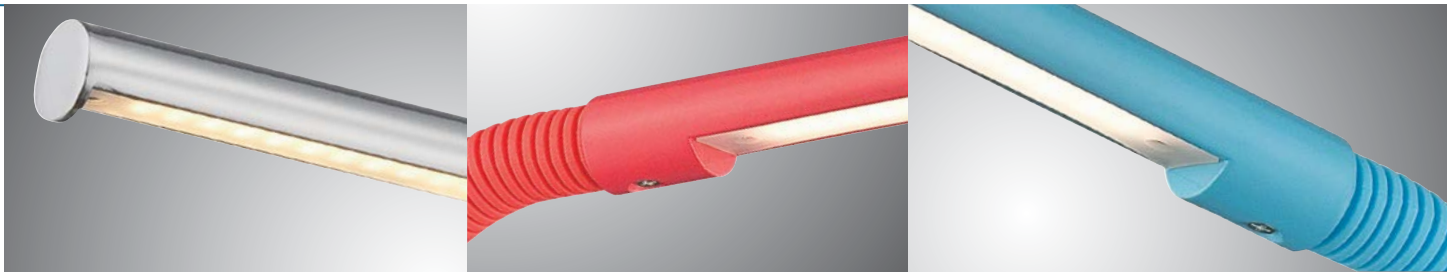

①

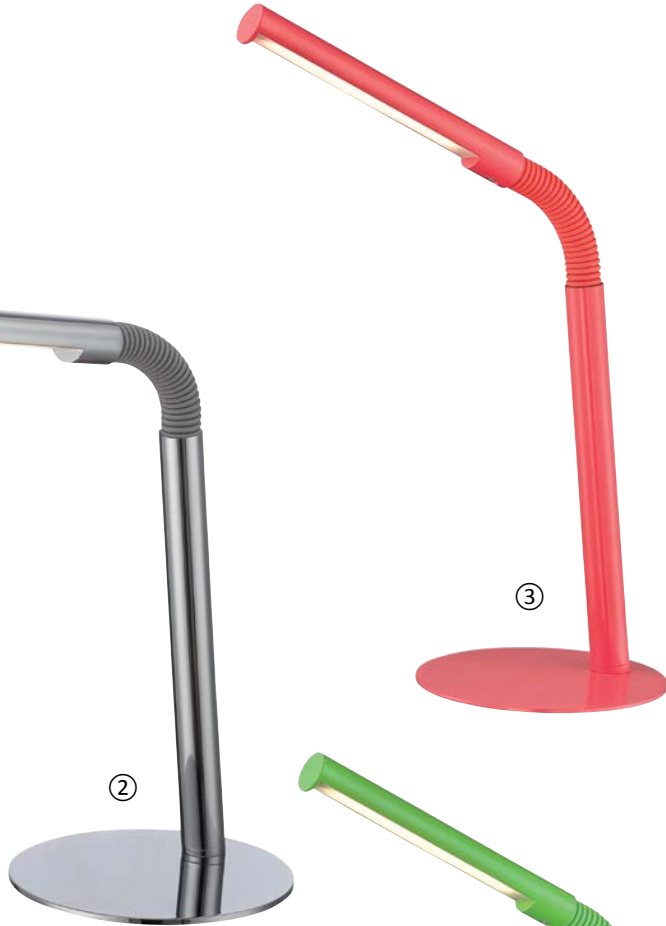

③



②



④

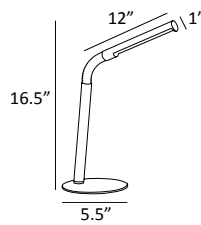

⑤

LS-22339BLK ① / LS-22339C ② / LS-22339H/PINK ③ / LS-22339L/BLU ④ / LS-22339L/GRN ⑤
 · Biagio Desk Lamp
 Body: Black, Chrome, Hot Pink, Light Blue or Light Green / Metal
 Shade: Matching Color / Metal
 Switch: On/Off In-Line
 Lamp: 3W LED (3000K, 180lm, CRI: 80)
 Features: **Gooseneck**



LS-22695BLK ①

LS-22695WHT ② · Java Desk Lamp

Body: Chrome / Metal
 Shade: Black or White / Plastic
 Switch: On/Off Push-Button on Base
 Lamp: 6W LED (3000K, 350lm, CRI: 80)
 Features: **Adjustable Arm & Shade**

LS-22696BLK ③

LS-22696SILV ④ · Galaxy Desk Lamp

Body: Silver or Black / Plastic
 Shade: Black or Silver / Plastic
 Switch: On/Off Push-Button on Pole
 Lamp: 5W LED (3000K, 350lm, CRI: 80)
 Features: **Adjustable Shade**

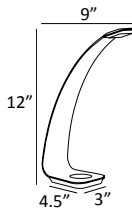
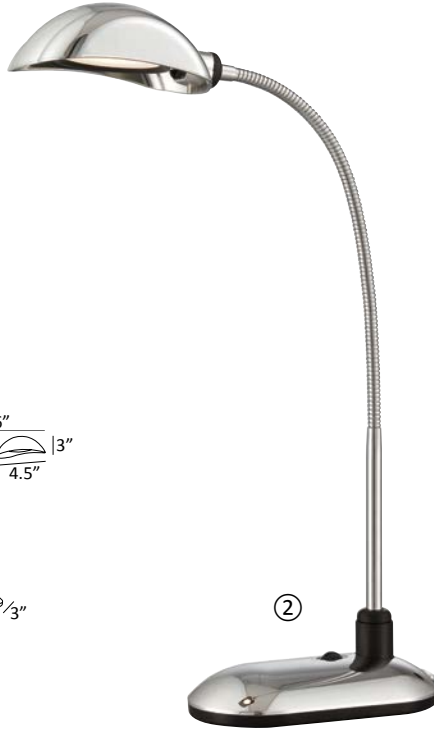
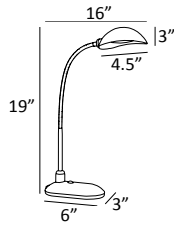
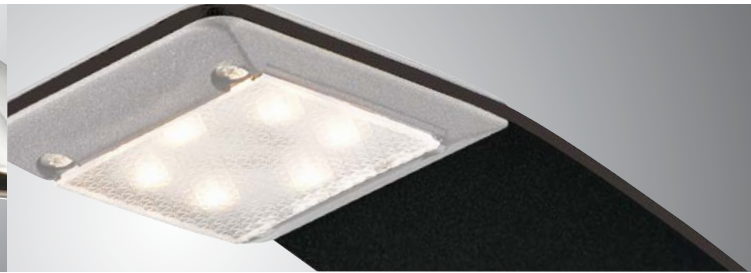

LS-22393BLK ①
LS-22393C ② · Ettore Desk Lamp
 Body: Black or Chrome / Metal
 Shade: Matching Color / Plastic
 Switch: On/Off Push-Button on Base
 Lamp: 3W LED (3000K, 210lm, CRI>82)
 Features: **Gooseneck**

LS-22396BLK ③
LS-22396SILV ④ · Luce Desk Lamp
 Body: Black or Silver / Metal
 Shade: Black or Silver / Metal
 Switch: Touch Dimmer on Base
 Lamp: 3W LED (3000K, 215lm, CRI>80)
 Features: **Touch Dimmer Switch**



LS-306BLK ①

LS-306PS ② · Halotech Desk Lamp

Body: Black or Polished Brass / Metal

Shade: Matching Finish / Metal

Switch: Dimmer on Base

Lamp: 8W LED (3000K, 650lm, CRI>80)

Features: **Dimmer Switch, Dimmable LED, Adjustable Arm & Shade**

LS-22399BLK ③

LS-22399SILV ④ · Donati Desk Lamp

Body: Black Metal / Black or Silver Plastic

Shade: Black or Silver / Plastic

Switch: 4-Way Touch on Base

Lamp: 5.4W LED (4-Way Color Temp., 420lm, CRI>82)

Features: **4-Way Touch Switch, Adjustable Arm & Shade**



①

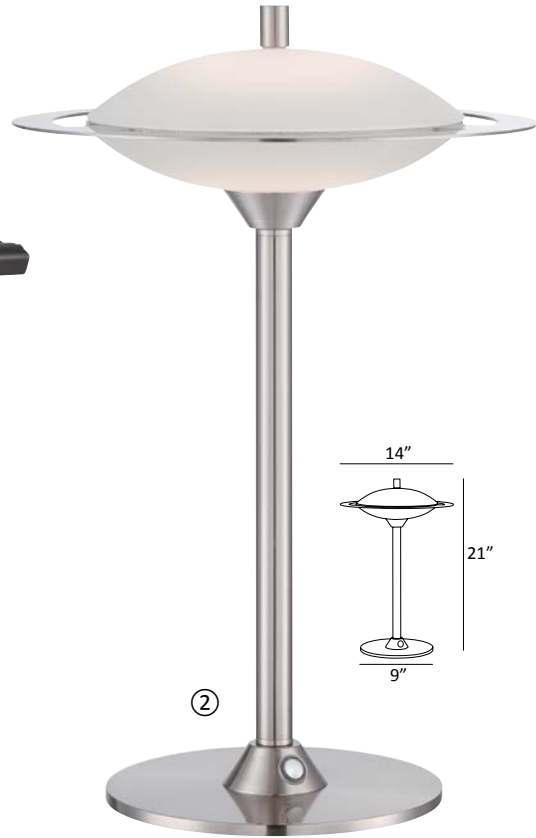

②



③

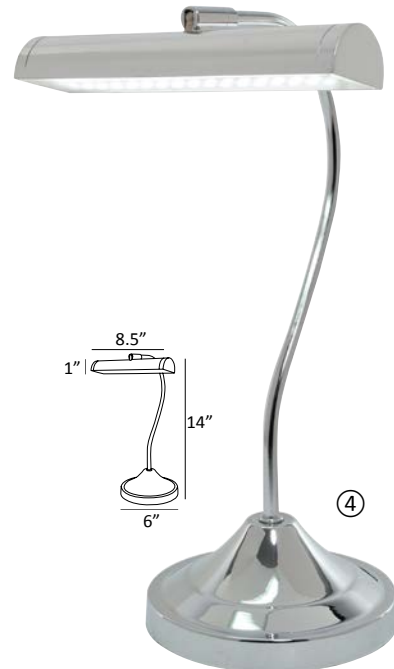

④

LS-22397BLK ① · Lanzo Desk Lamp

Body: Black Metal / Black Plastic
 Shade: Black / Plastic
 Switch: On/Off Push-Button on Base
 Lamp: 3.6W LED (3000K, 230lm, CRI>82)
 Features: **Adjustable Shade**

LS-22477 ② · Obert Table Lamp

Body: Brushed Nickel / Metal
 Shade: Frosted / Glass
 Switch: Touch Dimmer
 Lamp: 12W LED Panel (3000K, 960lm, CRI: 80)
 Features: **Touch Dimmer, Dimmable LED**

LS-22479 ③ · Slate Table Lamp

Body: Silver / Metal
 Shade: Clear Tempered / Glass
 Switch: Touch Dimmer
 Lamp: 8W LED Panel (3000K, 640lm, CRI: 80)
 Features: **Touch Dimmer, Dimmable LED**

LS-22820C ④ · Cady Desk Lamp

Body: Chrome / Metal
 Shade: Chrome / Plastic
 Switch: On/Off In-Line
 Lamp: 7W LED (3000K, 420lm, CR>80)
 Features: **Adjustable Shade**

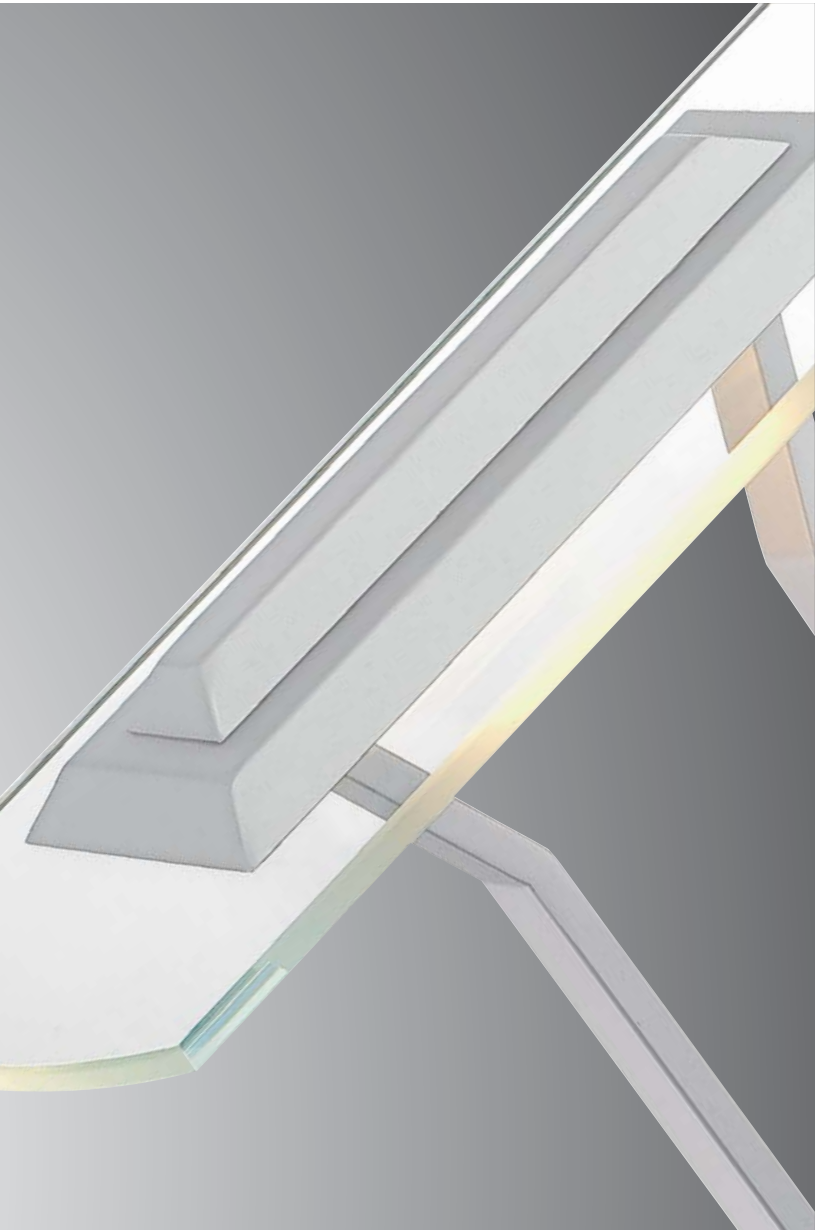

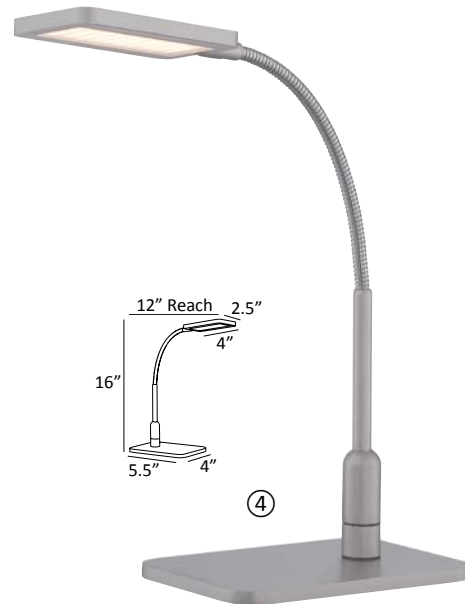
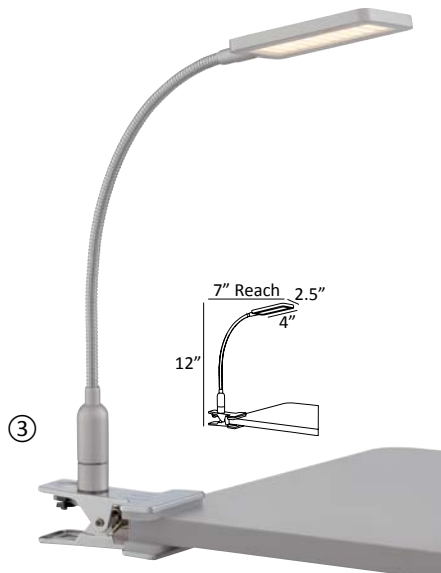
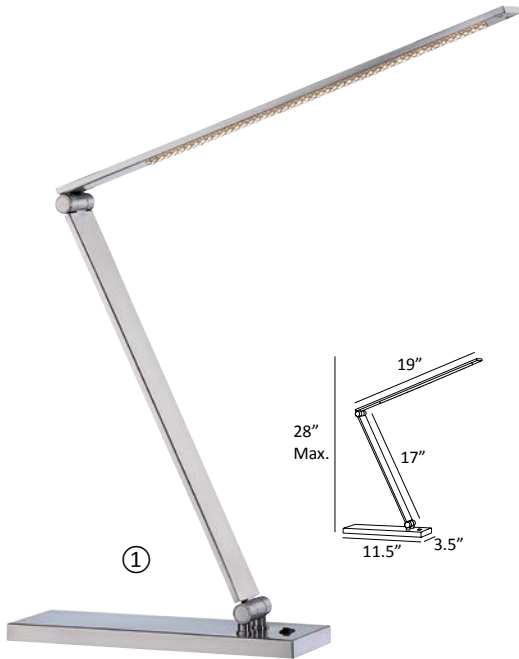

LS-21478PS ① · Sloane II Desk Lamp

Body: Polished Steel / Metal
 Shade: Polished Steel / Metal
 Switch: On/Off Rocker on Base
 Lamp: 5.76W LED (3000K, 400lm, CRI: 80)
 Features: **Adjustable Arm**

LS-22292 ② · Luke II Desk Lamp

Body: Chrome Metal / Black Tempered Glass
 Shade: Chrome Metal / Clearrylic Diffuser
 Switch: Touch Dimmer on Base
 Lamp: 4.5W LED (3000K, 400lm, CRI>80)
 Features: **Adjustable Arm & Shade**

LS-22804 ③ · Gordy Clip-On Lamp

Body: Satin Nickel / Metal
 Shade: Satin Nickel / Metal
 Switch: On/Off In-Line
 Lamp: 6W LED (3000K, 480lm, CRI: 80)
 Features: **Gooseneck**

LS-22805 ④ · Gordy Desk Lamp

Body: Satin Nickel / Metal
 Shade: Satin Nickel / Metal
 Switch: On/Off Touch on Pole
 Lamp: 6W LED (3000K, 480lm, CRI: 80)
 Features: **LED Included, Gooseneck**

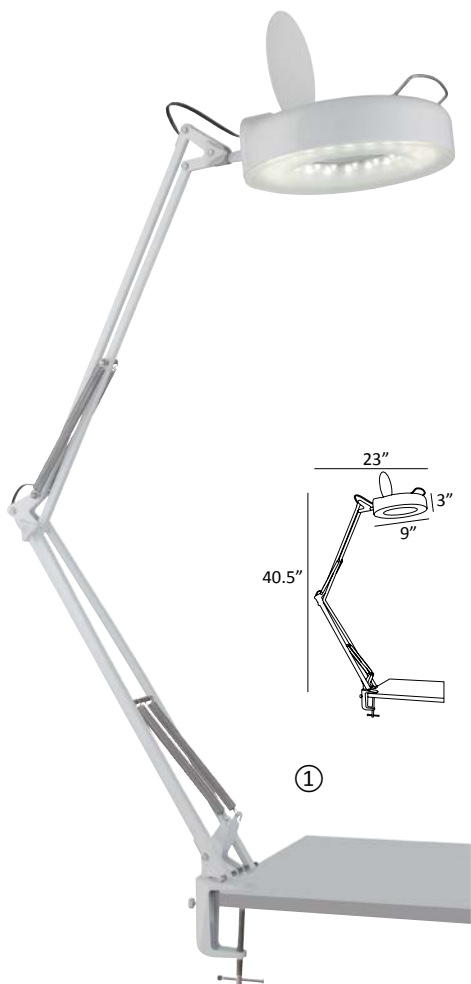

①



②



③

LSM-180LED/BLK ①

LSM-180LED/WHT ② · Magnify-Lite Magnifier Desk Lamp

Body: Black or White / Metal
 Shade: Matching Finish / Metal
 Switch: On/Off Rocker on Shade
 Lamp: 9.4W LED (4500K, 530lm, CRI>80)
 Features: **Replaceable LED, 3-Diopter Magnifier, Adjustable Arm & Shade, Clamp-On**

LSM-199SILV ③ · Mara Magnifier Desk Lamp

Body: Silver / Metal
 Shade: Silver / Metal
 Switch: On/Off Rocker on Pole
 Lamp: 5.4W LED (3000K, 415lm, CRI>82)
 Features: **Replaceable LED, 2-Diopter Magnifier, Adjustable Arm & Shade**

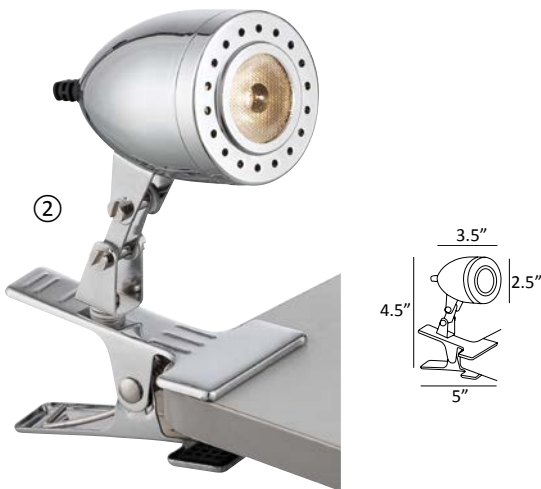
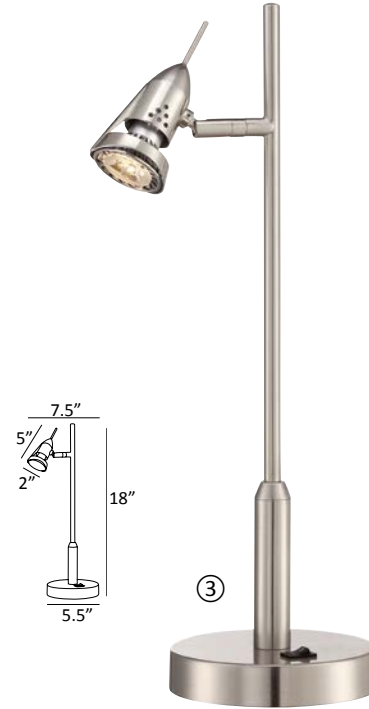
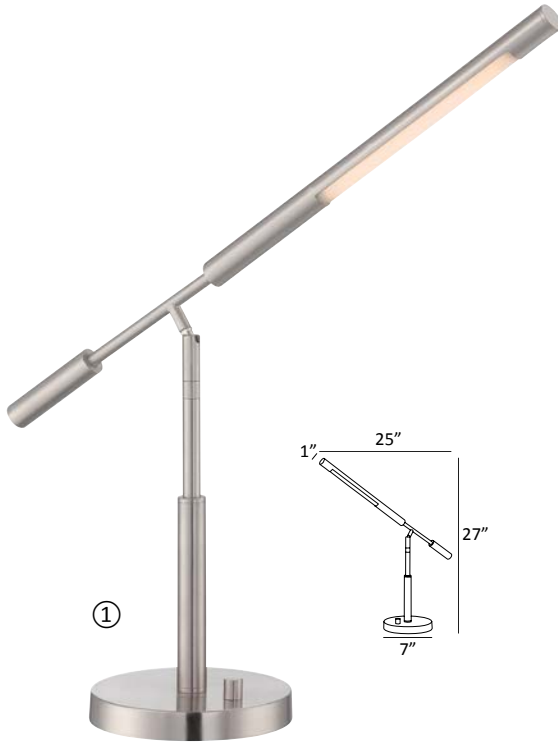

LS-21719PS ① · Cayden II Desk Lamp

Body: Polished Steel / Metal
 Shade: Polished Steel / Metal
 Switch: On/Off Rotary on Base
 Lamp: 4.2W LED (3000K, 400lm, CRI: 80)
 Features: **Adjustable Arm**

LS-22464PS ③ · Laszlo Desk/Table Lamp

Body: Polished Steel / Metal
 Shade: Polished Steel / Metal
 Switch: On/Off Rocker on Base
 Lamp: 4W GU10 LED Bulb (3000K, 400lm, CRI>80)
 Features: **Replacable LED Bulb, Adjustable Shade**

LS-22324C ② · Niko Clip-On Lamp

Body: Chrome / Metal
 Shade: Chrome / Metal
 Switch: On/Off In-Line
 Lamp: 5W LED (3000K, 120lm, CRI: 80)
 Features: **Adjustable Shade, Clip-On**

LS-22680PS ④ · Nobu Clip-On Lamp

Body: Polished Steel / Metal
 Shade: Polished Steel / Metal
 Switch: On/Off In-Line
 Lamp: 5W LED (3000K, 330lm, CRI: 80)
 Features: **Gooseneck, Clip-On**

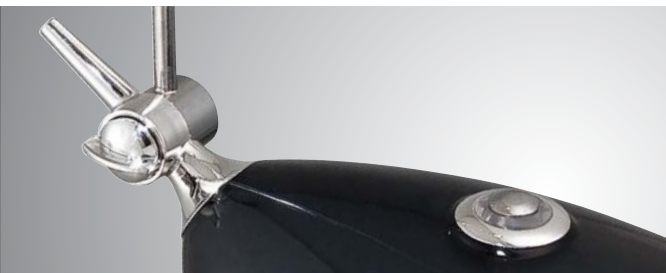

ERMETE
GEONNA
GALTEM
CALLA

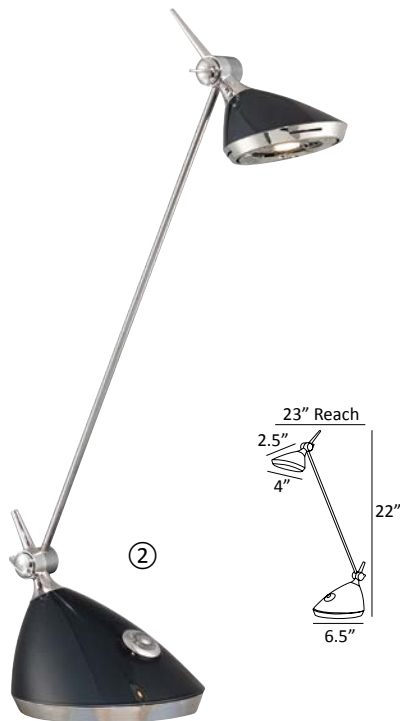
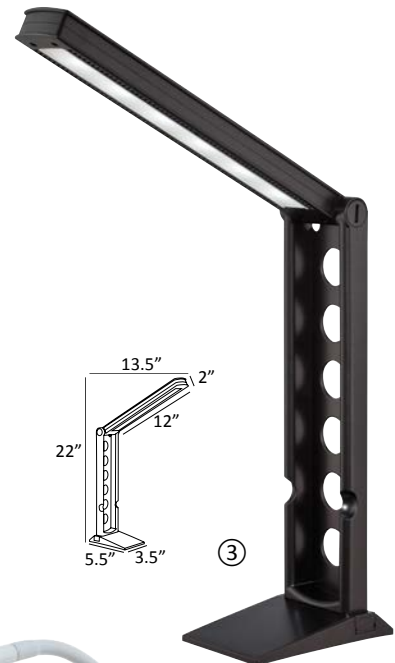
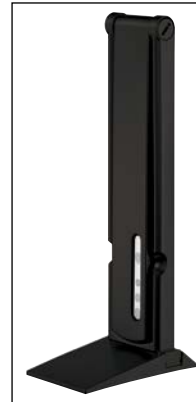

LS-22048SILV ① · Ermete Desk Lamp

Body: Black Metal / Silver Plastic
Shade: Silver / Plastic
Switch: On/Off on Base
Lamp: 3.6W LED (6000K, 252lm, CRI>82)
Features: **True Daylight, Gooseneck**

LS-22400BLK ③ · Galtem Desk Lamp

Body: Black or Silver / Plastic
Shade: Matching Color Plastic / Frosted Diffuser
Switch: 3-Way Touch Dimmer on Shade
Lamp: 6W LED (4800K, 445lm, CR>82)
Features: **True Daylight, Foldable**

LS-22394BLK ② · Geonna Desk Lamp

Body: Chrome Metal / Black Plastic
Shade: Black / Plastic
Switch: Touch Dimmer on Base
Lamp: 5.4W LED (3000K, 430lm, CR>82)
Features: **Touch Dimmer Switch, Adjustable Arm & Shade**

LS-22823WHT ④ · Calla Desk Lamp

Body: White / Plastic
Shade: White / Plastic
Switch: 4-Way Touch Dimmer on Base
Lamp: 5W LED (3000K, 420lm, CRI>80)
Features: **4-Way Touch Dimmer Switch, Gooseneck**

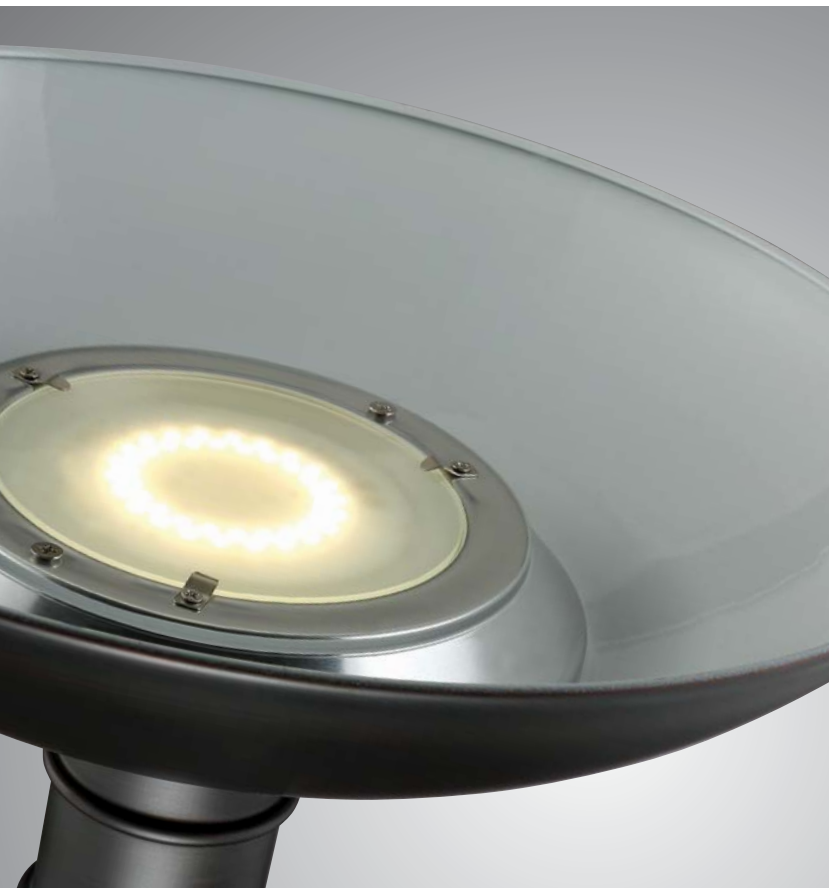



①



②



③

LS-82933 ① · Malibu Torchiere Lamp

Body: Dark Bronze & Copper / Metal
 Shade: Dark Bronze / Metal
 Switch: Dimmer Rotary on Pole
 Lamp: 30W LED (3000K, 1650lm, CRI: 80)
 Features: **Dimmable LED Included**

LS-82934 ② · Ralston Torchiere Lamp

Body: Antique Black / Metal
 Shade: Cloud / Glass
 Switch: Dimmer Rotary on Pole
 Lamp: 30W LED (3000K, 2700lm, CRI: 80)
 Features: **Dimmable & Replaceable LED Included, Marble Accent**

LS-83026D/BRZ ③ · Stafford Torchiere Lamp

Body: Dark Bronze / Metal
 Shade: Frosted / Glass
 Switch: Dimmer Rotary on Pole
 Lamp: 30W LED (3000K, 2700lm, CRI: 80)
 Features: **Dimmable & Replaceable LED Included**

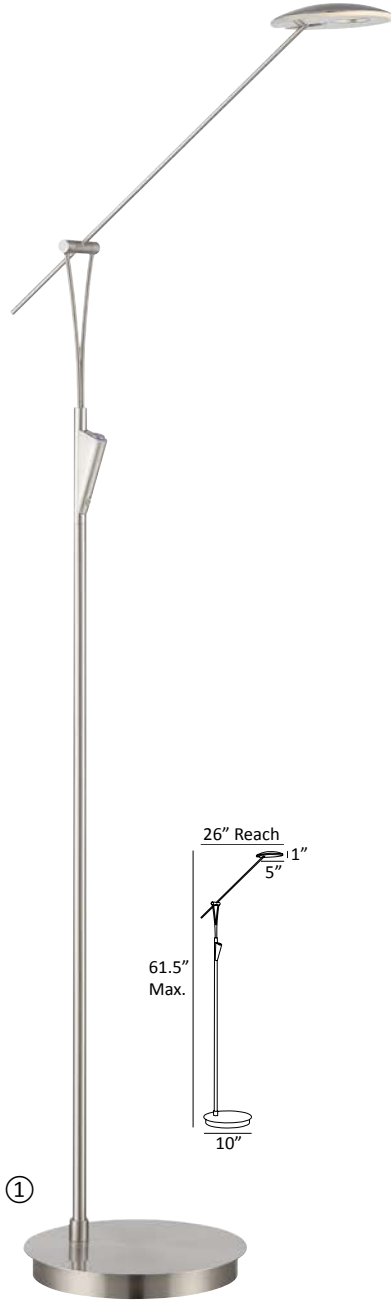
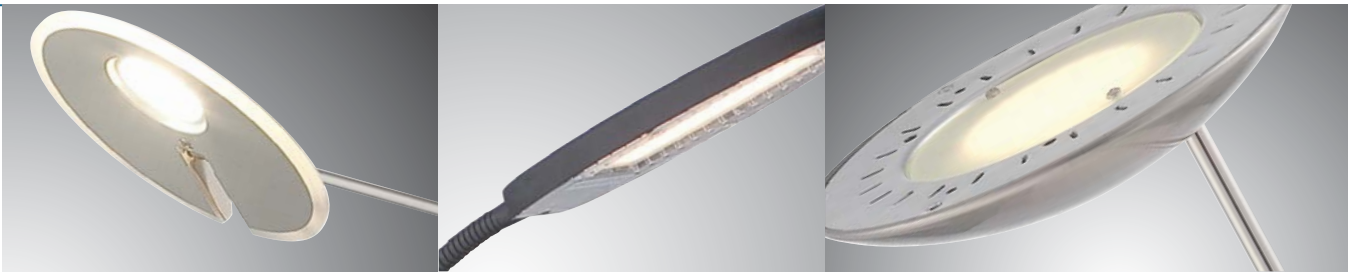

①



②



③

LS-82329 ① · Kamana Floor Lamp

Body: Satin Chrome / Metal
Shade: Satin Chrome / Metal
Switch: On/Off Touch on Pole
Lamp: 7W LED (4000K, 480lm, CR>80)
Features: **Adjustable Arm & Shade**

LS-82488BLK ② · Kairi Floor Lamp

Body: Matte Black / Metal
Shade: Matching Finish Metal / Clear Diffuser
Switch: On/Off Touch
Lamp: 12W LED Panel (3000K, 1100lm, CRI: 80)
Features: **Gooseneck**

LS-82632PS ③ · Taran Torchiere Lamp

Body: Polished Steel / Metal
Shade: Polished Steel Metal / Frosted Diffuser
Switch: Push-Button Dimmer on Pole
Lamp: 30W LED (3000K, 1650lm, CRI: 80)
Features: **Dimmable LED Included**



LS-82633PS ① · Taurus Torchiere Lamp

Body: Polished Steel / Metal
 Shade: Frosted / Glass
 Switch: Push-Button Dimmer on Pole
 Lamp: 30W LED (3000K, 1650lm, CRI: 80)
 Features: **Dimmable LED Included**

LS-82931 ② · Edith Torchiere Lamp

Body: Brushed Nickel / Metal
 Shade: Frosted / Glass
 Switch: Dimmer Rotary on Pole
 Lamp: 30W LED (3000K, 1650lm, CRI: 80)
 Features: **Dimmable LED Included**

LS-82936 ③ · Natalia Torchiere/Reading Lamp

Body: Brushed Nickel / Metal
 Shade: Frosted / Glass
 Switch: Dual Dimmer Rotary on Pole
 Main Lamp: 30W LED (3000K, 2700lm, CRI: 80)
 Reading Lamp: 5W LED (3000K, 450lm, CRI: 80)
 Features: **Dimmable & Replaceable LED Included**





LS-81455AB · Lanterna Floor Lamp

Body: Antique Bronze / Metal
 Shade: Antique Bronze Metal / Frosted Glass
 Switch: On/Off Foot
 Lamp: E-27 Medium Base (Max. 60W)
 Features: **Double-Layer Shade**

LS-21455AB · Lanterna Table Lamp

Body: Antique Bronze / Metal
 Shade: Antique Bronze Metal / Frosted Glass
 Switch: On/Off In-Line
 Lamp: E-27 Medium Base (Max. 60W)
 Features: **Double-Layer Shade**

LS-81457D/BRZ · Lanterna II 3-Lite Arc Lamp

Body: Dark Bronze / Metal
 Shade: Dark Bronze / Metal
 Switch: 3-Way Rotary on Pole
 Lamp: E-27 Medium Base (Max. 60W) x3
 Features: **3-Way Switch, Vintage Edison Bulb Included**

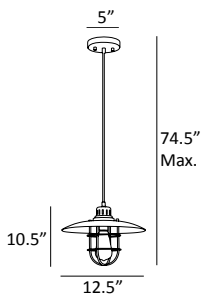
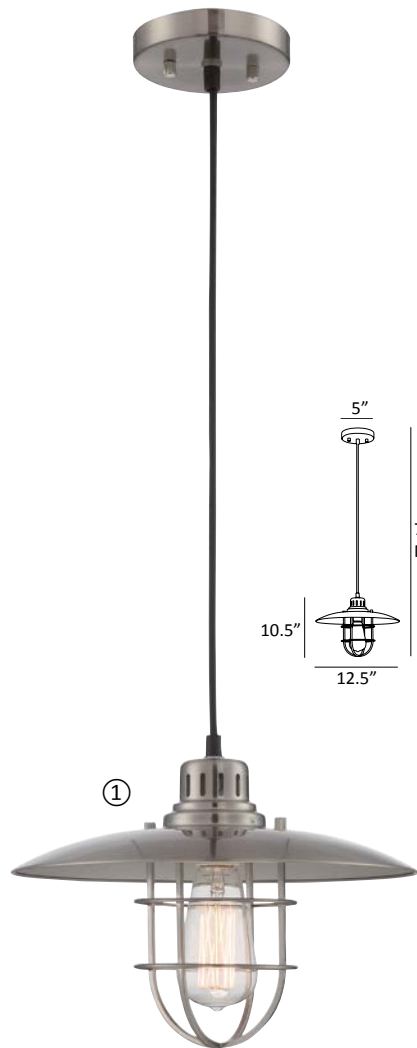

①

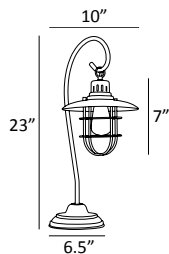

②

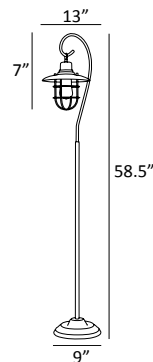
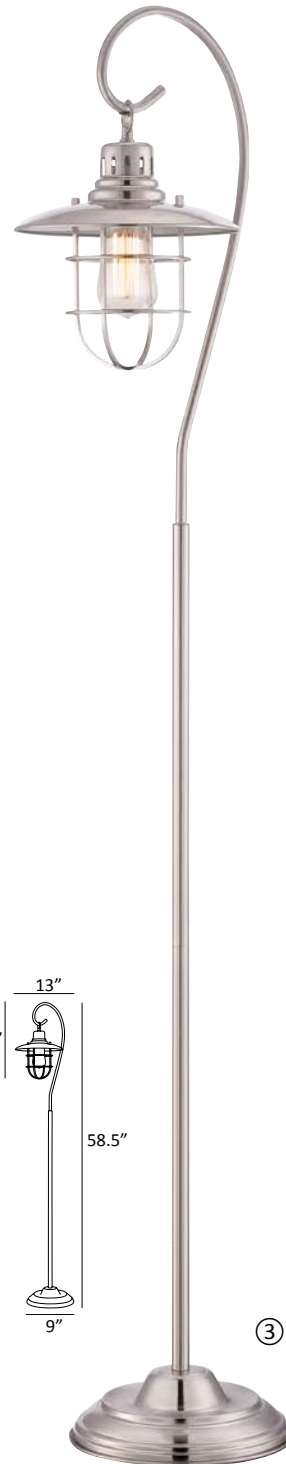

③

LS-18456PS ① · Lanterna II Pendant
 Body: Polished Steel / Metal
 Shade: Polished Steel / Metal
 Lamp: E-27 Medium Base (Max. 75W)
 Features: **Vintage Edison Bulb Included, Adjustable Height**

LS-21456PS ② · Lanterna II Table Lamp
 Body: Polished Steel / Metal
 Shade: Polished Steel / Metal
 Switch: On/Off In-Line
 Lamp: E-27 Medium Base (Max. 60W)
 Features: **Vintage Edison Bulb Included**

LS-81456PS ③ · Lanterna II Floor Lamp
 Body: Polished Steel / Metal
 Shade: Polished Steel / Metal
 Switch: On/Off Foot
 Lamp: E-27 Medium Base (Max. 60W)
 Features: **Vintage Edison Bulb Included**



LS-16456D/BRZ ① · Lanterna II Wall Lamp

Body: Dark Bronze / Metal
 Shade: Dark Bronze / Metal
 Lamp: E-27 Medium Base (Max. 60W)
 Features: **Vintage Edison Bulb Included**

LS-18456D/BRZ ② · Lanterna II Pendant

Body: Dark Bronze / Metal
 Shade: Dark Bronze / Metal
 Lamp: E-27 Medium Base (Max. 75W)
 Features: **Vintage Edison Bulb Included, Adjustable Height**

LS-21456D/BRZ ③ · Lanterna II Table Lamp

Body: Dark Bronze / Metal
 Shade: Dark Bronze / Metal
 Switch: On/Off In-Line
 Lamp: E-27 Medium Base (Max. 60W)
 Features: **Vintage Edison Bulb Included**

LS-81456D/BRZ ④ · Lanterna II Floor Lamp

Body: Dark Bronze / Metal
 Shade: Dark Bronze / Metal
 Switch: On/Off Foot
 Lamp: E-27 Medium Base (Max. 60W)
 Features: **Vintage Edison Bulb Included**

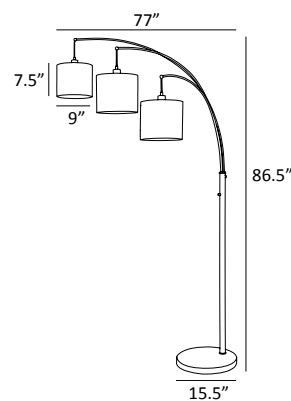
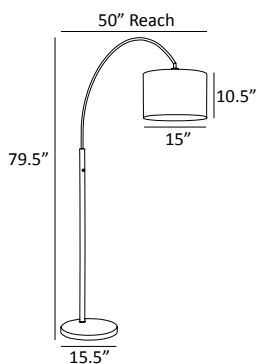

LS-83018 · Hamilton Arc Floor Lamp

Body: Black / Metal
 Shade: Black / Metal
 Switch: On/Off Rotary on Pole
 Lamp: E-27 Medium Base (Max. 75W)
 Features: **75W Vintage Edison Bulb Included**

LS-83019 · Hamilton 3-Lite Arc Floor Lamp

Body: Black / Metal
 Shade: Black / Metal
 Switch: 3-Way Rotary on Pole
 Lamp: E-27 Medium Base (Max. 40W) x3
 Features: **3-Way Switch, 40W Vintage Edison Bulbs Included**

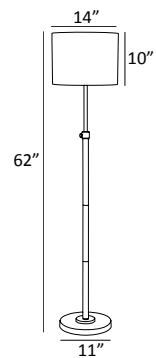
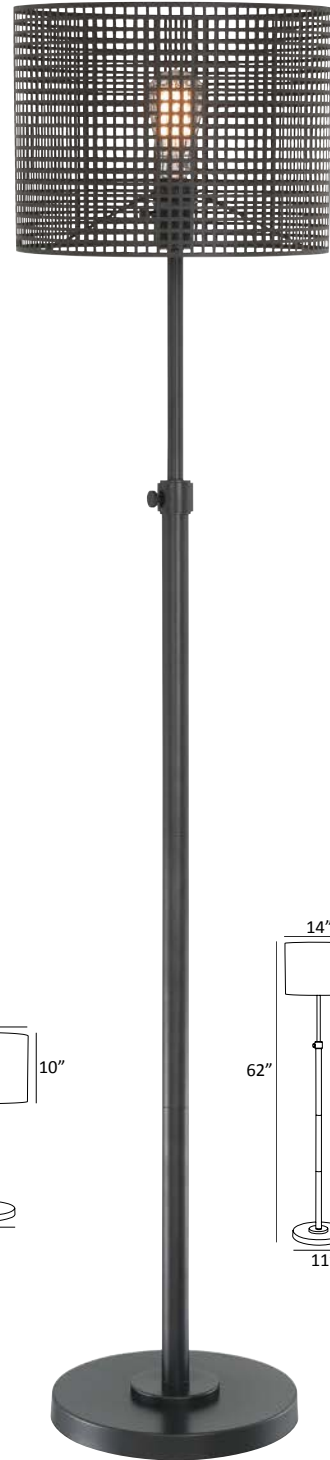
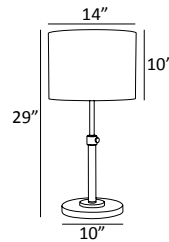
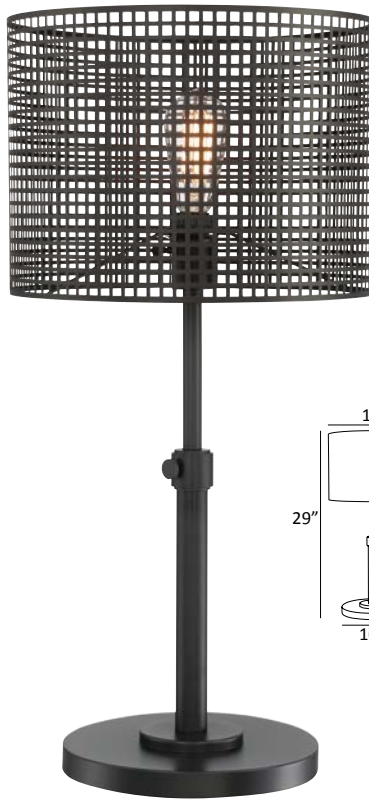
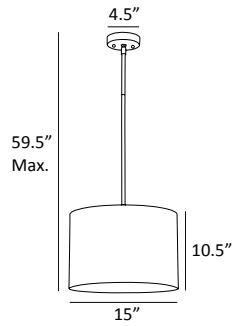
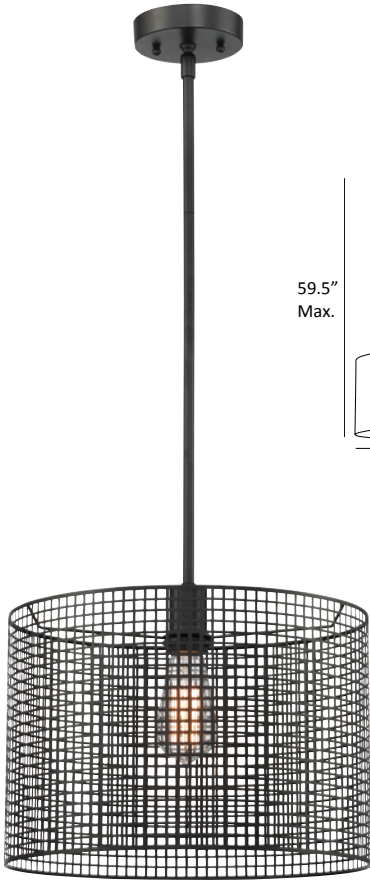

LS-19017 · Hamilton Pendant

Body: Black / Metal
 Shade: Black / Metal
 Lamp: E-27 Medium Base
 Features: **75W Vintage Edison Bulb Included**

LS-23017 · Hamilton Table Lamp

Body: Black / Metal
 Shade: Black / Metal
 Switch: On/Off Socket
 Lamp: E-27 Medium Base (Max. 60W)
 Features: **60W Vintage Edison Bulb Included**

LS-83017 · Hamilton Floor Lamp

Body: Black / Metal
 Shade: Black / Metal
 Switch: On/Off Socket
 Lamp: E-27 Medium Base (Max. 60W)
 Features: **60W Vintage Edison Bulb Included**

KADEN

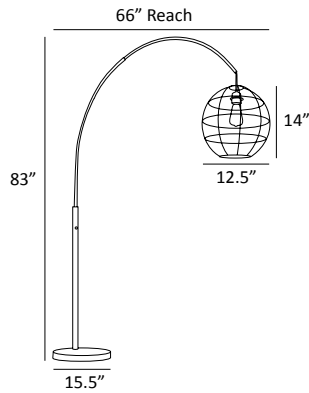
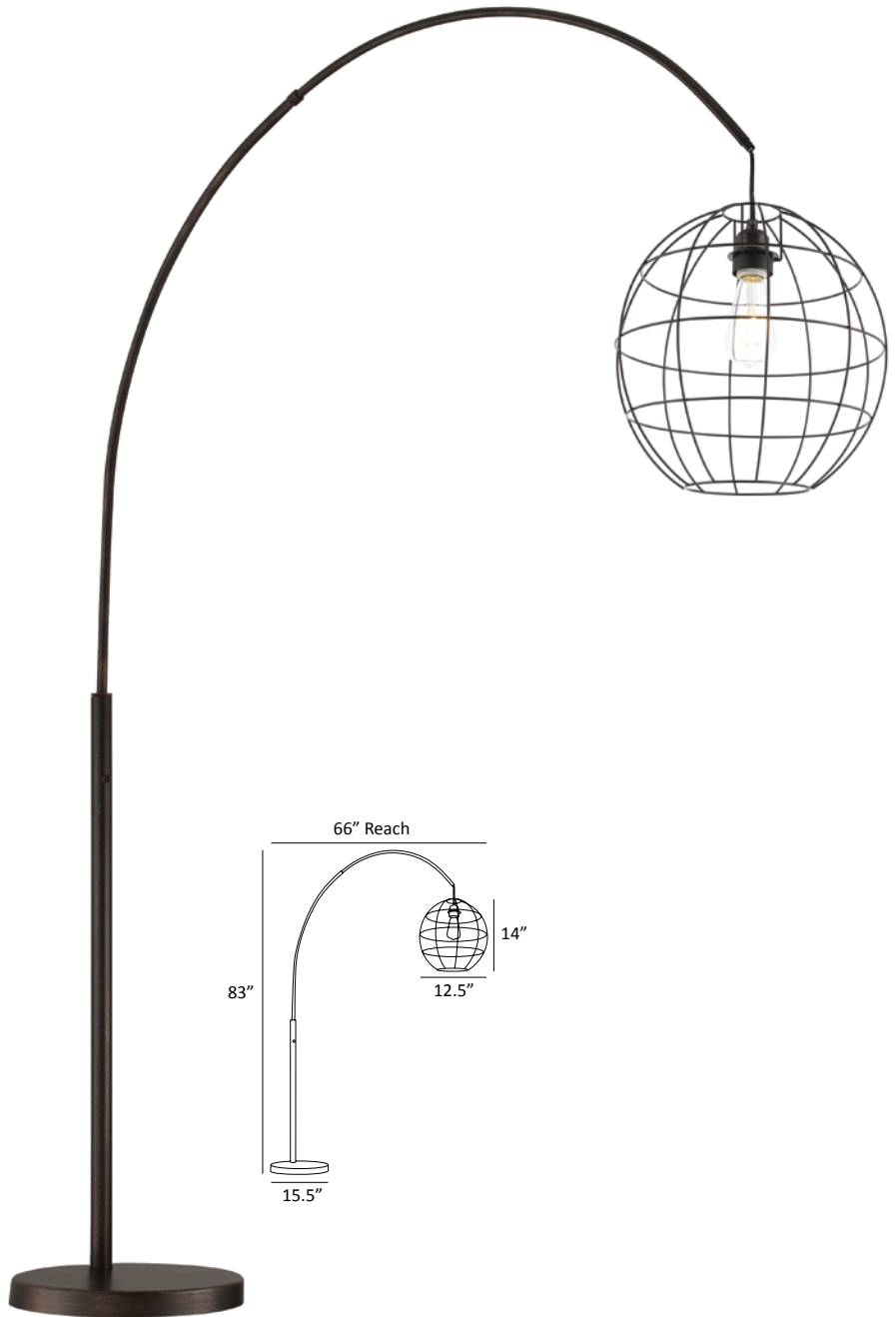
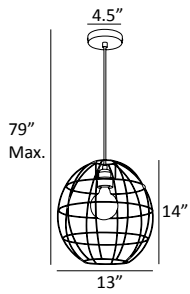

RUSTIC & INDUSTRIAL

LS-19791V · Kaden Pendant

Body: Copper Bronze / Metal
Shade: Copper Bronze / Metal
Lamp: E-27 Medium Base (Max. 60W)
Features: **Vintage Edison Bulb Included**

LS-82791V · Kaden Arc Floor Lamp

Body: Copper Bronze / Metal
Shade: Copper Bronze / Metal
Switch: On/Off Rotary on Pole
Lamp: E-27 Medium Base (Max. 60W)
Features: **Vintage Edison Bulb Included**



LS-82793V · Kaden 3-Light Arc Floor Lamp

Body: Copper Bronze / Metal
 Shade: Copper Bronze / Metal
 Switch: 3-Way Rotary on Pole
 Lamp: E-27 Medium Base (Max. 40W) x3
 Features: **3-Way Switch, Vintage Edison Bulbs Included**

LS-82795V · Kaden 5-Lite Arc Floor Lamp

Body: Copper Bronze / Metal
 Shade: Copper Bronze / Metal
 Switch: 3-Way Rotary on Pole
 Lamp: E-27 Medium Base (Max. 40W) x5
 Features: **3-Way Switch, Vintage Edison Bulbs Included**



LS-22337 · Trey Table Lamp
 Body: Black Wood / Chrome Metal
 Shade: Chrome Metal / Frosted Glass Diffuser
 Switch: On/Off In-Line
 Lamp: E-27 Medium Base (Max. 60W)
 Features: **Adjustable Tri-pod**

LS-82337 · Trey Floor Lamp
 Body: Black Wood / Chrome Metal
 Shade: Chrome Metal / Frosted Glass Diffuser
 Switch: On/Off Foot
 Lamp: E-27 Medium Base (Max. 60W)
 Features: **Adjustable Tri-pod**

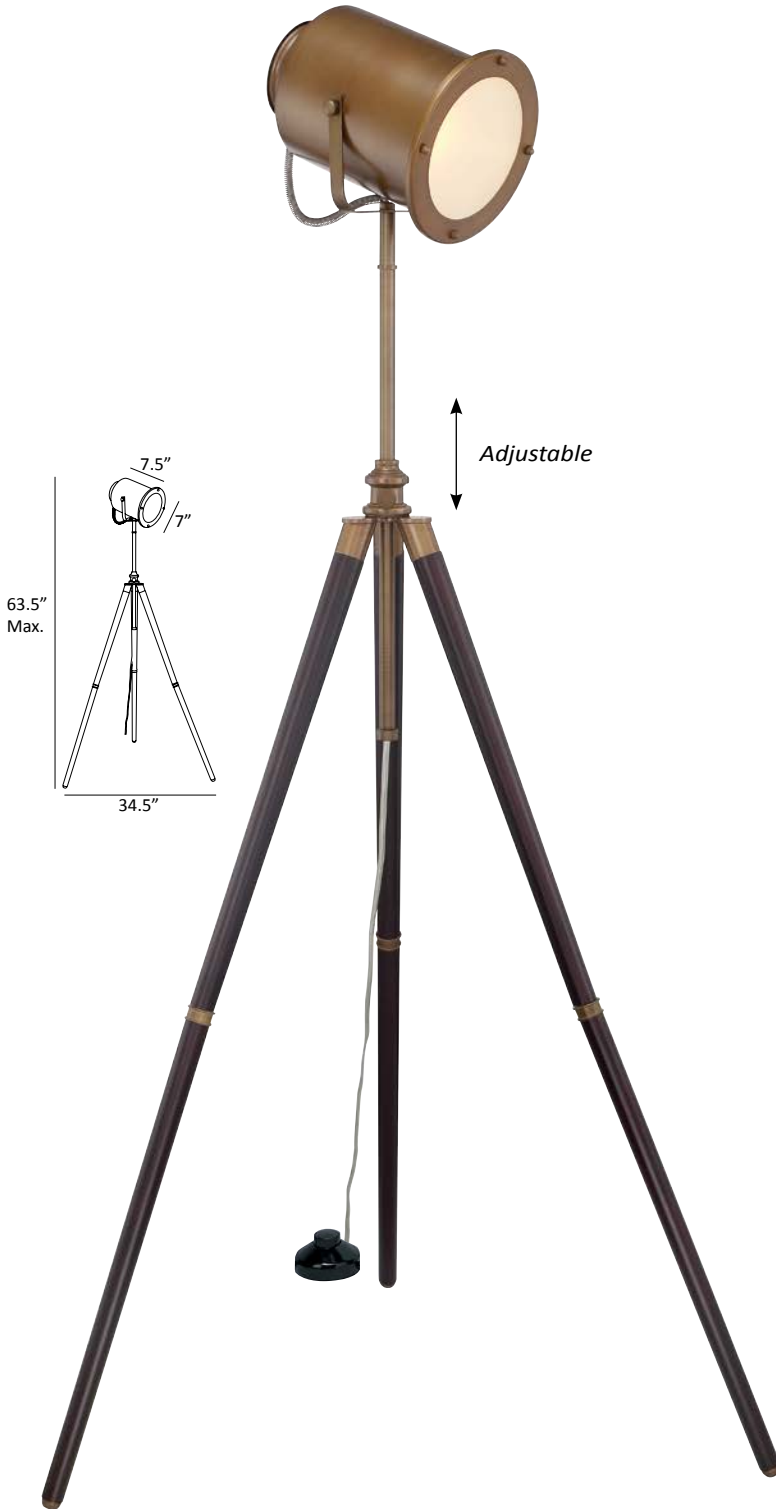

LS-82940 · Saga Floor Lamp

Body: Walnut Wood / Brass Metal
 Shade: Brass Metal / Frosted Glass Diffuser
 Switch: On/Off Foot
 Lamp: E-27 Medium Base (Max. 100W)
 Features: **Adjustable Tri-pod**

LS-22940 · Saga Table Lamp

Body: Walnut Wood / Brass Metal
 Shade: Brass Metal / Frosted Glass Diffuser
 Switch: On/Off In-Line
 Lamp: E-27 Medium Base (Max. 100W)
 Features: **Adjustable Tri-pod**





LS-22604 ① · Cupola Table Lamp

Body: Brushed Brass / Metal
 Shade: Brushed Brass / Metal
 Switch: On/Off Rotary on Shade
 Lamp: E-27 Medium Base (Max. 100W)
 Features: **Adjustable Arm & Shade**

LS-82604 ② · Cupola Floor Lamp

Body: Brushed Brass / Metal
 Shade: Brushed Brass / Metal
 Switch: On/Off Rotary on Shade
 Lamp: E-27 Medium Base (Max. 100W)
 Features: **Adjustable Arm & Shade**

LS-82605 ③ · Cupola 2-Lite Floor Lamp

Body: Brushed Brass / Metal
 Shade: Brushed Brass / Metal
 Switch: On/Off Rotary on Shade
 BLamp: E-27 Medium Base (Max. 100W) x2
 Features: **Adjustable Arms & Shades**

CUPOLA

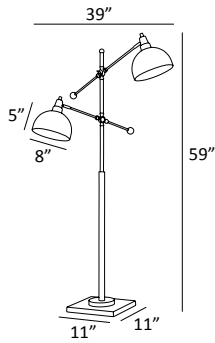

RUSTIC & INDUSTRIAL

LS-82605BN · Cupola 2-Lite Floor Lamp

Body: Brushed Nickel / Metal
 Shade: Brushed Nickel / Metal
 Switch: On/Off Rotary on Shade
 BLamp: E-27 Medium Base (Max. 100W) x2
 Features: **Adjustable Arms & Shades**

LS-82605D/BRZ · Cupola 2-Lite Floor Lamp

Body: Dark Bronze / Metal
 Shade: Dark Bronze / Metal
 Switch: On/Off Rotary on Shade
 BLamp: E-27 Medium Base (Max. 100W) x2
 Features: **Adjustable Arms & Shades**

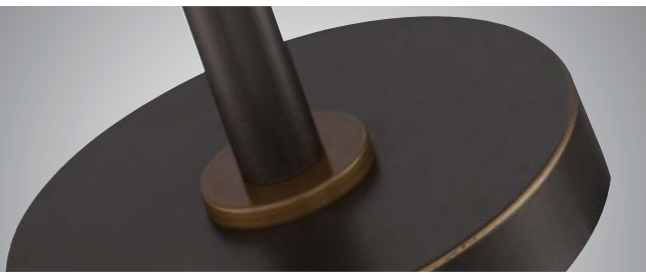

LS-22783 · Najinca Table Lamp

Body: Dark Bronze / Metal
 Shade: Dark Bronze / Metal
 Switch: On/Off In-Line
 Lamp: E-27 Medium Base (Max. 60W)
 Features: **Adjustable Height, Arm & Shade**

LS-82783 · Najinca Floor Lamp

Body: Dark Bronze / Metal
 Shade: Dark Bronze / Metal
 Switch: On/Off Foot
 Lamp: E-27 Medium Base (Max. 60W)
 Features: **Adjustable Height, Arm & Shade**

GEORGINO

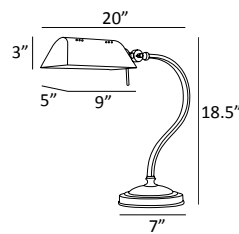
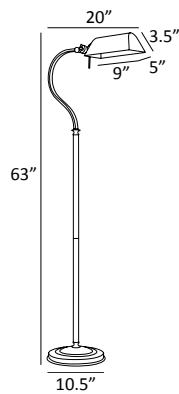

RUSTIC & INDUSTRIAL

LS-82830 · Georgino Floor Lamp

Body: Chrome / Metal
Shade: Chrome / Metal
Switch: On/Off Foot
Lamp: E-27 Medium Base (Max. 100W)
Features: **Adjustable Shade**

LS-22830 · Georgino Table Lamp

Body: Chrome / Metal
Shade: Chrome / Metal
Switch: On/Off In-Line
Lamp: E-27 Medium Base (Max. 60W)
Features: **Adjustable Shade**

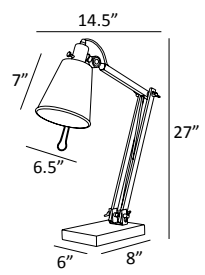
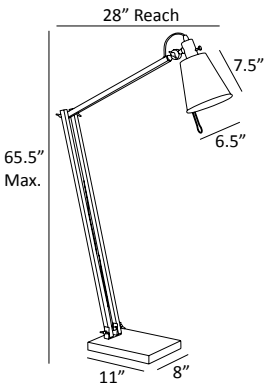

LS-82828 · Pisces Floor Lamp
 Body: Walnut Wood / Black Metal
 Shade: Black / Metal
 Switch: On/Off Socket
 Lamp: E-27 Medium Base (Max. 100W)
 Features: **Adjustable Arm & Shade**

LS-22828 · Pisces Table Lamp
 Body: Walnut Wood / Black Metal
 Shade: Black / Metal
 Switch: On/Off Socket
 Lamp: E-27 Medium Base (Max. 100W)
 Features: **Adjustable Arm & Shade**

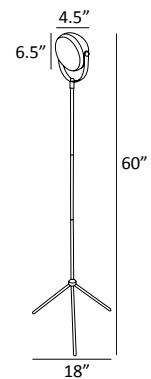
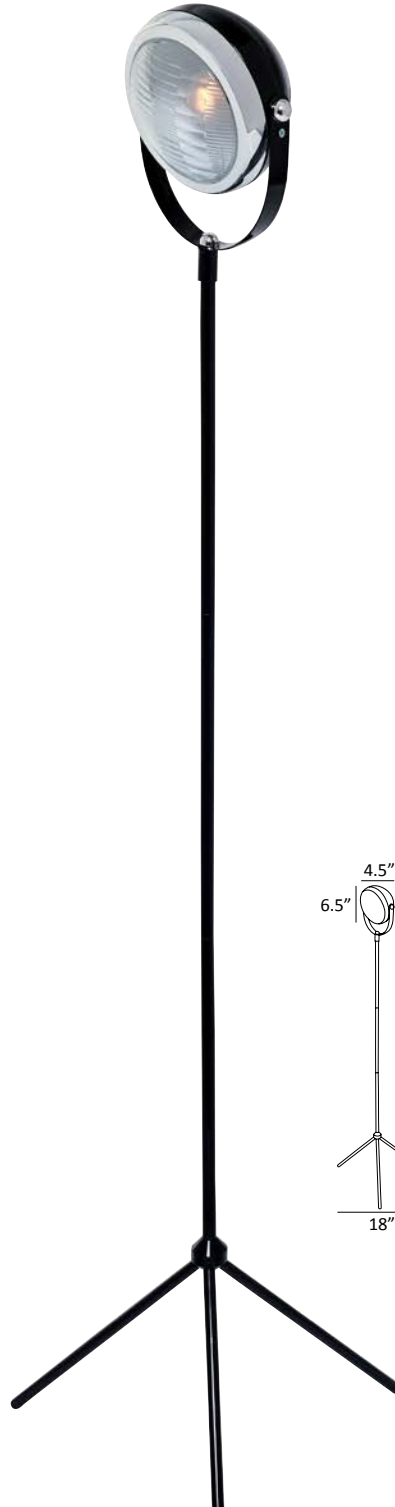
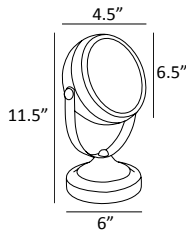

LS-22737BLK · Headlite Table Lamp

Body: Black / Metal
 Shade: Black & Chrome Metal / Grid Glass Diffuser
 Switch: On/Off In-Line
 Bulb Base: E-27 Medium Base (Max. 43W)
 Features: **Halogen Bulb Included, Adjustable Shade**

LS-82737BLK · Headlite Floor Lamp

Body: Black / Metal
 Shade: Black & Chrome Metal / Grid Glass Diffuser
 Switch: On/Off In-Line
 Bulb Base: E-27 Medium Base (Max. 43W)
 Features: **Halogen Bulb Included, Adjustable Shade**

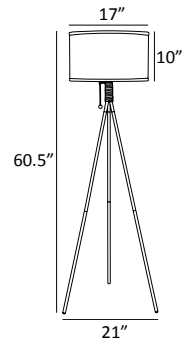
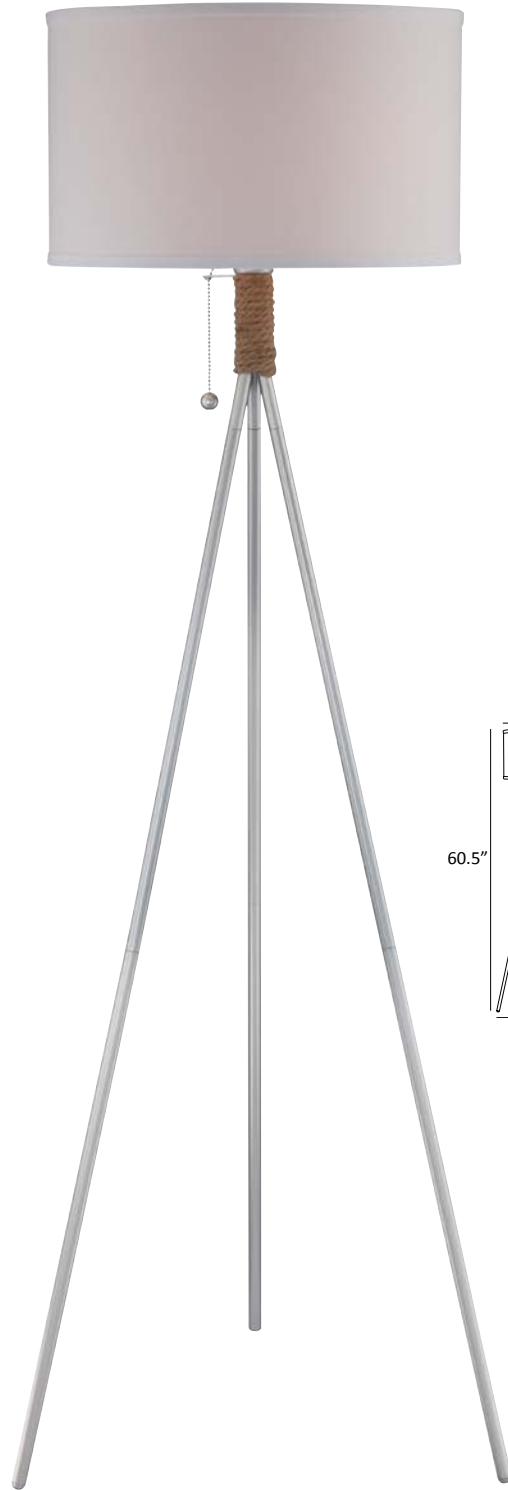
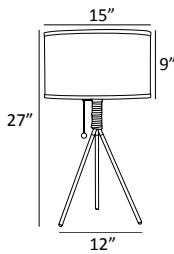

LS-22762 · Trixie Table Lamp

Body: Silver Metal / Natural Rope
 Shade: Off-White / Fabric
 Switch: On/Off Pull-Chain
 Lamp: E-27 Medium Base (Max. 100W)
 Features: **Tri-pod, Top Diffuser**

LS-82762 · Trixie Floor Lamp

Body: Silver Metal / Natural Rope
 Shade: Off-White / Fabric
 Switch: On/Off Pull-Chain
 Lamp: E-27 Medium Base (Max. 150W)
 Features: **Tri-pod, Top Diffuser**

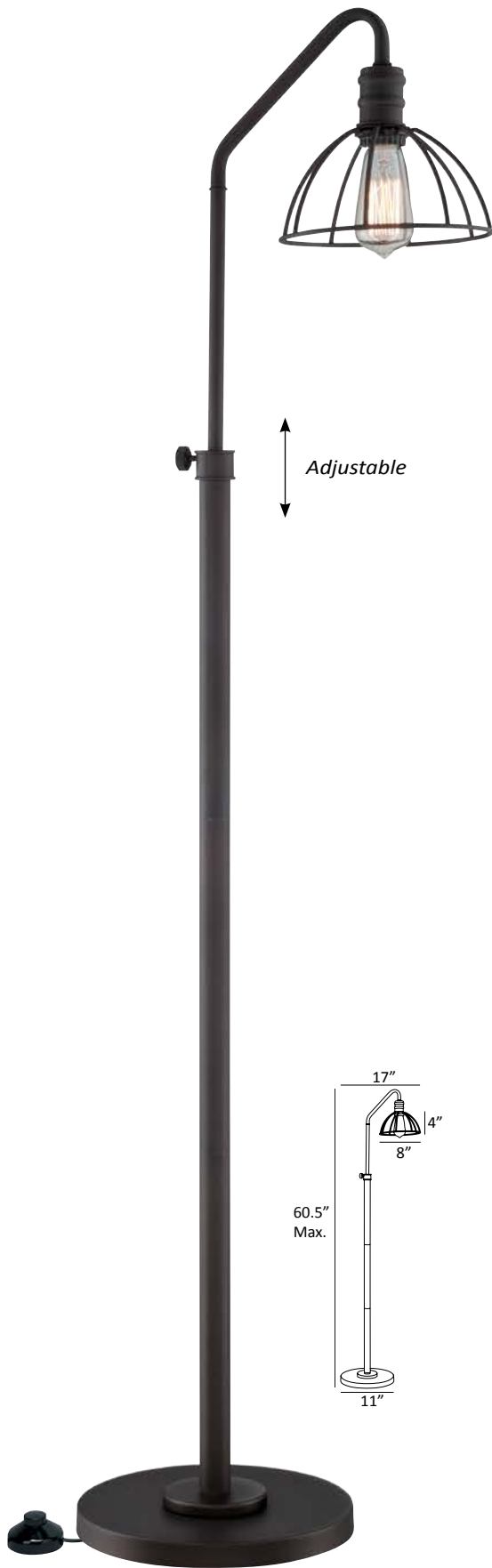

Adjustable

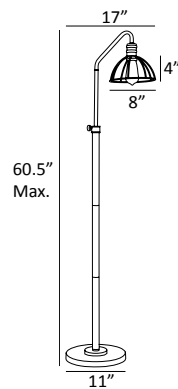

Adjustable

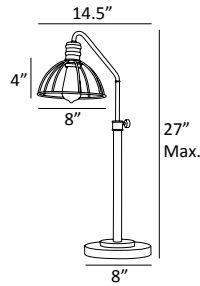

LS-82835 · Gaius Floor Lamp

Body: Dark Bronze / Metal
 Shade: Dark Bronze / Metal
 Switch: On/Off In-Line
 Lamp: E-27 Medium Base (Max. 60W)
 Features: **Vintage Edison Bulb Included, Adjustable Height**

LS-22835 · Gaius Table Lamp

Body: Dark Bronze / Metal
 Shade: Dark Bronze / Metal
 Switch: On/Off In-Line
 Lamp: E-27 Medium Base (Max. 40W)
 Features: **Vintage Edison Bulb Included, Adjustable Height**



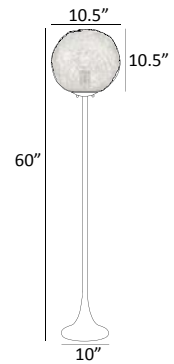
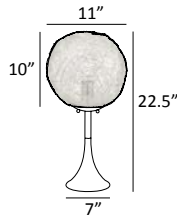
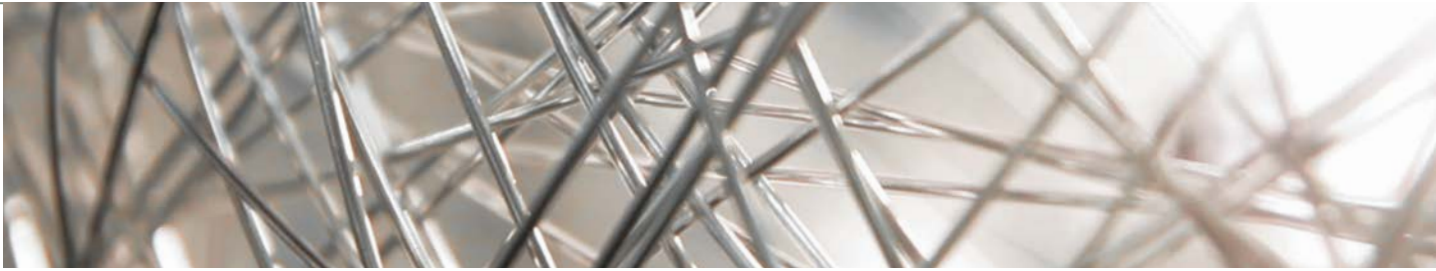

LS-22374 · Kolina Table Lamp
 Body: Chrome / Metal
 Shade: Hand-Knitted / Aluminum
 Switch: On/Off In-Line
 Lamp: E-27 Medium Base (Max. 60W)

LS-82374 · Kolina Floor Lamp
 Body: Chrome / Metal
 Shade: Hand-Knitted / Aluminum
 Switch: On/Off Foot
 Lamp: E-27 Medium Base (Max. 100W)

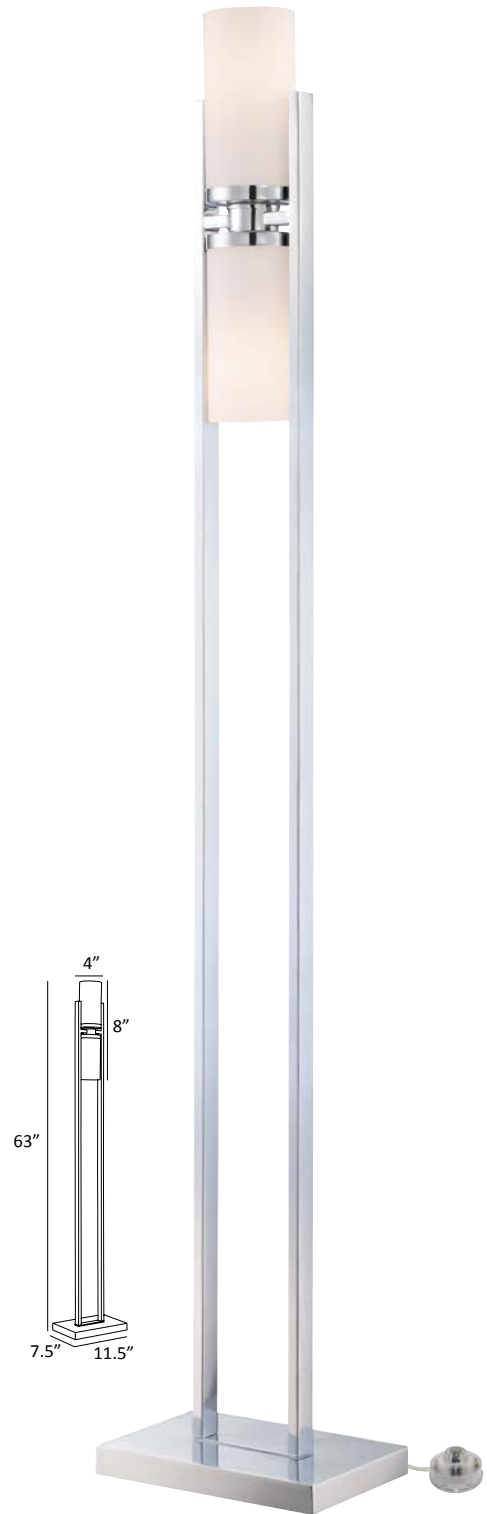
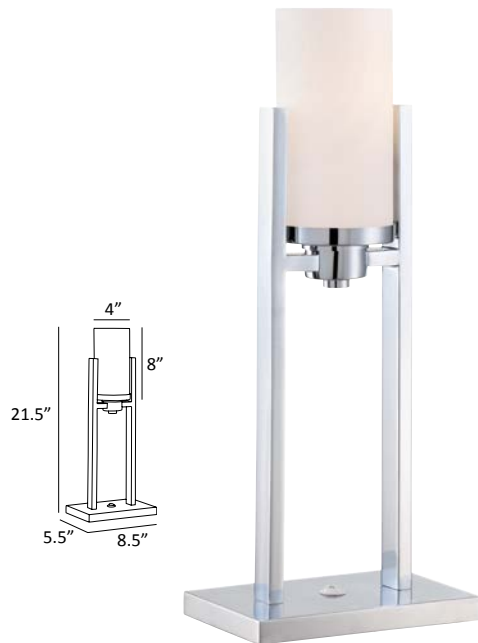

LS-18811 · Caesarea Chandelier

Body: Chrome / Metal
 Shade: Frosted / Glass
 Lamp: E-27 Medium Base (Max. 60W) x6

LS-22811 · Caesarea Table Lamp

Body: Chrome / Metal
 Shade: Frosted / Glass
 Switch: On/Off Rocker On Base
 Lamp: E-27 Medium Base (Max. 60W)

LS-82811 · Caesarea Floor Lamp

Body: Chrome / Metal
 Shade: Frosted / Glass
 Switch: On/Off Foot
 Lamp: E-27 Medium Base (Max. 60W)

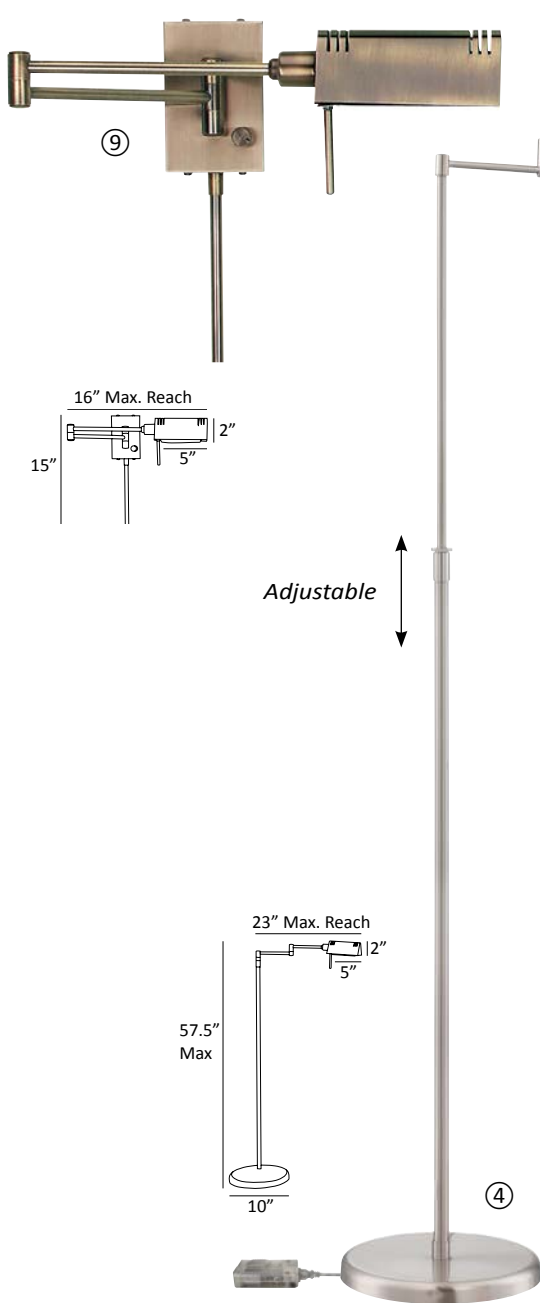
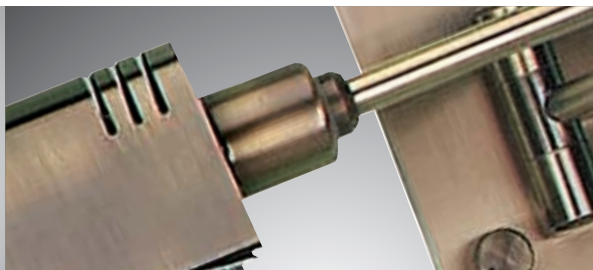

Antique Brass Finish ① ⑥



Black Finish ② ⑦



Dark Bronze Finish ③



Satin Steel Finish ⑤

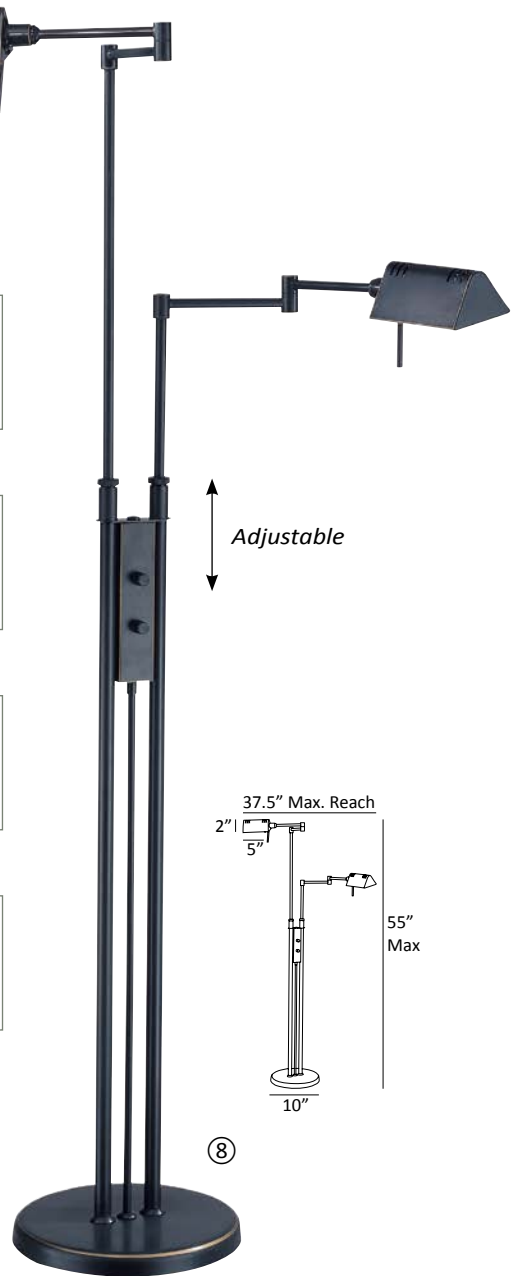

⑧

LS-960AB ①

LS-960BLK ②

LS-960D/BRZ ③

LS-960PS ④

LS-960SS ⑤

· Pharma Floor Lamp

Body: Antique Brass, Black, Dark Bronze, Polished Steel or Satin Steel / Metal
Shade: Matching Finish / Metal
Switch: Dimmer Foot
Lamp: J Type Halogen (Max. 100W)
Features: **Dimmable, Swing Arm, Adjustable Height & Shade**

LS-974AB ⑥

LS-974BLK ⑦

LS-974D/BRZ ⑧

· Pharma 2-Lite Floor Lamp

Body: Antique Brass, Black or Dark Bronze / Metal
Shade: Matching Finish / Metal
Switch: Dual Dimmer Rotary on Pole
Lamp: J Type Halogen (Max. 100W) x2
Features: **Dimmable, Swing Arm, Adjustable Height & Shades**

LS-1101AB ⑨ · Pharma Wall Lamp

Body: Antique Brass / Metal
Shade: Antique Brass / Metal
Switch: Dimmer Rotary on Canopy
Lamp: J Type Halogen (Max. 100W)
Features: **Dimmable, Swing Arm, Adjustable Height & Shades, Metal Cord Cover Included**



MULTI-LITE



LS-9485M/BLK ①
 · Multi-Lite 5-Lite Arc Floor Lamp
 Body: Black / Metal
 Shade: Matching Finish Metal
 Switch: 3-Way Rotary on Pole
 Lamp: E-12 Candelabra Base (Max. 60W) x5
 Features: **3-Way Switch, Black Marble Base**

LS-9485M/BRZ ②
 · Multi-Lite 5-Lite Arc Floor Lamp
 Body: Dark Bronze / Metal
 Shade: Matching Finish Metal
 Switch: 3-Way Rotary on Pole
 Lamp: E-12 Candelabra Base (Max. 60W) x5
 Features: **3-Way Switch, Black Marble Base**

LS-9485M/PS ③
 · Multi-Lite 5-Lite Arc Floor Lamp
 Body: Black, Dark Bronze or Polished Steel / Metal
 Shade: Matching Finish Metal
 Switch: 3-Way Rotary on Pole
 Lamp: E-12 Candelabra Base (Max. 60W) x5
 Features: **3-Way Switch, Black Marble Base**

RUSTIC & INDUSTRIAL

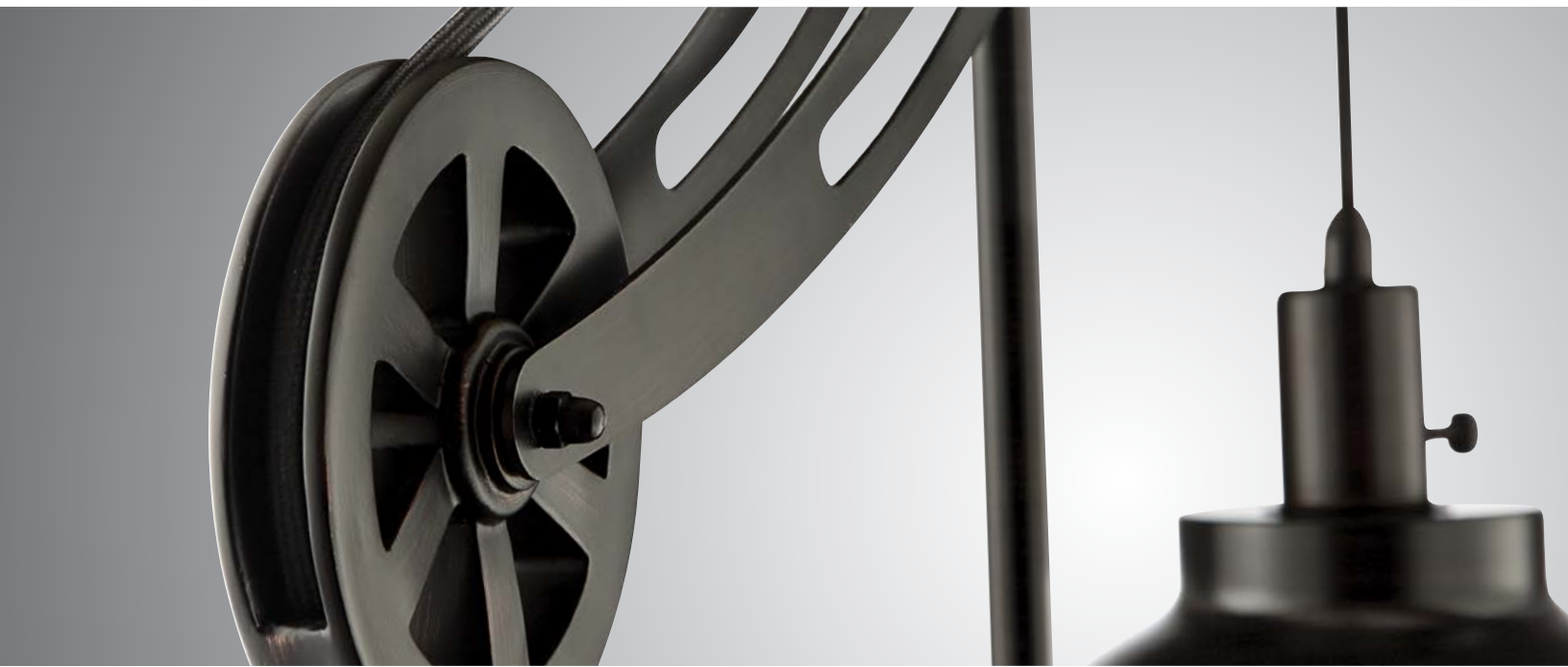



LS-83117 · Garrad Pulley Floor Lamp

Body: Antique Silver / Metal
 Shade: Antique Silver / Metal
 Switch: On/Off Socket
 Lamp: E-27 Medium Base (Max. 60W)
 Features: **Adjustable Pulley, 60W Vintage Edison Bulb Included**

LS-83118 · Garrett Pulley Floor Lamp

Body: Dark Bronze / Metal
 Shade: Dark Bronze / Metal
 Switch: On/Off Socket
 Lamp: E-27 Medium Base (Max. 60W)
 Features: **Adjustable Pulley**

WAYLAND
DENZEL
TINDRA

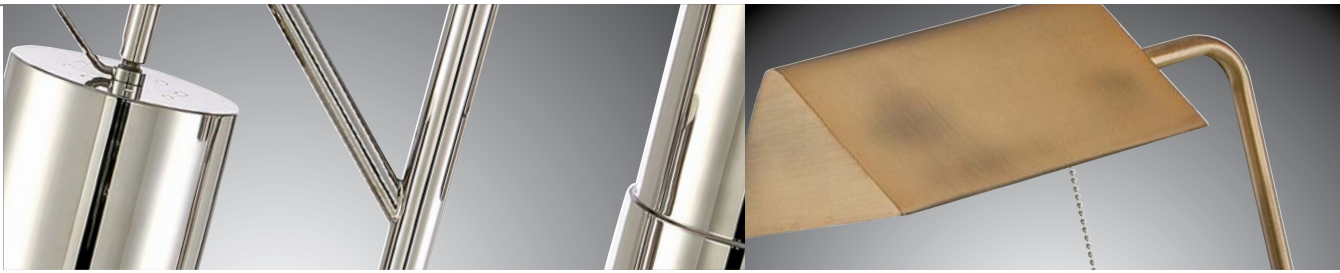

LS-82341BB ① · Wayland Floor Lamp

Body: Brushed Brass / Metal
Shade: Brushed Brass / Metal
Switch: On/Off Pull-Chain
Lamp: E-27 Medium Base (Max. 100W)
Features: **Adjustable Height**

LS-82100PS ② · Denzel Floor/Reading Lamp

Body: Polished Steel / Metal
Shade: Polished Steel / Metal
Switch: 3-Way Rotary on Pole
Lamp: E-12 Candelabra Base (Max. 40W) x3
Features: **3-Way Switch, Adjustable Shades**

LS-82818 ③ · Tindra Floor Lamp

Body: Chrome / Metal
Shade: Chrome / Metal
Switch: 3-Way Rotary on Pole
Bulb Base: E-27 Medium Base (Max. 60W) x3
Features: **3-Way Switch, Adjustable Shades**

RUSTIC & INDUSTRIAL



LS-82597D/BRZ ①

LS-82597PS ② · Palesa Floor Lamp

Body: Dark Bronze or Polished Steel / Metal
 Shade: Matching Finish / Metal
 Switch: On/Off Foot
 Lamp: E-27 Medium Base (Max. 100W)
 Features: **Adjustable Shade**

LS-83030 ③ · Braun 3-Lite Arc Floor Lamp

Body: Dark Bronze / Metal
 Shade: Brushed Copper / Metal
 Switch: 3-Way Rotary on Pole
 Lamp: E-12 Candelabra Base (Max. 40W) x3
 Features: **3-Way Switch, Black Marble Base**

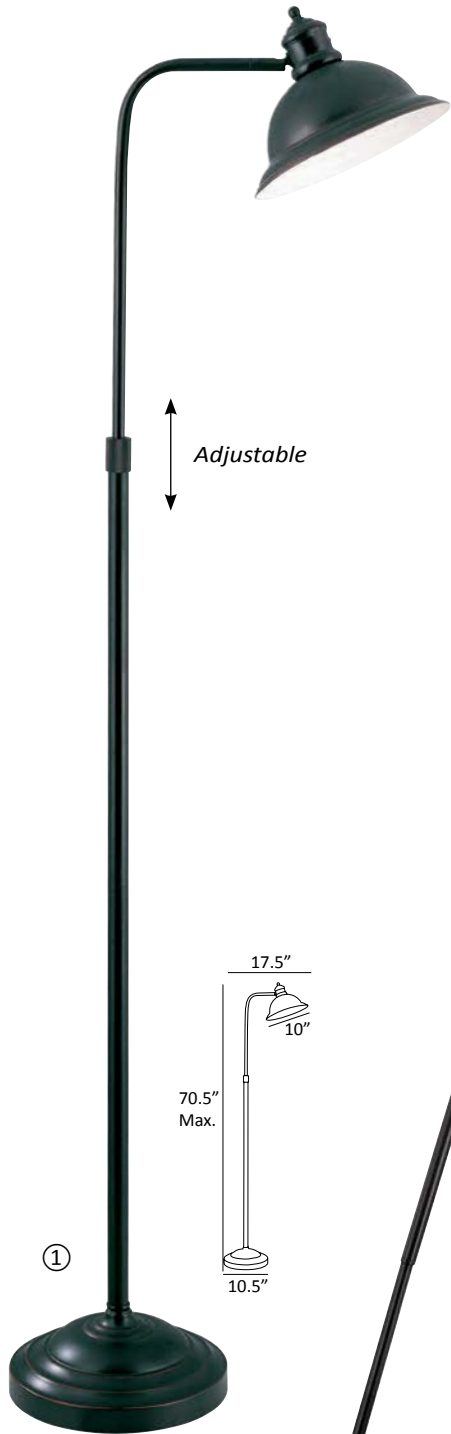

Adjustable

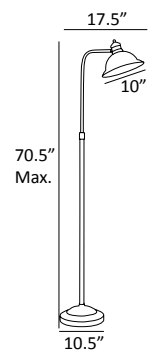

①



Adjustable

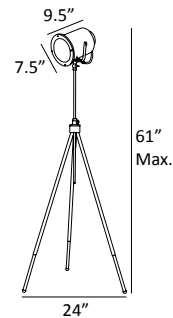

②

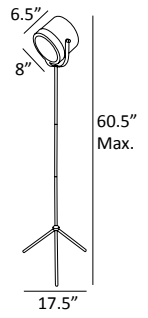
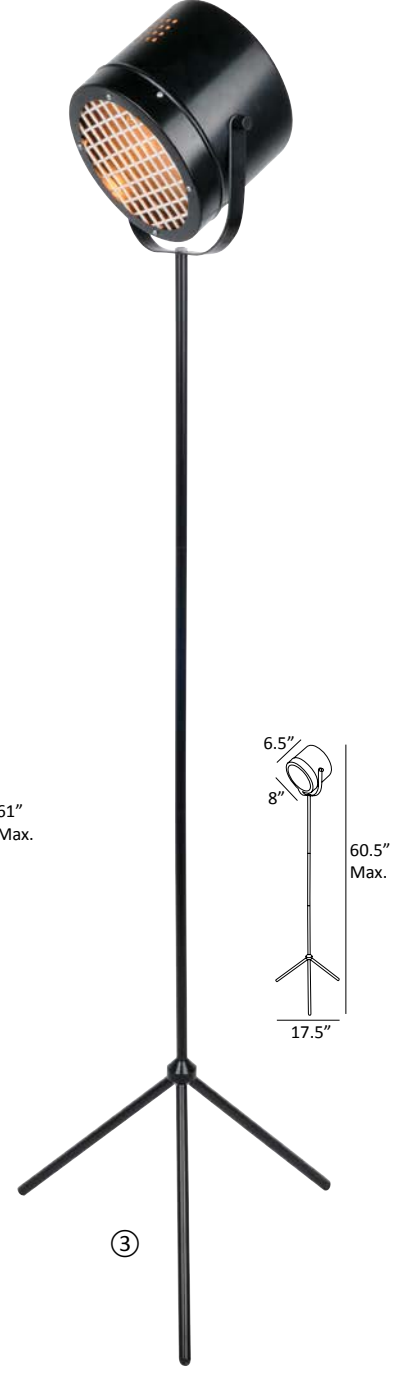

③

LS-8550AGED/CP ①
 · Minuteman Floor Lamp
 Body: Aged Copper / Metal
 Shade: Aged Copper / Metal
 Switch: On/Off Socket
 Lamp: E-27 Medium Base (Max. 100W)
 Features: **Adjustable Shade**

LS-81724D/BRZ ② · Directeur Floor Lamp
 Body: Dark Bronze / Metal
 Shade: Dark Bronze Metal / Frosted Diffuser
 Switch: On/Off Foot
 Lamp: E-27 Medium Base (Max. 100W)
 Features: **Adjustable Tripod & Shade**

LS-82962 ③ · Lucine Floor Lamp
 Body: Black / Metal
 Shade: Black Metal / White Grid
 Switch: Dimmer Rotary on Shade
 Bulb Base: E-27 Medium Base (Max. 43W)
 Features: **Halogen Bulb Included, Dimmer Switch, Adjustable Shade**



BALDWIN
GEORDI
POURIA
SAILOR
MACYCN



①

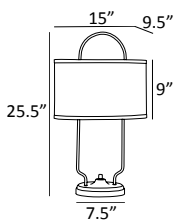

②

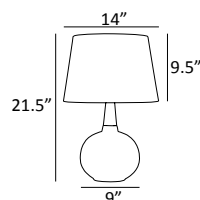

③

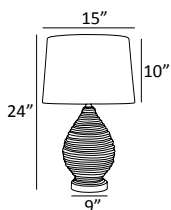

④



⑤

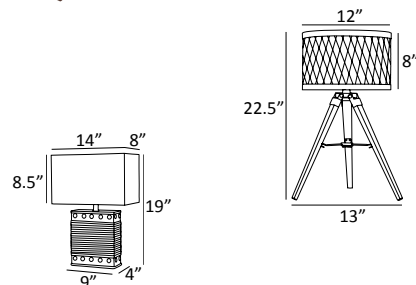

LS-22705 ① · Baldwin Table Lamp

Body: Dark Bronze / Metal
Shade: Linen / Fabric
Switch: On/Off Socket
Lamp: E-27 Medium Base (Max. 100W)

LS-22746 ② · Geordi Table Lamp

Body: 2-Tone Copper Ceramic / Copper Metal
Shade: Off-White / Fabric
Switch: On/Off Socket
Lamp: E-27 Medium Base (Max. 100W)

LS-22750 ③ · Pouria Table Lamp

Body: Thick Natural / Rope
Shade: Tan Linen / Fabric
Switch: On/Off Socket
Lamp: E-27 Medium Base (Max. 100W)

LS-22751 ④ · Sailor Table Lamp

Body: Rustic Finish Polyresin / Natural Rope
Shade: Tan Linen / Fabric
Switch: On/Off Socket
Lamp: E-27 Medium Base (Max. 100W)

LS-22797 ⑤ · Macyn Table Lamp

Body: Walnut Wood / Aged Rust Metal
Shade: Aged Rust Metal / Burlap Fabric
Switch: On/Off In-Line
Lamp: E-27 Medium Base (Max. 100W)

RUSTIC & INDUSTRIAL

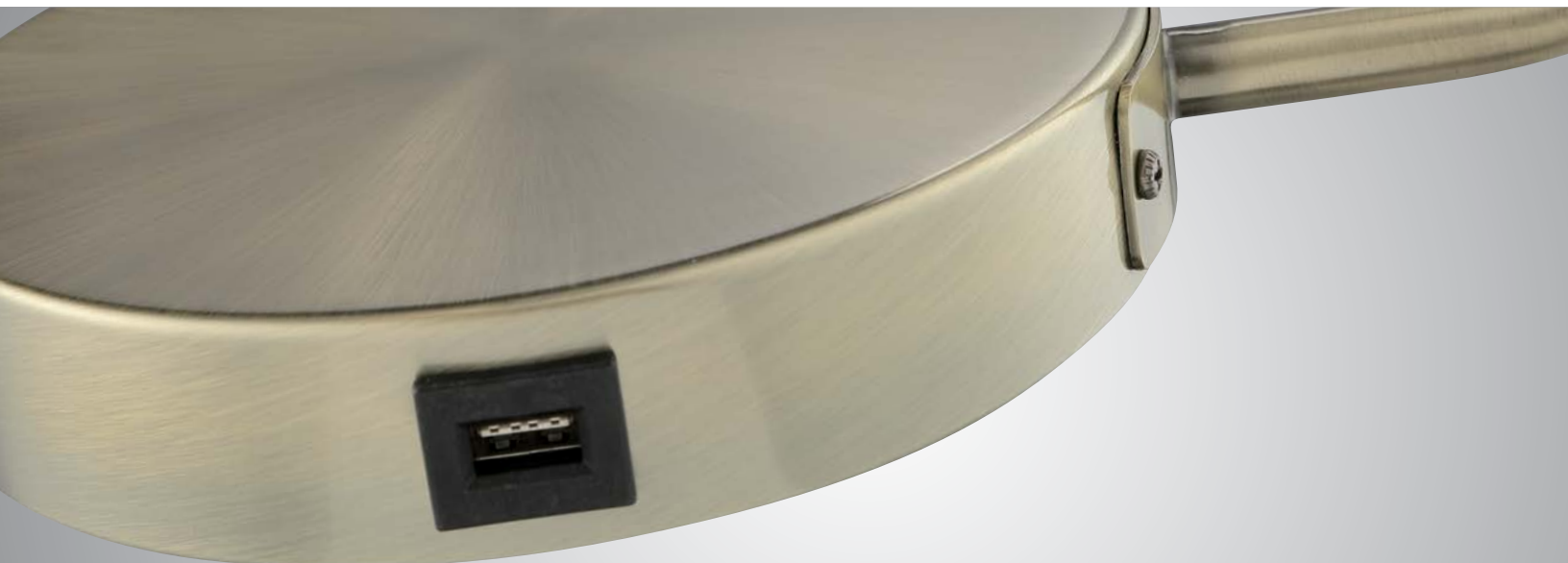

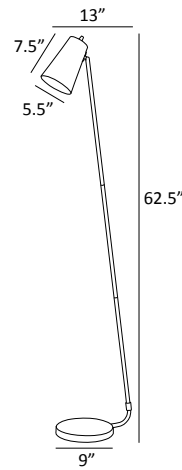
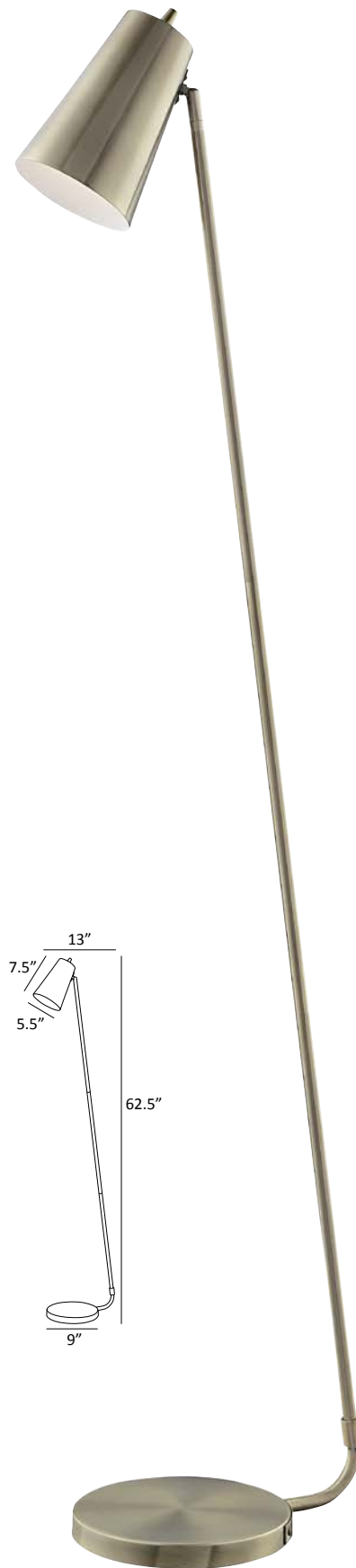
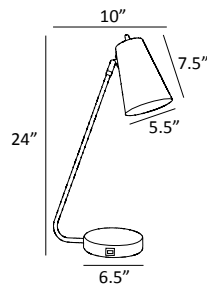

LS-23194AB · McCoy Table Lamp

Body: Antique Brass / Metal
 Shade: Antique Brass / Metal
 Switch: On/Off Rotary on Shade
 Lamp: E-27 Medium Base (Max. 60W)
 Features: **Adjustable Shade, USB Charging Port x1**

LS-83194AB · McCoy Floor Lamp

Body: Antique Brass / Metal
 Shade: Antique Brass / Metal
 Switch: On/Off Rotary on Shade
 Lamp: E-27 Medium Base (Max. 60W)
 Features: **Adjustable Shade**



①

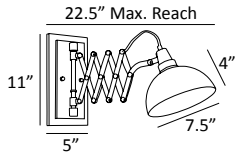

②

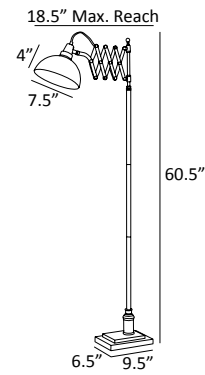
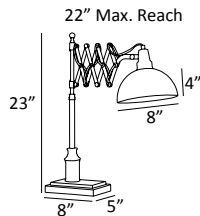

③



LS-16280 ① · Armstrong Wall Lamp

Body: Dark Bronze / Metal
 Shade: Dark Bronze / Metal
 Lamp: E-27 Medium Base (Max. 60W)
 Features: **Accordion Swing Arm**

LS-22280 ② · Armstrong Desk/Table Lamp

Body: Dark Bronze / Metal
 Shade: Dark Bronze / Metal
 Switch: On/Off In-Line
 Lamp: E-27 Medium Base (Max. 60W)
 Features: **Accordion Swing Arm**

LS-82280 ③ · Armstrong Floor Lamp

Body: Dark Bronze / Metal
 Shade: Dark Bronze / Metal
 Switch: On/Off Foot
 Lamp: E-27 Medium Base (Max. 60W)
 Features: **Accordion Swing Arm**

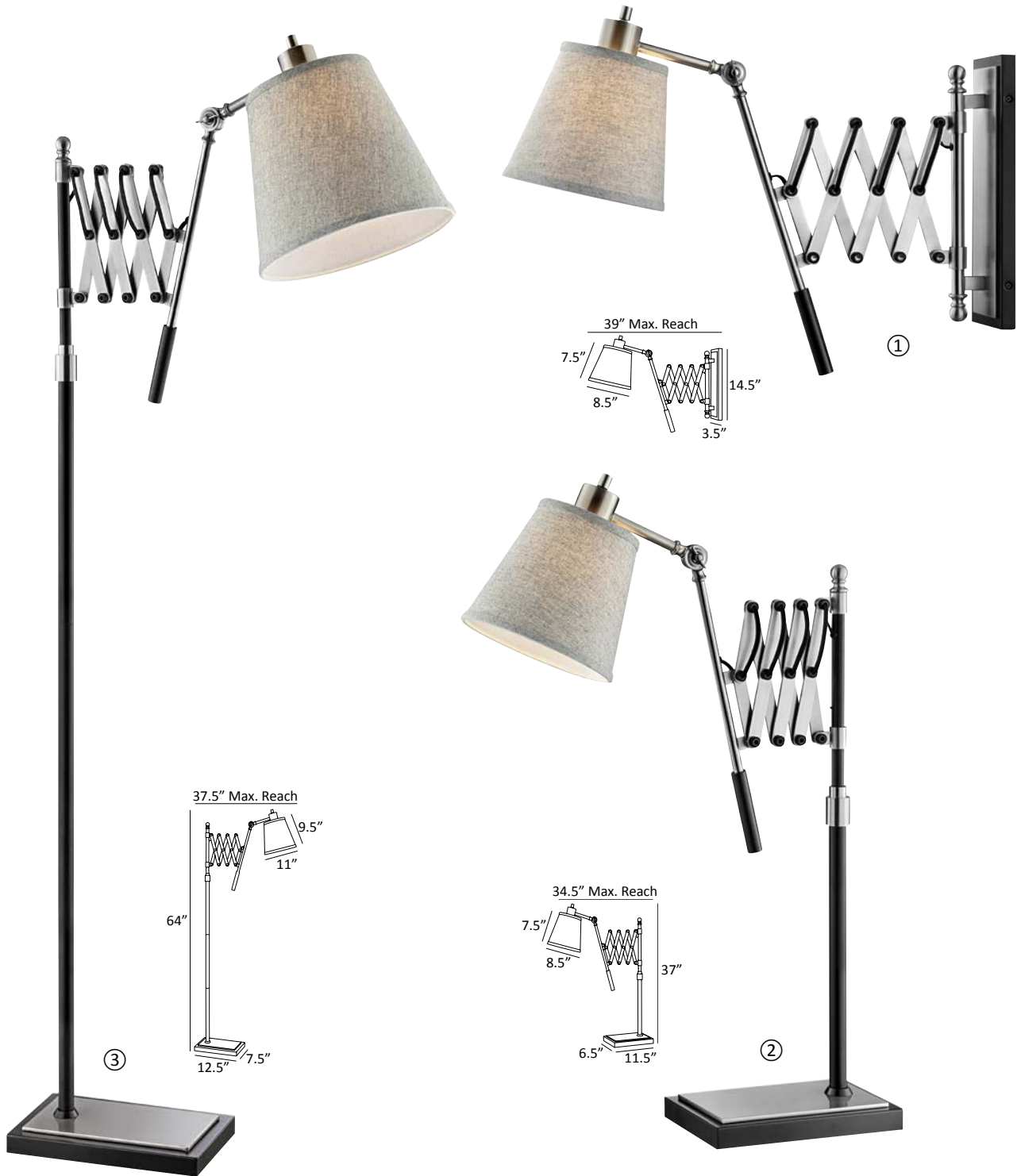

LS-16145 ① · Caprilla Wall Lamp

Body: Brushed Nickel & Black / Metal
 Shade: Light Grey Flannel / Fabric
 Switch: On/Off Rotary on Shade
 Lamp: E-27 Medium Base (Max. 40W)
 Features: **Accordion Swing Arm**

LS-23145 ② · Caprilla Desk/Table Lamp

Body: Brushed Nickel & Black / Metal
 Shade: Light Grey Flannel / Fabric
 Switch: On/Off Rotary on Shade
 Lamp: E-27 Medium Base (Max. 60W)
 Features: **Accordion Swing Arm**

LS-83145 ③ · Caprilla Floor Lamp

Body: Brushed Nickel & Black / Metal
 Shade: Light Grey Flannel / Fabric
 Switch: On/Off Rotary on Shade
 Lamp: E-27 Medium Base (Max. 60W)
 Features: **Accordion Swing Arm**

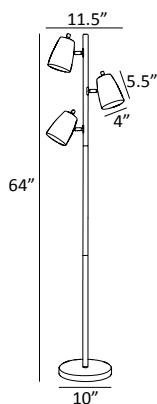

LS-83120BLK ① / LS-83120BN ② / LS-83120WHT ③ · Ronnie 3-Lite Floor Lamp

Body: Black, Brushed Nickel or White / Metal

Shade: Matching Finish / Metal

Switch: On/Off Rotary on Shade

Lamp: E-27 Medium Base (Max. 40W) x3

Features: **Adjustable Shades**



①



②



③

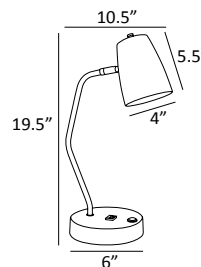

LS-23120BLK ① / LS-23120BN ② / LS-23120WHT ③ · Ronnie Desk Lamp

Body: Black, Brushed Nickel or White / Metal

Shade: Matching Finish / Metal

Switch: On/Off Rocker on Base

Lamp: E-27 Medium Base (Max. 60W)

Features: **Adjustable Shade, USB Charging Port x1**





LS-23046BLK ① / LS-23046GREY ② / LS-23046WHT ③ · Kalle Desk Lamp

Body: Black, Grey or White & Brushed Nickel Accent / Metal

Shade: Matching Finish / Metal

Switch: On/Off Rocker on Base

Lamp: E-27 Medium Base (Max. 60W)

Features: **Adjustable Arm & Shade, USB Charging Port x1**

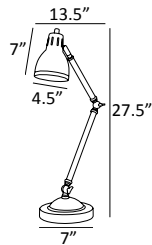
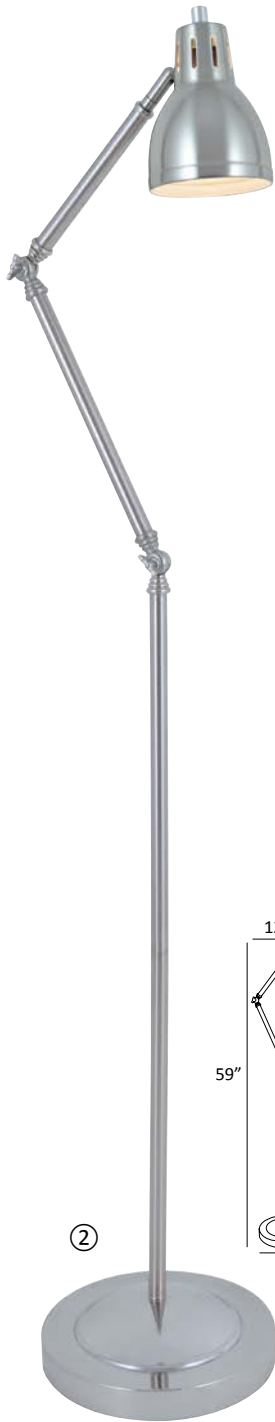
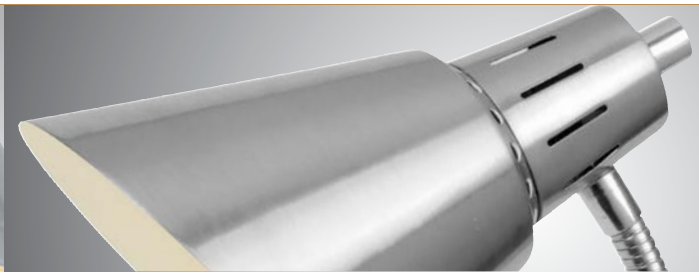

①

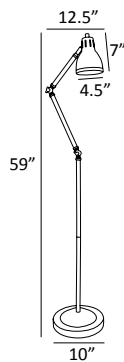

②

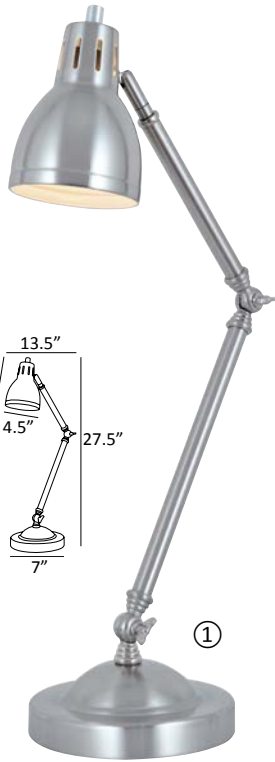

③

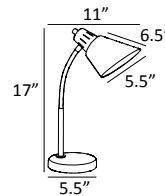
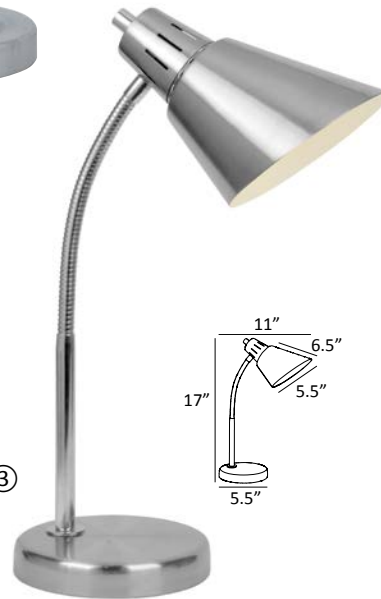

④

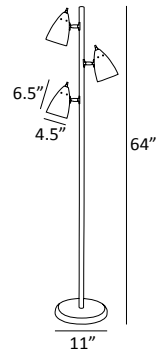

LS-22595PS ① · Haley Desk/Table Lamp

LS-82595PS ② · Haley Floor Lamp

Body: Polished Steel / Metal
Shade: Polished Steel / Metal
Switch: On/Off Rotary on Shade
Lamp: E-27 Medium Base (Max. 60W)
Features: **Adjustable Arm & Shade**

LS-22952 ③ · Lilia Desk Lamp

Body: Brushed Nickel / Metal
Shade: Brushed Nickel / Metal
Switch: On/Off Rotary on Shade
Lamp: E-27 Medium Base (Max. 60W)
Features: **Gooseneck**

LS-9406PS ④ · Bullets Floor Lamp

Body: Polished Steel / Metal
Shade: Polished Steel / Metal
Switch: On/Off Rotary on Shade
Lamp: E-27 Medium Base (Max. 60W) x3
Features: **Adjustable Shades**

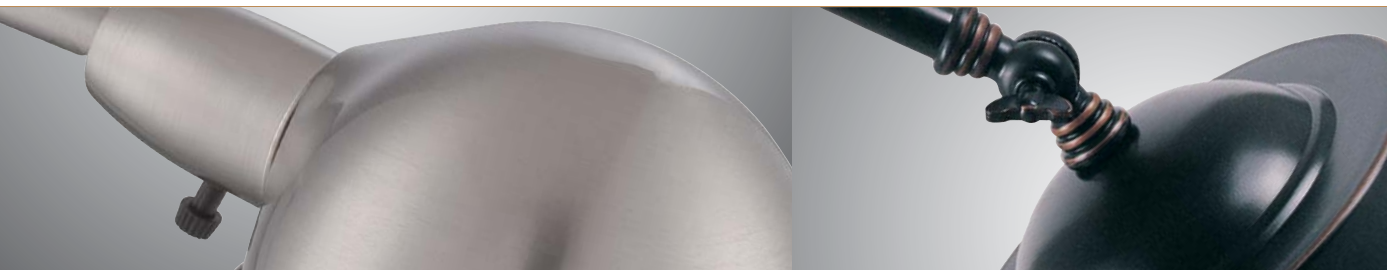

LS-21276 ① · Jensen Desk/Table Lamp

Body: Dark Bronze / Metal
 Shade: Dark Bronze / Metal
 Switch: On/Off Socket
 Lamp: E-27 Medium Base (Max. 60W)
 Features: **Adjustable Arm & Shade**

LS-81276 ② · Jensen Floor Lamp

Body: Dark Bronze / Metal
 Shade: Dark Bronze / Metal
 Switch: On/Off Socket
 Lamp: E-27 Medium Base (Max. 100W)
 Features: **Adjustable Arm & Shade**

LS-22682 ③ · Lucian Desk/Table Lamp

Body: Satin Nickel / Metal
 Shade: Satin Nickel / Metal
 Switch: On/Off Socket
 Lamp: E-27 Medium Base (Max. 60W)
 Features: **Adjustable Arm & Shade**

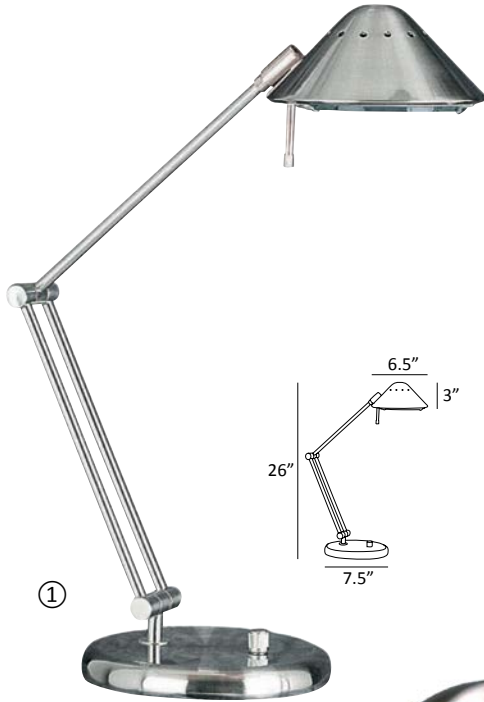

①



②



③



④

LS-3414PS ① · Space Traveler Desk Lamp

Body: Polished Steel / Metal
Shade: Polished Steel / Metal
Switch: Dimmer Rotary on Base
Lamp: J/78mm Halogen (Max. 100W)
Features: **Dimmer Switch, Adjustable Arm & Shade**

LS-9401PS ② · Space Traveler Floor Lamp

Body: Polished Steel / Metal
Shade: Polished Steel / Metal
Switch: Hi-Low Rotary on Pole
Lamp: J/78mm Halogen (Max. 100W)
Features: **Hi-Low Switch, Adjustable Shade**

LS-3421D/BRZ ③

LS-3421PS ④ · Flash Desk Lamp
Body: Dark Bronze or Polished Steel / Metal
Shade: Matching Finish / Metal
Switch: Dimmer Rotary on Base
Lamp: J/78mm Halogen (Max. 100W)
Features: **Dimmer Switch, Adjustable Arm & Shade**



LS-22375BLK ①

LS-22375SILV ② · Kade Desk Lamp

Body: Black or Silver / Metal & Plastic
 Shade: Matching Finish / Metal
 Switch: On/Off Rocker on Base
 Lamp: E-27 Medium Base (Max. 60W)
 Features: **Gooseneck, AC Outlet x2**

LS-22780BLK ③

LS-22780SILV ④ · Pagan Desk Lamp

Body: Black or Silver / Metal
 Shade: Matching Finish / Metal
 Switch: On/Off Rotary on Shade
 Lamp: E-27 Medium Base (Max. 60W)
 Features: **Gooseneck, AC Outlet x1, USB Charging Port x1**

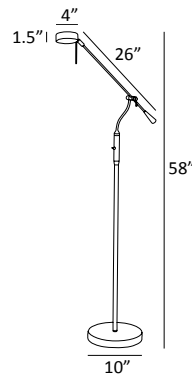
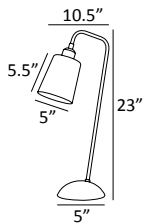
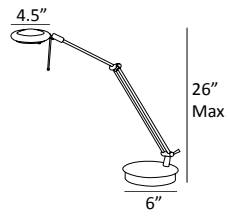
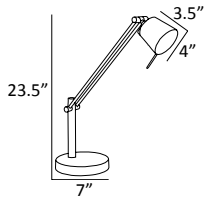
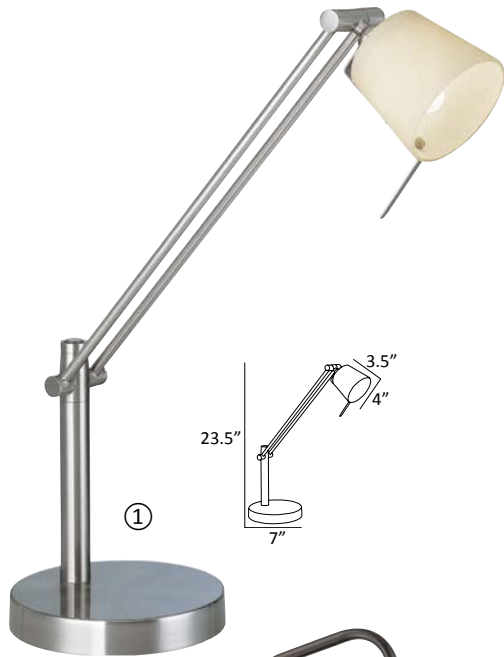
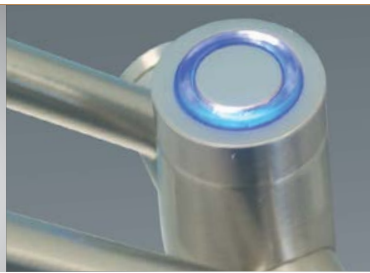

LS-2744PS/FRO ① · Fiona Desk Lamp

Body: Polished Steel / Metal
 Shade: Frosted / Glass
 Switch: 3-Way LED Touch on Pole
 Lamp: JCD/G9 Halogen Bulb (Max. 40W)
 Features: **Adjustable Arm & Shade, 3-Way Touch Switch**

LS-3896PS ② · Futura Desk Lamp

Body: Polished Steel / Metal
 Shade: Polished Steel Metal / Glass Diffuser
 Switch: Dimmer Rotary on Base
 Lamp: JC/G6.35 Halogen Bulb (Max. 35W)
 Features: **Adjustable Arm & Shade, Dimmer Switch**

LS-22894 ③ · Lovette Table Lamp

Body: Gun Metal / Metal
 Shade: Smoked Chrome / Glass
 Switch: On/Off In-Line
 Lamp: E-27 Medium Base (Max. 60W)
 Features: **Vintage Edison Bulb Included**

LS-81165BLK/PS ④ · Alogene Floor Lamp

Body: Black & Polished Steel / Metal
 Shade: Black / Metal
 Switch: On/Off Toggle on Pole
 Lamp: JCD/G9 Halogen Bulb (Max. 40W)
 Features: **Adjustable Arm & Shade**

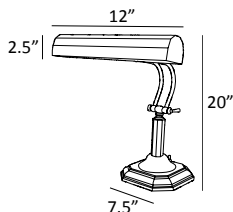
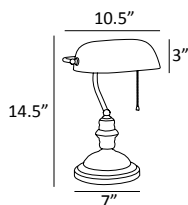

LS-224AB ① / LS-224D/BRZ ② / LS-224PB ③

· Banker Desk Lamp

Body: Antique Brass, Dark Bronze or Polished Brass / Metal
 Shade: Green or White / Glass
 Switch: On/Off Pull-Chain
 Lamp: E-27 Medium Base (Max. 60W)
 Features: **Adjustable Shade**

LS-398AB ④ / LS-398D/BRZ ⑤

· Piano Mate Desk Lamp

Body: Antique Brass or Dark Bronze / Metal
 Shade: Matching Finish / Metal
 Switch: On/Off Rotary on Base
 Lamp: E-27 Medium Base (Max. 40W) x2
 Features: **Adjustable Arm & Shade**



LS-22450 ① · Hassan Desk/Table Lamp

Body: Antique Brass / Metal
Shade: Black w. Gold Liner / Metal
Switch: On/Off In-Line
Lamp: E-27 Medium Base (Max. 100W)
Features: **Adjustable Arm & Shade**

LS-22538 ② · Maurizio Desk/Table Lamp

Body: Walnut Wood / Dark Bronze Metal
Shade: Dark Bronze / Metal
Switch: On/Off Rocker on Base
Lamp: E-27 Medium Base (Max. 60W)
Features: **Adjustable Shade, AC Outlet x1**

LS-22580 ③ · Gianna Desk/Table Lamp

Body: Antique Copper / Metal
Shade: Antique Copper / Metal
Switch: On/Off In-Line
Lamp: E-27 Medium Base (Max. 60W)
Features: **Adjustable Shade**



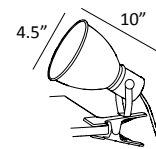
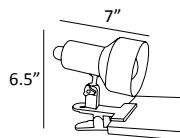
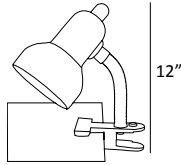
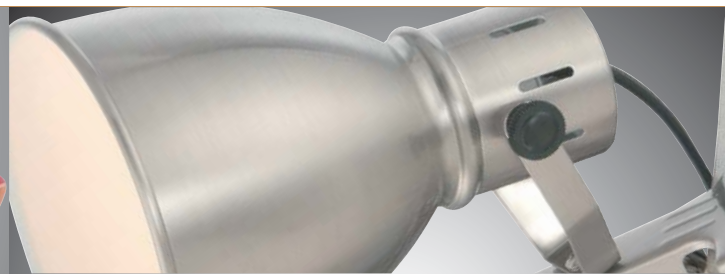

LS-111BLK ① / LS-111BLU ② / LS-111IVY ③
/ LS-111RED ④ / LS-111WHT ⑤
· "Clip-On" Clip-On Lamp

Body: Black / PS
Shade: Black, Blue, Ivory, Red or White / Metal
Switch: On/Off Rotary on Shade
Lamp: E-27 Medium Base (Max. 60W)
Features: **Gooseneck**

LS-114BLK ⑥ / LS-114BLU ⑦
/ LS-114RED ⑧ / LS-114WHT ⑨
· "Clip-On II" Clip-On Lamp

Body: Chrome Metal / Black PS
Shade: Black, Blue, Red or White / Metal
Switch: On/Off Rotary on Shade
Lamp: E-27 Medium Base (Max. 60W)
Features: **Adjustable Shade**

LS-23005 ⑩ · Kieffer Clip-On Lamp

Body: Brushed Nickel / Metal
Shade: Brushed Nickel / Metal
Switch: On/Off In-Line
Lamp: E-27 Medium Base (Max. 60W)
Features: **Adjustable Shade**



①



②



③

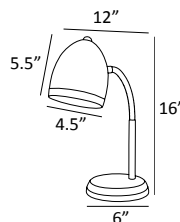

④



⑤



⑥

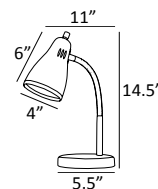

**LS-22311BLK ① / LS-22311BLU ② / LS-22311PS ③
/ LS-22311RED ④ / LS-22311WHT ⑤ · Zachary Desk Lamp**

Body: Black, Blue, Polished Steel, Red or White
& Chrome Finish Gooseneck / Metal
Shade: Matching Finish & Chrome Finish Trim / Metal
Switch: On/Off In-Line
Lamp: GU24 Base (Max. 60W)
Features: **13W CFL Bulb Included, Gooseneck**

LS-22535WHT ⑥ · Kris Desk Lamp

Body: White Metal / Chrome Finish Gooseneck
Shade: White w. Chrome Trim / Metal
Switch: On/Off Rotary on Shade
Lamp: E-27 Medium Base (Max. 40W)
Features: **Gooseneck**

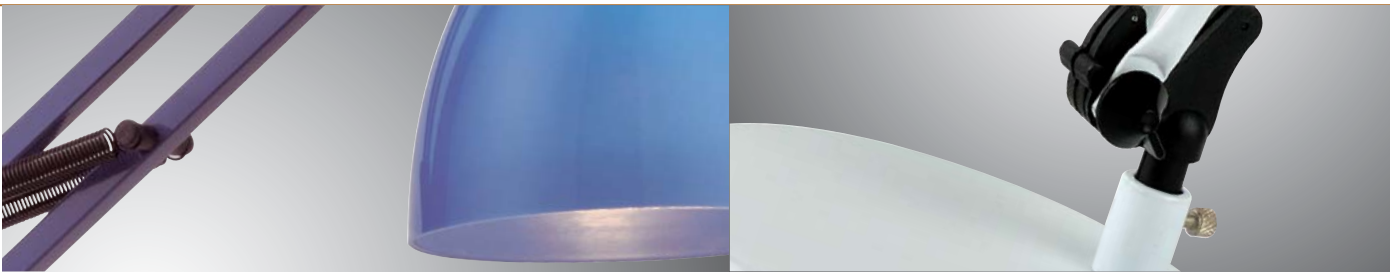

LS-22110BLU ① / LS-22110H/PINK ② / LS-22110PURP ③ / LS-22110WHT ④

· Karsten Desk Lamp
 Body: Blue, Hot Pink, Purple or White / Metal
 Shade: Matching Color / Poly
 Switch: On/Off Rotary on Shade
 Lamp: E-27 Medium Base (Max. 60W)
 Features: **Adjustable Arm & Shade**

LS-22312WHT ⑤

· Karolina Desk Lamp
 Body: White / Metal
 Shade: Matching Finish / Metal
 Switch: On/Off Rotary on Shade
 Lamp: E-27 Medium Base (Max. 60W)
 Features: **Adjustable Arm & Shade**



LS-105BLK ① / LS-105BLU ② / LS-105C ③ / LS-105PS ④ / LS-105RED ⑤ / LS-105WHT ⑥

· “Swing-Arm” Clamp-On Lamp

Body: Black, Blue, Chrome, Polished Steel, Red or White / Metal

Shade: Matching Finish / Metal

Switch: On/Off Rotary on Shade

Lamp: E-27 Medium Base (Max. 100W)

Features: **Adjustable Arm & Shade**



①

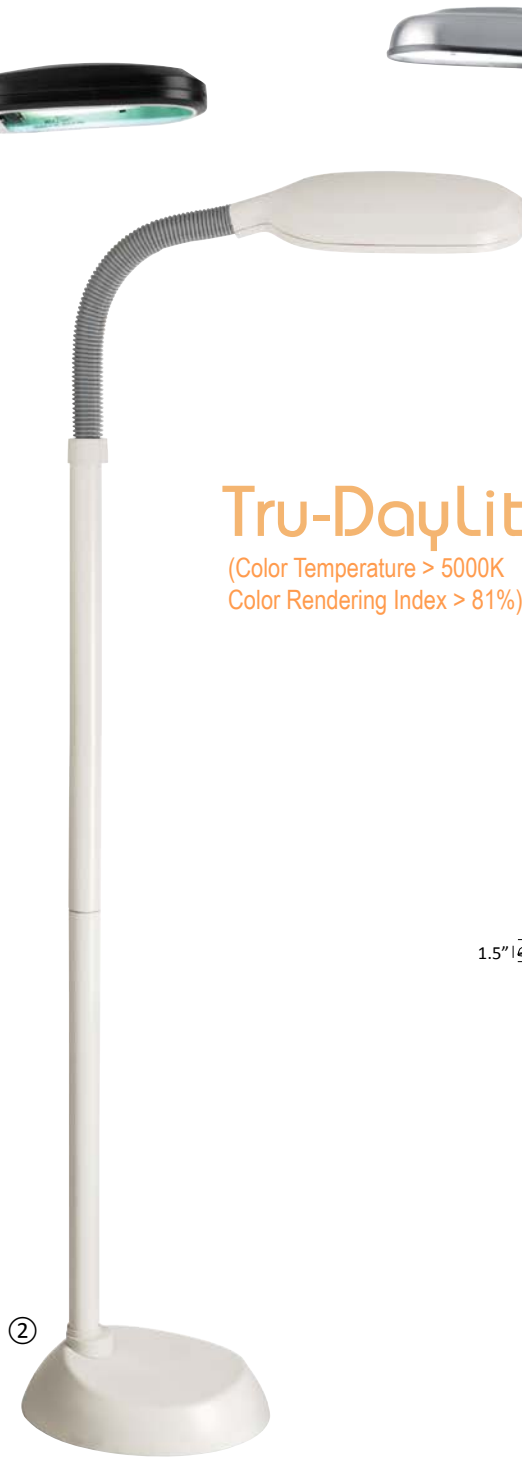
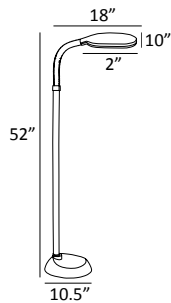

②

Tru-Daylite™

(Color Temperature > 5000K
Color Rendering Index > 81%)

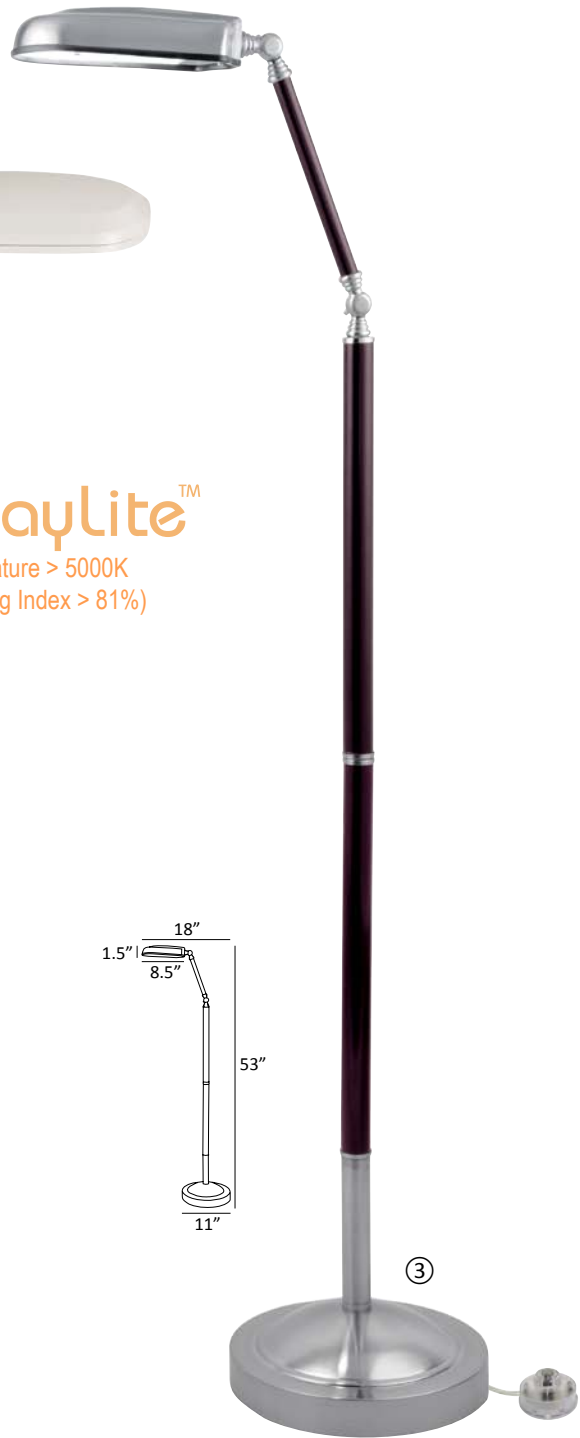

③

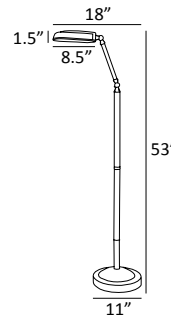

LSP-801BLK ①

LSP-801WHT ② · Aptos Floor Lamp

Body: Black or White / ABS Plastic
Shade: Matching Color / ABS Plastic
Switch: On/Off Rocker on Shade
Lamp: Quad-Pin CFL/2PL Bulb (Max. 27W)
Features: **6400K Tru-Daylite, Gooseneck**

LS-81922 ③ · Nuncio Floor Lamp

Body: Cherry Wood / Polished Steel Metal
Shade: Polished Steel / Metal
Switch: On/Off Foot
Lamp: Quad-Pin CFL/2PL Bulb (Max. 27W)
Features: **6400K Tru-Daylite, Adjustable Arm & Shade**



COMBINATION
MAGNIFY-LITE



Tru-Daylite™
(Color Temperature > 5000K
Color Rendering Index > 81%)

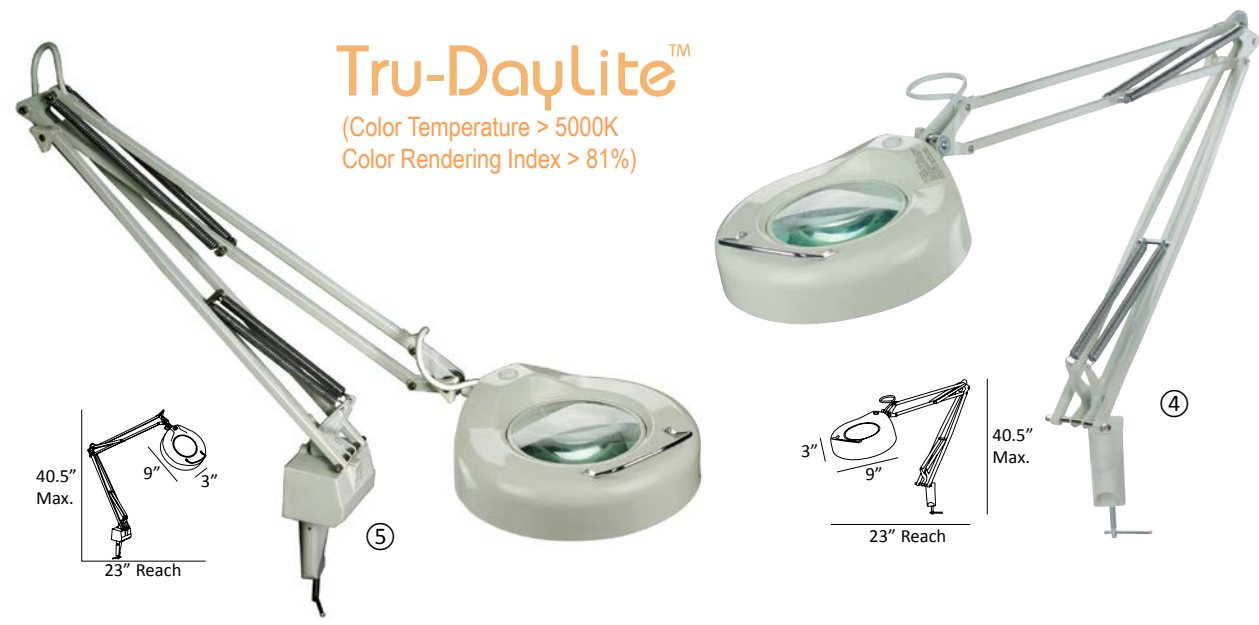

LSC-163BLK ① / LSC-163PS ② / LSC-163WHT ③

· Combination Clamp-On Task Lamp
Body: Black, Polished Steel or White / Metal
Shade: Matching Finish / Metal
Switch: Dual On/Off Rocker on Shade
Center Lamp: E-27 Medium Base (Max. 60W)
Work Lamp: Circuline Fluorescent T5 Bulb (Max. 25W)
Features: 6400K Tru-Daylite, Adjustable Arm & Shade, AC Outlet x1

LSM-180WHT ④ / LSM-181WHT ⑤

· Magnify-Lite Magnifier Lamp
Body: White / Metal
Shade: Matching Finish / Metal
Switch: On/Off Rocker on Shade
Lamp: Circuline Fluorescent T9 Bulb (Max. 22W)
Features: 3-Diopter Magnifier④, 5-Diopter Magnifier⑤, AC Outlet x1⑤, 6400K Tru-Daylite, Adjustable Arm & Shade

DESK & TASK



LS-82116MULTI ① · Uni II 5-Lite Floor Lamp
 Body: Chrome / Metal
 Shade: Multi-Color / Acrylic
 Switch: 3-Way Rotary on Pole
 Lamp: E-27 Medium Base (Max. 40W)
 Features: **Multi-Color Shades, 3-Way Switch, Goosenecks**

LS-82117 ②
LS-82117G/SMOKE ③ · Elitia 5-Lite Floor Lamp
 Body: Gun Metal
 Shade: Clear or Smoke / Acrylic
 Switch: 3-Way Rotary on Pole
 Lamp: E-27 Medium Base (Max. 40W)
 Features: **3-Way Switch, Goosenecks**



LS-211BLK ① / LS-211BLU ② / LS-211RED ③ / LS-211WHT ④

· Goosy Desk Lamp

Body: Black, Blue, Red or White Metal / Black Gooseneck

Shade: Matching Finish / Metal

Switch: On/Off Rotary on Shade

Lamp: E-27 Medium Base (Max. 60W)

Features: **Goosenecks**

LS-81615A/SMOKE ⑤ / LS-81615A/WHT ⑥

· Selika II Floor Lamp

Body: Chrome / Metal

Shade: Clear Acrylic / Smoke or Frosted Diffuser

Switch: On/Off Rotary on Shade

Lamp: E-27 Medium Base (Max. 60W) x3

Features: **Adjustable Shades**

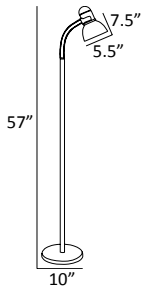
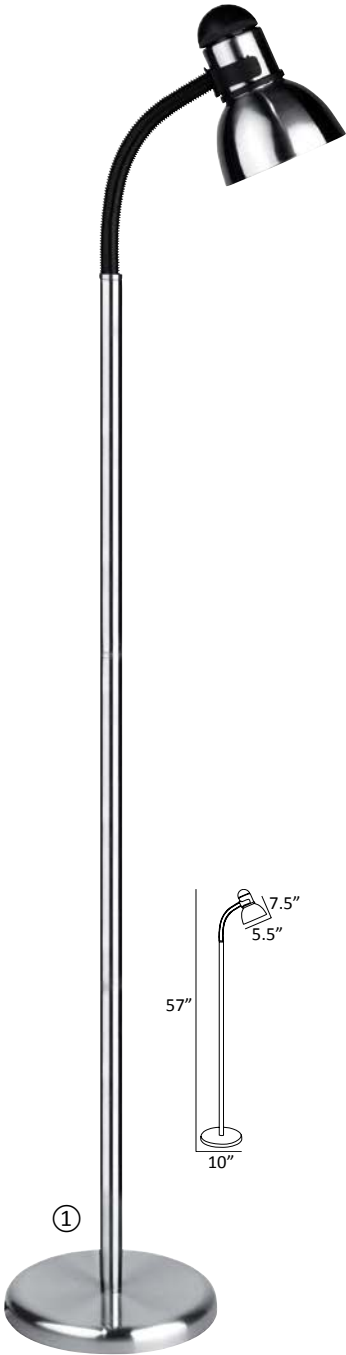
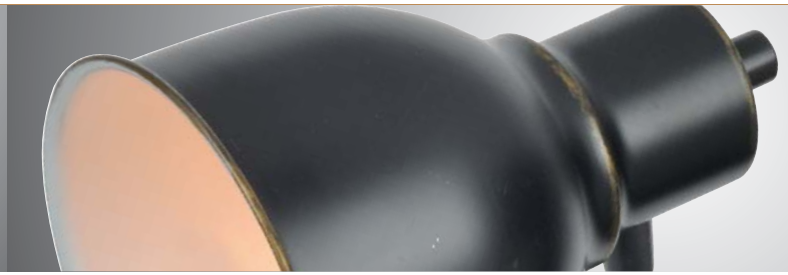

①

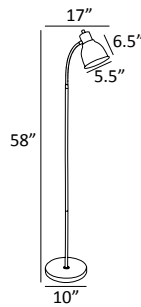

②

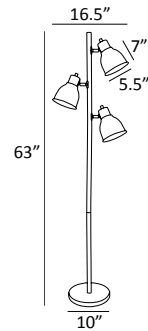

③

LS-8530PS/BLK ① · Henrik Floor Lamp

Body: Polished Steel Metal / Black Gooseneck
 Shade: Polished Steel / Metal
 Switch: On/Off Rotary on Shade
 Lamp: E-27 Medium Base (Max. 60W)
 Features: **Goosenecks**

LS-82953 ② · Galvin Floor Lamp

Body: Dark Bronze / Metal
 Shade: Dark Bronze / Metal
 Switch: On/Off Rotary on Shade
 Lamp: E-27 Medium Base (Max. 60W)
 Features: **Goosenecks**

LS-82954 ③ · Galvin 3-Lite Floor Lamp

Body: Dark Bronze / Metal
 Shade: Dark Bronze / Metal
 Switch: On/Off Rotary on Shade
 Lamp: E-27 Medium Base (Max. 60W) x3
 Features: **Adjustable Shades**

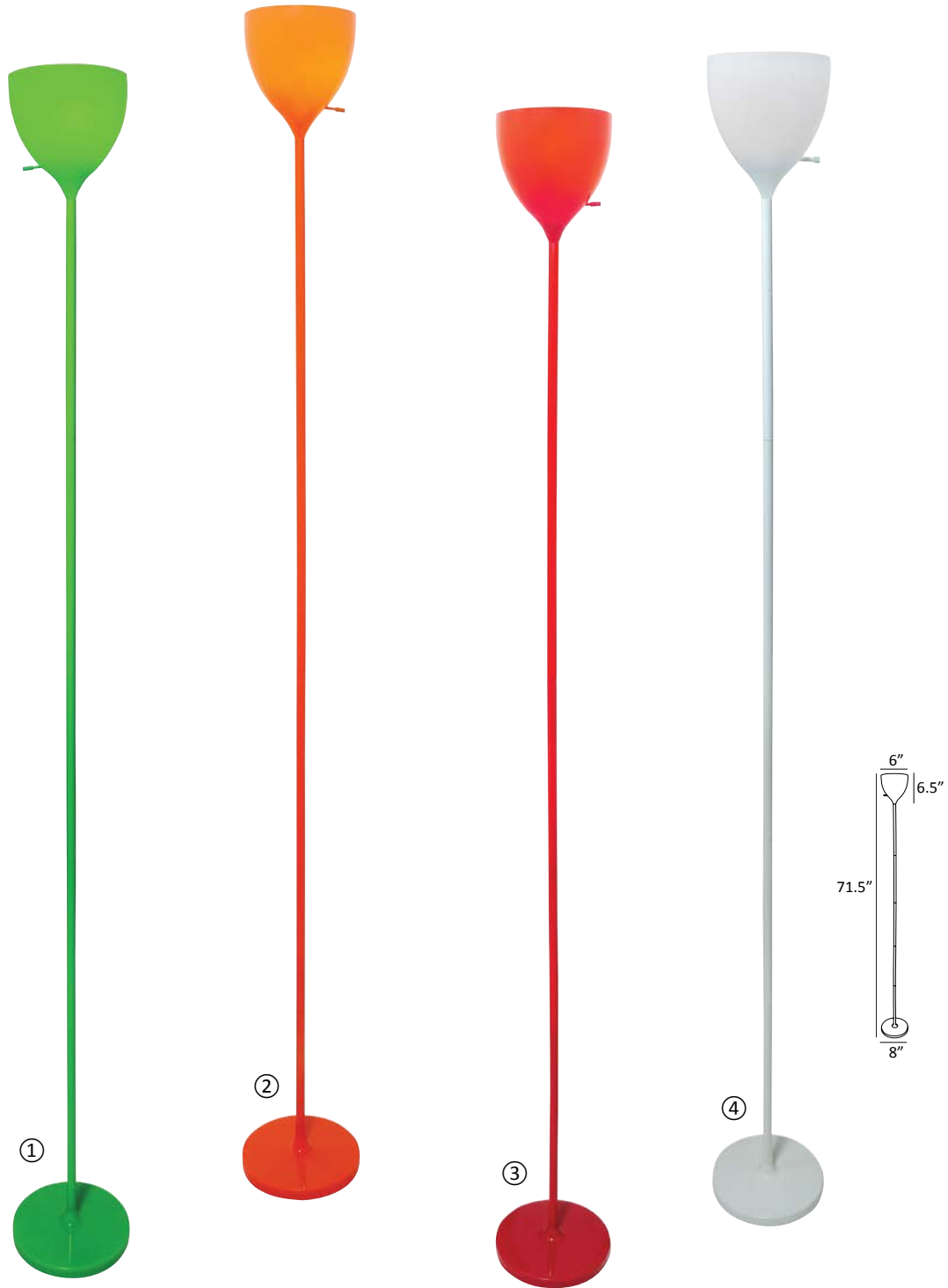
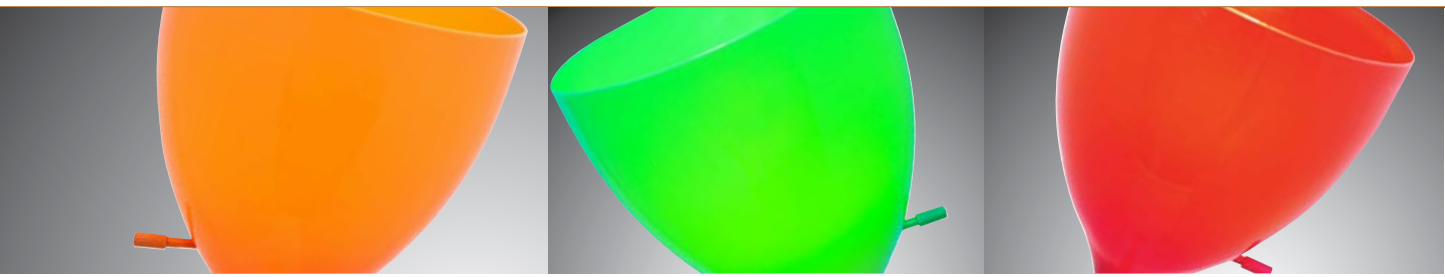

LS-82838GRN ① / LS-82838ORN ② / LS-82838RED ③ / LS-82838WHT ④

· Terran Torchiere Lamp

Body: Green, Orange, Red or White / Metal

Shade: Matching Color / Plastic

Switch: Dimmer on Socket

Lamp: E-27 Medium Base (Max. 72W)

Features: **Halogen Bulb Included, Dimmable**

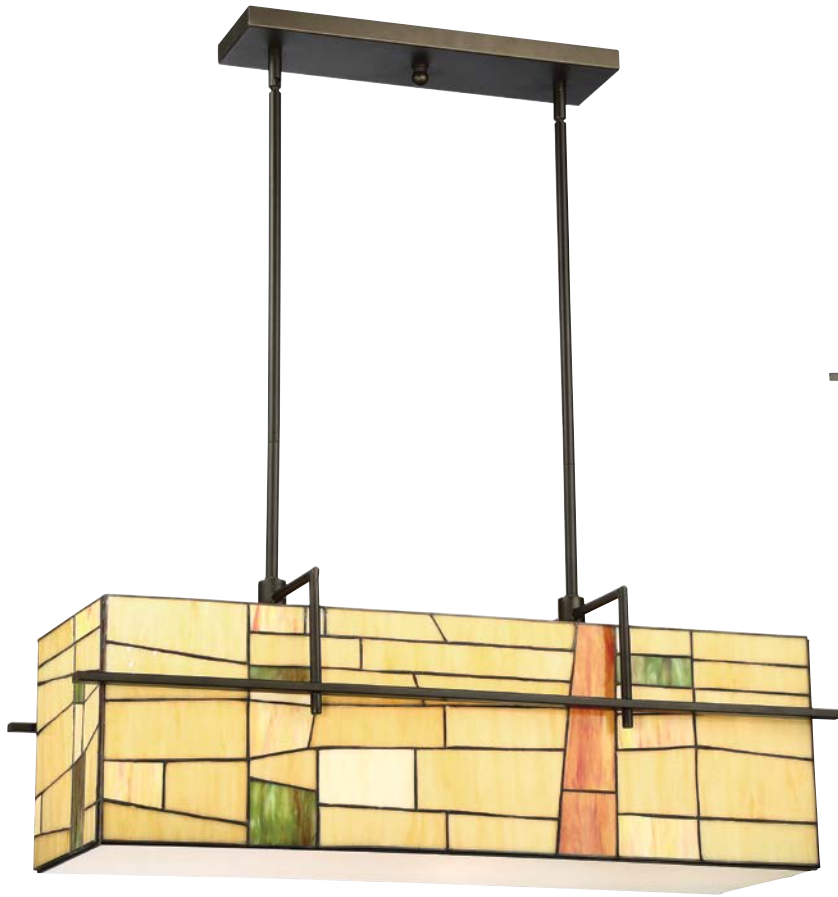

**C71396 · Mansur Pendant**

Body: Dark Bronze / Metal
 Shade: Tiffany / Glass
 Lamp: E-27 Medium Base (Max. 60W) x4
 Dimension: 63.5"Max. H x 36"W
 Features: **Tiffany Shade, Diffuser**

**C41396 · Mansur Table Lamp**

Body: Dark Bronze / Metal
 Shade: Tiffany / Glass
 Switch: On/Off Rotary on Base
 Lamp: E-27 Medium Base (Max. 60W) x2
 Dimension: 21"H x 16.5"W
 Features: **Tiffany Shade, Top Diffuser**

**C61396 · Mansur Floor Lamp**

Body: Dark Bronze / Metal
 Shade: Tiffany / Glass
 Switch: On/Off Foot
 Lamp: E-27 Medium Base (Max. 60W) x2
 Dimension: 65.5"H x 20.5"W
 Features: **Tiffany Shade, Top Diffuser**

**C41402** · Hyden Table Lamp

Body: Dark Bronze / Metal
 Shade: Two-Tone / Mercury Glass
 Switch: Dual Pull-Chain
 Lamp: E-27 Medium Base (Max. 60W) x2
 Dimension: 26.5"H x 16"W
 Features: **Two-Tone Mercury Glass**

C71402 · Hyden Pendant

Body: Dark Bronze / Metal
 Shade: Two-Tone / Mercury Glass
 Lamp: E-27 Medium Base (Max. 60W) x4
 Dimension: 60.5"Max. H x 32"W
 Features: **Two-Tone Mercury Glass, Diffuser**



C41397 · Collins Table Lamp

Body: Aged Gunmetal / Metal
 Shade: Tiffany / Glass
 Switch: On/Off Rotary on Base
 Lamp: E-27 Medium Base (Max. 60W) x2
 Dimension: 21"H x 16"W
 Features: **Tiffany Shade, Top Diffuser**

C61397 · Collins Floor Lamp

Body: Aged Gunmetal / Metal
 Shade: Tiffany / Glass
 Switch: On/Off Foot
 Lamp: E-27 Medium Base (Max. 60W) x2
 Dimension: 65.5"H x 20.5"W
 Features: **Tiffany Shade, Top Diffuser**

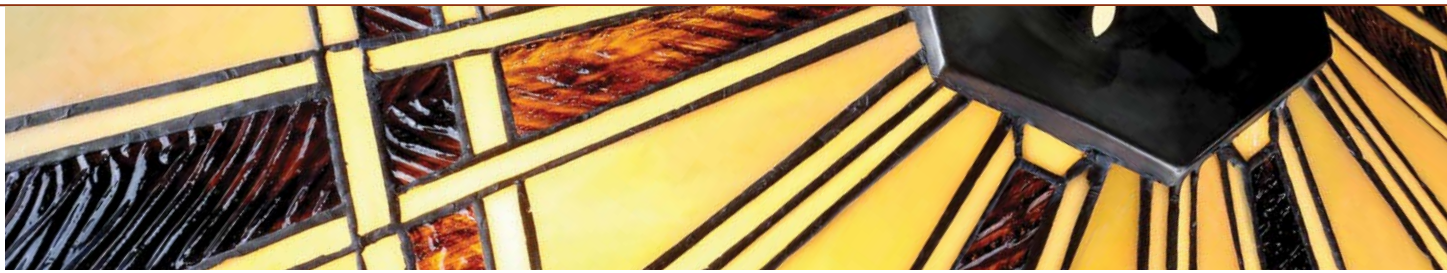

①



③



②

C71392-W ① · Mircea Wall Sconce

Body: Dark Bronze / Metal
 Shade: Tiffany / Glass
 Lamp: E-27 Medium Base (Max. 60W) x2
 Dimension: 10"H x 14.5"W x 4.5"D
 Features: **Tiffany Shade**

C71393 ② · Mircea Semi-Flush Mount

Body: Dark Bronze / Metal
 Shade: Tiffany / Glass
 Lamp: E-27 Medium Base (Max. 60W) x2
 Dimension: 10"H x 15.5"W
 Features: **Tiffany Shade**

C71394 ③ · Mircea Pendant

Body: Dark Bronze / Metal
 Shade: Tiffany / Glass
 Lamp: E-27 Medium Base (Max. 60W) x3
 Dimension: 76"Max. H x 19.5"W
 Features: **Tiffany Shade, Top Diffuser**



C41394 · Mircea Table Lamp

Body: Dark Bronze / Metal
Shade: Tiffany / Glass
Switch: Dual On/Off Pull-Chain
Lamp: E-27 Medium Base (Max. 60W) x2
Dimension: 24”H x 15”W
Features: **Tiffany Shade**

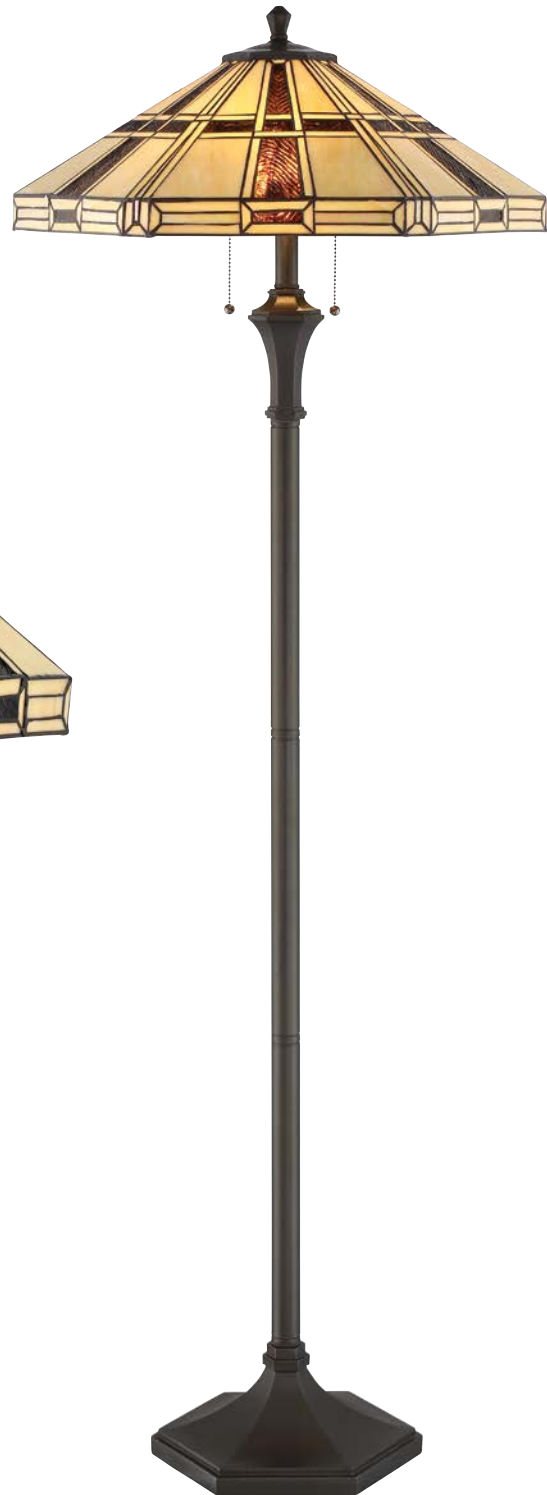

C61394 · Mircea Floor Lamp

Body: Dark Bronze / Metal
Shade: Tiffany / Glass
Switch: Dual On/Off Pull-Chain
Lamp: E-27 Medium Base (Max. 60W) x2
Dimension: 61.5”H x 22”W
Features: **Tiffany Shade**



LS-22040 · Karysa Table Lamp

Body: Dark Bronze / Metal
 Shade: Tiffany / Glass
 Switch: Dual On/Off Pull-Chain
 Lamp: E-27 Medium Base (Max. 60W) x2
 Dimension: 25.5”H x 15”W
 Features: **Tiffany Shade**

LS-82040 · Karysa Floor Lamp

Body: Dark Bronze / Metal
 Shade: Tiffany / Glass
 Switch: Dual On/Off Pull-Chain
 Lamp: E-27 Medium Base (Max. 60W) x2
 Dimension: 60.5”H x 15”W
 Features: **Tiffany Shade**

LS-82041 · Karysa Torchiere Lamp

Body: Dark Bronze / Metal
 Shade: Tiffany / Glass
 Switch: On/Off Socket
 Lamp: E-27 Medium Base (Max. 150W)
 Dimension: 71.5”H x 14”W
 Features: **Tiffany Shade**



C41398 · Brayton Table Lamp

Body: Dark Bronze / Metal
 Shade: Tiffany / Glass
 Switch: Dual Pull-Chain
 Lamp: E-27 Medium Base (Max. 60W) x2
 Dimension: 24.5”H x 16”W
 Features: **Tiffany Shade**

C61398 · Brayton Floor Lamp

Body: Dark Bronze / Metal
 Shade: Tiffany / Glass
 Switch: Dual Pull-Chain
 Lamp: E-27 Medium Base (Max. 60W) x2
 Dimension: 60”H x 16”W
 Features: **Tiffany Shade**

C61399 · Brayton Torchiere Lamp

Body: Dark Bronze / Metal
 Shade: Tiffany / Glass
 Switch: On/Off Socket
 Lamp: E-27 Medium Base (Max. 100W)
 Dimension: 71”H x 15”W
 Features: **Tiffany Shade**



①



②



③



④

C41341 ① · Deana Table Lamp

Body: Dark Bronze / Polyresin
Shade: Tiffany / Glass
Switch: Dual On/Off Pull-Chain
Lamp: E-27 Medium Base (Max. 60W) x2
Dimension: 25”H x 16”Dia.
Features: **Tiffany Shade**

C41385 ② · Odetta Table Lamp

Body: Dark Bronze / Metal
Shade: Tiffany / Glass
Switch: Dual On/Off Pull-Chain
Lamp: E-27 Medium Base (Max. 60W) x2
Dimension: 25.5”H x 15.5”Dia.
Features: **Tiffany Shade**

C41386 ③ · Olivia Table Lamp

Body: Dark Bronze / Metal
Shade: Tiffany / Glass
Switch: Dual On/Off Pull-Chain
Lamp: E-27 Medium Base (Max. 60W) x2
Dimension: 25”H x 14”W
Features: **Tiffany Shade**

C41389 ④ · Lance Table Lamp

Body: Dark Bronze / Metal
Shade: Tiffany / Glass
Switch: Dual On/Off Pull-Chain
Lamp: E-27 Medium Base (Max. 60W) x2
Dimension: 25.5”H x 14”W
Features: **Tiffany Shade**



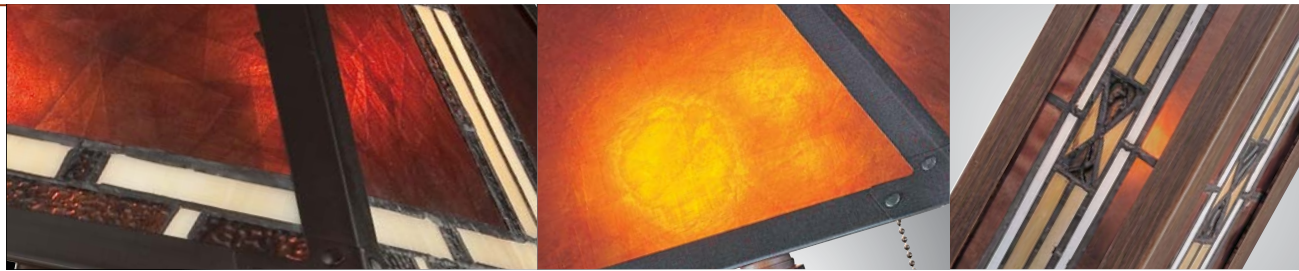

C41267 ① · Crimson Table Lamp

Body: Dark Bronze / Polyresin
 Shade: Tiffany / Mica
 Switch: Dual On/Off Pull-Chain
 Lamp: E-27 Medium Base (Max. 60W) x2
 Dimension: 24.5"H x 16"W
 Features: **Tiffany Shade**

LS-20474 ② · Micah Table Lamp

Body: Walnut Wood / Dark Bronze Metal
 Shade: Dark Amber / Mica
 Switch: Dual On/Off Pull-Chain
 Lamp: E-27 Medium Base (Max. 60W) x2
 Dimension: 26.5"H x 16"W
 Features: **Mica Shade**

LS-20812 ③ · Farah Table Lamp

Body: Dark Bronze Metal / Tiffany Glass
 Shade: Tiffany / Glass
 Switch: 3-Way Rotary on Base
 Main Lamp: E-27 Medium Base (Max. 60W) x2
 Nightlight: E-12 Candelabra Base (Max. 7W)
 Dimension: 25.5"H x 16"W
 Features: **Tiffany Shade, Nightlight**

LS-21437 ④ · Mischa Table Lamp

Body: Dark Bronze / Metal
 Shade: Dark Amber / Mica
 Switch: Dual On/Off Pull-Chain
 Lamp: E-27 Medium Base (Max. 60W) x2
 Dimension: 26"H x 18.5"W
 Features: **Mica Shade**

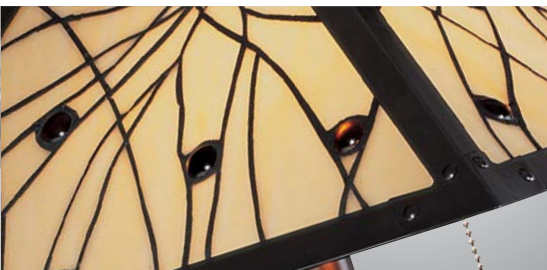

RE
MU
S
HA
LDEN
HA
DRIA
AR
TY



①



②



③



④

C41117 ① · Remus Table Lamp

Body: Antique Bronze / Polyresin
Shade: Tiffany / Glass
Switch: Dual On/Off Pull-Chain
Lamp: E-27 Medium Base (Max. 60W) x2
Dimension: 29.5"H x 16"W
Features: **Tiffany Shade**

C41383 ② · Halden Table Lamp

Body: Dark Bronze / Metal
Shade: Tiffany / Mica
Switch: Dual On/Off Pull-Chain
Lamp: E-27 Medium Base (Max. 60W) x2
Dimension: 24"H x 16"W
Features: **Tiffany Shade**

C41384 ③ · Hadria Table Lamp

Body: Dark Bronze / Metal
Shade: Tiffany / Glass
Switch: Dual On/Off Pull-Chain
Lamp: E-27 Medium Base (Max. 60W) x2
Dimension: 25"H x 15"W
Features: **Tiffany Shade**

LS-22260 ④ · Arty Table Lamp

Body: Dark Bronze / Metal
Shade: Tiffany / Glass
Switch: Dual On/Off Pull-Chain
Lamp: E-27 Medium Base (Max. 60W) x2
Dimension: 27"H x 16"W
Features: **Tiffany Shade**

TRADITIONAL



**C41151** · Bandele Table Lamp

Body: Dark Bronze / Metal
Shade: Tan w. Black Trim / Fabric
Switch: 3-Way Socket
Lamp: E-27 Medium Base
Dimension: 27.5"H x 13"W
Features: Max. 150W

**C61151** · Bandele Floor Lamp

Body: Dark Bronze / Metal
Shade: Tan w. Black Trim / Fabric
Switch: 3-Way Socket
Lamp: E-27 Medium Base
Dimension: 58.5"H x 13.5"W
Features: Max. 150W

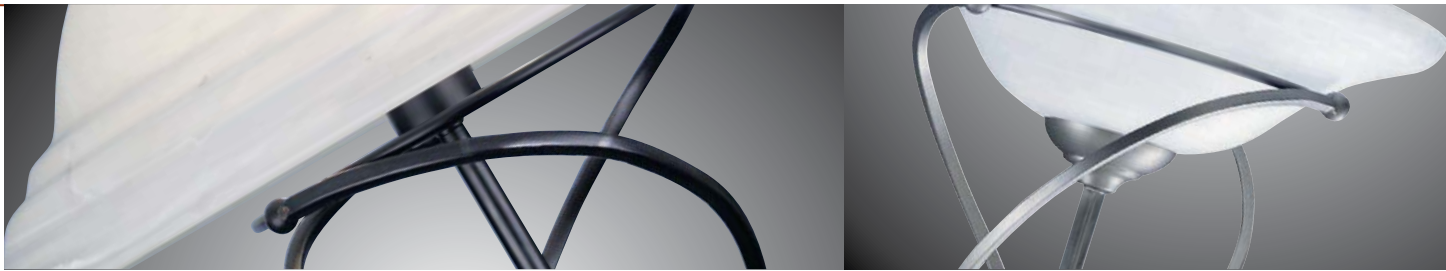

LS-3640BLK ① · Majesty Table Lamp

Body: Black / Metal
 Shade: Cloud / Glass
 Switch: On/Off In-Line
 Lamp: E-27 Medium Base (Max. 60W) x2

LS-9640BLK ② / LS-9640D/BRZ ③ / LS-9640SS ④ · Majesty Torchiere Lamp

Body: Black, Dark Bronze or Satin Steel / Metal
 Shade: Cloud / Glass
 Switch: 3-Way on Pole
 Bulb Base: E-27 Medium Base (Max. 150W)
 Features: **3-Way Switch**

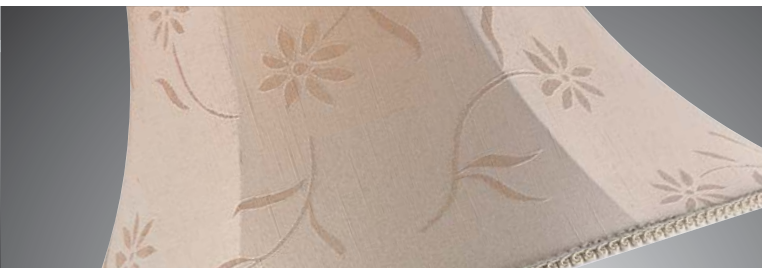

C4333 · Savoir Faire Table Lamp

Body: Antique Bronze & Gold Finish Polyresin / Reverse Painted Glass Accent
 Shade: Jacquard / Fabric
 Switch: 3-Way Socket
 Bulb Base: E-27 Medium Base (Max. 150W)
 Dimension: 29.5"H x 16.5"Dia.
 Features: **3-Way Switch**



C6333 · Savoir Faire Floor Lamp

Body: Antique Bronze & Gold Finish Polyresin / Reverse Painted Glass Accent
 Shade: Jacquard / Fabric
 Switch: 3-Way Socket
 Bulb Base: E-27 Medium Base (Max. 150W)
 Dimension: 59"H x 16"Dia.
 Features: **3-Way Switch**



C6334 · Savoir Faire Torchiere Lamp

Body: Antique Bronze & Gold Finish Polyresin / Reverse Painted Glass Accent
 Shade: Dark Amber Cloud / Glass
 Switch: 3-Way Socket
 Bulb Base: E-27 Medium Base (Max. 150W)
 Dimension: 70"H x 14.5"Dia.
 Features: **3-Way Switch**



LS-22303 ① · Lavache Table Lamp

Body: Chrome Metal / Clear Crystal
 Shade: Black Transparent / Mylar
 Switch: Dimmer In-Line
 Lamp: E-12 Candelabra Base (Max. 25W) x5
 Dimension: 30"H x 16"Dia.
 Features: **Dimmer Switch**

LS-22788 ② · Camila Table Lamp

Body: Chrome / Metal
 Shade: Off-White / Fabric
 Switch: On/Off Socket
 Bulb Base: E-27 Medium Base (Max. 100W)
 Dimension: 29.5"H x 16"Dia.

LS-82788 ③ · Camila Floor Lamp

Body: Chrome / Metal
 Shade: Off-White / Fabric
 Switch: On/Off Socket
 Bulb Base: E-27 Medium Base (Max. 100W)
 Dimension: 58.5"H x 17"Dia.

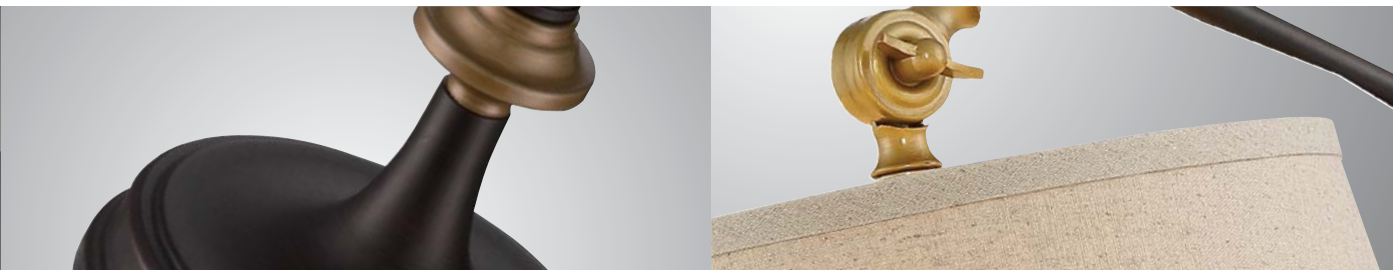

LAKEN
HEINZ



LS-22787 ① · Laken Table Lamp

Body: Dark Bronze w. Aged Gold / Metal
 Shade: Off-White / Fabric
 Switch: On/Off Socket
 Bulb Base: E-27 Medium Base (Max. 60W)
 Dimension: 33”H x 12”Dia.

LS-22834 ② · Heinz Table Lamp

Body: Burnished Bronze w. Aged Gold / Metal
 Shade: Linen / Fabric
 Switch: On/Off Socket
 Bulb Base: E-27 Medium Base (Max. 100W)
 Dimension: 26.5”H x 20”W
 Features: **Adjustable Shade**

LS-82834 ③ · Heinz Floor Lamp

Body: Burnished Bronze w. Aged Gold / Metal
 Shade: Linen / Fabric
 Switch: On/Off Socket
 Bulb Base: E-27 Medium Base (Max. 100W)
 Dimension: 57.5”H x 21”W
 Features: **Adjustable Shade**

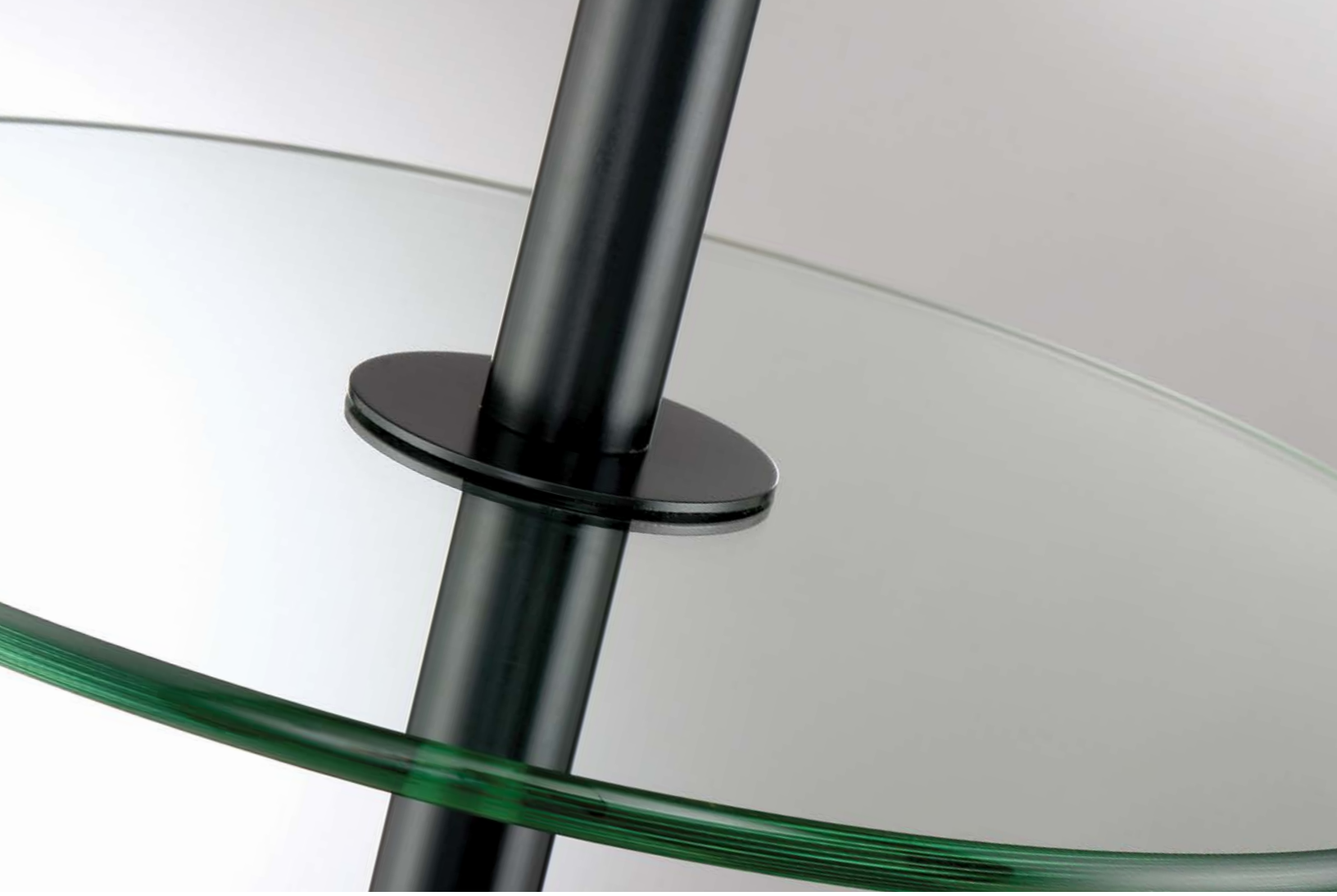

**LS-23052** · Camberley Table Lamp

Body: Dark Bronze / Metal
 Shade: Light Beige / Fabric
 Switch: On/Off Socket

Bulb Base: E-27 Medium Base (Max. 100W)
 Dimension: 35"Max. H x 19.5"Max. Reach
 Features: **Swing-Arm, Adjustable Height**

LS-83052 · Camberley Floor Lamp

Body: Dark Bronze / Metal
 Shade: Light Beige / Fabric
 Switch: On/Off Socket

Bulb Base: E-27 Medium Base (Max. 100W)
 Dimension: 62.5"Max. H x 23.5"Max. Reach
 Features: **Swing-Arm, Adjustable Height**

LS-83053 · Camberley Floor Lamp w. Table

Body: Dark Bronze / Metal
 Shade: Light Beige / Fabric
 Switch: On/Off Socket

Bulb Base: E-27 Medium Base (Max. 100W)
 Dimension: 62.5"Max. H x 23.5"Max. Reach
 Features: **Swing-Arm, Adjustable Height, Clear Glass Table Top**



①



②



③



④

C41320 ① · Bishop Table Lamp

Body: Rusted Champagne Silver / Reverse Painted Glass
 Shade: Linen w. Black Trim / Fabric
 Switch: On/Off Socket
 Lamp: E-27 Medium Base (Max. 100W)
 Dimension: 30.5"H x 16"Dia.
 Features: **Reverse Painted Glass**

C41362 ② · Samson Table Lamp

Body: Antique Bronze / Polyresin
 Shade: Light Beige / Fabric
 Switch: On/Off Socket
 Lamp: E-27 Medium Base (Max. 60W)
 Dimension: 26.5"H x 12"Dia.

LS-20847D/BRZ ③ · Breyon Table Lamp

Body: Dark Bronze / Metal
 Shade: Linen / Fabric
 Switch: 3-Way Socket
 Lamp: E-27 Medium Base (Max. 100W)
 Dimension: 30.5"H x 15.5"Dia.
 Features: **3-Way Switch**

LS-22831 ④ · Avaline Table Lamp

Body: Champagne Tone / Glass
 Shade: Off-White / Fabric
 Switch: On/Off Socket
 Lamp: E-27 Medium Base (Max. 100W)
 Dimension: 28.5"H x 15"Dia.

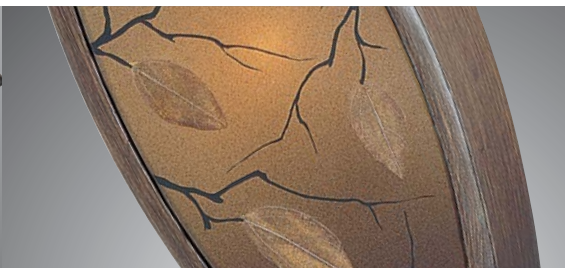
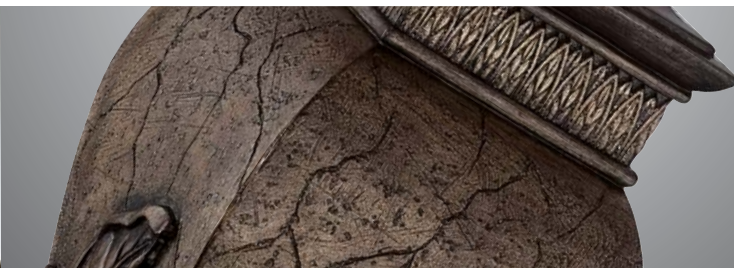

J A Q U A N
P A U L E T T E
C R E I G H T O N
N A T A L I E



C41160 ① · Jaquan Table Lamp

Body: Walnut Wood / Reverse Painted Glass
Shade: Beige / Fabric
Switch: 3-Way Socket
Main Lamp: E-27 Medium Base (Max. 150W)
Nightlight: E-12 Candelabra Base (Max. 7W)
Dimension: 30.5”H x 17”W
Features: **Nightlight, 3-Way Switch, Reverse Painted Glass**

C41225 ② · Paulette Table Lamp

Body: Aged Silver / Polyresin
Shade: Light Grey / Fabric
Switch: Off/On Socket
Lamp: E-27 Medium Base (Max. 100W)
Dimension: 31”H x 15”W

C41294 ③ · Creighton Table Lamp

Body: Faux Marble / Antique Bronze
Shade: Linen / Fabric
Switch: 3-Way Socket
Lamp: E-27 Medium Base (Max. 150W)
Dimension: 32.5”H x 16”Dia.
Features: **3-Way Switch**

C41344 ④ · Natalie Table Lamp

Body: Aged Bronze Finish Polyresin / 2-Tone Amber Sand Finish Glass
Shade: Light Beige / Faux Silk
Switch: 3-Way Socket
Main Lamp: E-27 Medium Base (Max. 150W)
Nightlight: 0.5W LED
Dimension: 33”H x 17”Dia.
Features: **3-Way Switch, Nightlight**

TRADITIONAL

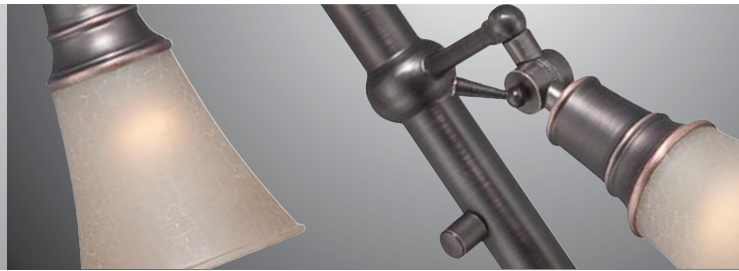

①



②



③

C61289 ① · Guildford Torchiere Lamp

Body: Dark Bronze & Antique Gold / Metal
Shade: Frosted / Glass
Switch: 3-Way Socket
Bulb Base: E-27 Medium Base (Max. 100W)
Dimension: 71.5"H x 16"Dia.
Features: **3-Way Switch**

LS-80442D/BRZ ② · Zesiro Torchiere/Reading Lamp

Body: Dark Bronze / Metal
Shade: Mottled Amber / Glass
Switch: Dual On/Off Rotary on Pole
Main Lamp: E-27 Medium Base (Max. 150W)
Reading Lamp: E-12 Candelabra Base (Max. 60W)
Dimension: 71.5"H x 13"W
Features: **Adjustable Reading Lamp**

LS-81942 ③ · Mercede Floor Lamp

Body: Antique Copper / Metal
Shade: Tea Stained / Glass
Switch: 3-Way Rotary on Pole
Bulb Base: E-27 Medium Base (Max. 40W) x3
Dimension: 68.5"H x 23.5"W
Features: **Adjustable Shades**



BRANDICE
LAURENCE

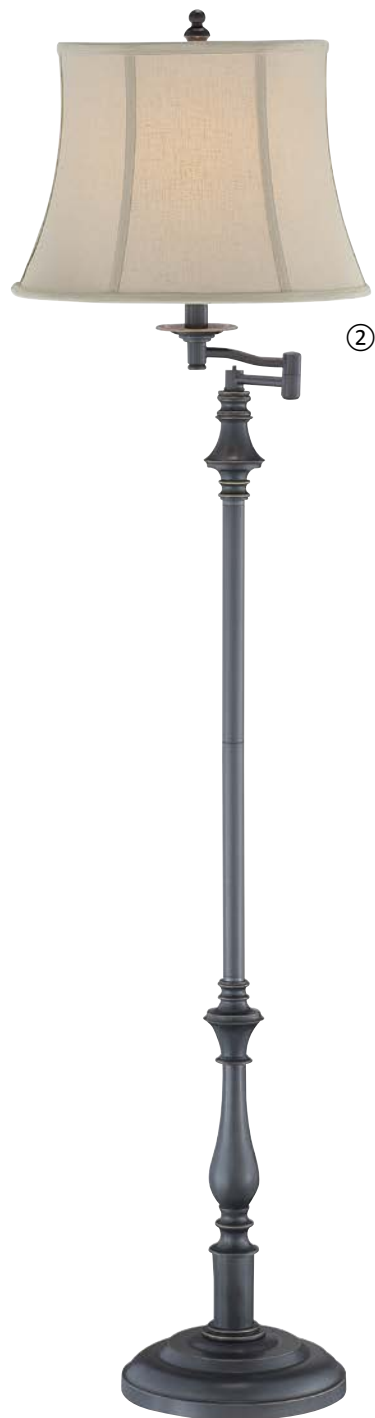

C61195 ① · Brandice Floor Lamp
Body: Black Bronze Metal / Glass Table
Shade: Off-White / Fabric
Switch: On/Off Socket
Bulb Base: E-27 Medium Base (Max. 100W)
Dimension: 62"H x 16"W
Features: **Swing Arm, Clear Glass Tray Table**

LS-81832 ② · Laurence Floor Lamp
Body: Dark Bronze / Metal
Shade: Light Beige / Fabric
Switch: 3-Way Socket
Bulb Base: E-27 Medium Base (Max. 100W)
Dimension: 60.5"H x 17.5"W
Features: **3-Way Switch, Swing Arm**

TRADITIONAL

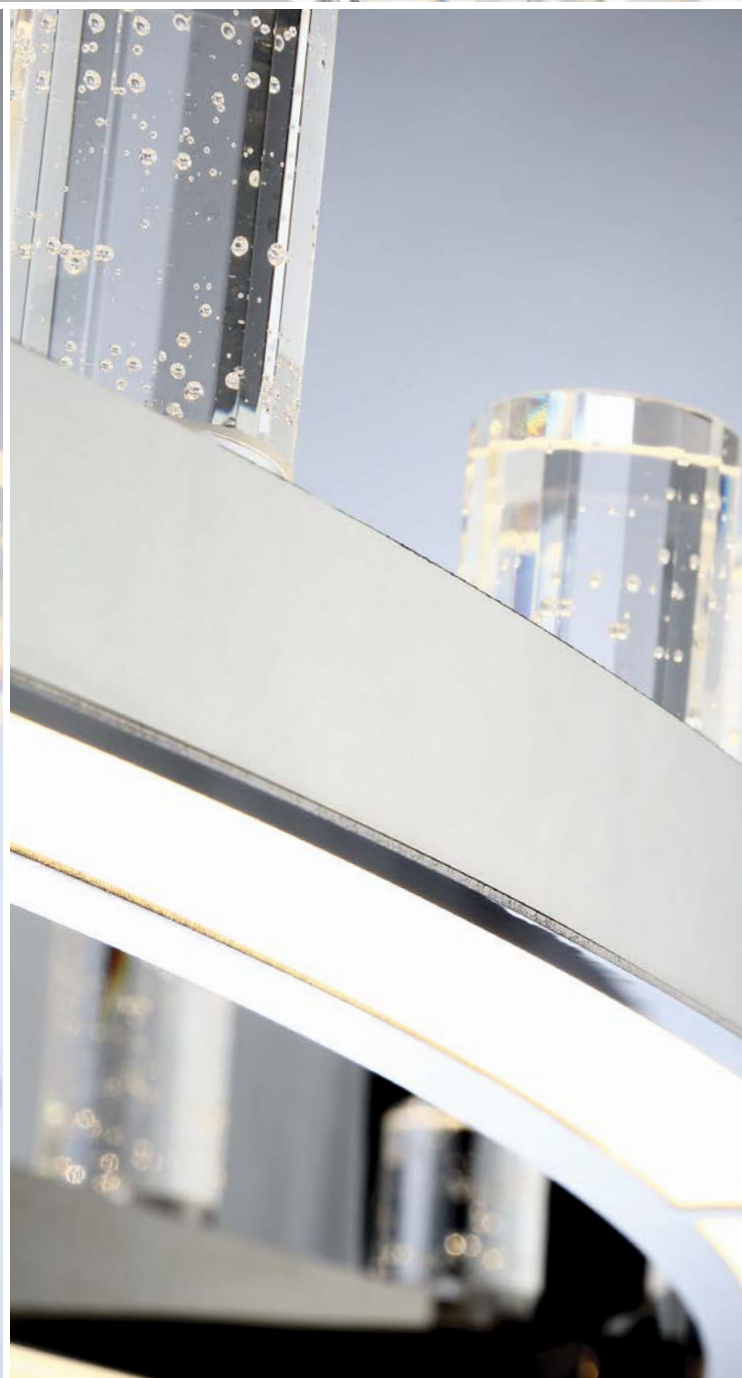
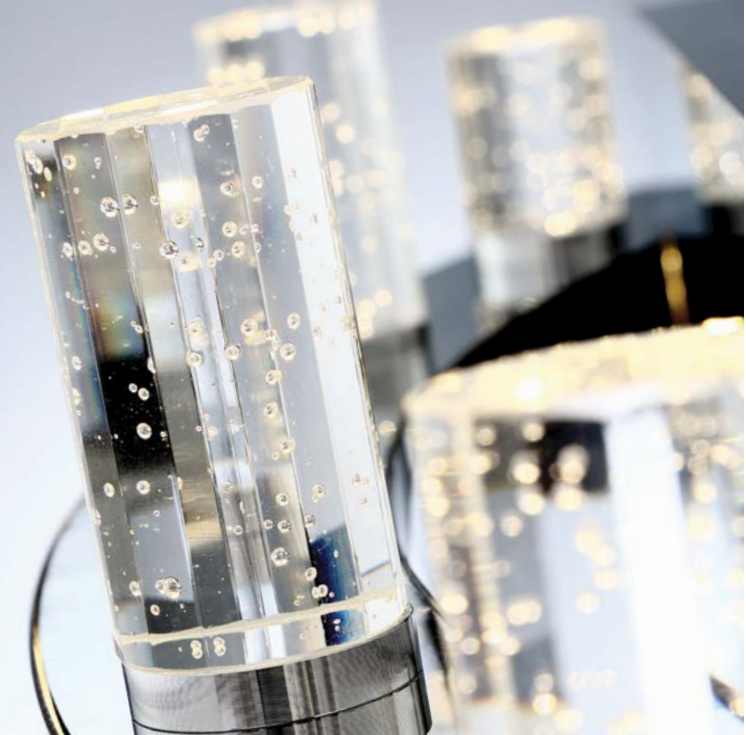



①



②

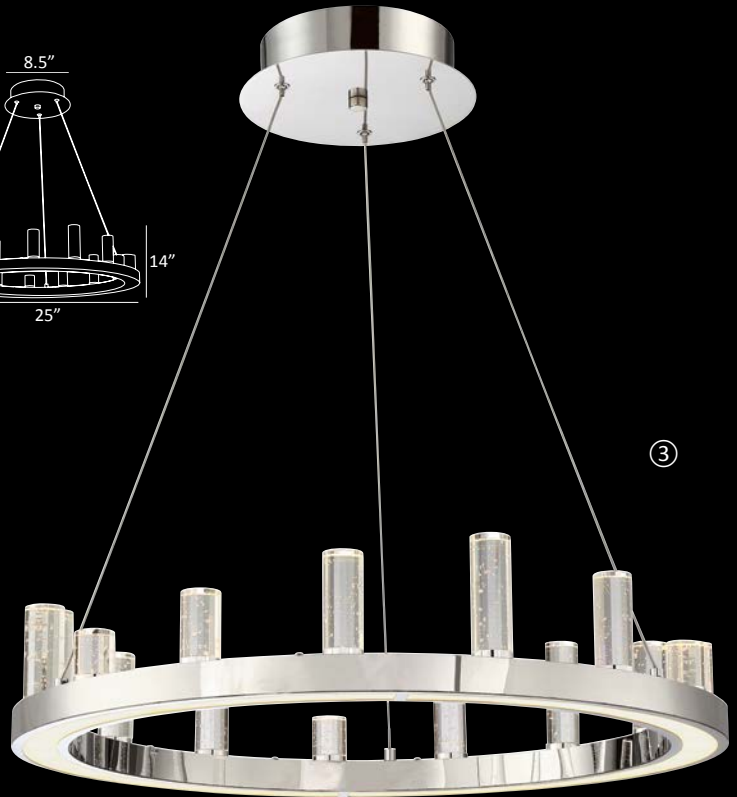
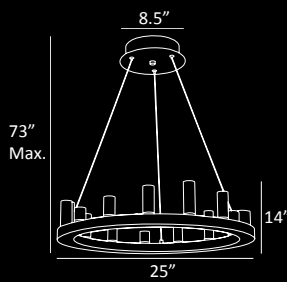

③

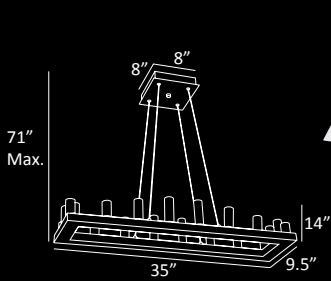

④

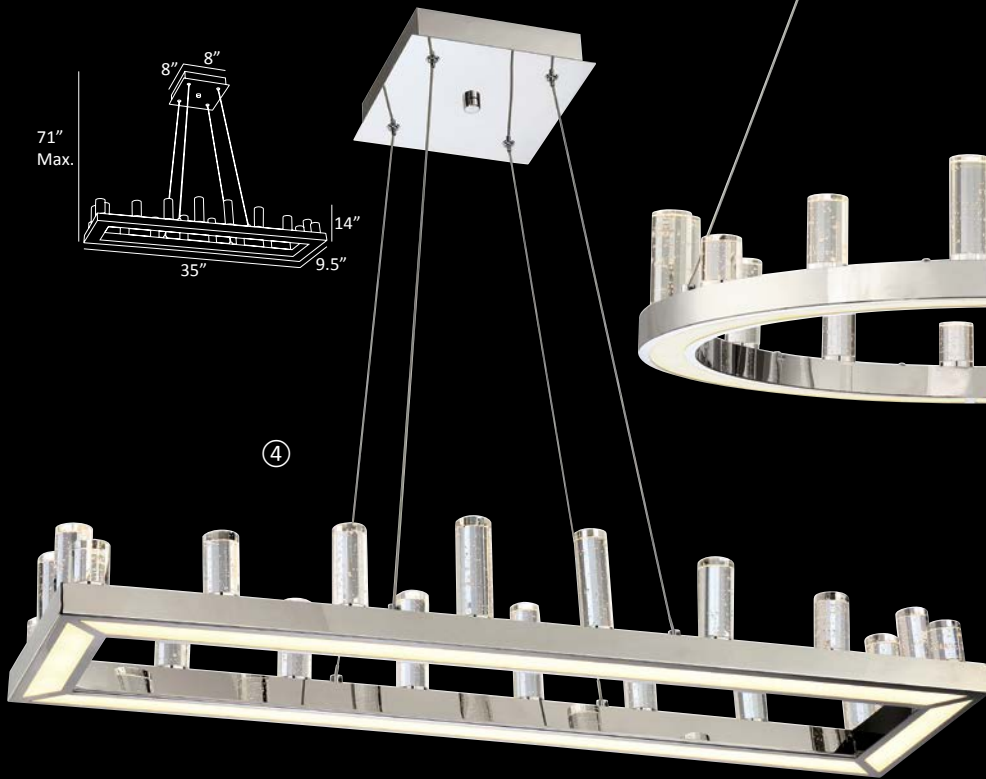

LS-16220 ①

LS-16221 ② · Elina LED Wall Sconce

Body: Chrome / Metal

Shade: Seeded / Crystal

Lamp: 18W or 26W LED Panel

(3000K, 1280lm or 1840lm, CRI: 80)

Features: Seeded Crystal, Dimmable & Replaceable LED Included

LS-19221 ③

LS-19222 ④ · Elina LED Chandelier

Body: Chrome / Metal

Shade: Seeded / Crystal

Lamp: 47W or 49W LED Panel

(3000K, 3600lm, CRI: 80)

Features: Seeded Crystal, Adjustable Height, Dimmable & Replaceable LED Included

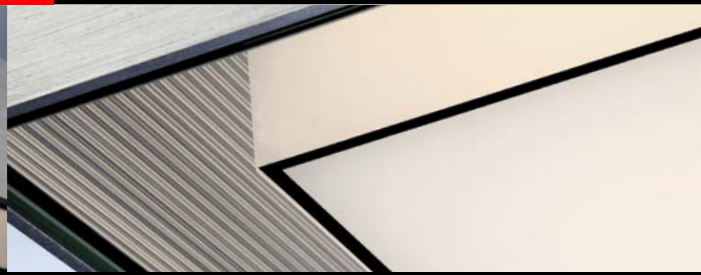
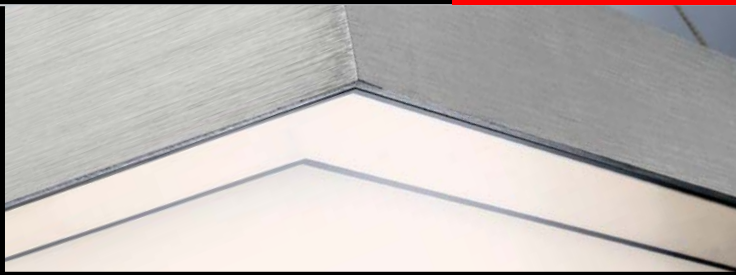

①

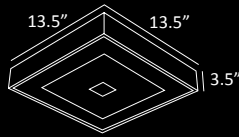

②



③

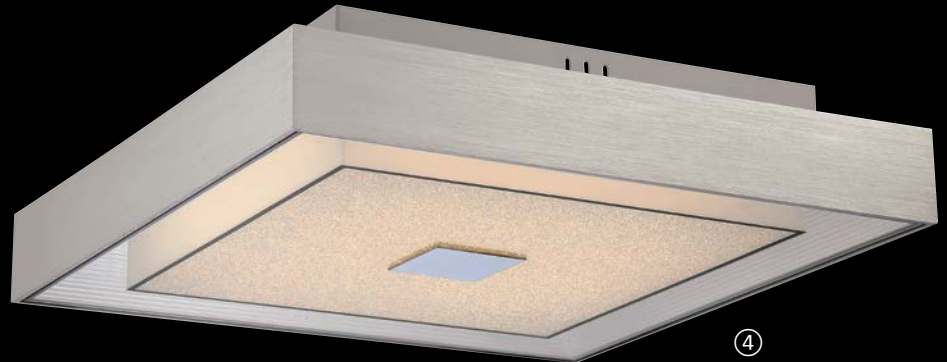
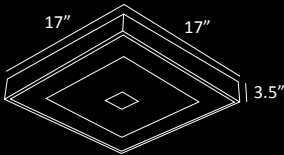

④

LS-5915 ①

LS-5915DIAMOND ② · Halona LED Flush Mount

Body: Chrome & Aluminum / Metal

Shade: Frosted or Diamond Seeded / Glass

Lamp: 12W LED (3000K, 1000lm, CRI: 80)

Features: **Diamond Glass, Dimmable & Replaceable LED Included**

LS-5916 ③

LS-5916DIAMOND ④ · Halona LED Flush Mount

Body: Chrome & Aluminum / Metal

Shade: Frosted or Diamond Seeded / Glass

Lamp: 20W LED (3000K, 1600lm, CRI: 80)

Features: **Diamond Glass, Dimmable & Replaceable LED Included**

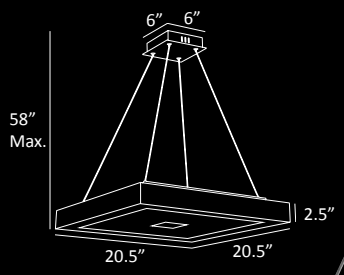

LS-19516 ①

LS-19516DIAMOND ② · Halona LED Pendant

Body: Chrome & Aluminum / Metal

Shade: Frosted or Diamond Seeded / Glass

Lamp: 26W LED (3000K, 2020lm, CRI: 80)

Features: **Diamond Glass, Adjustable Height, Dimmable & Replaceable LED Included**



①

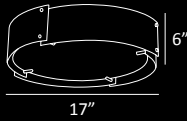

②

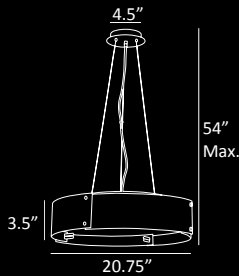
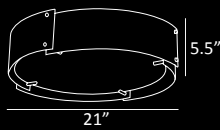

③



LS-5419C/FRO ①
LS-5420C/FRO ② · Kaelin Flush Mount
 Hardware: Chrome / Metal
 Shade: Frosted w. Texture / Glass
 Lamp: E-27 Medium Base (Max. 60W) x3
 Features: **Glass Diffuser**

LS-19420C/FRO ③ · Kaelin Pendant
 Hardware: Chrome / Metal
 Shade: Frosted w. Texture / Glass
 Lamp: E-27 Medium Base (Max. 60W) x3
 Features: **Glass Diffuser, Adjustable Height**



LS-5419DIAMOND ①
LS-5420DIAMOND ② · Kaelin LED Flush Mount
 Hardware: Chrome / Metal
 Shade: Diamond Seeded / Glass
 Lamp: 20W ① or 30W ② LED Panel
 (3000K, 1096lm ① or 1634lm ②, CRI: 80)
 Features: **Diamond Glass, Dimmable LED Included**

LS-19420DIAMOND ③ · Kaelin LED Pendant
 Hardware: Chrome / Metal
 Shade: Diamond Seeded / Glass
 Lamp: 30W LED Panel
 (3000K, 1096lm or 1634lm, CRI: 80)
 Features: **Diamond Glass, Dimmable LED Included, Adjustable Height**





Semi-Flush Mount Convertable



EL-10174 ①

EL-10175 ② · Glennis 5-Lite Pendant

Body: Chrome / Metal

Shade: Water Glass / Glass

Lamp: E-12 Candelabra Base (Max. 60W) x5

Dimensions: 60.5"H x 24.5"Dia. ① 60"H x 36"W x 14"D ②

Features: **Water Glass, Adjustable Height**

EL-50174 ③ · Glennis 3-Lite Pendant / Semi-Flush Mount

Body: Chrome / Metal

Shade: Water Glass / Glass

Lamp: E-12 Candelabra Base (Max. 60W) x3

Dimension: 72.5"Max.(14"Min.) H x 16"Dia.

Features: **Water Glass, Adjustable Height, Convertable**

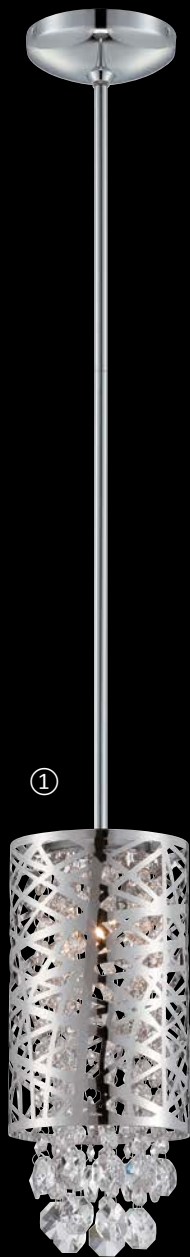

①



③



②

EL-10100 ① · Benedetta Mini Pendant

Body: Chrome / Metal
 Décor: Full-Cut / Crystal
 Lamp: JCD/G9 Halogen (Max. 50W) x2
 Dimensions: 63.25"H x 6"Dia.
 Features: **Crystal Droplets**

EL-10101 ② · Benedetta Pendant

Body: Chrome / Metal
 Décor: Full-Cut / Crystal
 Lamp: JCD/G9 Halogen (Max. 50W) x4
 Dimensions: 60.25"H x 16"Dia.
 Features: **Crystal Droplets**

EL-50100 ③ · Benedetta Semi-Flush Mount

Body: Chrome / Metal
 Décor: Full-Cut / Crystal
 Lamp: JCD/G9 Halogen (Max. 50W) x4
 Dimensions: 19.5"H x 14"Dia.
 Features: **Crystal Droplets**

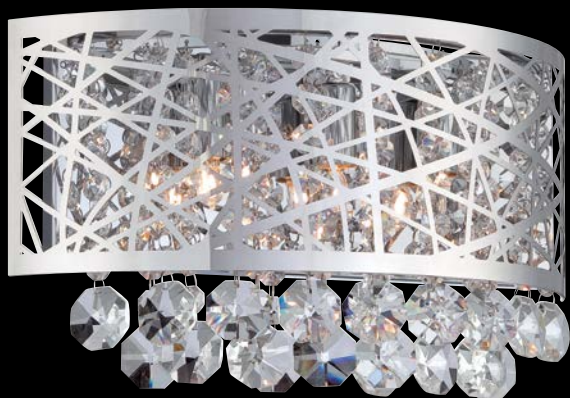

①



②

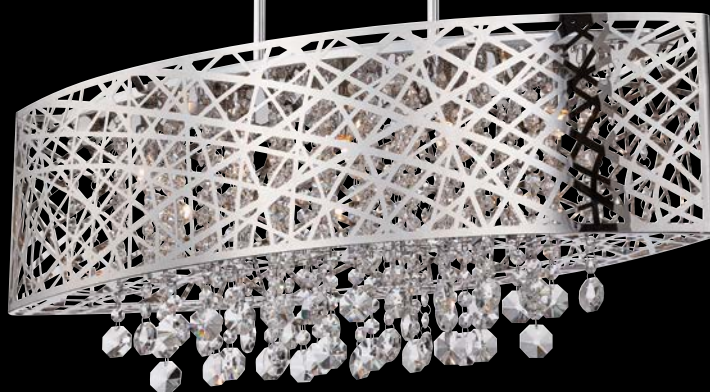

③



EL-10102 ① · Benedetta Sconce

Body: Chrome / Metal
 Décor: Full-Cut / Crystal
 Lamp: JCD/G9 Halogen (Max. 25W) x3
 Dimensions: 11.5"H x 12"W x 4"D
 Features: **Crystal Droplets, ADA**

EL-10103 ② · Benedetta Pendant

Body: Chrome / Metal
 Décor: Full-Cut / Crystal
 Lamp: JCD/G9 Halogen (Max. 50W) x5
 Dimensions: 61"Max. H x 30"W x 9"D
 Features: **Crystal Droplets, Adjustable Height**

EL-10104 ③ · Benedetta Pendant

Body: Chrome / Metal
 Décor: Full-Cut / Crystal
 Lamp: JCD/G9 Halogen (Max. 50W) x10
 Dimensions: 58.5"Max. H x 36"W x 14"D
 Features: **Crystal Droplets, Adjustable Height**

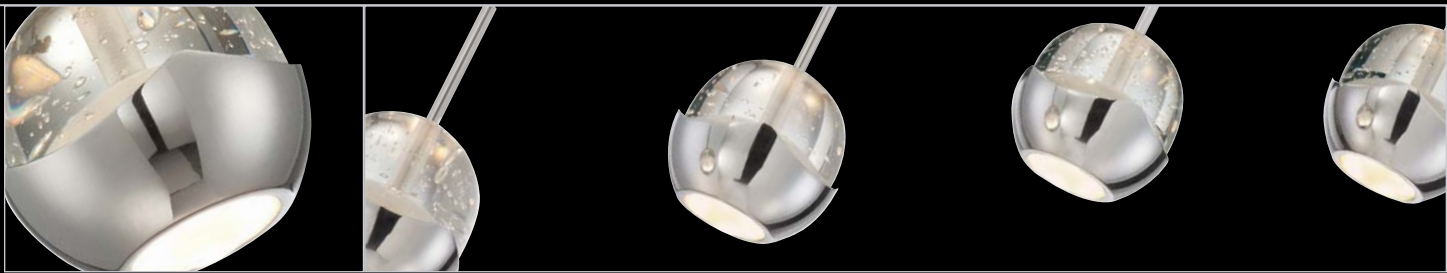

LS-18191 ① · Draplin Mini Pendant
 Body: Chrome / Metal
 Shade: Seeded / Crystal
 Lamp: 6W LED (3000K, 480lm, CRI: 80)
 Features: **Seeded Crystal,**
Replaceable & Dimmable LED

LS-18194 ② · Draplin Pendant
 Body: Chrome / Metal
 Shade: Seeded / Crystal
 Lamp: 6W x4 LED (3000K, 1920lm, CRI: 80)
 Features: **Seeded Crystal,**
Replaceable & Dimmable LED

LS-18195 ③ · Draplin Pendant
 Body: Chrome / Metal
 Shade: Seeded / Crystal
 Lamp: 6W x4 LED (3000K, 1920lm, CRI: 80)
 Features: **Seeded Crystal,**
Replaceable & Dimmable LED

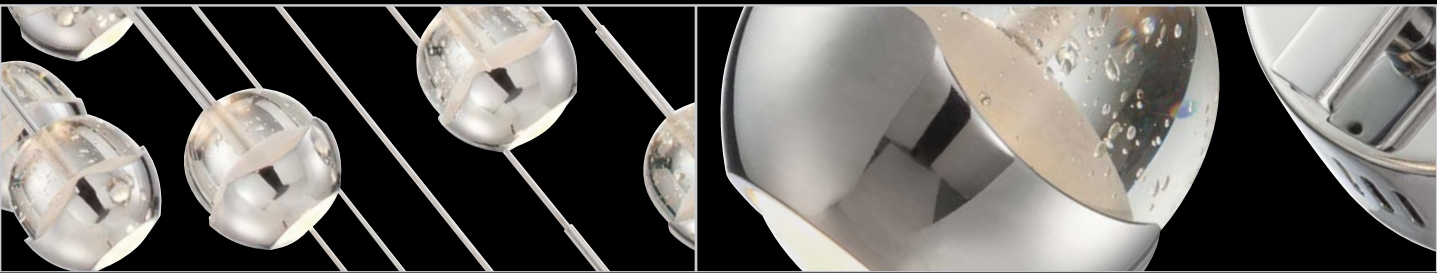

①

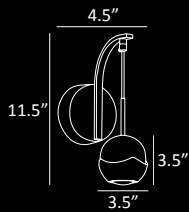

②

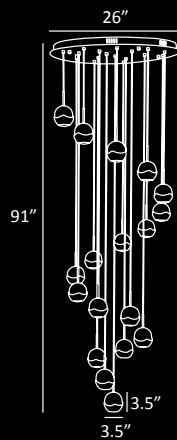

LS-16191 ① · Draplin Wall Lamp

Body: Chrome / Metal
 Shade: Seeded / Crystal
 Lamp: 6W LED (3000K, 480lm, CRI: 80)
 Features: **Seeded Crystal,**
Replaceable & Dimmable LED

LS-18198 ② · Draplin Crystal Chandelier

Body: Chrome / Metal
 Shade: Seeded / Crystal
 Lamp: 6W x18 LED (3000K, 8640lm, CRI: 80)
 Features: **Seeded Crystal,**
Replaceable & Dimmable LED

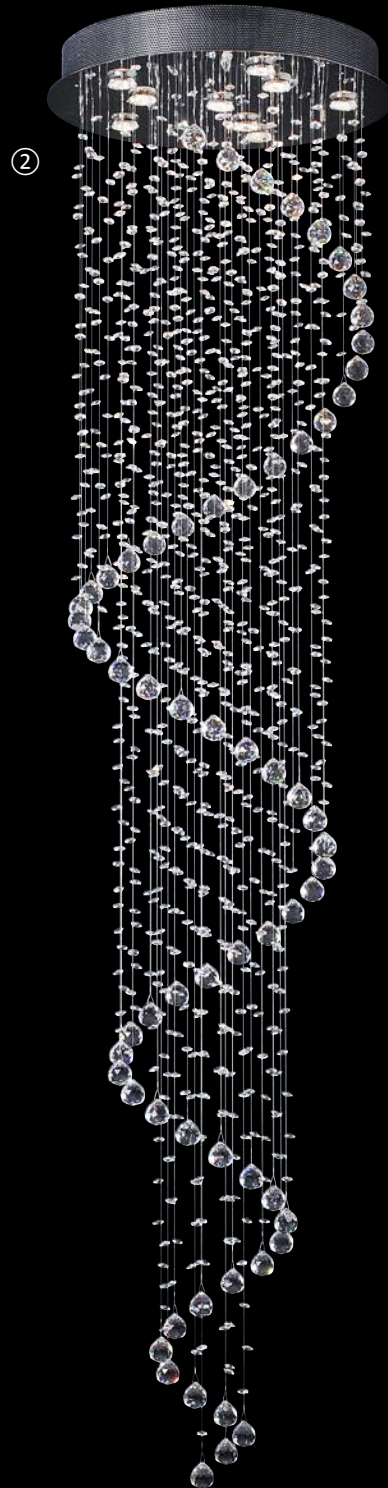
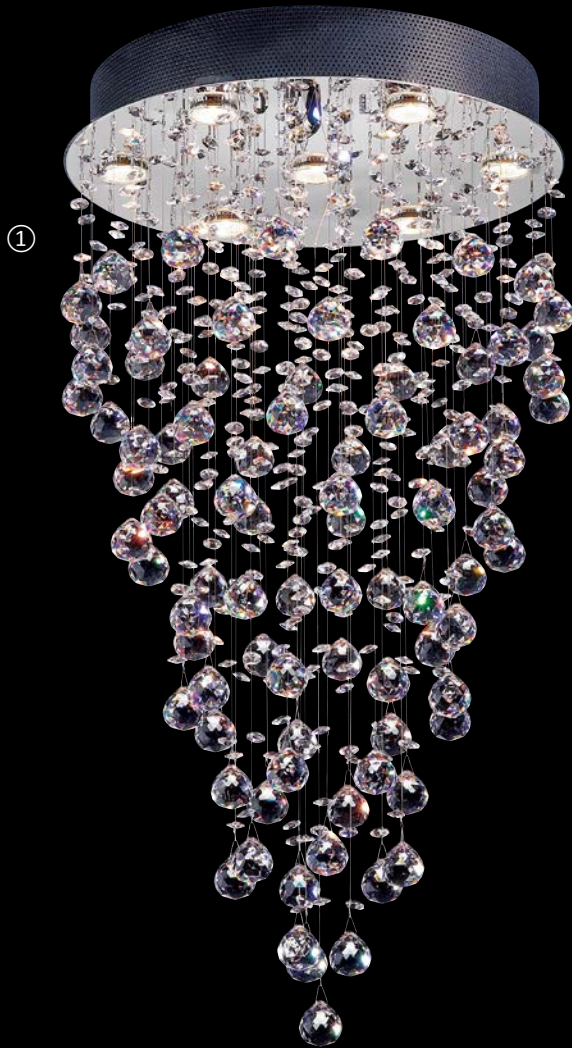

EL-10070 ① · Girolamo Crystal Chandelier

Hardware: Chrome / Metal

Décor: Full-Cut / Crystal

Lamp: GU-10 Halogen (Max. 50W) x7

Dimensions: 39.5" H x 19.75" Dia.

Features: **Crystal Droplets**

EL-10071 ② · Girolamo Crystal Chandelier

Hardware: Chrome / Metal

Décor: Full-Cut / Crystal

Lamp: GU-10 Halogen (Max. 50W) x9

Dimensions: 96.5" H x 23.5" Dia.

Features: **Crystal Droplets**



BUBBLES
MARILYN



①



②

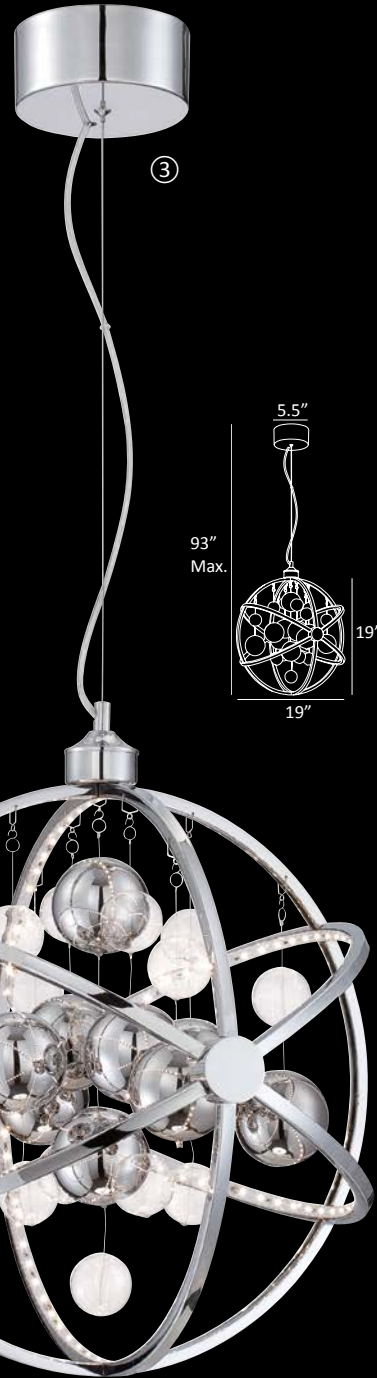

③

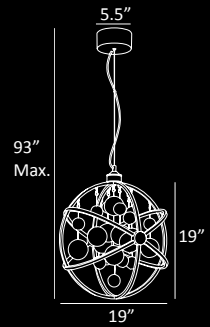

EL-10076 ① · Bubbles Chandelier

Hardware: Chrome / Metal
 Décor: White Frosted Ornaments / Clear Crystal
 Top Lamp: 3W x6 GU-10 LED (4100K, 900lm, CRI: 80)
 Body Lamp: 12V JC/G4 Halogen (Max. 20W) x10
 Dimensions: 98.25" H x 23.5" Dia.
 Features: **Crystal Décor, Replaceable LED**

EL-10077 ② · Bubbles Sconce

Hardware: Chrome / Metal
 Décor: White Frosted Ornaments / Clear Crystal
 Lamp: 12V JC/G4 Halogen (Max. 20W) x6
 Dimensions: 16.5" H x 11.75" W x 7.5" D
 Features: **Crystal Décor**

LS-19577 ③ · Marilyn Pendant

Body: Chrome / Metal
 Décor: Chrome Metal / Clear Glass
 Lamp: 18W LED Panel (3000K, 1800lm, CRI: 80)
 Features: **Replaceable & Dimmable LED**

FIXTURE COLLECTIONS



EL-10165 ① · Lorelle Crystal Chandelier

Hardware: Chrome / Metal
 Décor: Teardrop-Cut / Crystal
 Top Lamp: 4.5W x5 GU-10 LED (3000K, 2000lm, CRI: 70)
 Dimensions: 43.5" H x 17.75" Dia.
 Features: **Crystal Droplets, Replaceable LED**

EL-10166 ② · Lorelle Crystal Chandelier

Hardware: Chrome / Metal
 Décor: Teardrop-Cut / Crystal
 Top Lamp: 4.5W x7 GU-10 LED (3000K, 2800lm, CRI: 70)
 Dimensions: 70" H x 21.5" Dia.
 Features: **Crystal Droplets, Replaceable LED**





LS-5700 ① · Lamont Flush Mount

Hardware: Silver / Metal
 Shade: Frosted w. Clear Edge / Glass
 Lamp: 10W LED (3000K, 800lm, CRI: 80)
 Features: **Replaceable & Dimmable LED**

LS-19570 ② · Lamont Pendant

Hardware: Silver / Metal
 Shade: Frosted w. Clear Edge / Glass
 Lamp: 30W LED (3000K, 2400lm, CRI: 80)
 Features: **Replaceable & Dimmable LED, Adjustable Height**

LS-5707 ③

LS-5708 ④ · Idonia Flush Mount

Hardware: Silver / Metal
 Shade: Frosted w. Clear Edge / Glass
 Lamp: 4.4W ③ / 6W ④ LED (3000K, 360lm ③ / 480lm ④, CRI: 80)
 Features: **Replaceable LED**

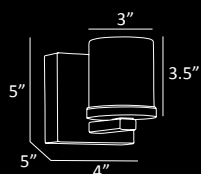

①

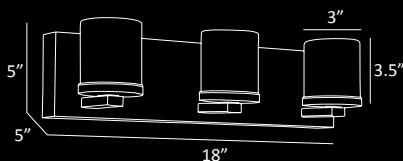

②



Convertible Vanity

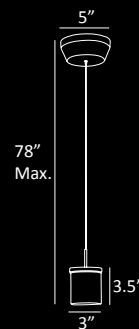

③

LS-16581 ① · Kristen Sconce

Hardware: Chrome / Metal
 Shade: Clear w. Crystal Inside / Glass
 Lamp: 6W LED (3000K, 620lm, CRI: 80)
 Features: **Crystal Accent**

LS-16583 ② · Kristen 3-Lite Vanity

Hardware: Chrome / Metal
 Shade: Clear w. Crystal Inside / Glass
 Lamp: 6W x3 LED (3000K, 1620lm, CRI: 80)
 Features: **Crystal Accent, Convertable**

LS-19581 ③ · Kristen Pendant

Hardware: Chrome / Metal
 Shade: Clear w. Crystal Inside / Glass
 Lamp: 6W LED (3000K, 620lm, CRI: 80)
 Features: **Crystal Accent, Adjustable Height**



LS-19041 ① / LS-19043 ② / LS-19045 ③
· Fruma Pendant

Hardware: Chrome / Metal
Shade: Frosted w. Clear Edge / Glass
Lamp: 5W ① / 5Wx3 ② / 5Wx5 ③ LED
(3000K, 400lm ① 1200lm ② 2000lm ③, CRI: 80)
Features: **Replaceable & Dimmable LED, Adjustable Heights**

LS-19368 ④ · Lexa Mini-Pendant

Hardware: Brushed Nickel / Metal
Shade: Frosted w. Clear Edge / Glass
Lamp: 6W LED (3000K, 330lm, CRI: 80)
Features: **Adjustable Height**

LS-19998 ⑤ · Elettra Mini-Pendant

Hardware: Chrome / Metal
Shade: Frosted w. Clear Edge / Glass
Lamp: 3W LED (3000K, 170lm, CRI: 80)
Features: **Adjustable Height**

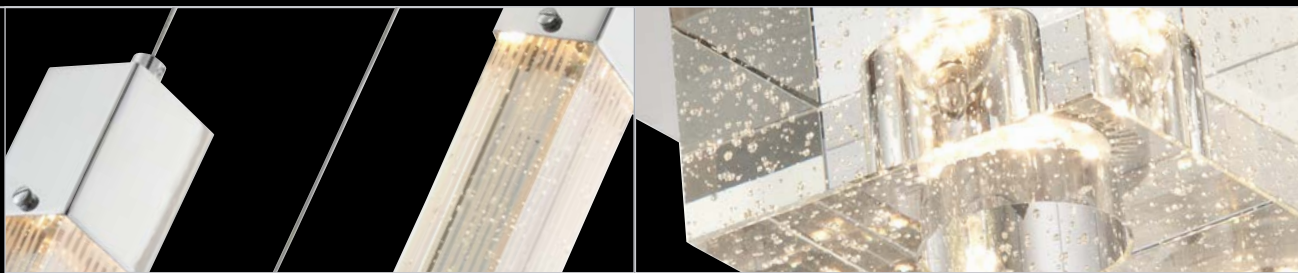

ICE CUBE II
GALLEN
TOTIE



LS-14631LED ① · Ice Cube II Mini-Pendant

Hardware: Brushed Nickel / Metal
Shade: Clear / Glass
Lamp: 3W LED (3000K, 200lm, CRI: 80)
Features: **Adjustable Height**

LS-5620 ② · Galen Flush Mount

Hardware: Chrome / Metal
Shade: Seeded / Crystal
Lamp: 5W LED (3000K, 400lm, CRI: 80)
Features: **Replaceable & Dimmable LED, Seeded Crystal**

LS-19037 ③

LS-19038 ④ · Totie Pendant

Hardware: Chrome / Metal
Shade: Seeded / Crystal
Lamp: 5W ③ / 3Wx3 ④ LED
(3000K, 400lm ③ 700lm ④, CRI: 80)
Features: **Replaceable & Dimmable LED, Seeded Crystal**

FIXTURE COLLECTIONS





①

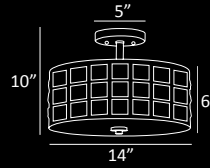

②

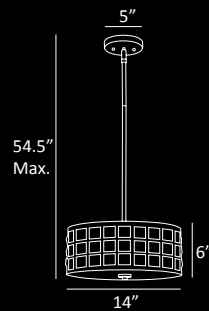
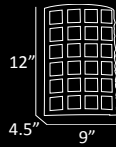

③

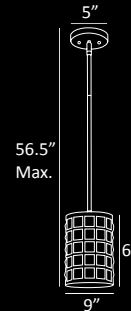

④



LS-5822 ① · Damond Semi-Flush Mount

Hardware: Chrome / Metal
 Shade: Clear / Crystal
 Lamp: E-27 Medium Base (Max. 100W) x2
 Features: **Crystal Accent, Frosted Diffuser**

LS-16822 ② · Damond Scence

Hardware: Chrome / Metal
 Shade: Clear / Crystal
 Lamp: E-27 Medium Base (Max. 100W)
 Features: **Crystal Accent**

LS-19821 ③

LS-19822 ④ · Damond Pendant

Hardware: Chrome / Metal
 Shade: Clear / Crystal
 Lamp: E-27 Medium Base (Max. 100W) ③ x2 ④
 Features: **Crystal Accent, Adjustable Heights, Frosted Diffuser** ④



①

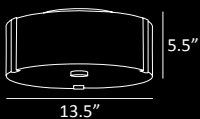

②

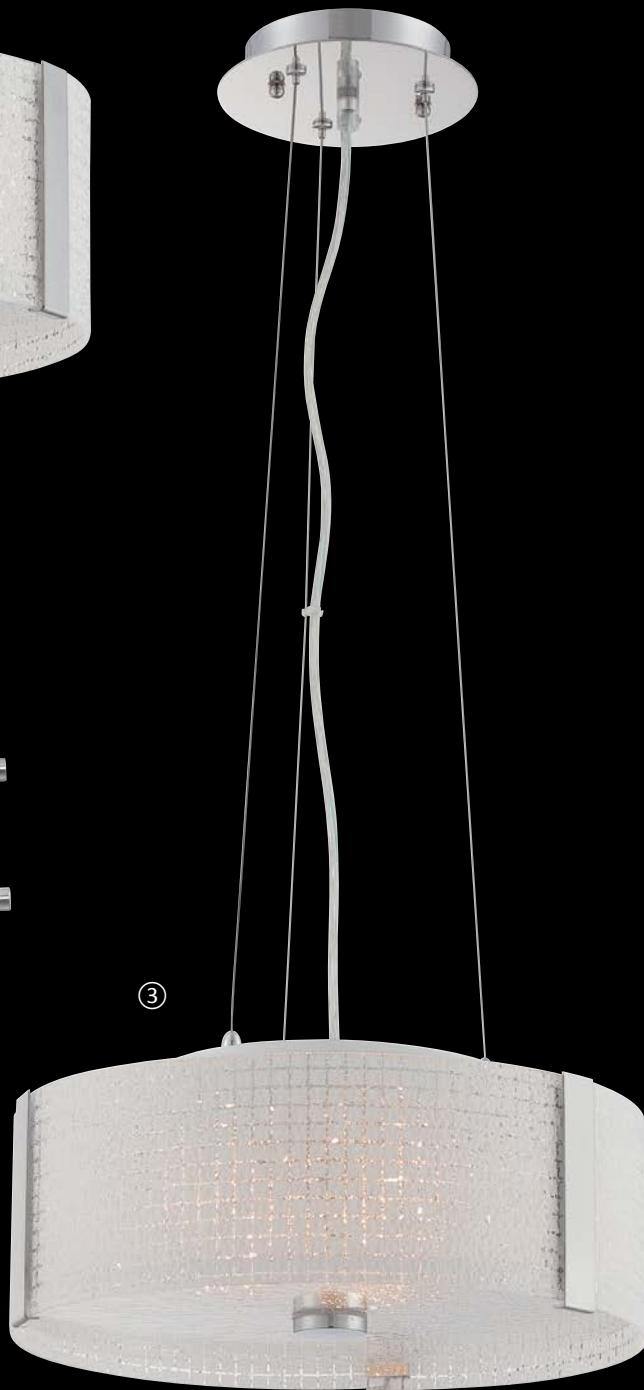
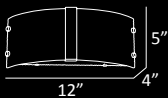

③

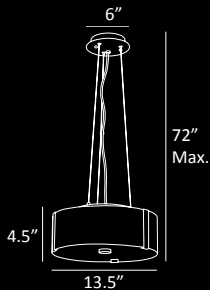

LS-5912 ① · Maso Flush Mount

Hardware: Chrome / Metal
 Shade: Mosaic Quartz / Glass
 Lamp: E-27 Medium Base (Max. 60W) x3
 Features: Quartz Glass, Diffuser

LS-16512 ② · Maso Sconce

Hardware: Chrome / Metal
 Shade: Mosaic Quartz / Glass
 Lamp: E-27 Medium Base (Max. 60W)
 Features: Quartz Glass, Diffuser, ADA

LS-19581 ③ · Maso Pendant

Hardware: Chrome / Metal
 Shade: Mosaic Quartz / Glass
 Lamp: E-27 Medium Base (Max. 60W) x3
 Features: Quartz Glass, Diffuser, Adjustable Height



①

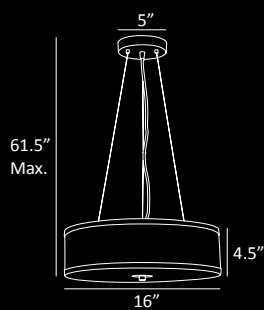
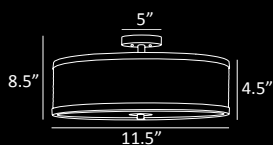

②



LS-5576 ① · Gianetta Semi-Flush Mount

Hardware: Chrome / Metal
 Shade: Individually Twisted / Glass
 Lamp: E-27 Medium Base (Max. 60W) x3
 Features: Individually Twisted Glass Décor, Diffuser

LS-18575 ② · Gianetta Pendant

Hardware: Chrome / Metal
 Shade: Individually Twisted / Glass
 Lamp: E-27 Medium Base (Max. 60W) x4
 Features: Individually Twisted Glass Décor, Diffuser, Adjustable Height

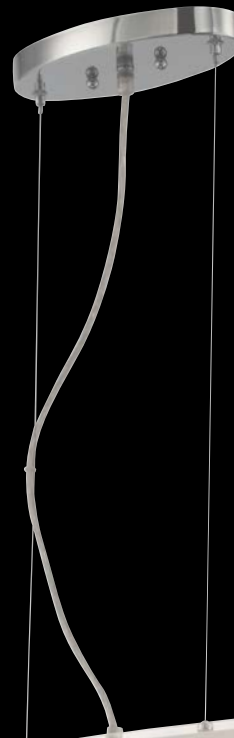
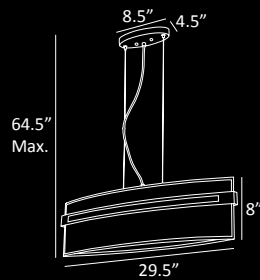
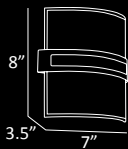
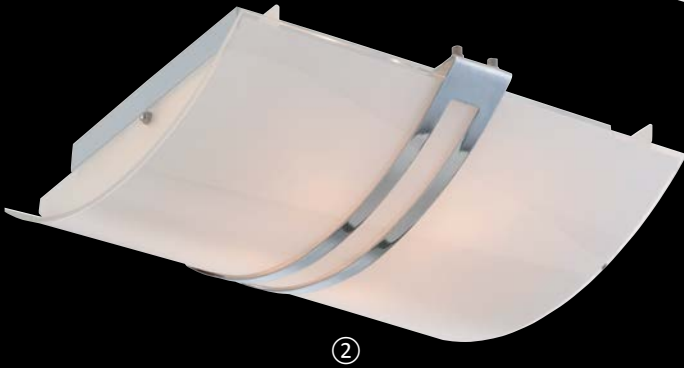
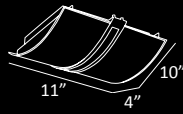
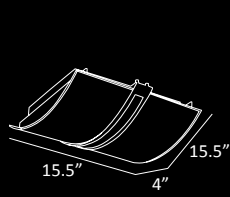
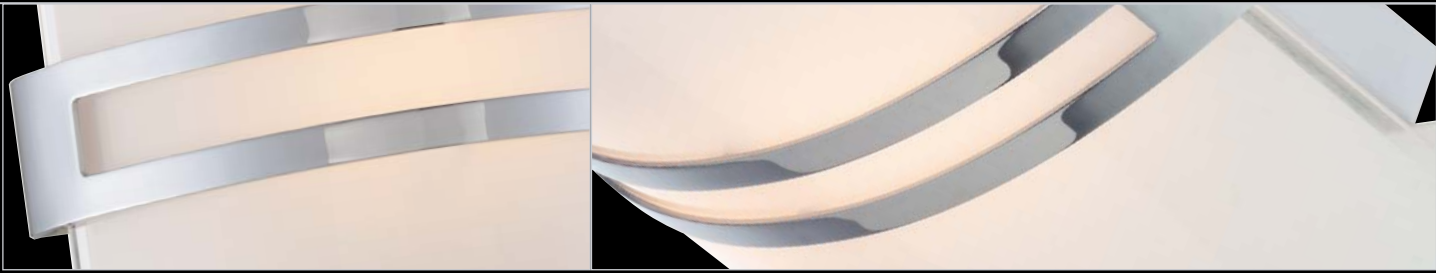

LS-5572 ①
LS-5573 ② · Galena Flush Mount
 Hardware: Chrome / Metal
 Shade: Frosted w. Clear Edge / Glass
 Lamp: E-27 Medium Base
 (Max. 40W) x2 ① x4 ②

LS-16572 ③ · Galena Sconce
 Hardware: Chrome / Metal
 Shade: Frosted w. Clear Edge / Glass
 Lamp: 3W LED (3000K, 240lm, CRI: 80)
 Features: **ADA**

LS-18572 ④ · Galena Pendant
 Hardware: Chrome / Metal
 Shade: Frosted w. Clear Edge / Glass
 Lamp: E-27 Medium Base (Max. 60W) x4
 Features: **Adjustable Heights**

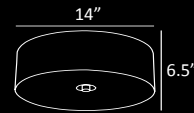

①

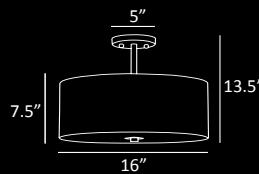

②



③

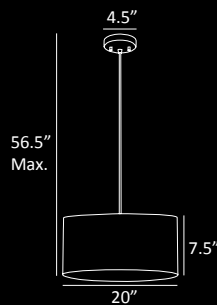

LS-5569C/SIL ① · Silvain Flush Mount

Body: Chrome / Metal

Shade: Silver / Fabric

Lamp: E-27 Medium Base (Max. 60W) x2

Features: **Frosted Diffuser**

LS-5570C/SIL ② · Silvain Semi-Flush Mount

Body: Chrome / Metal

Shade: Silver / Fabric

Lamp: E-27 Medium Base (Max. 60W) x3

Features: **Frosted Diffuser**

LS-18571C/SIL ③ · Silvain Pendant

Body: Chrome / Metal

Shade: Silver / Fabric

Lamp: E-27 Medium Base (Max. 100W) x3

Features: **3-Light, Frosted Diffuser, Adjustable Height**

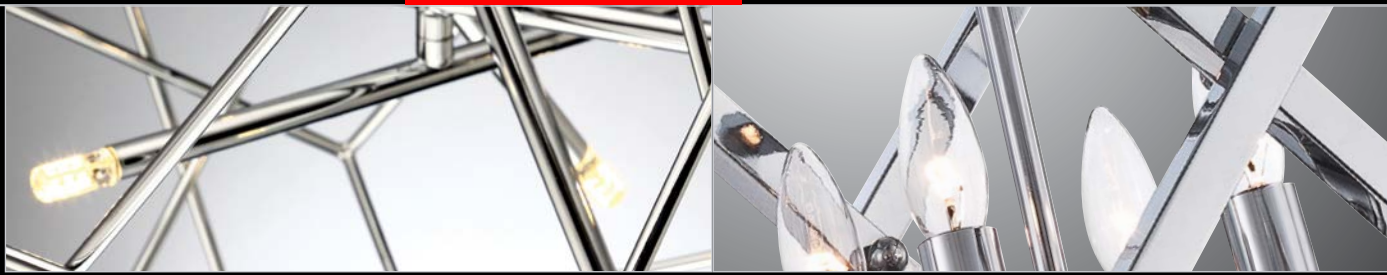

①



②



③

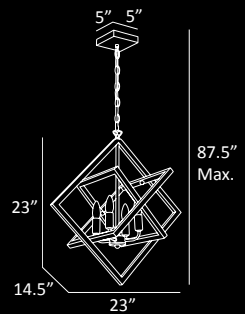
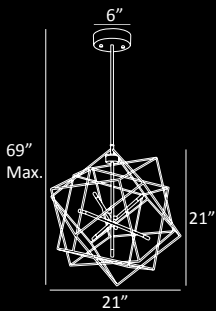

LS-19855 ①

LS-19855C ② · Stacia Pendant

Body: French Gold or Chrome / Metal

Shade: Matching Finish / Metal

Lamp: 3W x7 G4 LED Bulb (3000K, 1260lm, CRI: 80)

Features: **Replaceable LED Bulbs, Adjustable Height**

LS-19889 ③ · Isidro Chandelier

Body: Chrome / Metal

Shade: Chrome / Metal

Lamp: E-12 Candelabra Base (Max. 60W) x4

Features: **Adjustable Chain**

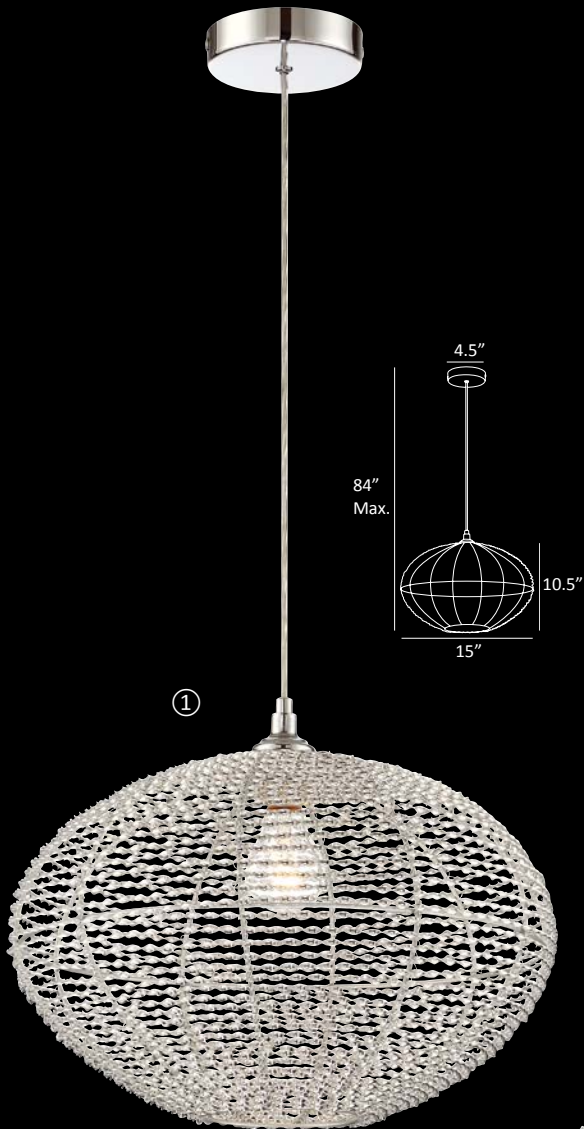

①

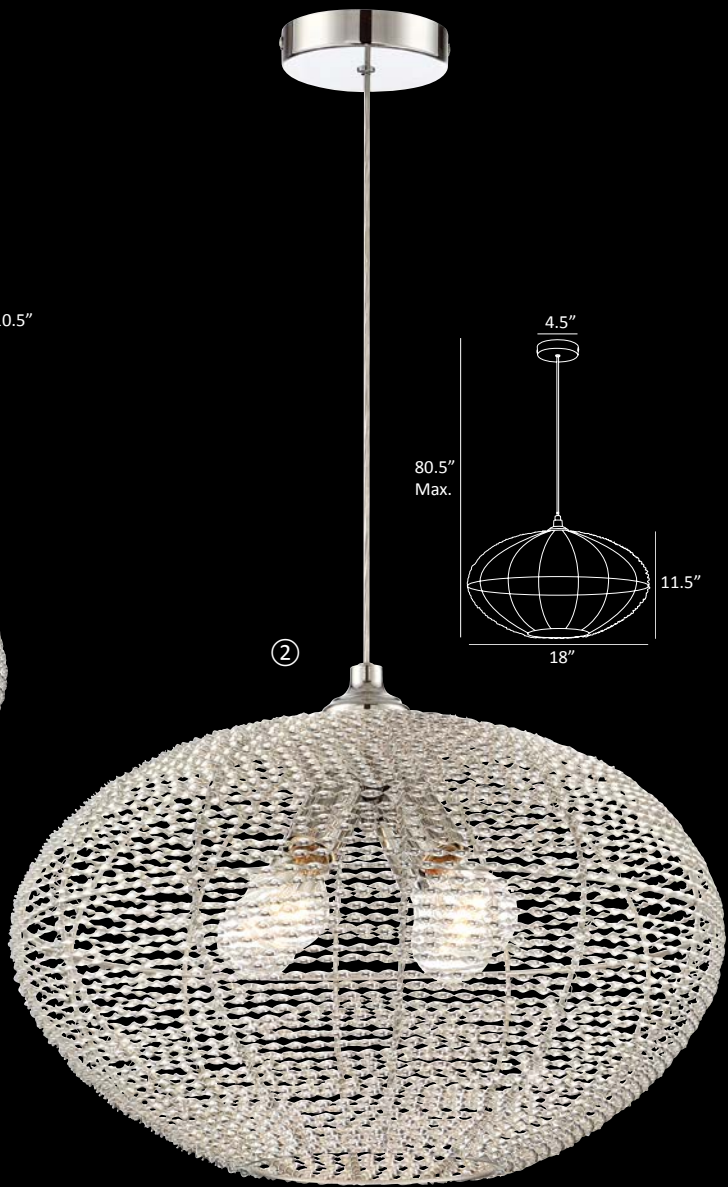

②

LS-18997 ① · Faviola Pendant

Hardware: Chrome / Metal
 Shade: Aluminum Pleated / Metal
 Lamp: E-27 Medium Base (Max. 100W)
 Features: **Adjustable Height**

LS-18998 ② · Faviola Pendant

Hardware: Chrome / Metal
 Shade: Aluminum Pleated / Metal
 Lamp: E-27 Medium Base (Max. 60W) x4
 Features: **Adjustable Height**



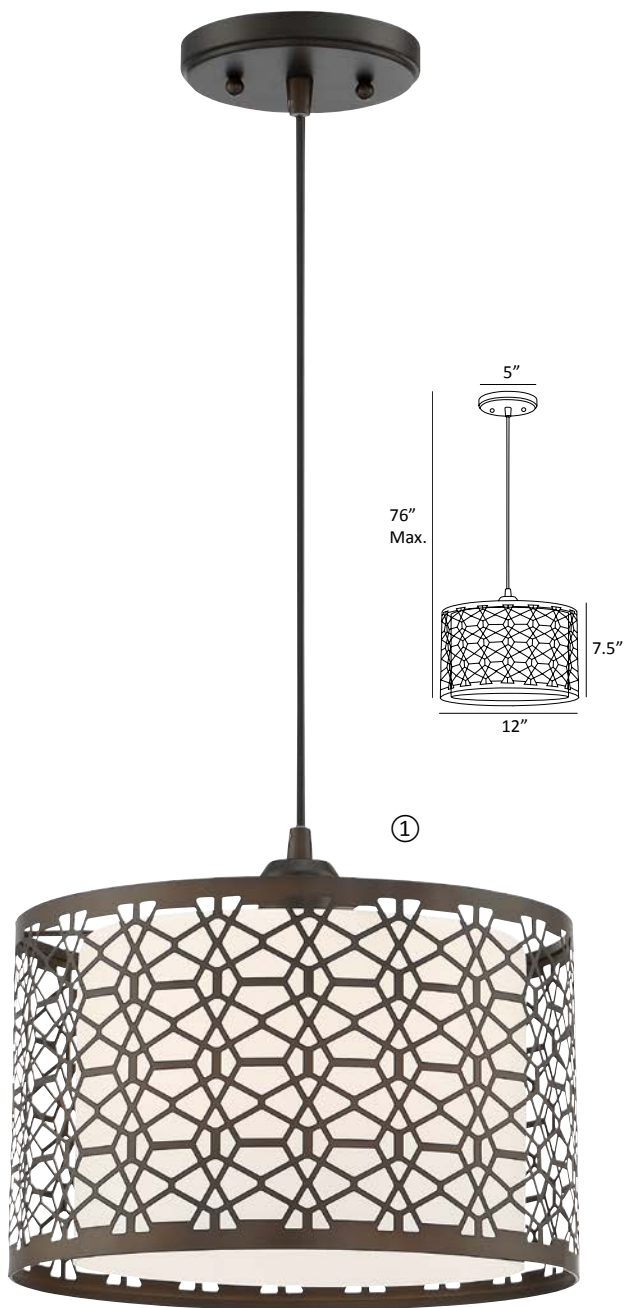

LS-19215 ① · Julia Pendant

Body: Coffee Matte / Metal
 Inner Shade: Frosted / Glass
 Lamp: E-27 Medium Base (Max. 60W)
 Features: **Double-Layer Shade, Adjustable Height**

LS-19216 ② · Jules Pendant

Body: Coffee Matte / Metal
 Inner Shade: Frosted / Glass
 Lamp: E-27 Medium Base (Max. 60W)
 Features: **Double-Layer Shade, Adjustable Height**

**LS-5524 ① · Adalyn Semi-Flush Mount**

Body: Dark Bronze / Metal
 Shade: Off-White / Fabric
 Lamp: E-27 Medium Base (Max. 60W) x2
 Features: **Frosted Diffuser**

LS-16524 ② · Adalyn Sconce

Body: Dark Bronze / Metal
 Shade: Frosted / Glass
 Lamp: JCD/G9 Halogen (Max. 60W)
 Features: **Halogen Bulb Included**

LS-16525 ③ · Adalyn 3-Light Vanity

Body: Dark Bronze / Metal
 Shade: Frosted / Glass
 Lamp: E-27 Medium Base (Max. 60W) x2
 & JCD/G9 Halogen (Max. 60W) x1
 Features: **Halogen Bulbs Included**

LS-19523 ④ · Adalyn Mini-Pendant

Body: Dark Bronze / Metal
 Shade: Frosted / Glass
 Lamp: E-27 Medium Base (Max. 60W)
 Features: **Adjustable Height**

LS-19524 ⑤ · Adalyn Pendant

Body: Dark Bronze / Metal
 Shade: Frosted / Glass
 Lamp: E-27 Medium Base (Max. 60W) x3
 Features: **Frosted Diffuser, Adjustable Height**



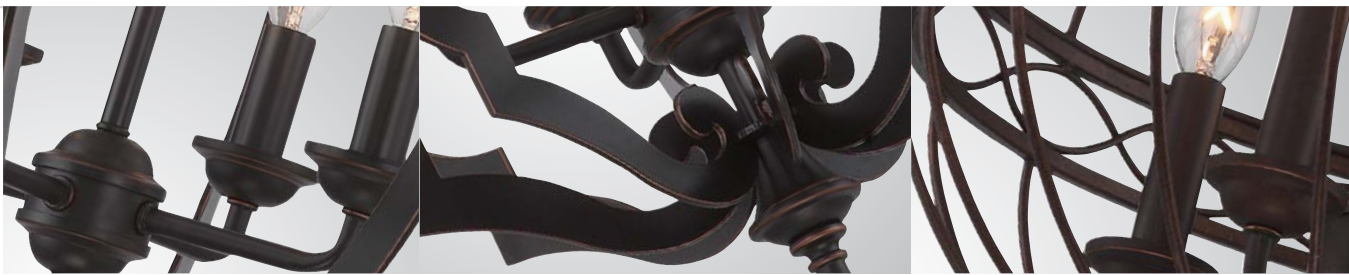

C71357 ① · Oria Chandelier

Body: Dark Bronze / Metal
Lamp: E-12 Candelabra Base (Max. 60W) x4
Lamp Dimension: 23.5”H x 18”Dia.
Chain Length: 60”Max.
Features: **Open Cage Design, Adjustable Height**

C71358 ② · Orlena Chandelier

Body: Dark Bronze / Metal
Lamp: E-12 Candelabra Base (Max. 60W) x4
Lamp Dimension: 24”H x 16”Dia.
Chain Length: 60”Max.
Features: **Open Cage Design, Adjustable Height**

C71359 ③ · Winterlynn Chandelier

Body: Dark Bronze / Metal
Lamp: E-12 Candelabra Base (Max. 60W) x4
Lamp Dimension: 26”H x 16”Dia.
Chain Length: 60”Max.
Features: **Open Cage Design, Adjustable Height**



LS-19616 ① · Farica Chandelier

Body: Chrome / Metal
 Décor: Full-Cut / Crystal
 Lamp: E-12 Candelabra Base (Max. 40W) x6
 Features: **Crystal Droplets**

LS-19727 ② · Farrah Chandelier

Body: Rusted Bronze / Metal
 Lamp: E-12 Candelabra Base (Max. 60W) x5
 Features: **Open Cage Design, Adjustable Height**

LS-19152 ③ · Manton Chandelier

Body: Black / Metal
 Lamp: E-27 Medium Base (Max. 40W) x4
 Features: **Open Cage Design, Adjustable Height, Vintage Edison Bulbs Included**

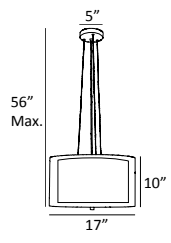
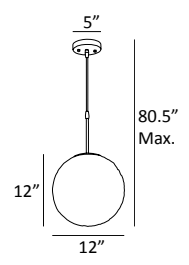
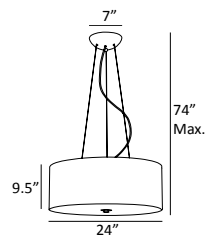
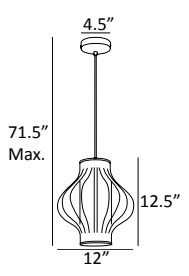
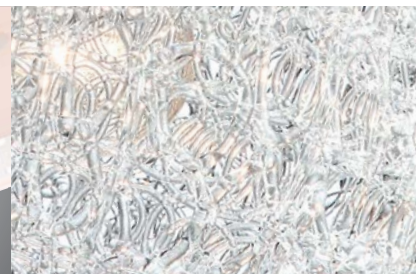
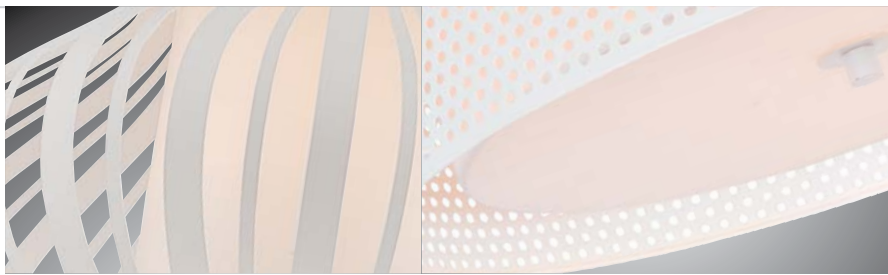

LS-18770WHT ① · Lanica Pendant

Hardware: Chrome / Metal
 Shade: White Vinyl / Frosted Vinyl
 Lamp: E-27 Medium Base (Max. 40W)
 Features: **Double-Layer Shade, Adjustable Height**

LS-19149 ③ · Olwen II Pendant

Hardware: Chrome / Metal
 Shade: White / Paper
 Lamp: E-27 Medium Base (Max. 100W) x3
 Features: **Frosted Diffuser, Adjustable Height**

LS-18959 ② · Parmida Pendant

Hardware: White / Metal
 Shade: White Metal / White Fabric
 Lamp: E-27 Medium Base (Max. 100W) x2
 Features: **Double-Layer Shade, Adjustable Height**

LS-19598 ④ · Icy Pendant

Hardware: Brushed Nickel / Metal
 Shade: Clear / Acrylic
 Lamp: E-27 Medium Base (Max. 60W)
 Features: **Acrylic Wire Wrapped Shade, Adjustable Height**

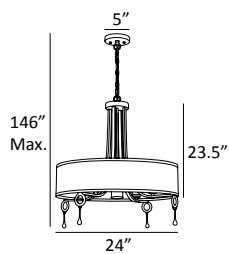
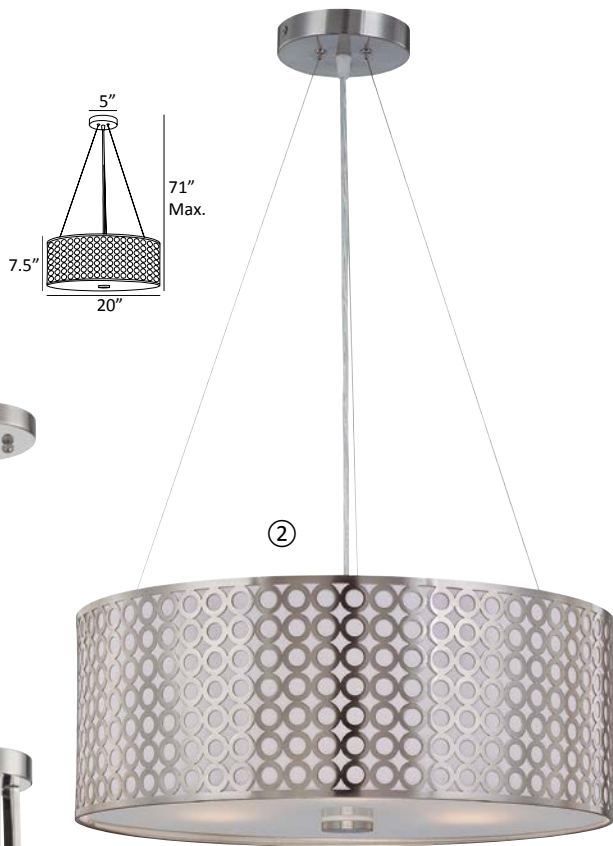
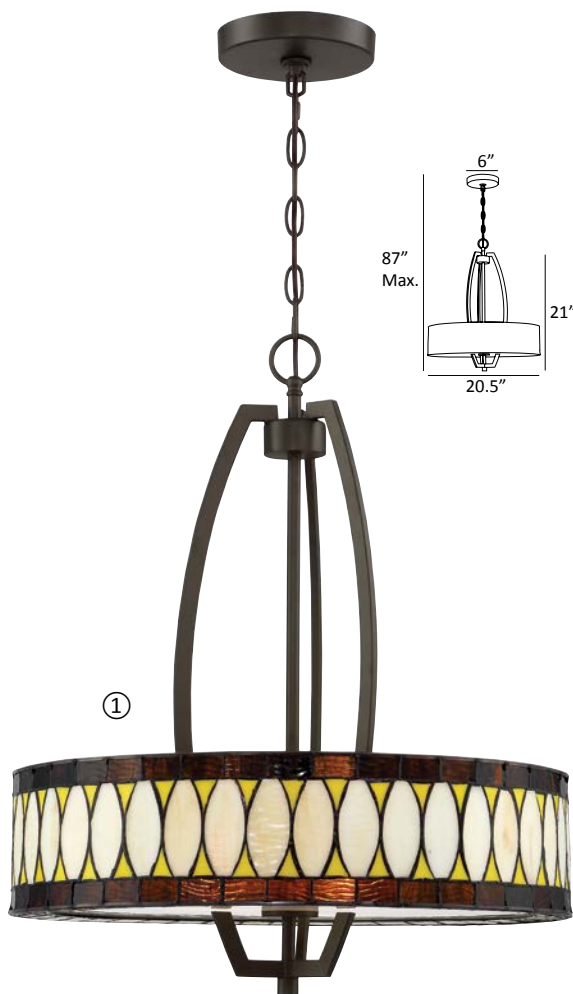
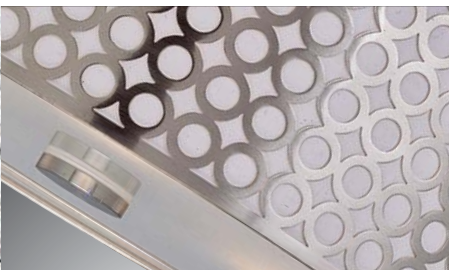

C71390 ① · Geoffrey Pendant

Body: Dark Bronze / Metal
 Shade: Tiffany / Glass
 Lamp: E-27 Medium Base (Max. 60W) x3
 Features: **Tiffany Shade, Frosted Diffuser, Adjustable Height**

LS-19519PS ② · Netto Pendant

Body: Polished Steel / Metal
 Shade: Laser-Cut Metal / Frosted Vinyl
 Lamp: E-27 Medium Base (Max. 60W) x3
 Features: **Double-Layer Shade, Frosted Diffuser, Adjustable Height**

LS-19733 ③ · MacBeth Chandelier

Hardware: Brushed Nickel / Metal
 Shade: Clear / Organza
 Main Lamp: E-27 Medium Base (Max. 40W) x4
 Center Spotlight: GU10 Halogen (Max. 35W)
 Features: **Crystal Droplet, Adjustable Height, Vintage Edison Bulb & Halogen Bulb Included**

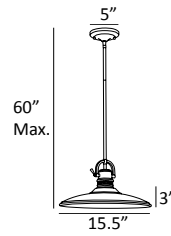
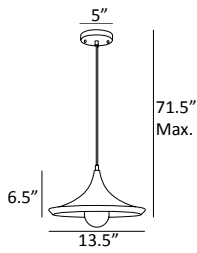
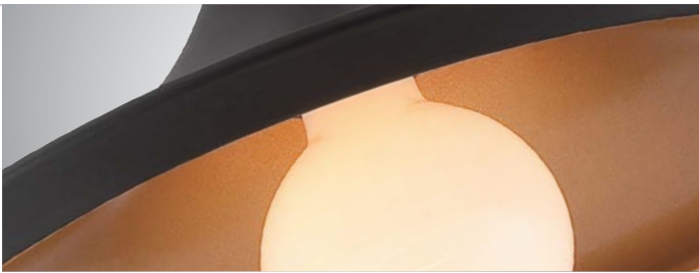

LS-19602BLK ①

LS-19602SILV ② · Landis Pendant

Hardware: Black or Silver / Metal
 Shade: Black or Silver Metal / Copper Liner
 Lamp: E-27 Medium Base (Max. 60W)
 Features: **G95 Type Bulb Included, Adjustable Height**

LS-19927 ③ · Whistler Pendant

Hardware: Aged Copper / Metal
 Shade: Aged Copper / Metal
 Lamp: E-27 Medium Base (Max. 100W)
 Features: **Adjustable Shade, Adjustable Height**

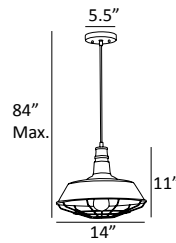
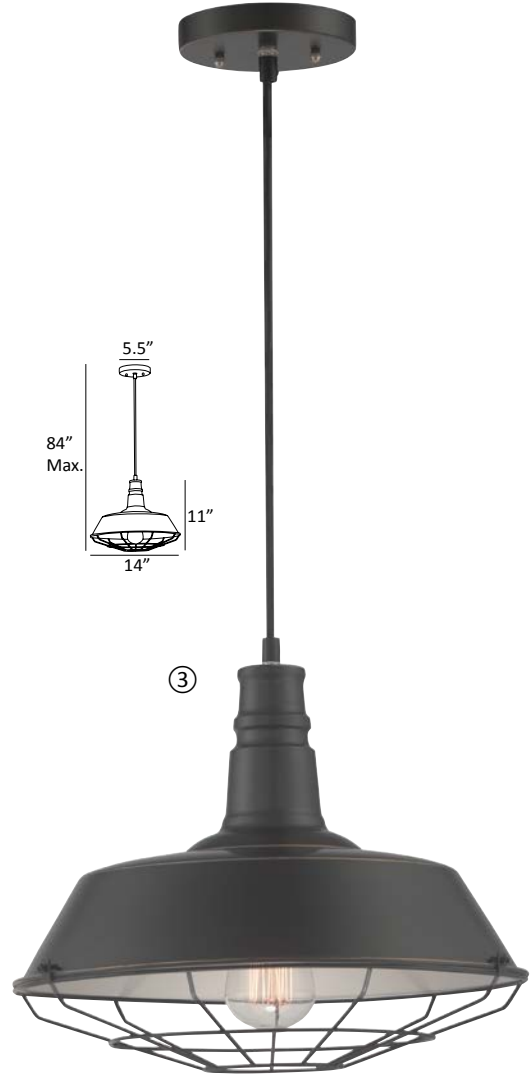
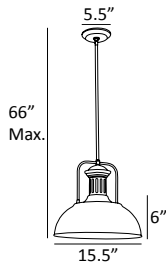
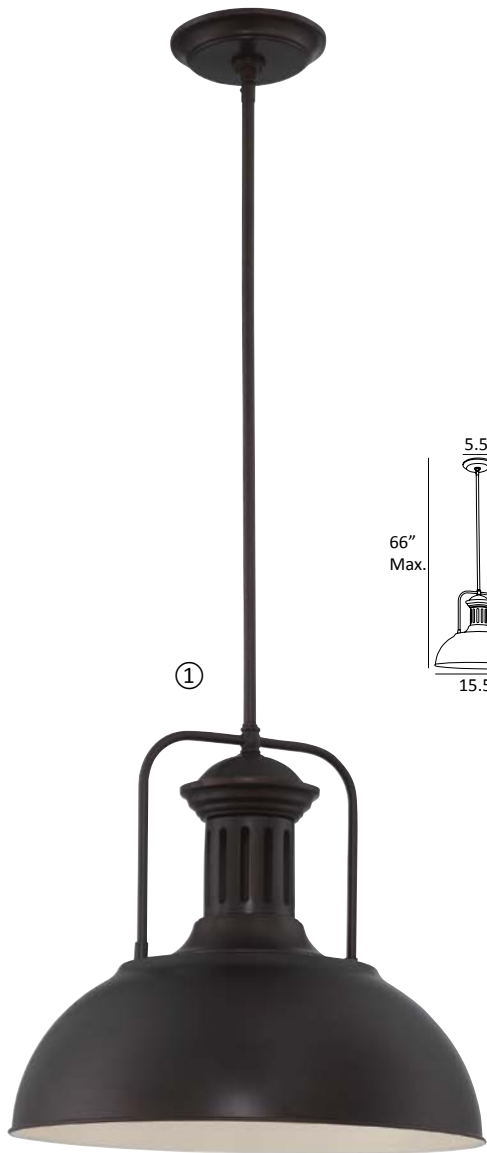
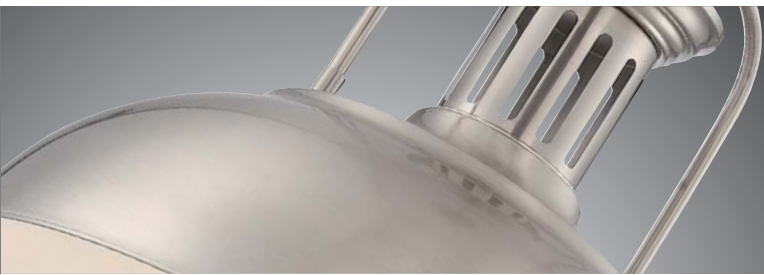

LS-19922D/BRZ ①

LS-19922PS ② · Efren Pendant

Hardware: Dark Bronze or Polished Steel / Metal
Shade: Dark Bronze or Polished Steel / Metal
Lamp: E-27 Medium Base (Max. 100W)
Features: **Adjustable Height**

LS-19049 ③ · Calvin Pendant

Hardware: Dark Bronze / Metal
Shade: Dark Bronze / Metal
Lamp: E-27 Medium Base (Max. 75W)
Features: **Vintage Edison Bulb Included, Adjustable Height**

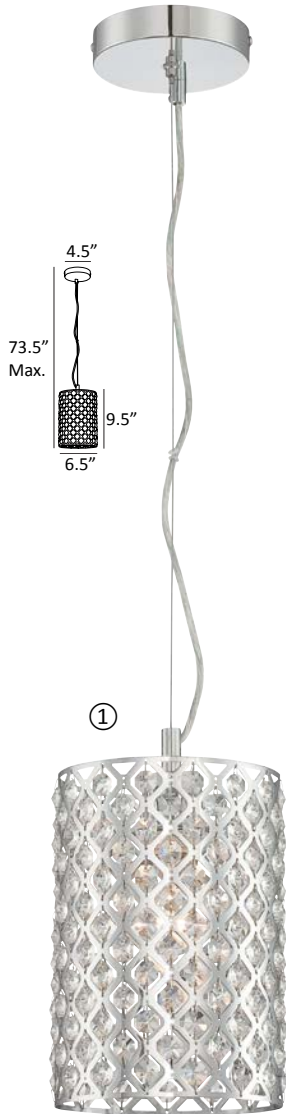

①



②

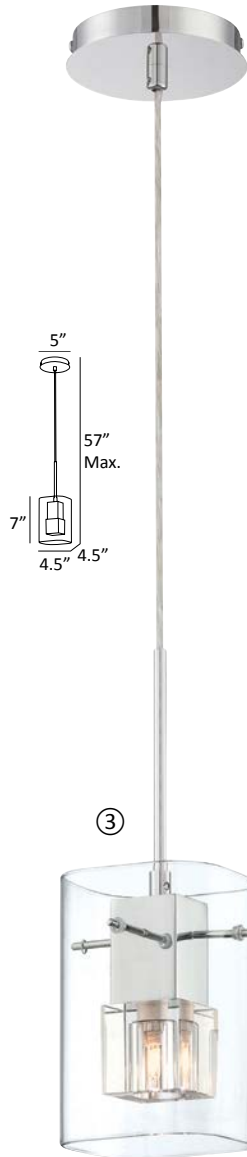

③

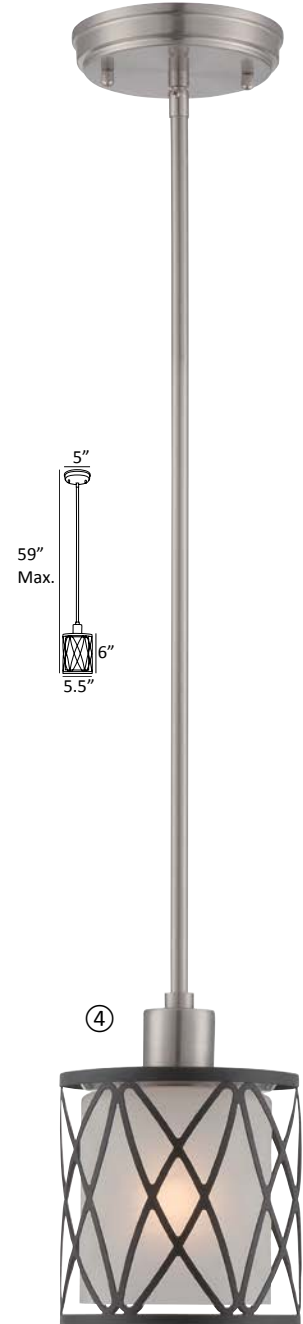

④

LS-18641C ① · Tosca Mini-Pendant

Hardware: Chrome / Metal
Shade: Chrome Metal / Crystal
Lamp: E-27 Medium Base (Max. 60W)
Features: **Crystal Accent, Adjustable Height**

LS-19586 ③ · Aida Mini-Pendant

Hardware: Chrome / Metal
Shade: Clear Glass / Clear Crystal
Lamp: JCD/G9 Halogen (Max. 40W)
Features: **Halogen Bulb Included, Double-Layer Shade, Adjustable Height**

LS-19213 ② · Reaves Pendant

Hardware: Black / Metal
Shade: Rattan / Off-White Fabric
Lamp: E-27 Medium Base (Max. 60W)
Features: **Double-Layer Shade, Adjustable Height**

LS-19808 ④ · Quillon Mini-Pendant

Hardware: Brushed Nickel / Metal
Shade: Black Metal / Frosted Glass
Lamp: E-27 Medium Base (Max. 60W)
Features: **Double-Layer Shade, Adjustable Height**

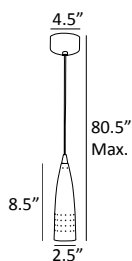

①

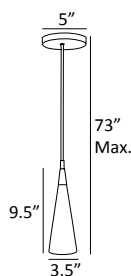
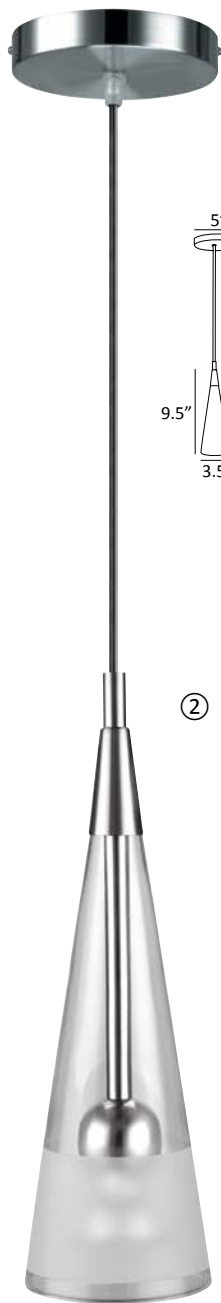

②

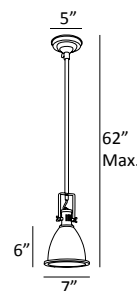

③



④

LS-1425PS ① · Moda Mini-Pendant

Hardware: Polished Steel / Metal
Shade: Polished Steel / Metal
Lamp: MR16 Halogen (Max. 35W)
Features: **Halogen Bulb Included, Adjustable Height**

LS-17971PS/CLR ② · Conic Pendant

Hardware: Polished Steel / Metal
Shade: Clear & Frosted / Glass
Lamp: GU10 Halogen (Max. 50W)
Features: **Halogen Bulb Included, Adjustable Height**

LS-19976C ③

LS-19976D/BRZ ④ · Kartik Mini-Pendant
Hardware: Chrome or Dark Bronze / Metal
Shade: Chrome or Dark Bronze / Metal
Lamp: E-27 Medium Base (Max. 60W)
Features: **Adjustable Shade, Adjustable Height**





LS-19105SMOKE ① · Zelia Mini-Pendant

Hardware: Chrome / Metal
 Shade: Smoke Mirror / Glass
 Lamp: E-27 Medium Base (Max. 40W)
 Features: **Vintage Edison T30 Type Bulb Included, Adjustable Height**

LS-19830AB ②

LS-19830AGED/CP ③ · Umar Mini-Pendant

Hardware: Black / Metal
 Shade: Antique Brass or Aged Copper / Metal
 Lamp: E-27 Medium Base (Max. 60W)
 Features: **Vintage Edison G Type Bulb Included, Adjustable Height**

LS-19888 ④ · Bubba Pendant

Hardware: Chrome / Metal
 Shade: Clear / Glass
 Lamp: E-27 Medium Base (Max. 60W)
 Features: **Adjustable Height**

LS-19937 ⑤ · Ferguson Pendant

Hardware: Wrought Iron / Metal
 Shade: Wrought Iron / Metal
 Lamp: E-27 Medium Base (Max. 75W)
 Features: **Vintage Edison Bulb Included, Adjustable Height**

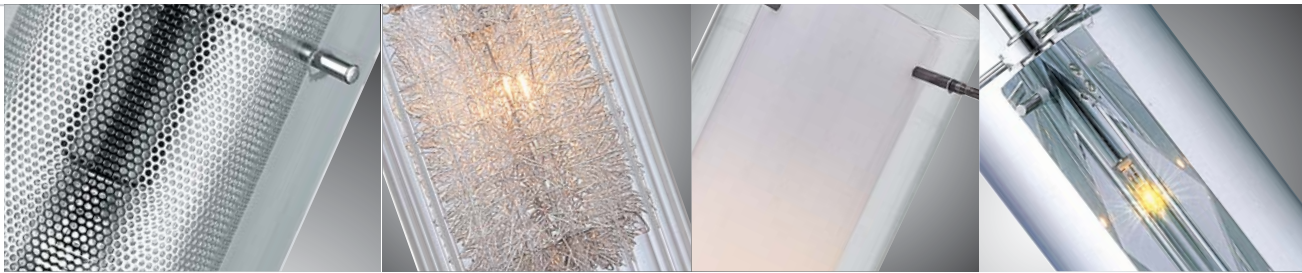

LS-17851PS/CLR ① · Wick Mini-Pendant

Hardware: Polished Steel / Metal
 Shade: Clear Glass / Chrome Mesh Metal
 Lamp: E-12 Candelabra Base (Max. 25W)
 Features: **Double-Layer Shade, Adjustable Height**

LS-19772 ③ · Jaden Mini-Pendant

Hardware: Black / Metal
 Shade: Clear Glass / Frosted Glass
 Lamp: E-27 Medium Base (Max. 60W)
 Features: **Double-Layer Shade, Adjustable Height**

LS-19377 ② · Caldwell Mini-Pendant

Hardware: Chrome / Metal
 Shade: Clear Glass / Aluminum Wire
 Lamp: E-12 Candelabra Base (Max. 40W)
 Features: **Double-Layer Shade, Adjustable Height**

LS-19959C/CLR ④ · Clarte Mini-Pendant

Hardware: Chrome / Metal
 Shade: Clear Glass / Clear Crystal
 Lamp: JC/G4 Halogen (Max. 20W)
 Features: **Halogen Bulb Included, Crystal Double-Layer Shade, Adjustable Height**

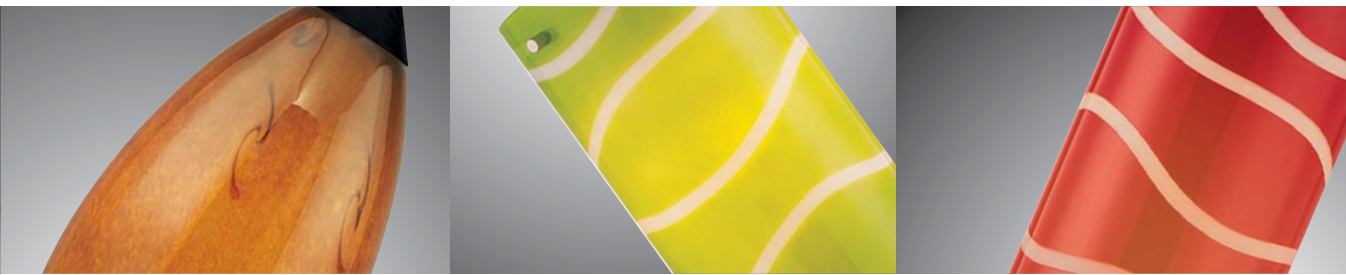

CREDENCE
STRANO
PACIFICA



LS-19112PS/FRO ①
 · Credence Mini-Pendant
 Hardware: Polished Steel / Metal
 Shade: Frosted / Glass
 Lamp: E-12 Candelabra Base (Max. 40W)
 Features: **Adjustable Height**

LS-19982 ② · Strano Mini-Pendant
 Hardware: Dark Bronze / Metal
 Shade: Amber Art / Glass
 Lamp: E-27 Medium Base (Max. 60W)
 Features: **Adjustable Height**

LS-19991BLU ③
LS-19991GRN ④
LS-19991RED ⑤
LS-19991WHT ⑥ · Pacifica Mini-Pendant
 Hardware: Brushed Nickel / Metal
 Shade: Blue, Green, Red or White / Glass
 Lamp: E-27 Medium Base (Max. 60W)
 Features: **Adjustable Height**

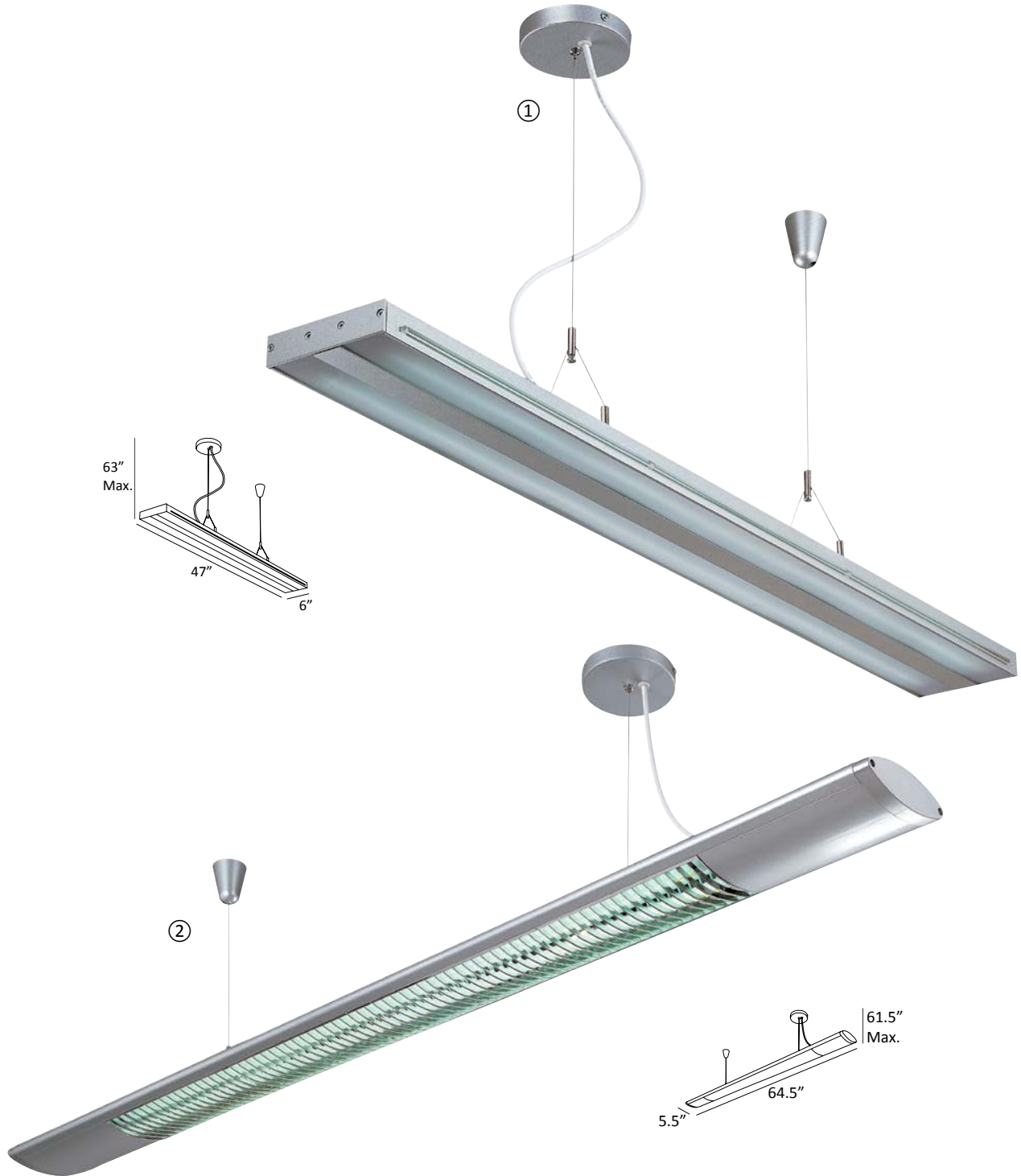

LS-19689SILV ① · Giada Shop Light

Hardware: Silver / Metal
 Shade: Aluminum Metal / Frosted Arcylic
 Lamp:T5/G5 Fluorescent Bulb (Max. 28W) x2
 Features: **Bulbs Included (6400K), Adjustable Height**

LS-19692SILV ② · Bellini Shop Light

Hardware: Silver / Metal
 Shade: Aluminum Metal / Clear Arcylic
 Lamp:T5/G5 Fluorescent Bulb (Max. 28W) x2
 Features: **Bulbs Included (6400K), Adjustable Height**

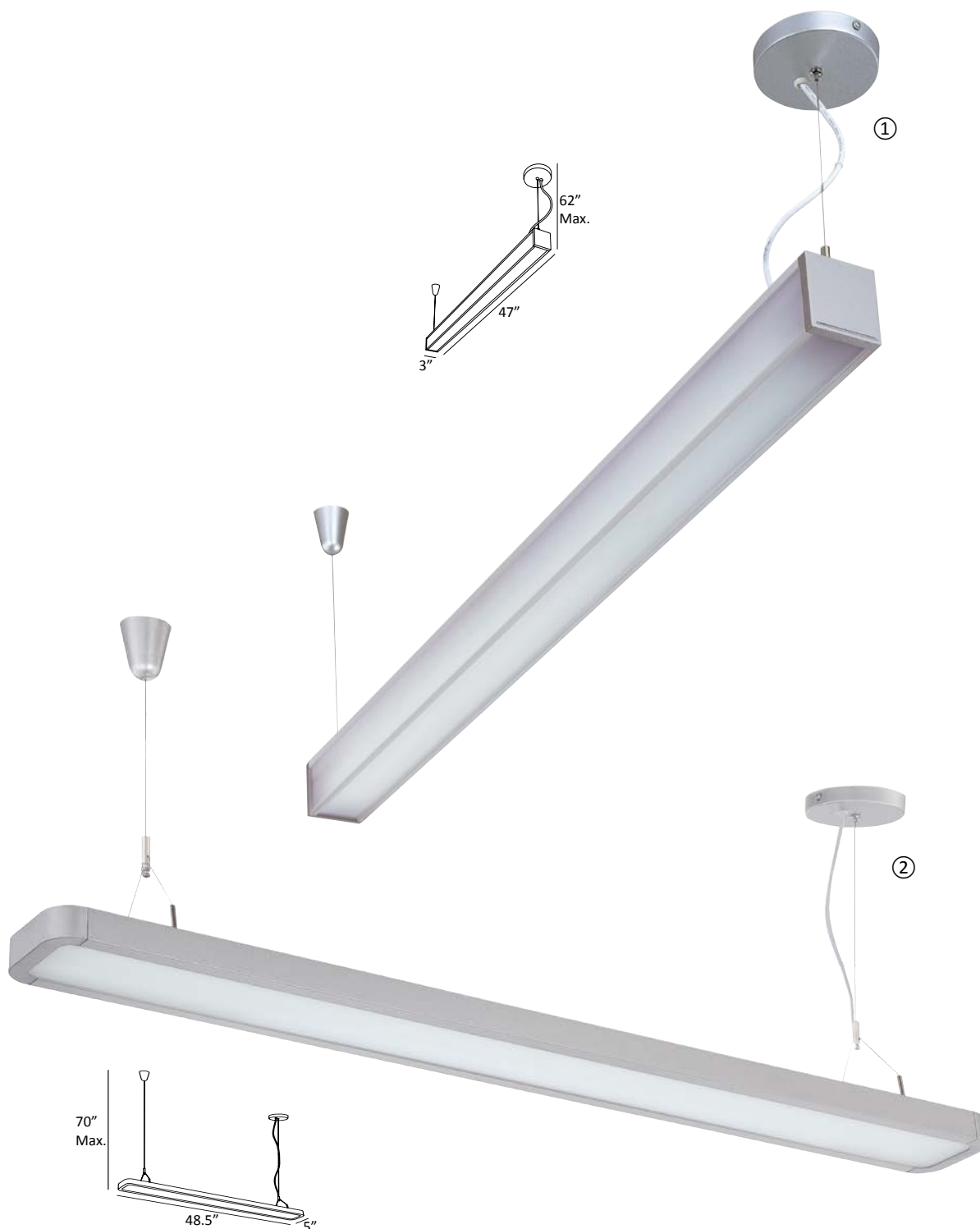
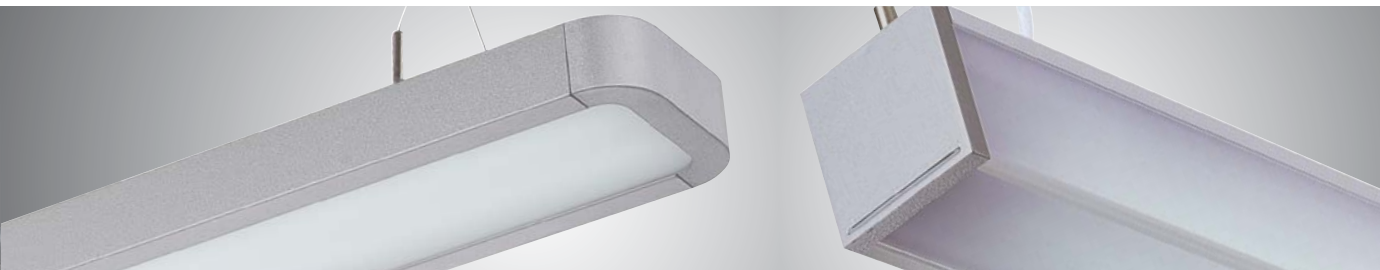

LS-19682WHT ① · Lidia Shop Light
 Hardware: Silver / Metal
 Shade: Aluminum Metal / Frosted Acrylic
 Lamp: T5/G5 Fluorescent Bulb (Max. 28W) x2
 Features: **Bulbs Included (6400K), Adjustable Height**

LS-19798SILV ② · Raylyn Shop Light
 Hardware: Silver / Metal
 Shade: Aluminum Metal / Frosted Acrylic
 Lamp: 28.8W LED Panel (6000K, 3200lm, CRI: 80)
 Features: **LED Panel Included, Adjustable Height**





LS-16146BLK/AB ① / LS- 16146BN ② / LS- 16146D/BRZ ③ · Norco Wall Lamp

Body: Black & Antique Brass, Brushed Nickel or Dark Bronze / Metal

Shade: Matching Finish / Metal

Switch: On/Off Rotary on Canopy

Lamp: E-27 Medium Base (Max. 60W)

Features: **Swing-Arm, Adjustable Arms & Shade, Switch on Canopy**

K A S E N
P R I S C A
S E R A F I N O
J A Y L E E
H A R V A R D
C O L U M B O

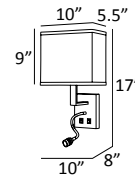
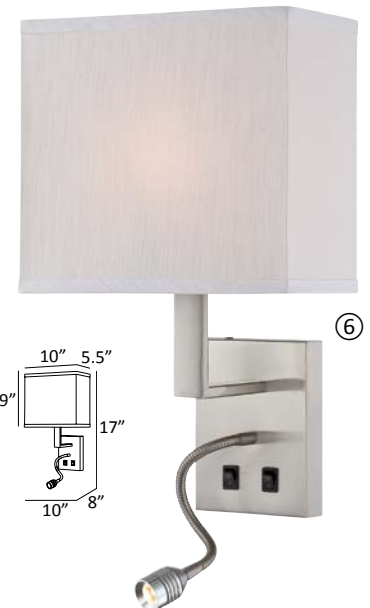
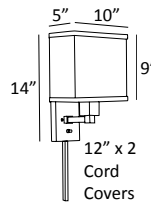
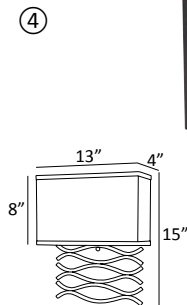
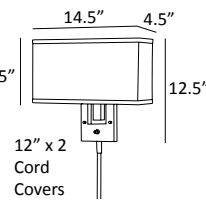
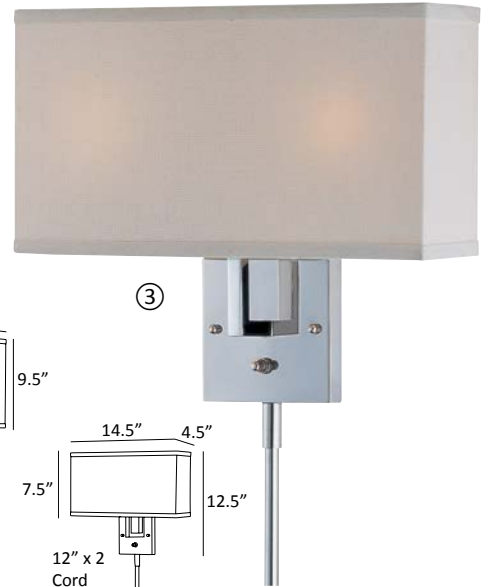
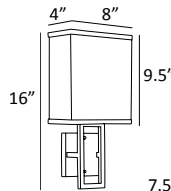
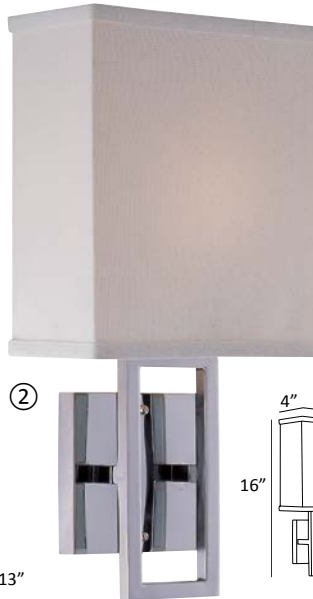
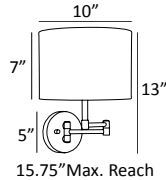

LS-16515WHT ① · Kasen Wall Lamp

Body: Polished Steel / Metal
Shade: Off-White / Fabric
Switch: On/Off Socket
Lamp: E-27 Medium Base (Max. 60W)
Features: **Swing-Arm, Socket Switch**

LS-16585C/WHT ② · Prisca Wall Lamp

Body: Chrome / Metal
Shade: Off-White / Fabric
Lamp: E-12 Candelabra Base (Max. 60W)
Features: **ADA**

LS-16586C/WHT ③ · Serafino Wall Lamp

Body: Chrome / Metal
Shade: Off-White / Fabric
Switch: On/Off Rotary on Canopy
Lamp: E-12 Candelabra Base (Max. 40W) x2
Features: **Switch on Canopy, Cord Cover Included**

LS-16917 ④ · Jaylee Wall Lamp

Body: Dark Bronze / Metal
Shade: Off-White / Fabric
Lamp: GU24 Base (Max. 60W)
Features: **ADA**

LS-16919 ⑤ · Harvard Wall Lamp

Body: Dark Bronze / Metal
Shade: Beige w. Black Trim / Fabric
Switch: On/Off Rotary on Canopy
Lamp: E-27 Medium Base (Max. 60W)
Features: **Switch on Canopy, Cord Cover Included**

LS-16979 ⑥ · Columbo Wall Lamp/Reading Lamp

Body: Brushed Nickel / Metal
Shade: White / Fabric
Switch: Dual On/Off Rocker on Canopy
Mail Lamp: E-27 Medium Base (Max. 60W)
Reading Lamp: 1W LED (3000K, 100lm, CRI: 80)
Features: **Dual Switch on Canopy, Gooseneck (Reading Lamp)**



LS-16328 ① · Liko Wall Lmap
 Body: Matte Black & Chrome / Metal
 Shade: Matte Black Metal / Frosted Acrylic
 Switch: Touch Dimmer on Canopy
 Lamp: 6W LED (3000K, 600lm, CRI: 80)
 Features: **Swing-Arm, Adjustable Shade**

LS-16350AB ②
LS-16350PS ③ · Rhine Wall Lamp
 Body: Antique Brass or Polished Steel / Metal
 Shade: Matching Finish / Metal
 Switch: Dimmer Rotary on Canopy
 Lamp: JC/G6.35 Halogen (Max. 35W)
 Features: **Swing-Arm, Adjustable Shade, Dimmer Switch, Plug-in Wire Included**

LS-16753AB ④
LS-16753AGED/CP ⑤
LS-16753PS ⑥ · Rizzo Wall Lamp
 Body: Antique Brass, Aged Copper or Polished Steel / Metal
 Shade: Matching Finish / Metal
 Lamp: E-27 Medium Base (Max. 40W)
 Features: **Swing-Arm, Adjustable Shade, Metal Cord Cover Included, Plug-in Wire Included**

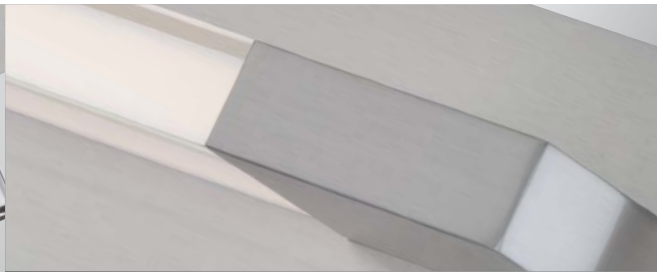

①

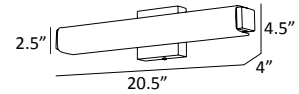
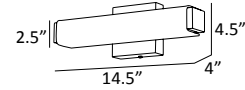

②



③

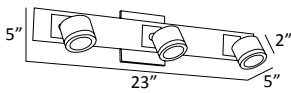

④

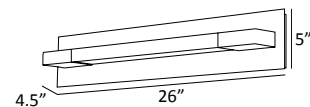

LS-16706 ①

LS-16707 ② · Braulio Sconce

Hardware: Chrome / Metal
Shade: Frosted / Glass
Lamp: 6W ① / 6Wx3 ② LED
(3000K, 1000lm ① / 1500lm ②, CRI: 80)
Features: **ADA, Replaceable & Dimmable LED**

LS-16727 ③ · Michi Sconce/Vanity

Hardware: Chrome / Metal
Shade: Satin Nickel Metal / Frosted Glass Diffuser
Lamp: 5W x3 LED (3000K, 1200lm, CRI: 80)
Features: **Replaceable LED, Adjustable Shades**

LS-16767 ④ · Belina Sconce/Vanity

Hardware: Brushed Nickel / Metal
Shade: Clear Glass / Frosted Diffuser
Lamp: 14W LED (3000K, 852lm, CRI: 80)
Features: **Replaceable & Dimmable LED**



K Y R A
E D R I N N
F L Y N N
P A O L A



①

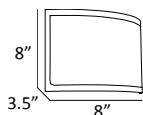

②

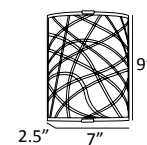

③

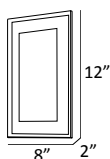
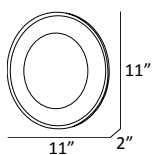

④



⑤

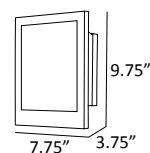

LS-16210C ① · Kyra Sconce

Hardware: Chrome / Metal
Shade: Laser-Cut Metal / Lurex Liner
Lamp: E-12 Candelabra Base (Max. 40W)
Features: **Laser-Cut Metal, ADA**

LS-16788 ② · Edric Sconce

Hardware: Chrome / Metal
Shade: Laser-Cut Metal / Frosted Glass
Mail Lamp: E-27 Medium Base (Max. 60W)
Features: **Laser-Cut Metal, ADA**

LS-16936 ③ / **LS-16937** ④ · Flynn Sconce

Hardware: Brushed Nickel / Metal
Shade: Frosted w. Clear Edge / Glass
Lamp: 6.3W LED (3000K, 480lm, CRI: 80)
Features: **ADA**

LS-16949 ⑤ · Paola Sconce

Hardware: Chrome / Metal
Shade: Frosted Glass / Aluminum Wire Accent
Lamp: E-12 Candelabra Base (Max. 60W) Features:
ADA

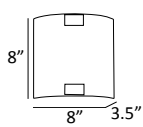
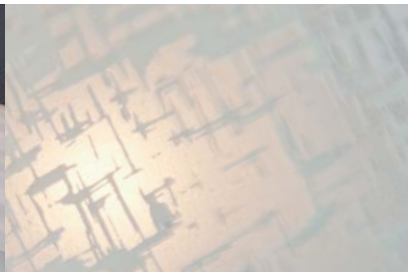
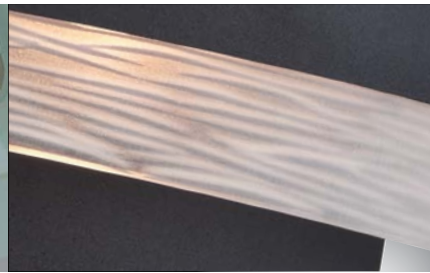

①

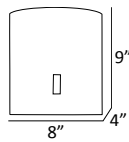

②

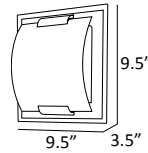

③

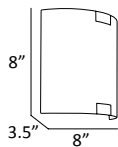

⑤

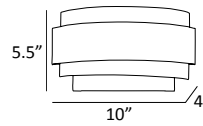

④



LS-1395CLOUD ① · Nimbus Sconce

Hardware: Brushed Nickel / Metal
 Shade: Cloud / Glass
 Lamp: E-12 Candelabra Base (Max. 40W)
 Features: ADA

LS-1693PS/FRO ② · Nimbus II Sconce

Hardware: Brushed Nickel / Metal
 Shade: Frosted Woven-Pattern / Glass
 Lamp: E-12 Candelabra Base (Max. 60W)
 Features: ADA

LS-16105 ③ · Delano Sconce

Back Plate: Satin Nickel Metal / Frosted Glass w. Mirror Edge
 Shade: Frosted w. Clear Edge / Glass
 Lamp: E-12 Candelabra Base (Max. 40W) x2
 Features: ADA, 2-Light

LS-16836 ④ · Gaetano Sconce

Hardware: Black / Metal
 Shade: Black Metal / Cloud Glass Diffuser
 Lamp: JC/G9 Halogen (Max. 40W) x2
 Features: ADA, 2-Light, Halogen Bulbs Included

LS-16838 ⑤ · Sancho Sconce

Hardware: Brushed Nickel / Metal
 Shade: Frosted w. Pattern / Glass
 Lamp: E-12 Candelabra Base (Max. 40W) Features:
 ADA



SHELLEY
SHCALE
ROSINA
KAYSON



①

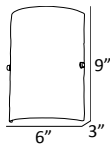

②

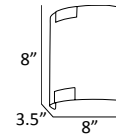

③

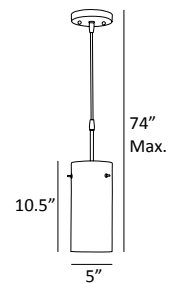

④

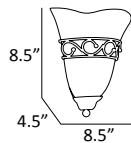

⑤

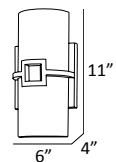

LS-16112 ① · Shelley Sconce

Hardware: Brushed Nickel / Metal
Shade: Capiz Shell / PS
Lamp: E-12 Candelabra Base (Max. 40W)
Features: **Capiz Shell, ADA**

LS-16381 ② · Schale Sconce

Hardware: Brushed Nickel / Metal
Shade: Mosaic / Shell
Lamp: E-12 Candelabra Base (Max. 40W)
Features: **ADA**

LS-19381 ③ · Schale Mini-Pendant

Hardware: Brushed Nickel / Metal
Shade: Mosaic / Shell
Lamp: E-27 Medium Base (Max. 60W)
Features: **Adjustable Height**

LS-16885 ④ · Rosina Sconce

Hardware: Dark Bronze / Metal
Shade: Amber Scavo / Glass
Lamp: E-12 Candelabra Base (Max. 60W)

LS-16977 ⑤ · Kayson Sconce

Hardware: Antique Bronze / Metal
Shade: Frosted / Glass
Lamp: E-12 Candelabra Base (Max. 60W) Features:
ADA

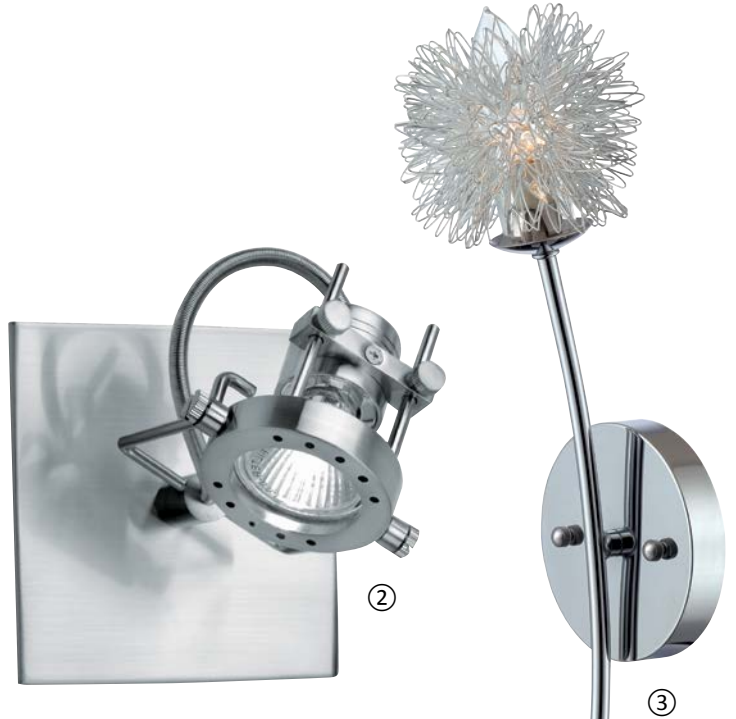
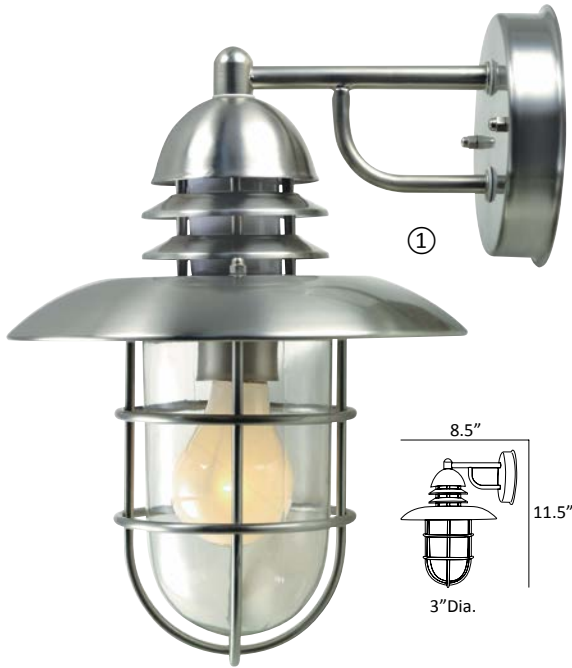

LS-1468STS ① · Lamppost Outdoor Wall Lamp

Body: Stainless Steel / Metal
Shade: Clear / Glass
Lamp: E-27 Medium Base (Max. 60W)
Features: **Outdoor Fixture**

LS-13371PS ② · Technic Spotlight

Hardware: Polished Steel / Metal
Shade: Polished Steel / Metal
Lamp: GU10 Halogen (Max. 35W)
Features: **Bulb Included, Adjustable Shade**

LS-16446 ③ · Hallan Sconce

Body: Stainless Steel / Metal
Shade: Aluminum Wire / Frosted Glass
Lamp: JCD/G9 Halogen (Max. 25W)
Features: **Bulb Included**

LS-16681C ④ · Dekel Sconce

Body: Chrome / Metal
Shade: Frosted / Acrylic Diffuser
Lamp: 6.5W LED (3000K, 288lm, CRI: 80)

LS-16803ALU ⑤ · Saskia Wall Lamp

Body: Aluminum / Metal
Shade: Aluminum / Clear Glass Diffuser
Switch: On/Off Toggle on Canopy
Lamp: 3W LED (3500K, 150lm, CRI: 80)
Features: **Gooseneck**

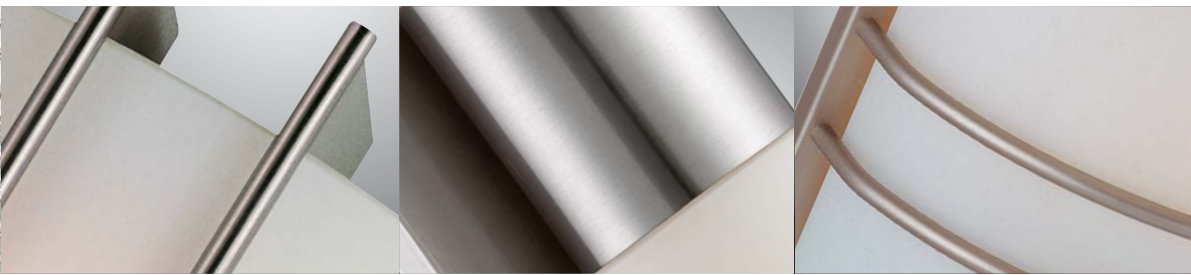

CHECKS
WINDSOR
KAYLA
STROKES
GYALA
CAIRBRE

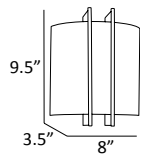

①

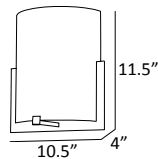

②



③

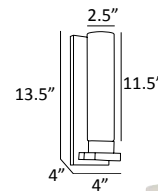

④

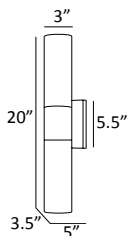

⑤

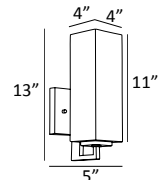
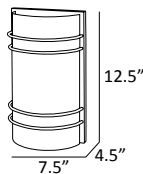

⑥



LS-1673 ① · Checks Sconce

Hardware: Brushed Nickel / Metal
Shade: Frosted / Glass
Lamp: E-12 Candelabra Base (Max. 60W)
Features: ADA

LS-16222SS/FRO ④ · Strokes Sconce

Hardware: Satin Nickel / Metal
Shade: Frosted / Glass
Lamp: E-27 Medium Base (Max. 60W) x2
Features: 2-Light

LS-16020PS/FRO ② · Windsor Sconce

Hardware: Brushed Nickel / Metal
Shade: Frosted / Glass
Lamp: GU24 Base (Max. 13W) x2
Features: ADA, Fluorescent Bulbs Included

LS-16643 ⑤ · Gyala Sconce

Hardware: Brushed Nickel / Metal
Shade: Frosted / Glass
Lamp: E-27 Medium Base (Max. 60W) x2
Features: ADA, 2-Light

LS-16023C/FRO ③ · Kayla Sconce

Hardware: Chrome / Metal
Shade: Frosted / Glass
Lamp: GU24 Base (Max. 26W)
Features: ADA, Fluorescent Bulb Included

LS-16670PS/FRO ⑥ · Cairbre Sconce

Hardware: Brushed Nickel / Metal
Shade: Frosted / Glass
Lamp: E-27 Medium Base (Max. 60W)

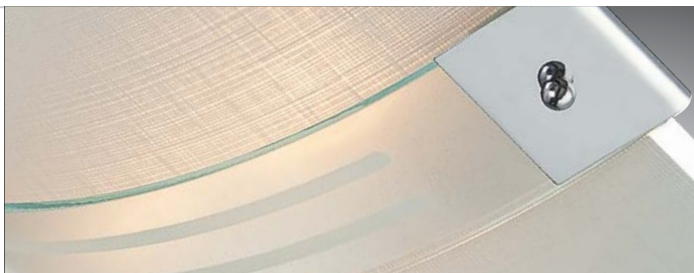

①

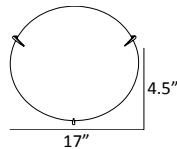
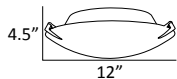
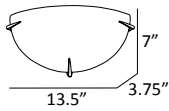

③



②



④

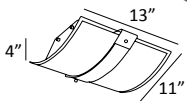

⑥

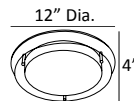

Wall Mount
Convertible



⑤

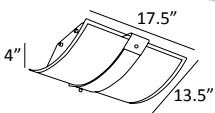

⑦

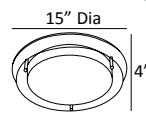

LS-1338PS/FRO ① · Nick Sconce

Hardware: Polished Steel / Metal
Shade: Frosted / Glass
Lamp: E-27 Medium Base (Max. 60W)
Features: ADA

LS-5337PS/FRO ② / LS-5338PS/FRO ③ · Nick Flush Mount

Hardware: Polished Steel / Metal
Shade: Frosted / Glass
Lamp: E-27 Medium Base (Max. 60W) x2 ② / x3 ③

LS-5430 ④ / LS-5431 ⑤ · Vincenzo Flush Mount

Hardware: Chrome / Metal
Shade: Frosted w. Clear Edge / Glass
Lamp: E-27 Medium Base (Max. 60W) x2 ④ / x4 ⑤

LS-5588 ⑥ / LS-5589 ⑦ · Belmont Flush Mount

Back Plate: Mirror / Metal
Shade: Frosted Glass / Clear Acrylic
Lamp: E-12 Candelabra Base (Max. 40W) x2
Features: Convertable to Wall Sconce

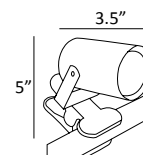
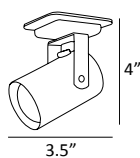
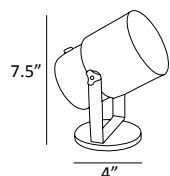

LS-113BLK ①

LS-113PS ②

LS-113WHT ③ · "Pin-Up" Spotlight

Body: Black, Polished Steel or White / Metal

Shade: Matching Finish / Metal

Switch: On/Off In-Line

Lamp: E-27 Medium Base (Max. 75W)

Features: **Adjustable Shade**

LS-117BLK ④

LS-117WHT ⑤

LS-119BLK ⑥ · "Mini-Spot" Spotlight

Body: Black or White / Metal

Shade: Matching Finish / Metal

Switch: On/Off In-Line

Lamp: R-14 Incandescent Bulb (Max. 25W)

Features: **Bulb Included, Adjustable Shade, Clip-On ⑥**

Product Index

ITEM NO.	PAGE NO.	ITEM NO.	PAGE NO.	ITEM NO.	PAGE NO.	ITEM NO.	PAGE NO.	ITEM NO.	PAGE NO.
LS 105	211	LS 2449	116	LS 5572	266	LS 9401	202	LS 16210	293
LSF 105	211	LS 2744	204	LS 5573	266	LS 9406	200	LS 16220	243
LS 111	208	LS 2875	15	LS 5576	265	LSF 9406	200	LS 16221	243
LSF 111	208	LS 2937	117	LS 5588	298	LS 9485	185	LS 16222	297
LS 113	299	LSF 2937	117	LS 5589	298	LS 9640	232	LS 16280	194
LSF 113	299	LS 2996	56	LS 5620	261	LSF 9640	232	LS 16328	291
LS 114	208	LS 2996/2PK	56	LS 5700	258	LS 9709	79	LS 16350	291
LSF 114	208	LS 2997	56	LS 5707	258	LS 9913	78	LS 16381	295
LS 117	299	LS 2997/2PK	56	LS 5708	258	EL 10070	254	LS 16446	296
LS 119	299	LS 2998	56	LS 5822	263	EL 10071	254	LS 16456	165
LSC 163	213	LS 2998/2PK	56	LS 5866	35	EL 10076	255	LS 16512	264
LSM 180	155	LS 2999	56	LS 5912	264	EL 10077	255	LS 16515	290
LSM 180	213	LS 2999/2PK	56	LS 5915	244	EL 10100	250	LS 16524	272
LSM 181	213	LS 3414	202	LS 5916	244	EL 10101	250	LS 16525	272
LSM 199	155	LS 3421	202	IK 6100	74	EL 10102	251	LS 16572	266
LS 211	215	LS 3640	232	IK 6101	74	EL 10103	251	LS 16581	259
LSF 211	215	LS 3821	65	IK 6102	74	EL 10104	251	LS 16583	259
LS 224	205	LS 3896	204	IK 6105	74	EL 10165	256	LS 16585	290
LS 306	151	C 4333	233	C 6333	233	EL 10166	256	LS 16586	290
LS 398	205	CF 4333	233	CF 6333	233	EL 10174	249	LS 16643	297
LSP 801	212	LS 5337	298	C 6334	233	EL 10175	249	LS 16670	297
LS 960	184	LS 5338	298	CF 6334	233	LS 13371	296	LS 16681	296
LS 974	184	LS 5419	246	LS 8530	216	LS 14631	261	LS 16706	292
LS 1101	184	LS 5419	247	LS 8540	77	LS 16020	297	LS 16707	292
LS 1338	298	LS 5420	246	LS 8550	190	LS 16023	297	LS 16727	292
LS 1395	294	LS 5420	247	LS 8870	13	LS 16068	145	LS 16753	291
LS 1425	281	LS 5430	298	LS 8871	13	LS 16105	294	LS 16767	292
LS 1468	296	LS 5431	298	LSF 8871	13	LS 16112	295	LS 16788	293
LS 1673	297	LS 5524	272	LS 8872	12	LS 16145	195	LS 16803	296
LS 1693	294	LS 5569	267	LSF 8872	12	LS 16146	289	LS 16815	33
LS 2318	76	LS 5570	267	LS 8875	15	LS 16191	253	LS 16822	263

Product Index

ITEM NO.	PAGE NO.	ITEM NO.	PAGE NO.	ITEM NO.	PAGE NO.	ITEM NO.	PAGE NO.	ITEM NO.	PAGE NO.
LS 16836	294	LS 19037	261	LS 19570	258	LS 19991	285	LS 21618	116
LS 16838	294	LS 19038	261	LS 19577	255	LS 19998	260	LS 21652	64
LS 16885	295	LS 19041	260	LS 19581	259	LS 20073	75	LS 21658	123
LS 16917	290	LS 19043	260	LS 19586	280	LS 20474	228	LS 21719	156
LS 16919	290	LS 19045	260	LS 19598	276	LS 20585	72	LS 21788	83
LS 16936	293	LS 19049	279	LS 19602	278	LS 20700	105	LS 21797	73
LS 16937	293	LS 19093	93	LS 19616	275	LSF 20700	105	LS 21826	65
LS 16949	293	LS 19105	283	LS 19682	287	LS 20751	26	LS 21892	65
LS 16977	295	LS 19112	285	LS 19689	286	LSF 20751	26	LS 21910	74
LS 16979	290	LS 19130	9	LS 19692	286	LS 20812	228	LS 21979	70
LS 17851	284	LS 19132	9	LS 19727	275	LS 20830	71	LS 21983	75
LS 17971	281	LS 19133	11	LS 19733	277	LS 20844	76	LS 21986	120
LS 18191	252	LS 19149	276	LS 19772	284	LS 20847	238	LS 22040	224
LS 18194	252	LS 19152	275	LS 19791	168	LSF 20847	238	LS 22048	157
LS 18195	252	LS 19160	14	LS 19798	287	LS 20855	76	LS 22069	116
LS 18198	253	LS 19174	30	LS 19808	280	LS 21024	122	LS 22072	3
LS 18456	164	LS 19213	280	LS 19821	263	LS 21270	98	LSF 22072	3
LS 18456	165	LS 19215	271	LS 19822	263	LS 21276	201	LS 22075	67
LS 18571	267	LS 19216	271	LS 19830	283	LS 21282	117	LSF 22075	67
LS 18572	266	LS 19221	243	LS 19855	268	LS 21330	116	LS 22079	119
LS 18575	265	LS 19222	243	LS 19866	35	LSF 21330	116	LSF 22079	119
LS 18626	37	LS 19368	260	LS 19888	283	LS 21396	64	LS 22080	145
LS 18641	280	LS 19377	284	LS 19889	268	LS 21437	228	LS 22110	210
LS 18668	145	LS 19381	295	LS 19921	33	LS 21455	163	LS 22130	70
LS 18770	276	LS 19420	246	LS 19922	279	LS 21456	164	LS 22139	27
LS 18811	183	LS 19420	247	LS 19923	33	LS 21456	165	LS 22139	109
LS 18870	12	LS 19512	264	LS 19927	278	LS 21478	154	LS 22160	14
LS 18959	276	LS 19516	245	LS 19937	283	LS 21489	71	LS 22174	30
LS 18997	269	LS 19519	277	LS 19959	284	LS 21506	75	LS 22205	116
LS 18998	269	LS 19523	272	LS 19976	281	LS 21513	76	LS 22215	38
LS 19017	167	LS 19524	272	LS 19982	285	LS 21519	30	LS 22225	17

Product Index

ITEM NO.	PAGE NO.	ITEM NO.	PAGE NO.	ITEM NO.	PAGE NO.	ITEM NO.	PAGE NO.	ITEM NO.	PAGE NO.
LS 22239	70	LS 22473	64	LSF 22674	120	LS 22780	203	LS 22888	31
LS 22260	229	LS 22477	152	LS 22675	114	LS 22783	175	LS 22890	61
LS 22280	194	LS 22479	152	LS 22676	123	LS 22784	100	LS 22891	63
LS 22283	64	LS 22514	62	LS 22680	156	LS 22786	108	LS 22893	122
LS 22292	154	LS 22517	62	LS 22682	201	LS 22787	235	LS 22894	204
LS 22303	234	LS 22525	64	LS 22690	120	LS 22788	234	LS 22896	121
LS 22305	34	LS 22526	114	LS 22695	149	LS 22797	191	LS 22899	68
LS 22311	209	LS 22535	209	LS 22696	149	LS 22804	154	LS 22923	33
LS 22312	210	LS 22538	206	LS 22700	68	LS 22805	154	LS 22940	171
LS 22315	72	LS 22542	121	LS 22705	191	LS 22808	64	LS 22942	76
LS 22316	49	LS 22547	123	LS 22707	102	LS 22811	183	LS 22944	71
LS 22324	156	LSF 22547	123	LS 22711	62	LS 22815	63	LS 22947	114
LS 22336	28	LS 22564	121	LS 22712	62	LS 22816	63	LSF 22947	114
LS 22337	170	LS 22570	67	LS 22717	65	LS 22820	152	LS 22949	121
LS 22339	148	LSF 22570	67	LS 22720	74	LS 22823	157	LS 22952	200
LS 22355	48	LS 22571	67	LS 22729	106	LS 22828	177	LS 22960	73
LS 22374	182	LS 22576	61	LS 22733	23	LS 22830	176	LS 22997	56
LS 22375	203	LS 22580	206	LS 22735	68	LS 22831	238	LS 23005	208
LS 22378	75	LS 22595	200	LS 22737	178	LS 22833	107	LS 23012	123
LS 22386	68	LS 22604	173	LS 22743	114	LS 22834	235	LS 23013	123
LS 22393	150	LS 22615	120	LS 22746	191	LS 22835	180	LS 23017	167
LS 22394	157	LS 22620	68	LS 22747	122	LS 22856	61	LS 23020	101
LS 22396	150	LS 22623	36	LS 22749	62	LS 22866	35	LS 23021	4
LS 22397	152	LS 22626	37	LS 22750	191	LS 22868	106	LS 23022	4
LS 22399	151	LS 22630	65	LS 22751	191	LS 22872	62	LS 23032	19
LS 22400	157	LS 22638	29	LS 22754	122	LS 22877	70	LS 23035	99
LS 22443	63	LS 22655	119	LS 22755	76	LS 22880	61	LS 23037	7
LS 22446	63	LS 22660	114	LS 22757	122	LS 22881	61	LS 23042	48
LS 22450	206	LSF 22660	114	LS 22762	179	LS 22883	71	LS 23045	20
LS 22453	67	LS 22665	68	LS 22764	108	LS 22885	70	LS 23046	199
LS 22464	156	LS 22674	120	LS 22767	34	LS 22887	69	LS 23048	21

Product Index

ITEM NO.	PAGE NO.	ITEM NO.	PAGE NO.	ITEM NO.	PAGE NO.	ITEM NO.	PAGE NO.	ITEM NO.	PAGE NO.
LS 23050	25	LS 23130	9	LS 23208	49	EL 50174	249	LS 81270	98
LS 23052	237	LS 23133	11	LS 23212	54	C 61151	231	LS 81276	201
LS 23055	58	LS 23135	94	LS 23217	133	CF 61151	231	LS 81277	126
LS 23056	113	LS 23140	131	LS 23219	117	C 61195	241	LS 81455	163
LS 23057	113	LS 23142	113	LS 23264	89	C 61289	240	LS 81456	164
LS 23058	113	LS 23145	195	LS 23998	57	C 61394	223	LS 81456	165
LS 23060	111	LS 23147	48	LS 23999	57	C 61396	219	LS 81457	163
LS 23062	112	LS 23148	48	LS 24997	57	C 61397	221	LS 81571	128
LS 23063	58	LS 23153	47	C 41117	229	C 61398	225	LS 81615	215
LS 23065	111	LS 23155	49	C 41151	231	C 61399	225	LSF 81615	215
LS 23072	59	LS 23157	97	CF 41151	231	C 71357	274	LS 81699	79
LS 23074	3	LS 23158	22	C 41160	239	C 71358	274	LS 81724	190
LS 23076	81	LS 23165	1	C 41225	239	C 71359	274	LS 81746	39
LS 23077	83	LS 23167	3	C 41267	228	C 71390	277	LSF 81746	39
LS 23079	103	LS 23170	111	C 41294	239	C 71392	222	LS 81789	83
LS 23082	147	LS 23172	49	CF 41294	239	C 71393	222	LS 81832	241
LS 23083	146	LS 23180	112	C 41320	238	C 71394	222	LSF 81832	241
LS 23085	59	LS 23181	53	C 41341	226	C 71396	219	LS 81866	38
LS 23086	113	LS 23183	53	C 41344	239	C 71402	220	LS 81922	212
LS 23088	47	LS 23184	53	C 41362	238	LS 80442	240	LS 81942	240
LS 23089	47	LS 23186	112	C 41383	229	LS 80700	105	LSF 81942	240
LS 23090	47	LS 23187	53	C 41384	229	LSF 80700	105	LS 81990	77
LS 23093	93	LS 23190	52	C 41385	226	LS 80701	105	LS 82040	224
LS 23095	69	LS 23194	193	C 41386	226	LSF 80701	105	LS 82041	224
LS 23098	92	LS 23196	112	C 41389	226	LS 80708	127	LS 82053	43
LS 23100	91	LS 23197	111	C 41394	223	LS 80751	26	LS 82065	40
LS 23101	85	LS 23199	51	C 41396	219	LSF 80751	26	LS 82100	188
LS 23112	86	LS 23200	50	C 41397	221	LS 80753	26	LS 82116	214
LS 23113	87	LS 23202	55	C 41398	225	LS 80910	78	LSF 82116	214
LS 23120	197	LS 23203	55	C 41402	220	LS 80984	129	LS 82117	214
LS 23125	96	LS 23204	54	EL 50100	250	LS 81165	204	LSF 82117	214

Product Index

ITEM NO.	PAGE NO.	ITEM NO.	PAGE NO.	ITEM NO.	PAGE NO.	ITEM NO.	PAGE NO.	ITEM NO.	PAGE NO.
LS 82138	27	LS 82632	160	LS 82866	35	LS 83038	6	LS 83117	187
LS 82138	109	LS 82633	161	LS 82868	106	LSF 83038	6	LS 83118	187
LS 82139	27	LS 82638	29	LS 82888	31	LS 83039	7	LS 83120	196
LS 82139	109	LS 82668	145	LS 82902	142	LSF 83039	7	LSF 83120	196
LS 82174	30	LS 82703	108	LS 82923	33	LS 83040	6	LS 83125	96
LS 82213	126	LS 82707	102	LS 82929	143	LSF 83040	6	LS 83127	141
LS 82215	38	LS 82710	139	LS 82931	161	LS 83045	20	LS 83130	9
LS 82225	17	LS 82732	77	LS 82933	159	LS 83048	21	LS 83131	10
LSF 82225	17	LS 82733	23	LS 82934	159	LS 83050	25	LS 83132	10
LS 82232	36	LS 82734	23	LS 82936	161	LS 83051	41	LSF 83132	10
LS 82268	43	LS 82737	178	LS 82939	45	LS 83052	237	LS 83133	11
LSF 82268	43	LS 82762	179	LS 82940	171	LS 83053	237	LS 83135	94
LS 82280	194	LS 82767	34	LS 82953	216	LS 83066	134	LS 83136	94
LS 82329	160	LS 82783	175	LS 82954	216	LS 83067	134	LS 83137	94
LS 82336	28	LS 82784	100	LSF 82954	216	LS 83068	134	LS 83140	131
LS 82337	170	LS 82788	234	LS 82962	190	LS 83069	134	LS 83145	195
LS 82341	188	LS 82791	168	LS 83017	167	LS 83076	81	LS 83150	17
LS 82374	182	LS 82793	169	LS 83018	166	LS 83078	81	LS 83157	97
LS 82488	160	LS 82795	12	LS 83019	166	LS 83079	103	LS 83158	22
LS 82531	127	LS 82795	169	LS 83020	101	LS 83098	92	LS 83163	14
LS 82533	127	LS 82811	183	LS 83022	4	LS 83100	91	LSF 83163	14
LSF 82533	127	LS 82818	188	LS 83023	137	LS 83101	85	LS 83165	1
LS 82550	128	LS 82828	177	LS 83024	136	LS 83102	84	LS 83194	193
LS 82595	200	LS 82830	176	LS 83026	159	LS 83103	84	LS 83215	45
LS 82597	189	LS 82833	107	LS 83028	44	LS 83104	90	LS 83217	133
LS 82604	173	LS 82834	235	LS 83030	189	LS 83106	90	LS 83264	89
LS 82605	173	LS 82835	180	LS 83032	19	LS 83107	25	LS 83266	45
LS 82605	174	LS 82838	217	LS 83033	18	LSF 83107	25		
LS 82623	36	LS 82839	126	LSF 83033	18	LS 83112	86		
LS 82626	37	LS 82842	138	LS 83035	99	LS 83113	87		
LS 82628	77	LS 82844	125	LS 83037	7	LS 83115	125		

Here goes your note :P

Thank U ! :)

2018 *Portable & Fixture Collections*



Lite Source Showrooms Dallas • Trade Mart #4925 | High Point • IHFC #D417 | Las Vegas • WMC #A310

Please note products photographed for this catalogue are as visually accurate as possible. Slight variations in color, size, and viewable design occur when being photographed. These variations in no way impair the product or its quality and usability.



4980 Eucalyptus Ave. Chino, CA 91710 • Tel. 909.597.8892 • Fax. 909.393.4161
website: www.lite-source.com • e-mail: info@lite-source.com

© Copyright 2018 Lite Source Inc. All rights reserved.



\$20.00 Call for a Catalog or Additional Information