



oxygen

LIGHTING & FANS

2018 | 2019



oxygen

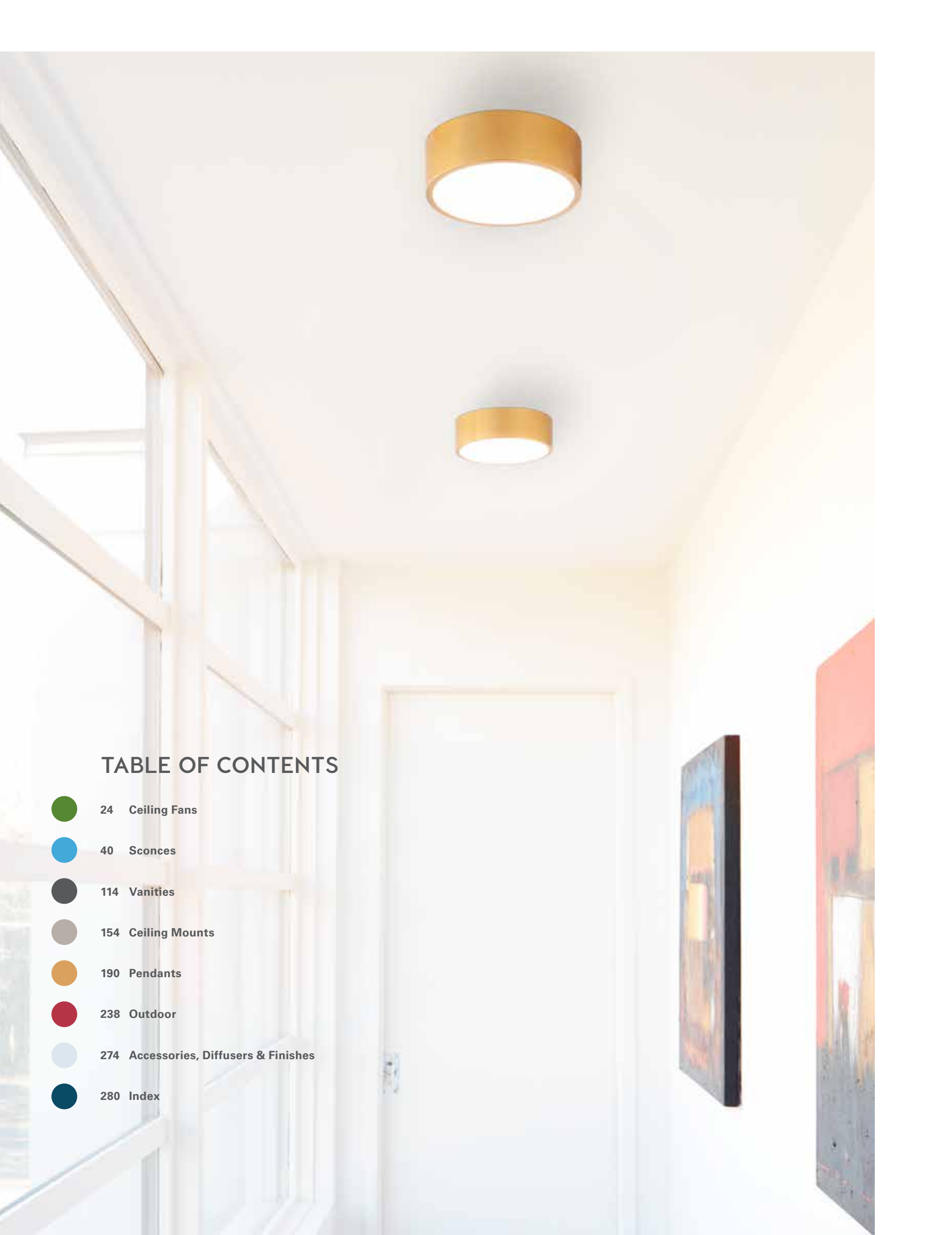

TABLE OF CONTENTS

-  24 Ceiling Fans
-  40 Sconces
-  114 Vanities
-  154 Ceiling Mounts
-  190 Pendants
-  238 Outdoor
-  274 Accessories, Diffusers & Finishes
-  280 Index



INTRODUCING CEILING FANS



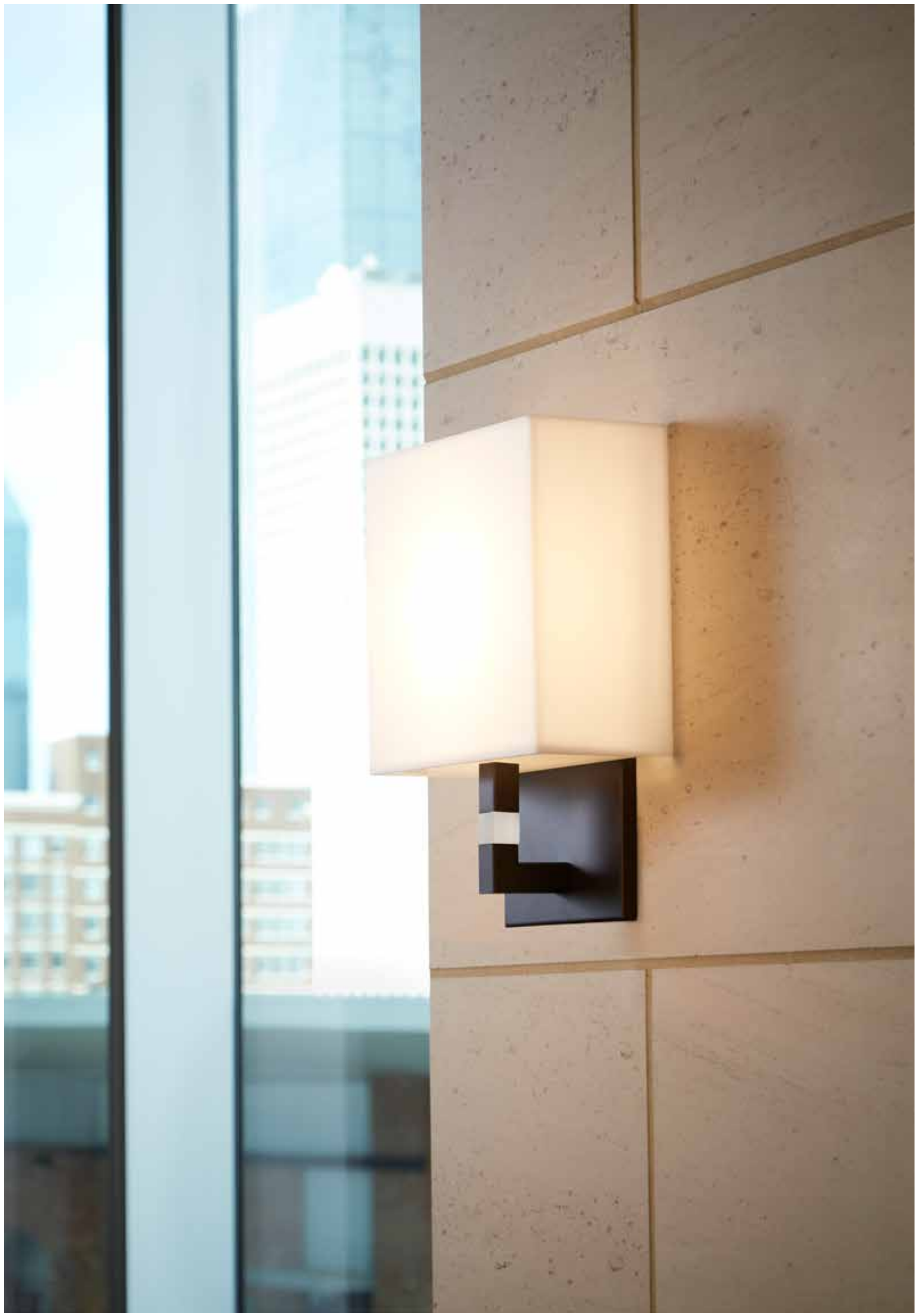

SPECIFIER INSTRUCTIONS

THE PRODUCT DIAGRAM

indicates how the measurements of the fixture are determined and contains an approximate "human-scale" drawing of the fixture.

THE SPEC CHART

for each fixture indicates which diffusers are available with each finish as well as lamping information and dimensions. If there are options available they will be indicated along with a sample product number to aid in specifying the options. Specs may be highlighted to help distinguish differences between similar looking products.

GENERAL SPECIFICATIONS

such as housing, trim, diffuser thicknesses and how to obtain additional information from Oxygen.

DEFINITIONS/HOW-TO'S

ITEM # - fixture model number

PREFIX NOTES:

2-597-XXX = fluorescent model (or incandescent)

3-587-XXX = 120v LED model

37-587-XXX = 277v LED model

32-XXX-XXX = 120/277 UV LED model

MODEL SERIES:

2-**597-XXX** - **597** = Beacon fluorescent series

3-**587-XXX** - **587** = Beacon LED series

DIFFUSER/FINISH:

2-597-**124** = White Cotton (1) w/ Satin Nickel (24) finish

3-587-**295** = Matte White Acrylic (2) w/ Old World (95) finish

DIFFUSER - type of diffuser or options available for model.

FINISH - finish/ finishes available for model.

DIMENSIONS - fixture dimensions as indicated in product diagram illustration.

LAMPING - lamp type (incandescent, fluorescent or LED), wattage and other pertinent information for lamp specified.

BALLAST - ballast specifications for fluorescent models.

DRIVER - driver specifications for LED models.

CERTIFICATION - compliance standards mark for fixture model. Also indicates damp/ wet listings, ADA compliance, emergency ballast and energy star items.

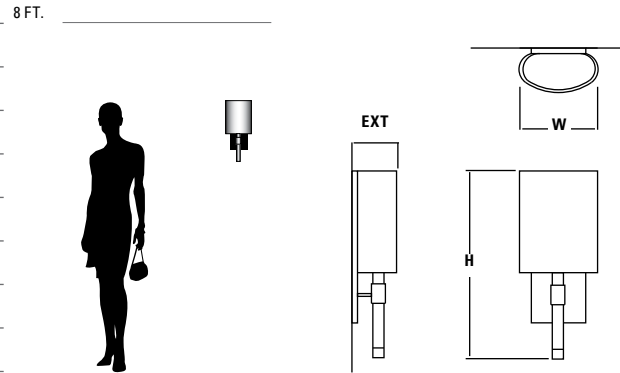

GENERAL SPECIFICATIONS:

- Cold rolled steel backplate and trim. • Clear, polished resin accent.
- Fabric shade is white cotton. • Acrylic shade is 1/8", matte white finish.
- White acrylic top and bottom lenses. • Unit mounts to 4" octagonal junction box. • Toolless access to lamps for fluorescent models. • Total luminaire power 10.4w for LED models. • Visit www.oxygenlighting.com for technical cut sheets. • Oxygen reserves the right to modify designs at any time.

SAMPLE SPECIFICATION CHART

AVAILABLE FINISHES



ITEM #	DIFFUSER	FINISH	DIMENSIONS	LAMPING	BALLAST	DRIVER	CERTIFICATION
2-597-XXX	1 White Cotton 2 Matte White Acrylic	24 Satin Nickel 95 Old World	7"(w) x 16.5"(h) x 3.75"(ext)	1 x 26w quad 4-pin fluorescent (G24q-3)	Electronic, HPF, Programmed Start, Universal Voltage (120-277V)	--	ADA COMPLIANT, UL US damp
3-587-XXX	1 White Cotton 2 Matte White Acrylic	24 Satin Nickel 95 Old World	7"(w) x 16.5"(h) x 3.75"(ext)	1 x 8.2w, 90CRI 3000k LED	--	120V 0-10V/Phase dimming	ADA COMPLIANT, ETL US damp
37-587-XXX	1 White Cotton 2 Matte White Acrylic	24 Satin Nickel 95 Old World	7"(w) x 16.5"(h) x 3.75"(ext)	1 x 8.2w, 90CRI 3000k LED	--	277V 0-10V/Phase dimming	ADA COMPLIANT, ETL US damp

2700k, 3500k, 4000k color temperatures also available for LED models. Contact Oxygen for ordering information.

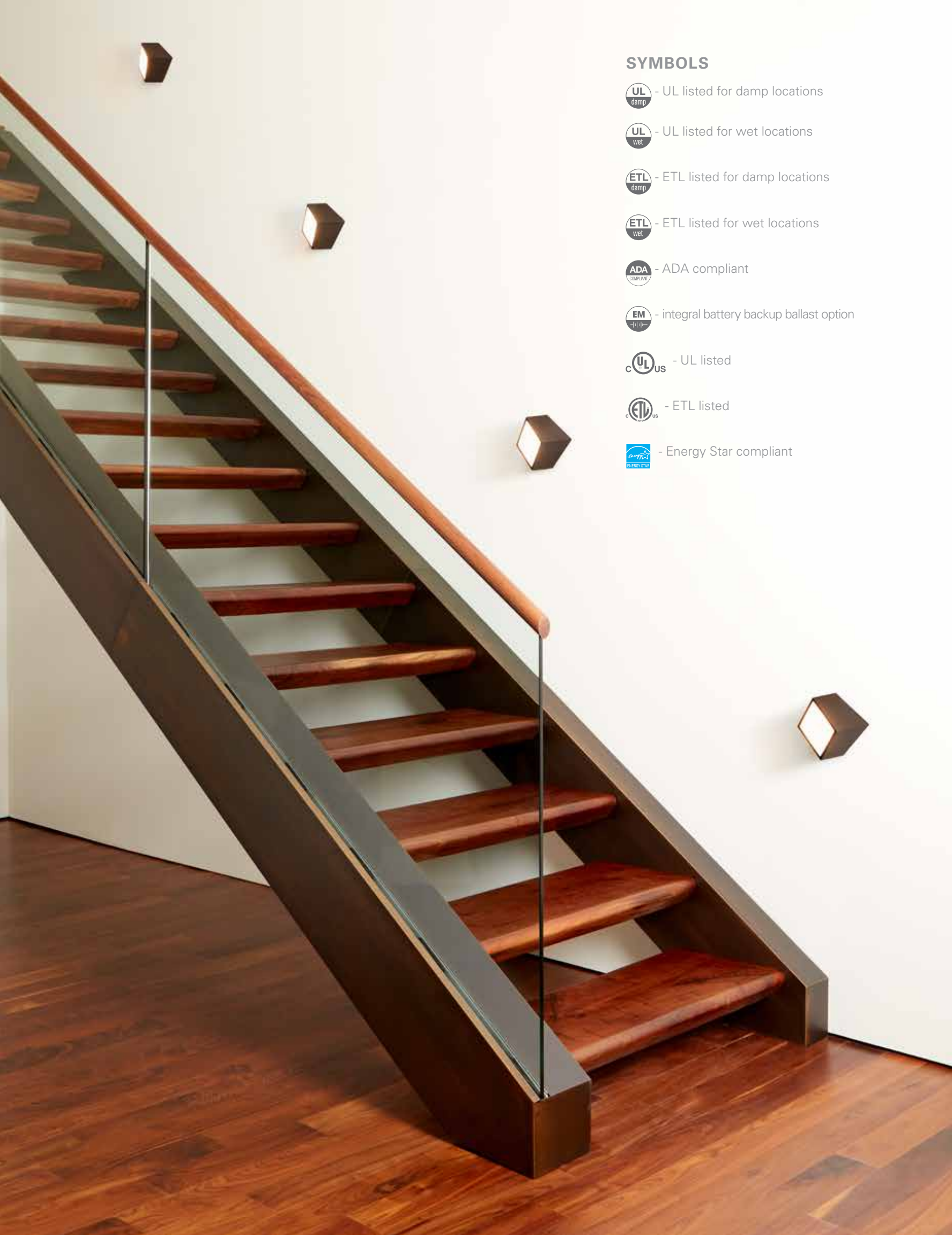

SYMBOLS

 - UL listed for damp locations

 - UL listed for wet locations

 - ETL listed for damp locations

 - ETL listed for wet locations

 - ADA compliant

 - integral battery backup ballast option

 - UL listed

 - ETL listed

 - Energy Star compliant



FAN PERFORMANCE BY ROOM

ROOM SIZE	SQUARE FEET	ROOM TYPE	FAN SWEEP	CUBIC FEET/MINUTE (CFM)
small	80 sq. ft or less	utility room, bathroom, closet	20" - 28"	1500 - 3500
medium	90-120 sq. ft or less	small bedroom, office, bathroom	38" - 52"	3500 - 5000
large	125-300 sq. ft	kitchen, bedroom, dining room, living room	52" - 56"	5000 - 8000
great	350-400 sq. ft	great room, master suite, outdoor	56" - 99"	7000 - 15000

UNDERSTANDING CEILING FANS

FLUSH MOUNT/HUGGER FANS

This type of mount is recommended for 8' ceilings. The National Electric Code requires that all fan blades be a minimum of 7' above the floor.

DOWNROD OPTIONS FOR FANS

For 9' ceilings, a downrod from 4"-8" is installed between the ceiling canopy and the fan. Installing the fan further away from the ceiling allows for more air circulation and fan efficiency. All oxygen fans, with exception of huggers, come with a standard downrod for this application. **For ceilings 10' and above, oxygen offers additional length downrods found on page 278.**

SPECIFIER INSTRUCTIONS

THE PRODUCT DIAGRAM

indicates how the measurements of the fixture are determined and contains an approximate "human-scale" drawing of the fixture.

THE SPEC CHART

for each fan indicates available finishes, blades and options. If there are light kit options available they will be indicated along with a product number to aid in specifying the options. Wall and remote controls will be indicated as well as if they are included or optional.

HEIGHT CHART & FAN HEIGHT

shows the distance from the ceiling to the fan blades and motor.

GENERAL SPECIFICATIONS

will list motor warranty, number of blades, blade sweep and pitch and downrod information.

MECHANICAL SPECIFICATIONS

lists motor type, available options and mechanical performance.

ENERGY SPECIFICATIONS

airflow and energy used on high speed.

DOE ENERGY GUIDE INFORMATION

quick reference of energy specifications.

SAMPLE SPECIFICATION CHART

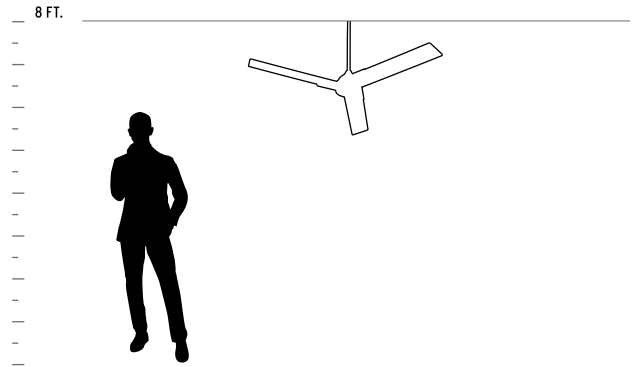

HEIGHT CHART

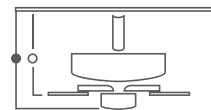

FAN HEIGHT

- Using 4.5" downrod
- Distance of 11.5"
- Distance of 9.125"

GENERAL SPECIFICATIONS:

- Lifetime Motor Warranty. • Three Blades. • 56" Blade Sweep.
- 13.5-Degree Blade Pitch. • 80" Lead Wire. • 4.5" Downrod (Included)
- Additional Downrod options on page 278.

MECHANICAL SPECIFICATIONS:

- 120mm DC Motor. • 3 Speeds-Reversible with wall control. • 8 Poles.
- .43/.07 AMPS on H/L • 28/3 WATTS on H/L • 166/72 RPMS on H/L.
- Wall Control Included.

ENERGY SPECIFICATIONS:

- Energy Information at High Speed. • Airflow: 5238 Cubic Feet/Minute.
- Electricity Use: 28 Watts (Excludes Lights). • Airflow Efficiency: 187 Cubic Feet/Minute/Watt.

DOE ENERGY GUIDE INFORMATION

- Airflow 3815 cfm. • Watts 18. • Airflow efficiency 208 cfm/w.
- Estimated yearly energy cost \$5.

AVAILABLE FINISHES



6 White





20 Polished Nickel



22 Oiled Bronze



24 Satin Nickel

ITEM #	FINISH	BLADES	LED LIGHT KIT (optional)	WALL CONTROL (included)	CERTIFICATION
3-103-XX	6 White 20 Polished Nickel 22 Oiled Bronze 24 Satin Nickel	White Silver Oiled Bronze Silver	 3-9-102 15w, 3000k, 90CRI Dimmable LED w/ Matte White Polycarbonate Diffuser		









A photograph of a living room viewed through a large circular opening in a wall. The room is brightly lit, featuring a light-colored sofa with several pillows, a coffee table, and a vase of pink flowers. A warm, glowing light fixture is visible on the wall. The foreground is a dark, out-of-focus area, possibly a rug or another part of the room.

YOU NEED OXYGEN



VISUAL TABLE OF CONTENTS

CEILING FANS



ALPHA 26



CODA 28



COSMO 30



OLSO 32



OSLO HUGGER 34



PROPEL 36



SOL 38

sconces



ALCOR 42
ADA | LED



APOLLO 44
ADA | LED | ES



BEACON 46
ADA | LED



CHAMELEON 48
ADA | LED



CORNETA 56
ADA



CRESCENT 58
ADA | LED



DUO 60
ADA | LED



ELEMENTS 62
ADA | LED



EPOCH 64
ADA | LED



HALO 66
ADA | LED



ICON 68
ADA | LED



KIKO 70
ADA | LED



MAGNETA 72
ADA | LED



MAGNUM 74
ADA | LED



METRIX 76
ADA | LED

VISUAL TABLE OF CONTENTS



MIES 78
ADA | LED



MIRAGE 80
ADA | LED



MIZAR 82
ADA | LED



OLIO 84
ADA | LED



OLIO 86
ADA | LED



ORION 88
ADA | LED



PATHWAYS 90
ADA | LED | EM



PEBBLE 92



POLARIS 94
ADA | LED | EM



PROFILE 96
ADA | LED



REFLEX 98
ADA | LED



SIREN 100
ADA | LED



SONGBIRD 102
ADA | LED



UNO 104
ADA | LED



VEGA 106
ADA | LED



VELA 108
ADA | LED

VISUAL TABLE OF CONTENTS



ZEEPERS 110
ADA | LED



ZETA 112
ADA | LED

VANITIES



ADAGIO 116
ADA | LED



ADELPHI 118
ADA | LED | ES



APOLLO 120
ADA | LED | ES



ARCHER 124
ADA | LED



AXEL 126
ADA | LED



BALANCE 128
ADA | LED



CRESCENT 132
ADA | LED



FUSE 134
ADA | LED | ES



HORIZON 136
LED



MAGNETA 138
ADA | LED



MAGNUM 140
ADA | LED



METRIX 142
ADA | LED



PEBBLE 144
ADA



PLATO 146
ADA | LED



SKYLINE 148
ADA



ZENITH 150
ADA



ZENITH II 152
ADA | LED

CEILING
MOUNTS



DIONE 156
ADA | LED | EM



ECHO 158
LED | EM



ELLIPSE 160
LED

VISUAL TABLE OF CONTENTS



iO 162
LED | EM



JOURNEY 164
LED | ES | EM



MODULO 170
LED | EM



ORACLE 172
ADA | LED | ES | EM



PEEPERS 178
ADA | LED | EM



PILAR 182
LED



PYXIS 184
ADA | LED



RHYTHM 188
ADA | LED

PENDANTS



COMET 192
LED



CORNET 194
LED



DIONE 196
LED



ECHO 198
LED | ES



ELEMENTS 200
LED



GALAXY 202
LED



GRATIS 204
LED

VISUAL TABLE OF CONTENTS



IDOL 206
LED



INA 208



KLONE 210
LED



LIBERTY 212
LED



LOTUS 214



LUNA 216
LED



MAGNETA 218
LED



MAGNUM 222
LED



OPUS 224
LED



PYRUS 226
LED



RUVU 228
LED



SIGMA 230
LED



SPINDLE 232
LED



VIDA 234
LED



ZEPP 236
LED

OUTDOOR

VISUAL TABLE OF CONTENTS



CALYPSO 240
ADA | LED



CELENA 242
ADA | LED



CERES 244
LED



DEVA 246
ADA | LED



DUO 248
ADA | LED



ECLIPSE 250
LED



ELIF 252
ADA | LED



ERIS 254
ADA | LED



KARME 256
ADA | LED



LEDA 258
LED | EM



MAGNETA 260
ADA | LED



MAIA 262
ADA | LED



REALM 264
LED



REGIO 266
ADA | LED



SCOPE 268
LED



TELHOR 270
LED | EM



UNO 272
ADA | LED

A large white circle is centered on a dark brown wood grain background. The wood grain is vertical and has a rich, textured appearance. The circle is a simple white outline with a consistent thickness.

ceiling fans

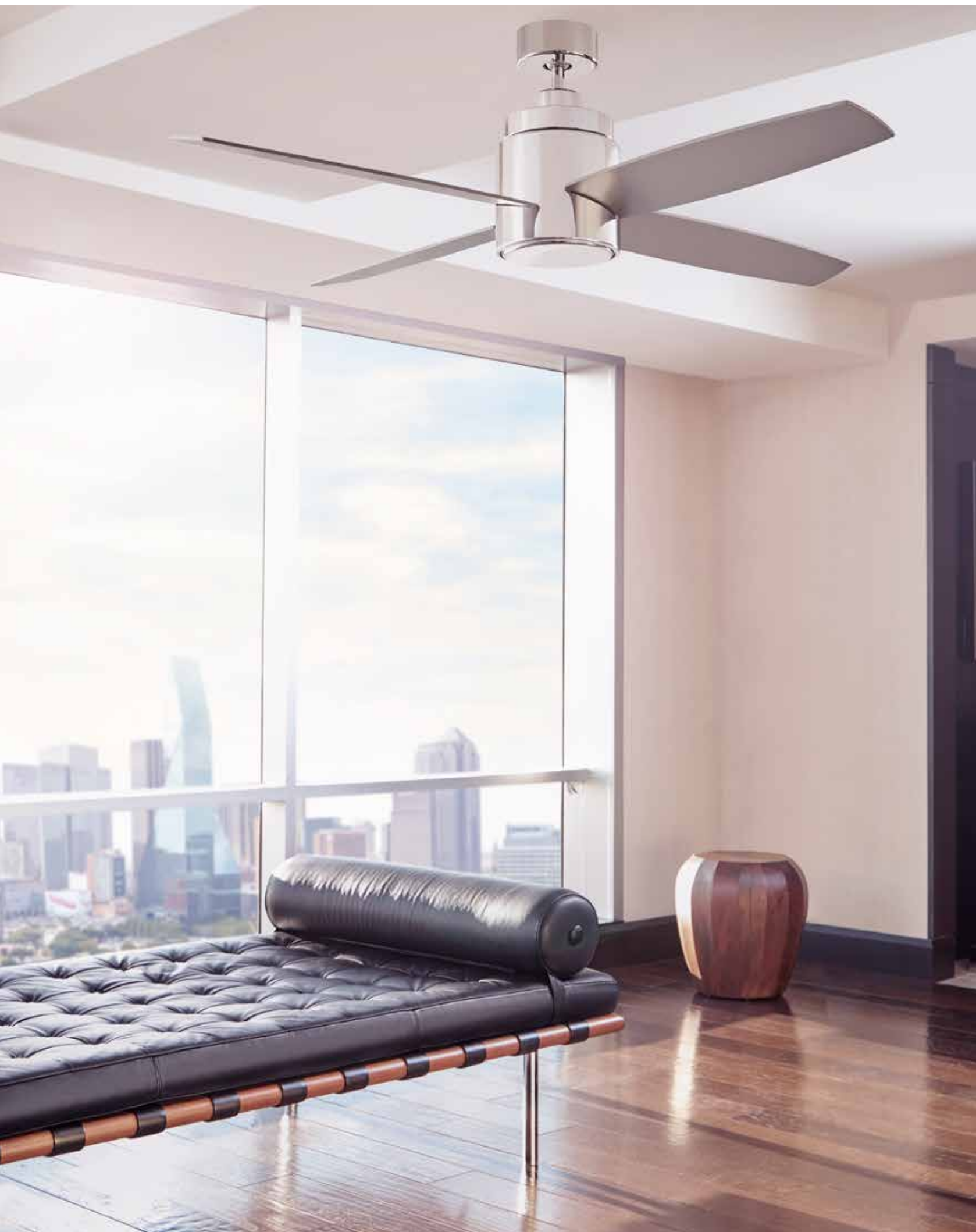

ALPHA 60" CEILING FAN



3-105-024
shown with **3-8-61324** blades

ALPHA 60" CEILING FAN

HOW TO ORDER THE ALPHA FAN:

A. First Pick the Housing/Motor Finish from below:

- 3-105-06 White
- 3-105-022 Oiled Bronze
- 3-105-024 Satin Nickel

B. Then Choose the Blade Finish from below:

- 3-8-61306 White
- 3-8-61322 Walnut
- 3-8-61324 Silver

*Note - Housing/Motor and Blades options will ship separately.

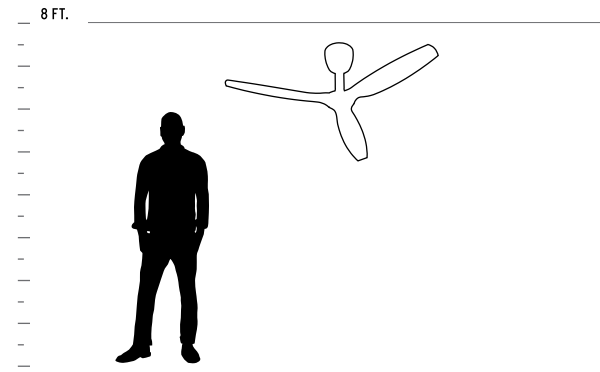
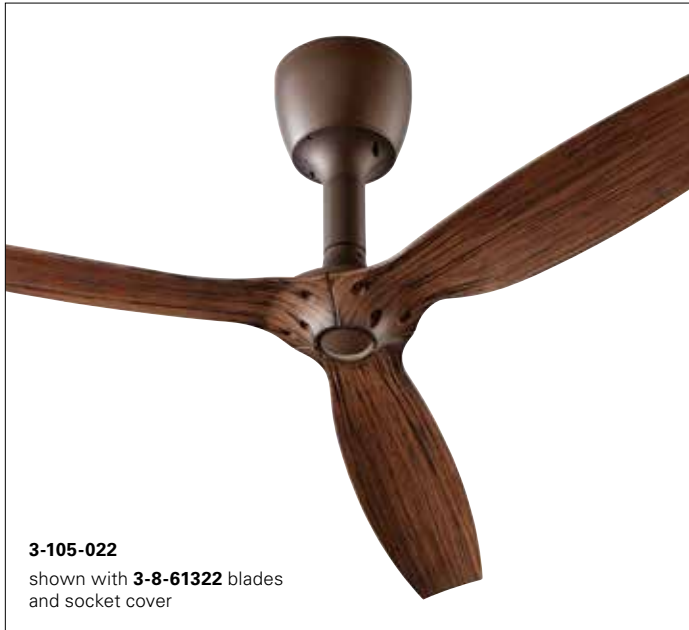

HEIGHT CHART

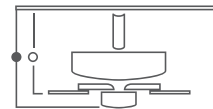

FAN HEIGHT

- Distance of 18"
- Distance of 16"

GENERAL SPECIFICATIONS:

- Lifetime Motor Warranty. • Three Blades. • 60" Blade Sweep. • 18-Degree Blade Pitch. • 58" Lead Wire.

MECHANICAL SPECIFICATIONS:

- 125mm DC Motor. • 6 Speeds-Reversible with wall control. • 12 Poles. • .44/.07 AMPS on H/L • 32/3 WATTS on H/L • 133/50 RPMS on H/L. • Wall Control Included. • Finished socket cover included.

ENERGY SPECIFICATIONS:

- Energy Information at High Speed. • Airflow: 8200 Cubic Feet/Minute. • Electricity Use: 32 Watts (Excludes Lights). • Airflow Efficiency: 256 Cubic Feet/Minute/Watt.

DOE ENERGY GUIDE INFORMAITON

- Airflow 5773 cfm. • Watts 22. • Airflow efficiency 267 cfm/w. • Estimated yearly energy cost \$6.

AVAILABLE FINISHES







6 White



22 Oiled Bronze



24 Satin Nickel

ITEM #	FINISH	BLADE SELECTION	OPTIONAL LED LAMP (included)	CONTROLS	CERTIFICATION
3-105-0XX	6 White 22 Oiled Bronze 24 Satin Nickel	3-8-61306 White 3-8-61322 Walnut 3-8-61324 Silver	 7w, 2700k, 80CRI, Dimmable LED GU10 Bulb (Finished Socket Cover Included for use w/o Optional LED Lamp)	 Wall Control (included)  3-8-2000-0 Remote Control (optional)	

CODA 56" CEILING FAN



3-103-6
shown with optional light kit 3-9-102

CODA 56" CEILING FAN



3-103-22



3-103-24
shown with optional light kit **3-9-102**

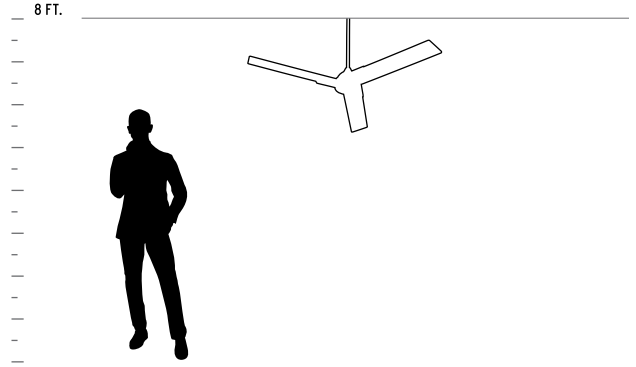

HEIGHT CHART

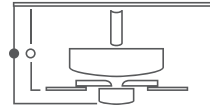

FAN HEIGHT

- Using 4.5" downrod
- Distance of 11.5"
- Distance of 9.125"

GENERAL SPECIFICATIONS:

- Lifetime Motor Warranty. • Three Blades. • 56" Blade Sweep.
- 13.5-Degree Blade Pitch. • 80" Lead Wire. • 4.5" Downrod (Included)
- Additional Downrod options on page 278.

MECHANICAL SPECIFICATIONS:

- 120mm DC Motor. • 3 Speeds-Reversible with wall control. • 8 Poles.
- .43/.07 AMPS on H/L • 28/3 WATTS on H/L • 166/72 RPMS on H/L.
- Wall Control Included.

ENERGY SPECIFICATIONS:

- Energy Information at High Speed. • Airflow: 5238 Cubic Feet/Minute.
- Electricity Use: 28 Watts (Excludes Lights). • Airflow Efficiency: 187 Cubic Feet/Minute/Watt.

DOE ENERGY GUIDE INFORMAITON

- Airflow 3815 cfm. • Watts 18. • Airflow efficiency 208 cfm/w.
- Estimated yearly energy cost \$5.

AVAILABLE FINISHES



6 White





20 Polished Nickel



22 Oiled Bronze



24 Satin Nickel

ITEM #	FINISH	BLADES	LED LIGHT KIT (optional)	WALL CONTROL (included)	CERTIFICATION
3-103-XX	6 White 20 Polished Nickel 22 Oiled Bronze 24 Satin Nickel	White Silver Oiled Bronze Silver	 3-9-102 15w, 3000k, 90CRI Dimmable LED w/ Matte White Polycarbonate Diffuser		

COSMO 70" CEILING FAN



3-100-24

shown with optional light kit 3-9-100

COSMO 70" CEILING FAN

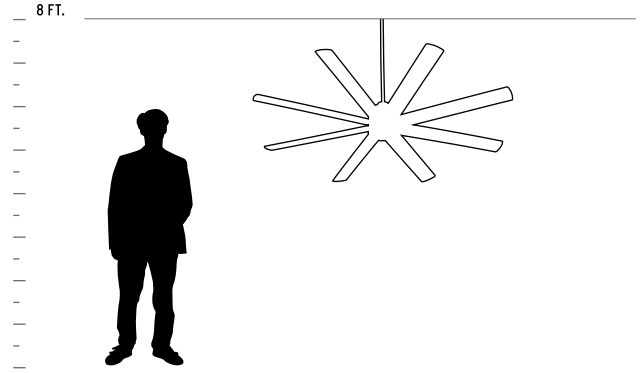

HEIGHT CHART

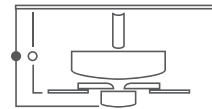

FAN HEIGHT

- Using 4" downrod
- Distance of 13.5"
- Distance of 10.25"

GENERAL SPECIFICATIONS:

- Lifetime Motor Warranty • Eight Blades • 70" Blade Sweep • 14-Degree Blade Pitch • 80" Lead Wire • 4" and 6" Downrod (Included) • Additional Downrod options on page 278.

MECHANICAL SPECIFICATIONS:

- 165mm DC Motor. • 6 Speeds-Reversible with wall control. • 8 Poles.
- .47/.06 AMPS on H/L • 35/3 WATTS on H/L • 114/49 RPMS on H/L.
- Wall Control Included. • Remote Control Adaptable w/ 3-8-2000-0 Remote

ENERGY SPECIFICATIONS:

- Energy Information at High Speed. • Airflow: 9448 Cubic Feet/Minute.
- Electricity Use: 35 Watts (Excludes Lights). • Airflow Efficiency: 184 Cubic Feet/Minute/Watt.

DOE ENERGY GUIDE INFORMAITON

- Airflow 6832 cfm. • Watts 22. • Airflow efficiency 306 cfm/w.
- Estimated yearly energy cost \$6.



AVAILABLE FINISHES



6 White



20 Polished Nickel



22 Oiled Bronze



24 Satin Nickel

ITEM #	FINISH	BLADES	LED LIGHT KIT (optional)	CONTROLS	CERTIFICATION
3-100-XX	6 White 20 Polished Nickel 22 Oiled Bronze 24 Satin Nickel	White Silver Oiled Bronze Silver	 3-9-100 18w, 3000k, 90CRI Dimmable LED w/ Matte White Glass Diffuser	 Wall Control (included)  3-8-2000-0 Remote Control (optional)	

OSLO 52" CEILING FAN



3-101-22
shown with optional light kit **3-9-101**

OSLO 52" CEILING FAN

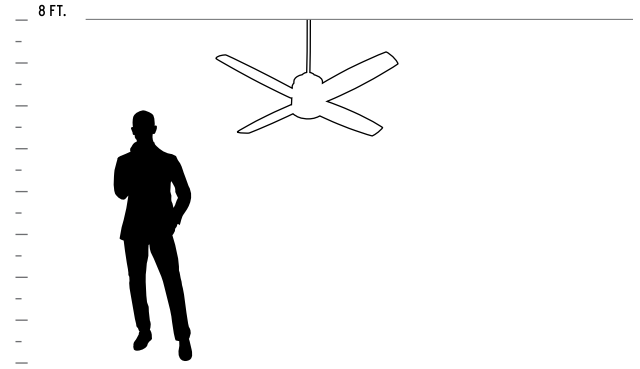

HEIGHT CHART

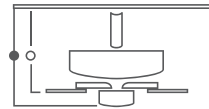

FAN HEIGHT

- Using 4" downrod
- Distance of 14.5"
 - Distance of 11.5"

GENERAL SPECIFICATIONS:

- Lifetime Motor Warranty. • Four Blades. • 52" Blade Sweep.
- 14-Degree Blade Pitch. • 80" Lead Wire. • 4" & 6" Downrods (Included)
- Additional Downrod options on page 278.

MECHANICAL SPECIFICATIONS:

- 188x53 Motor. • 3 Speeds-Reversible with wall control. • 14 Poles.
- .54/.28 AMPS on H/L • 64/16 WATTS on H/L • 147/72 RPMS on H/L.
- Wall Control Included. • Remote Control Adaptable w/ 3-8-1000-0 Remote.

ENERGY SPECIFICATIONS:

- Energy Information at High Speed. • Airflow: 4991 Cubic Feet/Minute.
- Electricity Use: 64 Watts (Excludes Lights). • Airflow Efficiency: 78 Cubic Feet/Minute/Watt.

DOE ENERGY GUIDE INFORMAITON

- Airflow 3770 cfm. • Watts 43. • Airflow efficiency 88 cfm/w.
- Estimated yearly energy cost \$12.



AVAILABLE FINISHES



6 White







20 Polished Nickel



22 Oiled Bronze



24 Satin Nickel

ITEM #	FINISH	BLADES	LED LIGHT KIT (optional)	CONTROLS	CERTIFICATION
3-101-XX	6 White 20 Polished Nickel 22 Oiled Bronze 24 Satin Nickel	White Silver Oiled Bronze Silver	 3-9-101 18w, 3000k, 90CRI, Dimmable LED Matte White Glass Diffuser	 Wall Control (included)  Remote Control 3-8-1000-0* (optional)	

*3-8-1000-0 remote features 3 fan speeds, forward/reverse function, light kit on/off/dimmer and timer that will turn off the fan after 2, 4 or 8 hours.

OSLO HUGGER 52" CEILING FAN



3-102-24

shown with optional light kit **3-9-101**

OSLO HUGGER 52" CEILING FAN

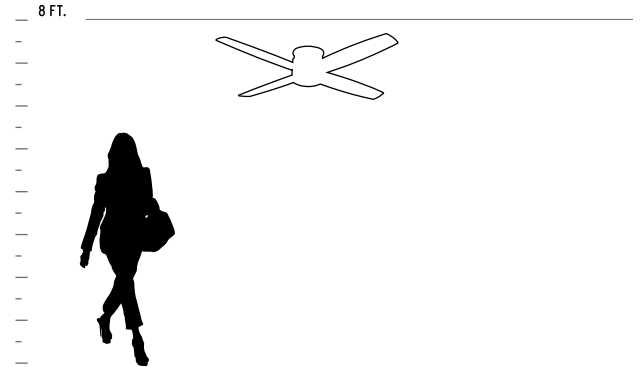

HEIGHT CHART



FAN HEIGHT

- Distance of 10.25"
- Distance of 7"

GENERAL SPECIFICATIONS:

- Lifetime Motor Warranty. • Four Blades. • 52" Blade Sweep.
- 14-Degree Blade Pitch. • 22" Lead Wire.

MECHANICAL SPECIFICATIONS:

- 153x18 Motor. • 3 Speeds-Reversible with wall control. • 14 Poles.
- .54/.28 AMPS on H/L • 64/16 WATTS on H/L • 153/74 RPMS on H/L.
- Wall Control Included. • Remote Control Adaptable w/ 3-8-1000-0 Remote.

ENERGY SPECIFICATIONS:

- Energy Information at High Speed. • Airflow: 3664 Cubic Feet/Minute.
- Electricity Use: 64 Watts (Excludes Lights). • Airflow Efficiency: 57 Cubic Feet/Minute/Watt.

DOE ENERGY GUIDE INFORMAITON

- Airflow 2764 cfm. • Watts 43. • Airflow efficiency 65 cfm/w.
- Estimated yearly energy cost \$12.



AVAILABLE FINISHES



6 White





20 Polished Nickel



22 Oiled Bronze

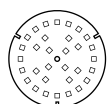

24 Satin Nickel

ITEM #	FINISH	BLADES	LED LIGHT KIT (optional)	CONTROLS		CERTIFICATION
3-102-XX	6 White 20 Polished Nickel 22 Oiled Bronze 24 Satin Nickel	White Silver Oiled Bronze Silver	 3-9-101 17w, 3000k, 90CRI, Dimmable LED w/ Matte White Glass Diffuser	 Wall Control (included)	 Remote Control 3-8-1000-0* (optional)	

*3-8-1000-0 remote features 3 fan speeds, forward/reverse function, light kit on/off/dimmer and timer that will turn off the fan after 2, 4 or 8 hours.

PROPEL 56" CEILING FAN



3-106-22

PROPEL 56" CEILING FAN

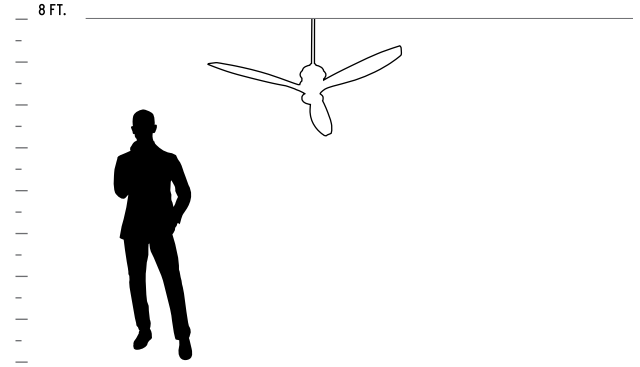

HEIGHT CHART

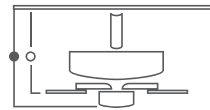

FAN HEIGHT

- Using 4.5" downrod
- Distance of 15.25"
- Distance of 11.5"

GENERAL SPECIFICATIONS:

- Lifetime Motor Warranty. • Three Blades. • 56" Blade Sweep.
- 16-Degree Blade Pitch. • 80" Lead Wire. • 4.5" Downrod (Included)
- Additional Downrod options on page 278.

MECHANICAL SPECIFICATIONS:

- 120mm DC Motor. • 6 Speeds-Reversible with wall control. • 8 Poles.
- .42/.08 AMPS on H/L • 25/3 WATTS on H/L. • 191/75 RPMS on H/L. • Wall Control Included.

ENERGY SPECIFICATIONS:

- Energy Information at High Speed. • Airflow: 5116 Cubic Feet/Minute.
- Electricity Use: 25 Watts (Excludes Lights). • Airflow Efficiency: 204 Cubic Feet/Minute/Watt.

DOE ENERGY GUIDE INFORMAITON

- Airflow 3710 cfm. • Watts 18. • Airflow efficiency 211 cfm/w.
- Estimated yearly energy cost \$5.

AVAILABLE FINISHES





6 White



22 Oiled Bronze

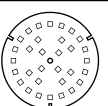

24 Satin Nickel

ITEM #	FINISH	BLADES	LED LIGHT KIT (included)	WALL CONTROL (included)	CERTIFICATION
3-106-XX	6 White 22 Oiled Bronze 24 Satin Nickel	White Oiled Bronze Silver	 15w, 3000k, 90CRI, Dimmable LED w/White Glass Diffuser		

SOL 52" CEILING FAN



3-104-24
shown with optional light kit **3-9-102**

SOL 52" CEILING FAN

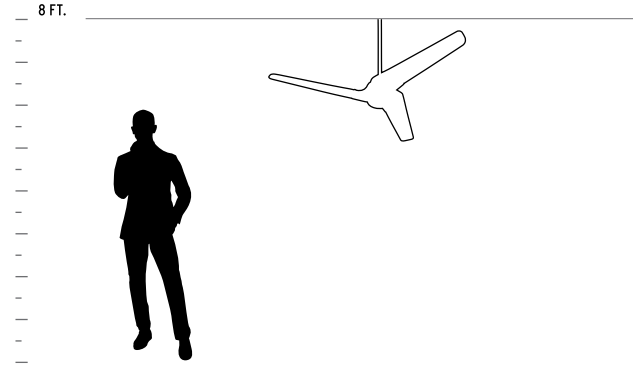

HEIGHT CHART

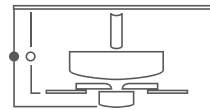

FAN HEIGHT

- Using 4.5" downrod
- Distance of 11.5"
 - Distance of 8"

GENERAL SPECIFICATIONS:

- Lifetime Motor Warranty. • Three Blades. • 52" Blade Sweep.
- 15-Degree Blade Pitch. • 80" Lead Wire. • 4.5" Downrod (Included)
- Additional Downrod options on page 278.

MECHANICAL SPECIFICATIONS:

- 120mm DC Motor. • 3 Speeds-Reversible with wall control. • 8 Poles.
- .39/.07 AMPS on H/L • 23/3 WATTS on H/L. • 168/69 RPMS on H/L.
- Wall Control Included.

ENERGY SPECIFICATIONS:

- Energy Information at High Speed. • Airflow: 4664 Cubic Feet/Minute.
- Electricity Use: 23 Watts (Excludes Lights). • Airflow Efficiency: 202 Cubic Feet/Minute/Watt.

DOE ENERGY GUIDE INFORMAITON

- Airflow 3272 cfm. • Watts 16. • Airflow efficiency 203 cfm/w.
- Estimated yearly energy cost \$5.

AVAILABLE FINISHES



6 White





20 Polished Nickel



22 Oiled Bronze



24 Satin Nickel

ITEM #	FINISH	BLADES	LED LIGHT KIT (optional)	WALL CONTROL (included)	CERTIFICATION
3-104-XX	6 White 20 Polished Nickel 22 Oiled Bronze 24 Satin Nickel	White Silver Oiled Bronze Silver	 3-9-102 15w, 3000k, 90CRI, Dimmable LED w/ Matte White Polycarbonate Diffuser		





sconces

ALCOR SCONCE

ADA

LED



37-532-40

ALCOR SCONCE

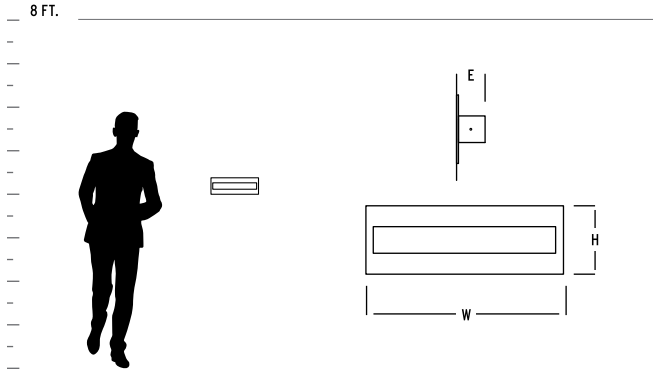

GENERAL SPECIFICATIONS:

- Cold rolled steel backplate and trim.
- Acrylic shade is 1/8", matte white finish.
- Unit mounts to 4"x4" junction box.
- Unit requires 2.5" deep junction box.
- Driver mounts inside junction box.
- Total luminaire power 15.2w.
- Visit www.oxygenlighting.com for technical cut sheets.
- Oxygen reserves the right to modify designs at any time.



3-532-24

AVAILABLE FINISHES









22 Oiled Bronze



24 Satin Nickel



40 Aged Brass

ITEM #	DIFFUSER	FINISH	DIMENSIONS	LAMPING	DRIVER	CERTIFICATION
3-532-XX	Matte White Acrylic	22 Oiled Bronze 24 Satin Nickel 40 Aged Brass	13"(w) x 4.5"(h) x 2"(ext)	1 x 11.9w, 90CRI 3000k LED	120V 0-10V/Phase dimming	  
37-532-XX	Matte White Acrylic	22 Oiled Bronze 24 Satin Nickel 40 Aged Brass	13"(w) x 4.5"(h) x 2"(ext)	1 x 11.9w, 90CRI 3000k LED	277V 0-10V/Phase dimming	  

2700k, 3500k, 4000k color temperatures also available. Contact Oxygen for ordering information.

APOLLO SCNCE

ADA

LED

FLOURESCENT

ENERGY STAR



2-5107-24

APOLLO SCONCE



3-570-24

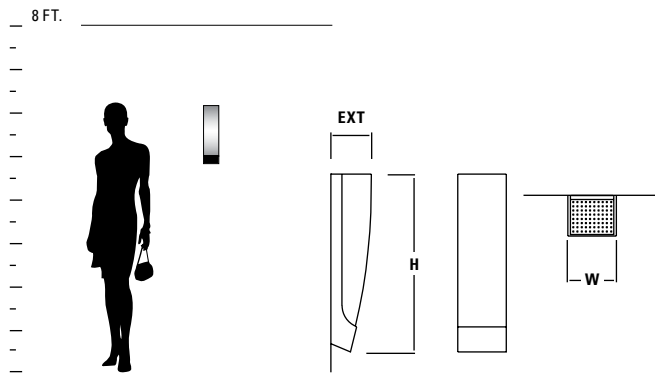

GENERAL SPECIFICATIONS:

- Cold-rolled steel housing. • Perforated metal top lens. • Diffuser is 1/8" thick matte white acrylic. • Unit mounts to 2"x3" or 4" octagonal junction box. • Toolless access to lamps for 2-5107-24. • Approved for wall mount application only. • Total luminaire power 13.1w for LED models. • Visit www.oxygenlighting.com for technical cut sheets. • Oxygen reserves the right to modify designs at any time.

AVAILABLE FINISH



24 Satin Nickel

ITEM #	DIFFUSER	FINISH	DIMENSIONS	LAMPING	BALLAST	DRIVER	CERTIFICATION
2-5107-24	Matte White Acrylic	24 Satin Nickel	4.5"(w) x 16"(h) x 3.75"(ext)	1 x 24w twin 4-pin fluorescent (2G11)	Electronic, HPF, Programmed Start, Universal Voltage (120-277V)	--	
3-570-24	Matte White Acrylic	24 Satin Nickel	4.5"(w) x 16"(h) x 3.75"(ext)	1 x 10.1w, 90CRI 3000k LED	--	120V 0-10V/Phase dimming	
37-570-24	Matte White Acrylic	24 Satin Nickel	4.5"(w) x 16"(h) x 3.75"(ext)	1 x 10.1w, 90CRI 3000k LED	--	277V 0-10V/Phase dimming	

2700k, 3500k, 4000k color temperatures also available for LED models. Contact Oxygen for ordering information.

BEACON SCONCE

ADA

LED

FLOURESCENT



3-587-224

BEACON SCONCE



2-597-295

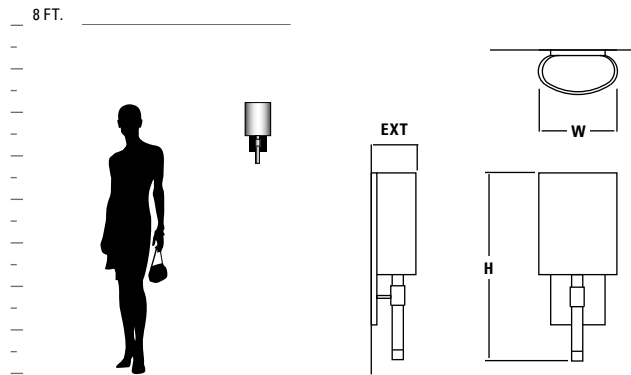

GENERAL SPECIFICATIONS:

- Cold rolled steel backplate and trim.
- Clear, polished resin accent.
- Fabric shade is white cotton.
- Acrylic shade is 1/8", matte white finish.
- White acrylic top and bottom lenses.
- Unit mounts to 4" octagonal junction box.
- Toolless access to lamps for fluorescent models.
- Total luminaire power 10.4w for LED models.
- Visit www.oxygenlighting.com for technical cut sheets.
- Oxygen reserves the right to modify designs at any time.

AVAILABLE FINISHES



24 Satin Nickel



95 Old World

ITEM #	DIFFUSER	FINISH	DIMENSIONS	LAMPING	BALLAST	DRIVER	CERTIFICATION
2-597-XXX	1 White Cotton 2 Matte White Acrylic	24 Satin Nickel 95 Old World	7"(w) x 16.5"(h) x 3.75"(ext)	1 x 26w quad 4-pin fluorescent (G24q-3)	Electronic, HPF, Programmed Start, Universal Voltage (120-277V)	-	ADA COMPLIANT c UL US damp
3-587-XXX	1 White Cotton 2 Matte White Acrylic	24 Satin Nickel 95 Old World	7"(w) x 16.5"(h) x 3.75"(ext)	1 x 8.2w, 90CRI 3000k LED	-	120V 0-10V/Phase dimming	ADA COMPLIANT c ETL US damp
37-587-XXX	1 White Cotton 2 Matte White Acrylic	24 Satin Nickel 95 Old World	7"(w) x 16.5"(h) x 3.75"(ext)	1 x 8.2w, 90CRI 3000k LED	-	277V 0-10V/Phase dimming	ADA COMPLIANT c ETL US damp

2700k, 3500k, 4000k color temperatures also available for LED models. Contact Oxygen for ordering information.

CHAMELEON SCONCE

ADA

FLOURESCENT



2-5145-124

CHAMELEON SCONCE

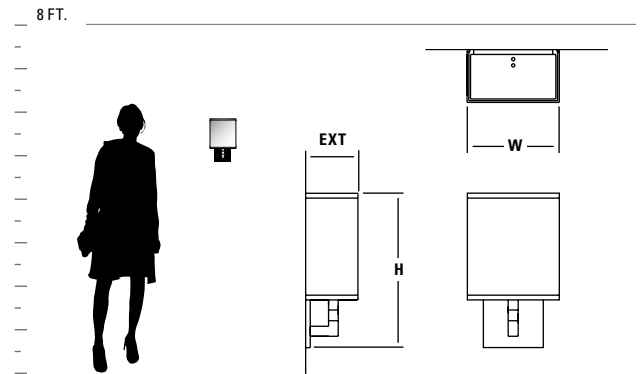

GENERAL SPECIFICATIONS:

- Cold rolled steel housing. • Frost resin accents. • Acrylic lenses and shades are 1/8" thick matte white. • Fabric shade is white cotton. • White grass shade is natural bamboo fibers. • White acrylic top and bottom lenses. • All units mount to 4" octagonal junction box. • Toolless access to lamps. • Visit www.oxygenlighting.com for technical cut sheets. • Oxygen reserves the right to modify designs at any time.

AVAILABLE FINISH



ITEM #	DIFFUSER	FINISH	DIMENSIONS	LAMPING	BALLAST	CERTIFICATION
2-5145-XXX	1 White Cotton 2 Matte White Acrylic 5 White Grass	24 Satin Nickel	8"(w) x 11.75"(h) x 4"(ext)	1 x 26w quad 4-pin fluorescent (G24q-3)	Electronic, HPF, Programmed Start, Universal Voltage (120-277V)	

CHAMELEON SCONCE

ADA

FLOURESCENT



2-5146-224

CHAMELEON SCONCE

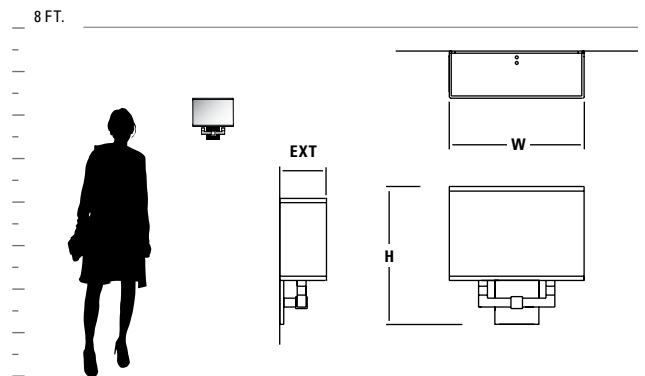

GENERAL SPECIFICATIONS:

- Cold rolled steel housing.
- Frost resin accents.
- Acrylic lenses and shades are 1/8" thick matte white.
- Fabric shade is white cotton.
- White acrylic top and bottom lenses.
- All units mount to 4" octagonal junction box.
- Toolless access to lamps.
- Visit www.oxygenlighting.com for technical cut sheets.
- Oxygen reserves the right to modify designs at any time.

AVAILABLE FINISH



24 Satin Nickel

ITEM #	DIFFUSER	FINISH	DIMENSIONS	LAMPING	BALLAST	CERTIFICATION
2-5146-XXX	1 White Cotton 2 Matte White Acrylic	24 Satin Nickel	11.75"(w) x 11.5"(h) x 4"(ext)	2 x 13w quad 4-pin fluorescent (G24q-1)	Electronic, HPF, Programmed Start, Universal Voltage (120-277V)	

CHAMELEON SCONCE

ADA

LED



3-521-40

CHAMELEON SCONCE

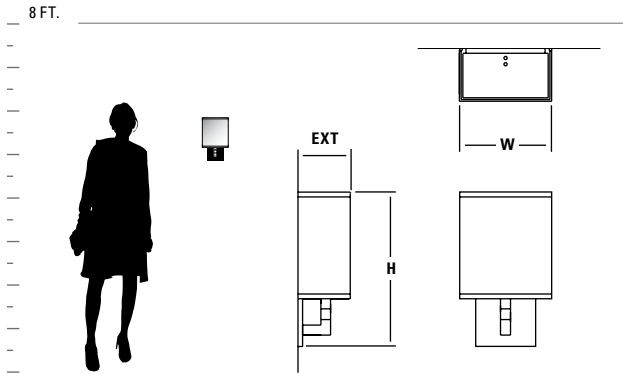

GENERAL SPECIFICATIONS:

- Cold rolled steel housing.
- Frost resin accent.
- Matte white acrylic lenses and shades are 1/8" thick.
- Unit mounts to 4" octagonal junction box.
- Total luminaire power 10.4w.
- Visit www.oxygenlighting.com for technical cut sheets.
- Oxygen reserves the right to modify designs at any time.



AVAILABLE FINISHES

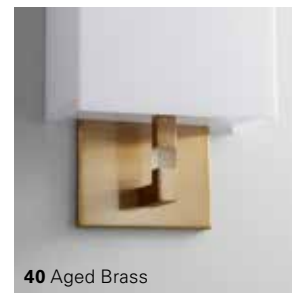

ITEM #	DIFFUSER	FINISH	DIMENSIONS	LAMPING	DRIVER	CERTIFICATION
3-521-XX	Matte White Acrylic	14 Polished Chrome 22 Oiled Bronze 24 Satin Nickel 40 Aged Brass	8"(w) x 11.75"(h) x 4"(ext)	1 x 8.2w, 90CRI 3000k LED	120V 0-10V/Phase dimming.	
37-521-XX	Matte White Acrylic	14 Polished Chrome 22 Oiled Bronze 24 Satin Nickel 40 Aged Brass	8"(w) x 11.75"(h) x 4"(ext)	1 x 8.2w, 90CRI 3000k LED	277V 0-10V/Phase dimming.	

2700k, 3500k, 4000k color temperatures also available. Contact Oxygen for ordering information.

CHAMELEON SCONCE

ADA

LED



3-514-40

CHAMELEON SCONCE

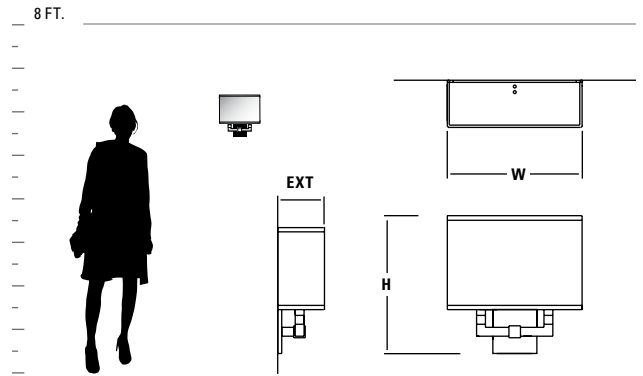

GENERAL SPECIFICATIONS:

- Cold rolled steel housing. • Frost resin accent. • Matte white acrylic lenses and shades are 1/8" thick. • Unit mounts to 4" octagonal junction box. • Total luminaire power 13.1w. • Visit www.oxygenlighting.com for technical cut sheets. • Oxygen reserves the right to modify designs at any time.

AVAILABLE FINISHES

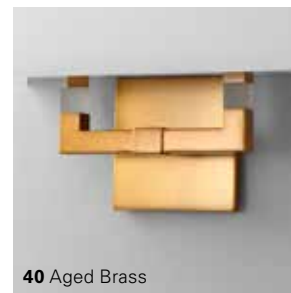

ITEM #	DIFFUSER	FINISH	DIMENSIONS	LAMPING	DRIVER	CERTIFICATION
3-514-XX	Matte White Acrylic	14 Polished Chrome 22 Oiled Bronze 24 Satin Nickel 40 Aged Brass	11.75"(w) x 11.5"(h) x 4"(ext)	2 x 10.1w, 90CRI 3000k LED	120V 0-10V/Phase dimming.	
37-514-XX	Matte White Acrylic	14 Polished Chrome 22 Oiled Bronze 24 Satin Nickel 40 Aged Brass	11.75"(w) x 11.5"(h) x 4"(ext)	2 x 10.1w, 90CRI 3000k LED	277V 0-10V/Phase dimming.	

2700k, 3500k, 4000k color temperatures also available. Contact Oxygen for ordering information.

CORNETA SCONCE

ADA

INCANDESCENT

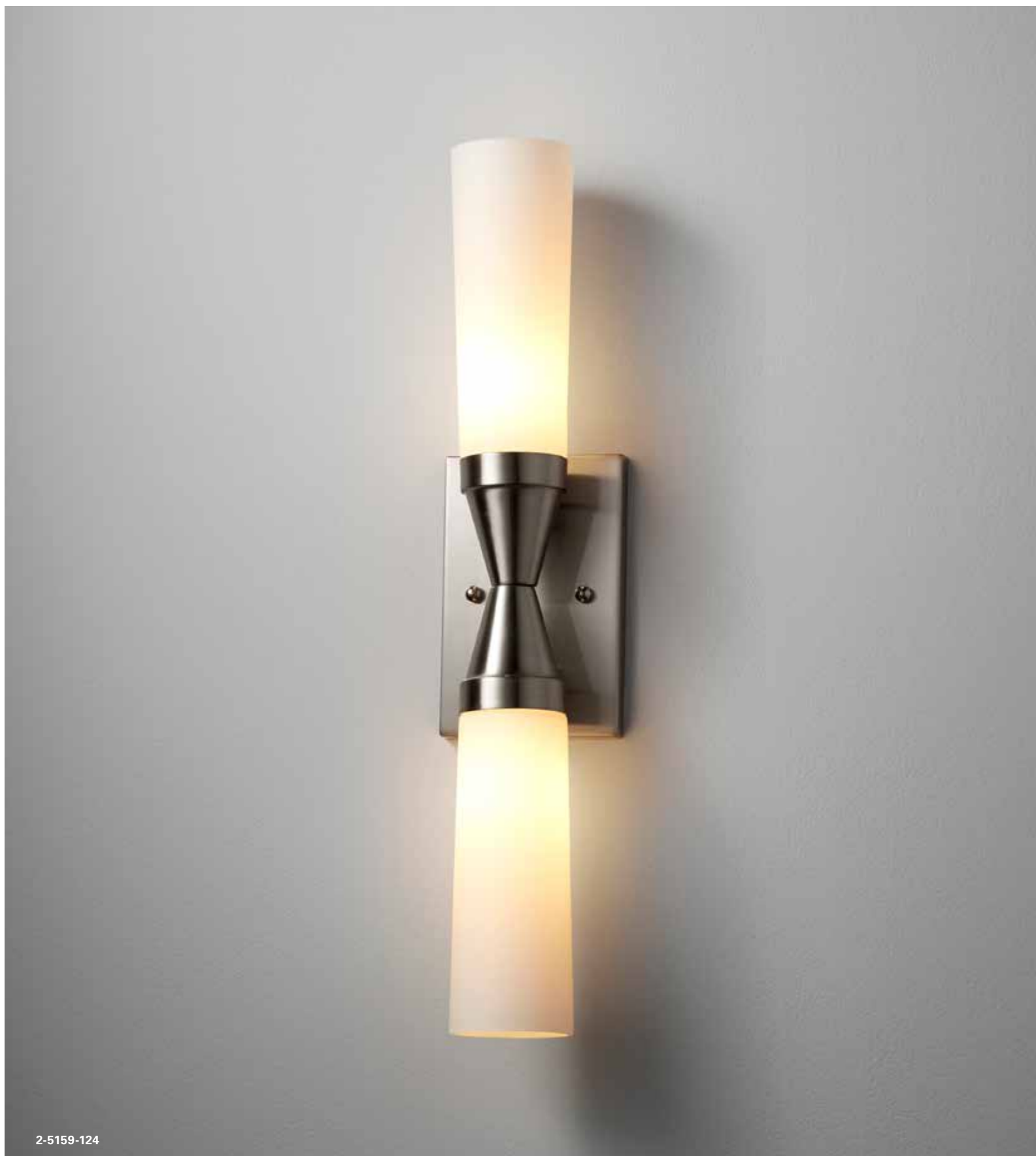

2-5159-124

CORNETA SCONCE



2-5159-124

GENERAL SPECIFICATIONS:

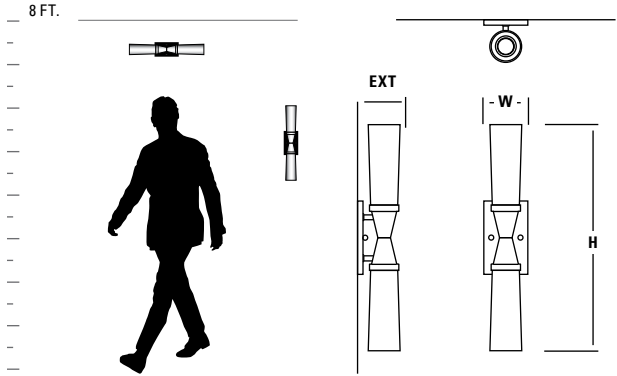

- Spun steel housing.
- Cold rolled steel backplate.
- Diffuser threads onto housing with integral threaded fitting.
- Diffuser is 1/8" white opal duplex glass.
- Mounts to 4" octagonal junction box.
- Toolless access to lamps.
- Approved for vertical or horizontal mounting.
- Visit www.oxygenlighting.com for technical cut sheets.
- Oxygen reserves the right to modify designs at any time.



AVAILABLE FINISH



24 Satin Nickel

ITEM #	DIFFUSER	FINISH	DIMENSIONS	LAMPING	CERTIFICATION
2-5159-124	White Opal Glass	24 Satin Nickel	4"(w) x 21.25"(h) x 4"(ext)	2 x 60w 120V incandescent (medium base lamps not included)	  

CRESCENT SCONCE

ADA

LED



3-513-14

3-512-14

CRESCENT SCONCE

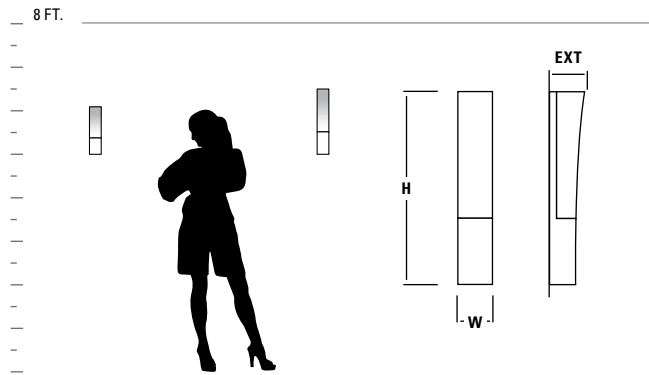













GENERAL SPECIFICATIONS:

- Cold rolled steel housing.
- Diffusers are 1/8" thick matte white acrylic.
- Units mount to 2"x3" junction box.
- Approved for vertical mounting.
- Approved for wall mount applications only.
- Total luminaire power 12.9w for 3-512-XX/37-512-XX and 12.8w for 3-513-XX/37-513-XX.
- Visit www.oxygenlighting.com for technical cut sheets.
- Oxygen reserves the right to modify designs at any time.

AVAILABLE FINISHES



ITEM #	DIFFUSER	FINISH	DIMENSIONS	LAMPING	DRIVER	CERTIFICATION
3-512-XX small	Matte White Acrylic	14 Polished Chrome 24 Satin Nickel 25 Satin Copper	3.5"(w) x 14"(h) x 3.75"(ext)	1 x 10.1w, 90CRI 3000k LED	120V 0-10V/Phase dimming	  
37-512-XX small	Matte White Acrylic	14 Polished Chrome 24 Satin Nickel 25 Satin Copper	3.5"(w) x 14"(h) x 3.75"(ext)	1 x 10.1w, 90CRI 3000k LED	277V 0-10V/Phase dimming	  
3-513-XX large	Matte White Acrylic	14 Polished Chrome 24 Satin Nickel 25 Satin Copper	3.5"(w) x 18.75"(h) x 3.75"(ext)	1 x 10.1w, 90CRI 3000k LED	120V 0-10V/Phase dimming	  
37-513-XX large	Matte White Acrylic	14 Polished Chrome 24 Satin Nickel 25 Satin Copper	3.5"(w) x 18.75"(h) x 3.75"(ext)	1 x 10.1w, 90CRI 3000k LED	277V 0-10V/Phase dimming	  

2700k, 3500k, 4000k color temperatures also available. Contact Oxygen for ordering information.

DUO SCONCE

ADA

LED



3-509-24

DUO SCONCE

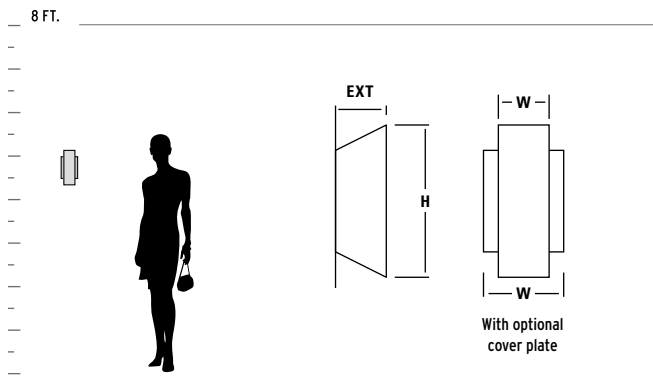

GENERAL SPECIFICATIONS:

- Cold rolled steel housing. • Frosted glass diffusers. • Unit mounts to 2"x3" junction box. • Supplied with 4.75"x6" cover plate for mounting to 4" octagonal junction box. • Approved for vertical mounting.
- Approved for wall mount applications only. • Visit www.oxygenlighting.com for technical cut sheets.
- Oxygen reserves the right to modify designs at any time.

AVAILABLE FINISHES



ITEM #	DIFFUSER	FINISH	DIMENSIONS	LAMPING	CERTIFICATION
3-509-XX	Frosted Glass	14 Polished Chrome 18 Gunmetal 24 Satin Nickel 25 Satin Copper 40 Aged Brass	3"(w) x 9.25"(h) x 3"(ext) w/o optional cover plate	2 x 7w MAX GU10 120V LED ONLY (lamps not included)	

ELEMENTS SCONCE

ADA

LED



3-5120-14
Matte Opal Cylinder Glass

ELEMENTS SCONCE

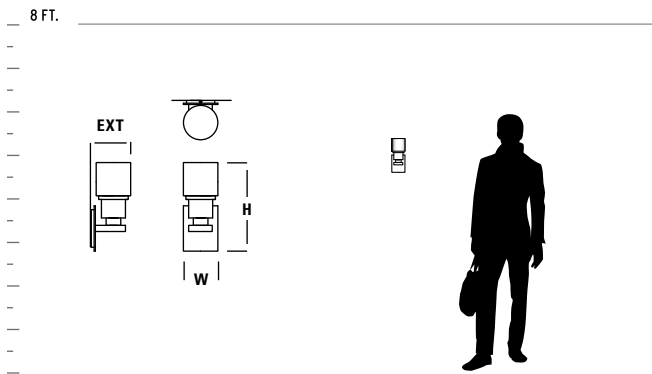

GENERAL SPECIFICATIONS:

- Cold rolled steel housing.
- Diffusers are 1/8" thick matte opal glass.
- Diffuser screws onto housing with integral threaded fitting.
- Unit mounts to 2"x3" junction box.
- Approved for vertical mounting.
- Approved for wall mount applications only.
- Visit www.oxygenlighting.com for technical cut sheets.
- Oxygen reserves the right to modify designs at any time.



3-5110-24
Matte Opal Cube Glass

AVAILABLE FINISHES



14 Polished Chrome



24 Satin Nickel

ITEM #	DIFFUSER	FINISH	DIMENSIONS	LAMPING	CERTIFICATION
3-5110-XX	Matte Opal Cube Glass	14 Polished Chrome 24 Satin Nickel	3.625"(w) x 8.25"(h) x 4"(ext)	1 x 7w MAX GU10 120V LED ONLY (lamp not included)	
3-5120-XX	Matte Opal Cylinder Glass	14 Polished Chrome 24 Satin Nickel	3.625"(w) x 8.25"(h) x 4"(ext)	1 x 7w MAX GU10 120V LED ONLY (lamp not included)	

EPOCH SCONCE

ADA

LED

FLOURESCENT



3-564-240

EPOCH SCONCE

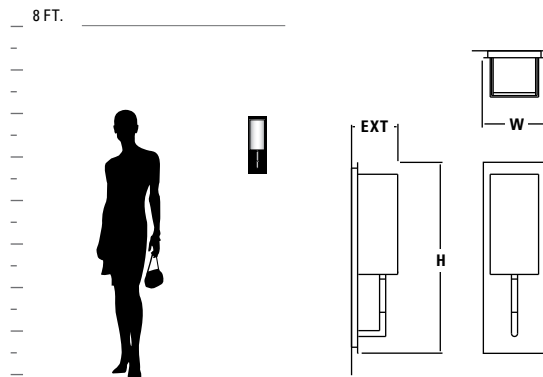

GENERAL SPECIFICATIONS:

- Cold rolled steel backplate. • Steel tubing with frost resin accent. • Fabric shade is white cotton.
- Acrylic shade is 1/8", matte white finish. • White acrylic top and bottom lenses. • Mounts to 4" octagonal junction box. • Toolless access to lamps for fluorescent models. • Total luminaire power 10.4w for LED models. • Visit www.oxygenlighting.com for technical cut sheets. • Oxygen reserves the right to modify designs at any time.

AVAILABLE FINISHES

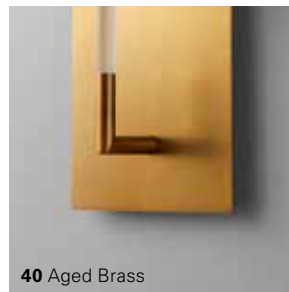

ITEM #	DIFFUSER	FINISH	DIMENSIONS	LAMPING	BALLAST	DRIVER	CERTIFICATION
2-5154-XXX	1 White Cotton 2 Matte White Acrylic	24 Satin Nickel	5.25"(w) x 15.75"(h) x 3.75"(ext)	1 x 18w quad 4-pin fluorescent (G24q-2)	Electronic, HPF, Programmed Start, Universal Voltage (120-277V)	--	ADA COMPLIANT UL damp c UL us
3-564-XXX	1 White Cotton 2 Matte White Acrylic	22 Oiled Bronze 24 Satin Nickel 40 Aged Brass	5.25"(w) x 15.75"(h) x 3.75"(ext)	1 x 8.2w, 90CRI 3000k LED	--	120V 0-10V/Phase dimming.	ADA COMPLIANT ETL us ETL damp
37-564-XXX	1 White Cotton 2 Matte White Acrylic	22 Oiled Bronze 24 Satin Nickel 40 Aged Brass	5.25"(w) x 15.75"(h) x 3.75"(ext)	1 x 8.2w, 90CRI 3000k LED	--	277V 0-10V/Phase dimming.	ADA COMPLIANT ETL us ETL damp

2700k, 3500k, 4000k color temperatures also available for LED models. Contact Oxygen for ordering information.

HALO SCONCE

ADA

LED



3-515-25

HALO SCONCE

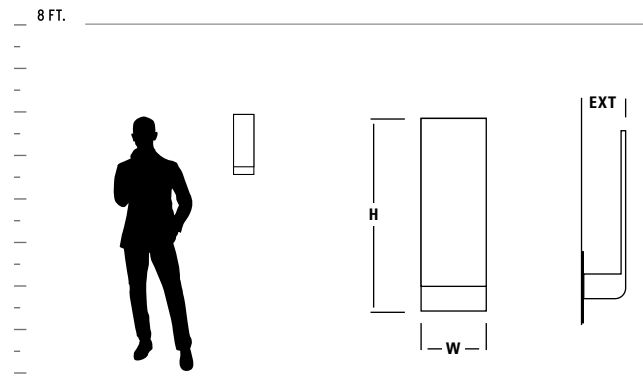

GENERAL SPECIFICATIONS:

- Cold rolled steel housing. • Matte white acrylic diffuser.
- Unit mounts to 4" octagonal junction box. • Approved for vertical mounting. • Approved for wall mount applications only. • Total luminaire power 13w. • Visit www.oxygenlighting.com for technical cut sheets. • Oxygen reserves the right to modify designs at any time.

AVAILABLE FINISHES



ITEM #	DIFFUSER	FINISH	DIMENSIONS	LAMPING	DRIVER	CERTIFICATION
3-515-XX	Matte White Acrylic	14 Polished Chrome 24 Satin Nickel 25 Satin Copper 40 Aged Brass	5.5"(w) x 18"(h) x 3.25"(ext)	1 x 10.1w, 90CRI 3000k LED	120V 0-10V/Phase dimming	ADA COMPATIBLE ETL US ETL damp
37-515-XX	Matte White Acrylic	14 Polished Chrome 24 Satin Nickel 25 Satin Copper 40 Aged Brass	5.5"(w) x 18"(h) x 3.25"(ext)	1 x 10.1w, 90CRI 3000k LED	277V 0-10V/Phase dimming	ADA COMPATIBLE ETL US ETL damp
3-535-XX small	Matte White Acrylic	14 Polished Chrome 24 Satin Nickel 25 Satin Copper 40 Aged Brass	5.5"(w) x 12.625"(h) x 3.25"(ext)	1 x 10.1w, 90CRI 3000k LED	120V 0-10V/Phase dimming	ADA COMPATIBLE ETL US ETL damp
37-535-XX small	Matte White Acrylic	14 Polished Chrome 24 Satin Nickel 25 Satin Copper 40 Aged Brass	5.5"(w) x 12.625"(h) x 3.25"(ext)	1 x 10.1w, 90CRI 3000k LED	277V 0-10V/Phase dimming	ADA COMPATIBLE ETL US ETL damp

2700k, 3500k, 4000k color temperatures also available. Contact Oxygen for ordering information.

ICON SCONCE

ADA

LED



3-511-24

Shown With Optional Cover Plate (Included)

ICON SCONCE



3-511-22

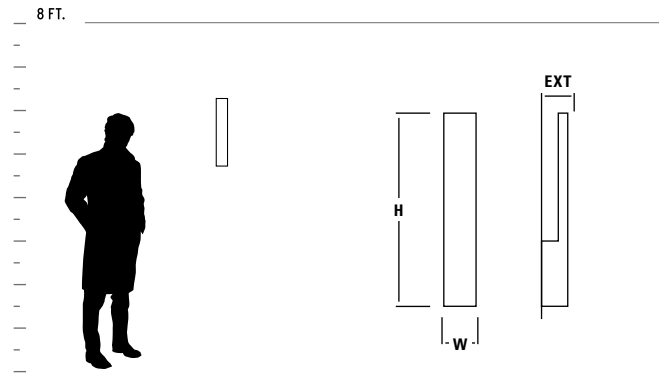

GENERAL SPECIFICATIONS:

- Cold rolled steel housing. • Matte white acrylic diffuser. • Unit mounts to 2"x3" junction box.
- Supplied with 4.75"x6" cover plate for mounting to 4" octagonal junction box. • Approved for vertical mounting. • Approved for wall mount applications only. • Total luminaire power 12.8w. • Visit www.oxygenlighting.com for technical cut sheets. • Oxygen reserves the right to modify designs at any time.

AVAILABLE FINISHES



14 Polished Chrome



22 Oiled Bronze



24 Satin Nickel



25 Satin Copper



40 Aged Brass

ITEM #	DIFFUSER	FINISH	DIMENSIONS	LAMPING	DRIVER	CERTIFICATION
3-511-XX	Matte White Acrylic	14 Polished Chrome 22 Oiled Bronze 24 Satin Nickel 25 Satin Copper 40 Aged Brass	3.25"(w) x 19.5"(h) x 2.5"(ext) w/o optional cover plate	1 x 10.1w, 90CRI 3000k LED	120V 0-10V/Phase dimming	
37-511-XX	Matte White Acrylic	14 Polished Chrome 22 Oiled Bronze 24 Satin Nickel 25 Satin Copper 40 Aged Brass	3.25"(w) x 19.5"(h) x 2.5"(ext) w/o optional cover plate	1 x 10.1w, 90CRI 3000k LED	277V 0-10V/Phase dimming	

2700k, 3500k, 4000k color temperatures also available. Contact Oxygen for ordering information.

KIKO SCONCE

ADA

LED



3-345-24

KIKO SCONCE

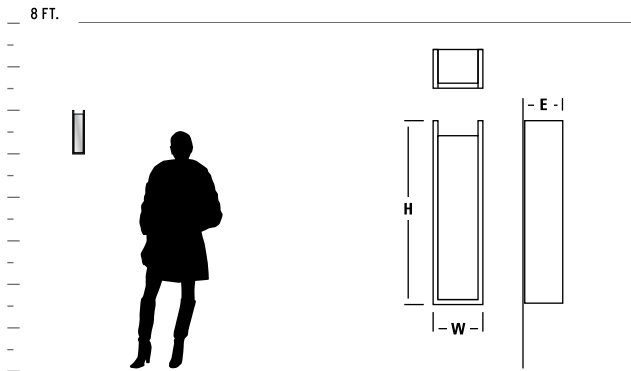

GENERAL SPECIFICATIONS:

- Cold-rolled steel housing.
- Diffuser is 1/8" thick matte white acrylic.
- Unit mounts to 2"x3" junction box.
- Approved for wall mount application only.
- Total luminaire power 12.8w.
- Visit www.oxygenlighting.com for technical cut sheets.
- Oxygen reserves the right to modify designs at any time.



AVAILABLE FINISHES



ITEM #	DIFFUSER	FINISH	DIMENSIONS	LAMPING	DRIVER	CERTIFICATION
3-545-XX	Matte White Acrylic	20 Polished Nickel 24 Satin Nickel	3.25"(w) x 12"(h) x 2.5"(ext)	1 x 10.1w, 90CRI 3000k LED	120V 0-10V/Phase dimming	
37-545-XX	Matte White Acrylic	20 Polished Nickel 24 Satin Nickel	3.25"(w) x 12"(h) x 2.5"(ext)	1 x 10.1w, 90CRI 3000k LED	277V 0-10V/Phase dimming	

2700k, 3500k, 4000k color temperatures also available. Contact Oxygen for ordering information.

MAGNETA SCONCE

ADA

LED

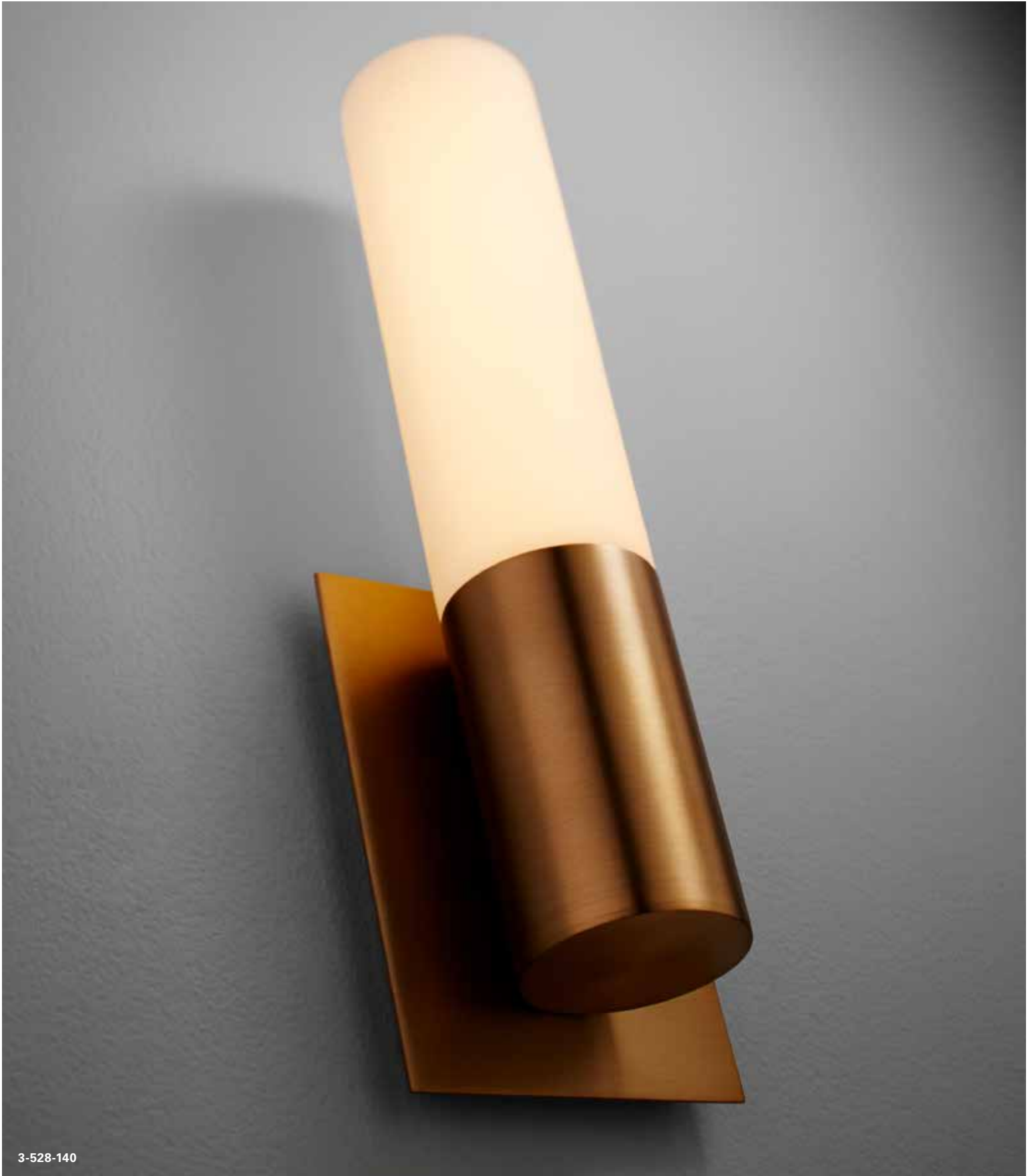

3-528-140

MAGNETA SCNCE

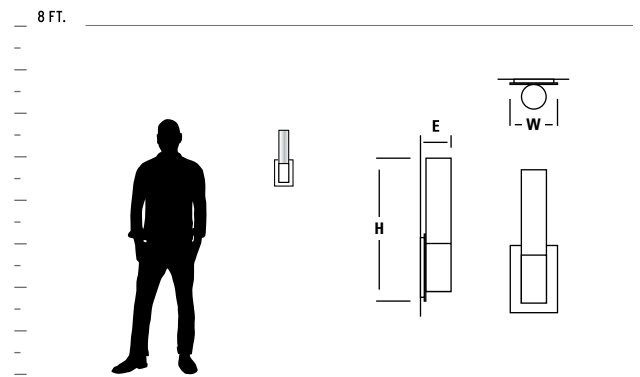

GENERAL SPECIFICATIONS:

- Cold-rolled steel housing.
- Closed top diffuser is 1/8" thick matte white acrylic or matte opal glass.
- Diffuser screws onto housing with integral threaded fitting.
- Unit mounts to 4" octagonal junction box.
- Approved for wall mount application only.
- Total luminaire power 15.2w.
- Visit www.oxygenlighting.com for technical cut sheets.
- Oxygen reserves the right to modify designs at any time.

AVAILABLE FINISHES



ITEM #	DIFFUSER	FINISH	DIMENSIONS	LAMPING	DRIVER	CERTIFICATION
3-528-XX	Matte White Acrylic	14 Polished Chrome 24 Satin Nickel 40 Aged Brass	4.75"(w) x 14.375"(h) x 3.25"(ext)	1 x 11.9w, 90CRI 3000k LED	120V 0-10V/Phase dimming	ADA COMPLIANT, ETL US, ETL damp
37-528-XX	Matte White Acrylic	14 Polished Chrome 24 Satin Nickel 40 Aged Brass	4.75"(w) x 14.375"(h) x 3.25"(ext)	1 x 11.9w, 90CRI 3000k LED	277V 0-10V/Phase dimming	ADA COMPLIANT, ETL US, ETL damp
3-528-1XX	1 Matte Opal Glass	14 Polished Chrome 24 Satin Nickel 40 Aged Brass	4.75"(w) x 14.375"(h) x 3.25"(ext)	1 x 11.9w, 90CRI 3000k LED	120V 0-10V/Phase dimming	ADA COMPLIANT, ETL US, ETL damp
37-528-1XX	1 Matte Opal Glass	14 Polished Chrome 24 Satin Nickel 40 Aged Brass	4.75"(w) x 14.375"(h) x 3.25"(ext)	1 x 11.9w, 90CRI 3000k LED	277V 0-10V/Phase dimming	ADA COMPLIANT, ETL US, ETL damp

2700k, 3500k, 4000k color temperatures also available. Contact Oxygen for ordering information.

MAGNUM SCONCE

ADA

LED



3-518-14

MAGNUM SCONCE

8 FT.

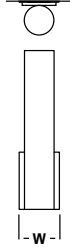
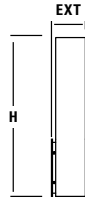

GENERAL SPECIFICATIONS:

- Cold-rolled steel housing.
- Closed top diffuser is 1/8" thick matte white acrylic or matte opal glass.
- Diffuser screws onto housing with integral threaded fitting.
- Unit mounts to 4" octagonal junction box.
- Approved for wall mount application only.
- Total luminaire power 15.1w.
- Visit www.oxygenlighting.com for technical cut sheets.
- Oxygen reserves the right to modify designs at any time.



AVAILABLE FINISHES



ITEM #	DIFFUSER	FINISH	DIMENSIONS	LAMPING	DRIVER	CERTIFICATION
3-518-XX	Matte White Acrylic	14 Polished Chrome 24 Satin Nickel 25 Satin Copper 40 Aged Brass	4.75"(w) x 18.75"(h) x 4"(ext)	1 x 11.9w, 90CRI 3000k LED	120V 0-10V/Phase dimming	ADA COMPLIANT, ETL, ETL damp
37-518-XX	Matte White Acrylic	14 Polished Chrome 24 Satin Nickel 25 Satin Copper 40 Aged Brass	4.75"(w) x 18.75"(h) x 4"(ext)	1 x 11.9w, 90CRI 3000k LED	277V 0-10V/Phase dimming	ADA COMPLIANT, ETL, ETL damp
3-518-1XX	1 Matte Opal Glass	14 Polished Chrome 24 Satin Nickel 25 Satin Copper 40 Aged Brass	4.75"(w) x 18.75"(h) x 4"(ext)	1 x 11.9w, 90CRI 3000k LED	120V 0-10V/Phase dimming	ADA COMPLIANT, ETL, ETL damp
37-518-1XX	1 Matte Opal Glass	14 Polished Chrome 24 Satin Nickel 25 Satin Copper 40 Aged Brass	4.75"(w) x 18.75"(h) x 4"(ext)	1 x 11.9w, 90CRI 3000k LED	277V 0-10V/Phase dimming	ADA COMPLIANT, ETL, ETL damp

2700k, 3500k, 4000k color temperatures also available. Contact Oxygen for ordering information.

METRIX SCONCE

ADA

LED



3-541-20

METRIX SCONCE

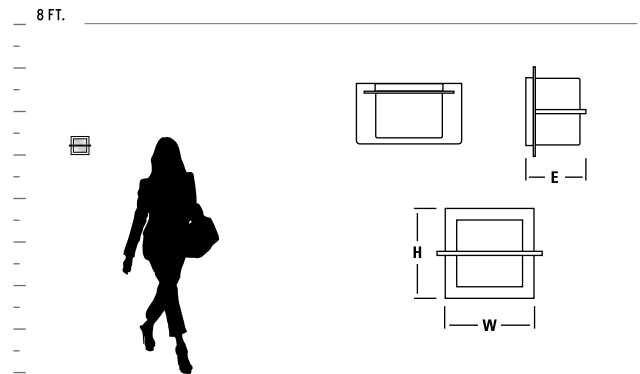

GENERAL SPECIFICATIONS:

- Cold-rolled steel housing. • Diffuser is 1/8" thick matte white acrylic.
- Unit mounts to 2"x3" or 4" octagonal junction box. • Driver mounts inside junction box. • Unit requires 2.5" deep junction box. • Approved for wall and ceiling mount applications. • Total luminaire power 10.5w. • Visit www.oxygenlighting.com for technical cut sheets. • Oxygen reserves the right to modify designs at any time.

AVAILABLE FINISHES



ITEM #	DIFFUSER	FINISH	DIMENSIONS	LAMPING	DRIVER	CERTIFICATION
3-541-XX	Matte White Acrylic	20 Polished Nickel 24 Satin Nickel	5.75"(w) x 5.75"(h) x 3.875"(ext)	1 x 8.2w, 90CRI 3000k LED	120V 0-10V/Phase dimming	
37-541-XX	Matte White Acrylic	20 Polished Nickel 24 Satin Nickel	5.75"(w) x 5.75"(h) x 3.875"(ext)	1 x 8.2w, 90CRI 3000k LED	277V 0-10V/Phase dimming	

2700k, 3500k, 4000k color temperatures also available. Contact Oxygen for ordering information.

MIES SCONCE

ADA

LED

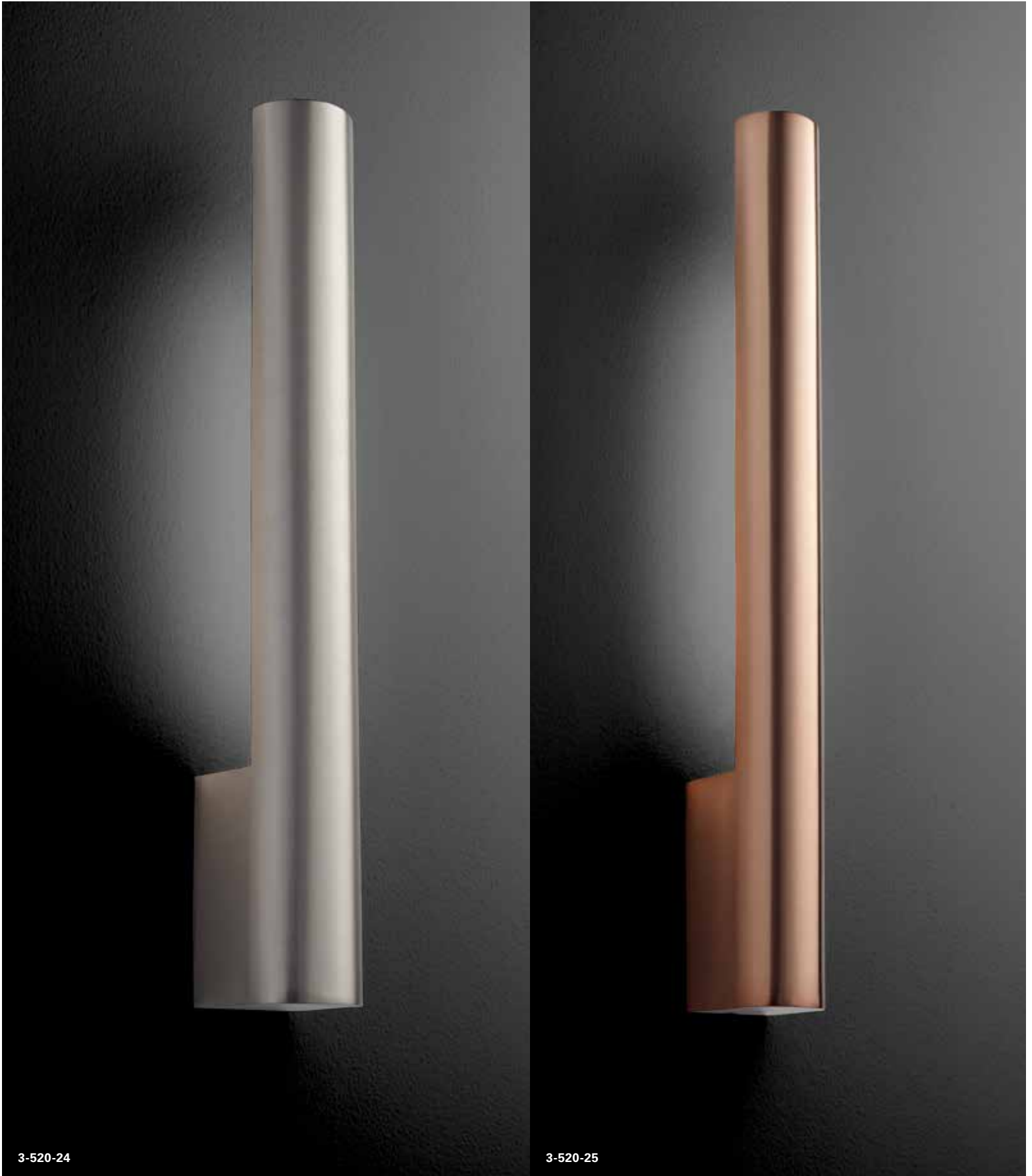

MIES SCONCE



3-520-14
Shown with optional cover plate
(included)



3-520-40
Shown with optional cover plate
(included)

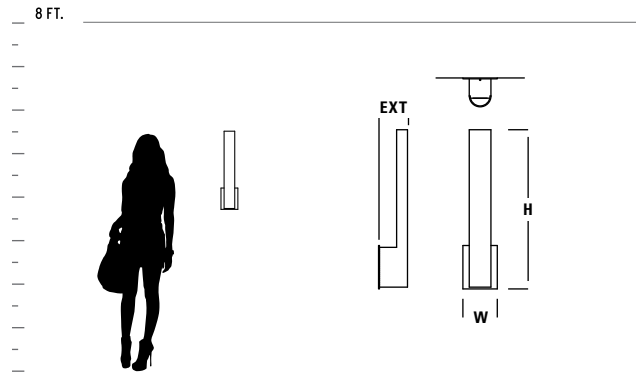

GENERAL SPECIFICATIONS:

- Cold rolled steel housing.
- Matte white acrylic diffuser.
- Unit mounts to 2"x3" junction box.
- Supplied with 4.75"x6" cover plate for mounting to 4" octagonal junction box.
- Approved for vertical mounting.
- Approved for wall mount applications only.
- Total luminaire power 12.7w.
- Visit www.oxygenlighting.com for technical cut sheets.
- Oxygen reserves the right to modify designs at any time.

AVAILABLE FINISHES



14 Polished Chrome







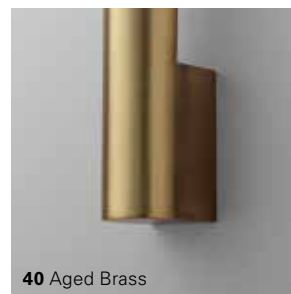

24 Satin Nickel



25 Satin Copper



40 Aged Brass

ITEM #	DIFFUSER	FINISH	DIMENSIONS	LAMPING	DRIVER	CERTIFICATION
3-520-XX	Matte White Acrylic	14 Polished Chrome 24 Satin Nickel 25 Satin Copper 40 Aged Brass	3"(w) x 21.75"(h) x 4"(ext) w/o optional cover plate	1 x 10.1w, 90CRI 3000k LED	120V 0-10V/Phase dimming	  
37-520-XX	Matte White Acrylic	14 Polished Chrome 24 Satin Nickel 25 Satin Copper 40 Aged Brass	3"(w) x 21.75"(h) x 4"(ext) w/o optional cover plate	1 x 10.1w, 90CRI 3000k LED	277V 0-10V/Phase dimming	  

2700k, 3500k, 4000k color temperatures also available. Contact Oxygen for ordering information.

MIRAGE SCONCE

ADA

LED



3-516-24

MIRAGE SCONCE

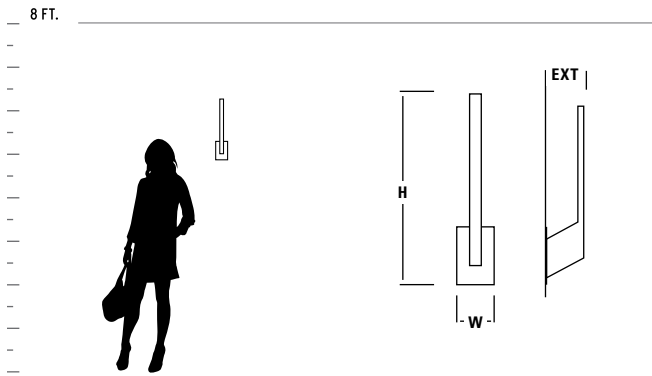

GENERAL SPECIFICATIONS:

- Cold rolled steel housing. • Matte white acrylic diffuser. • Unit mounts to 2"x3" or 4" octagonal junction box. • Approved for vertical mounting. • Approved for wall mount applications only. • Total luminaire power 15w. • Visit www.oxygenlighting.com for technical cut sheets. • Oxygen reserves the right to modify designs at any time.



3-516-40

AVAILABLE FINISHES



14 Polished Chrome



24 Satin Nickel



25 Satin Cooper



40 Aged Brass

ITEM #	DIFFUSER	FINISH	DIMENSIONS	LAMPING	DRIVER	CERTIFICATION
3-516-XX	Matte White Acrylic	14 Polished Chrome 24 Satin Nickel 25 Satin Copper 40 Aged Brass	4.75"(w) x 19.125"(h) x 4"(ext)	1 x 11.9w, 90CRI 3000k LED	120V 0-10V/Phase dimming	ADA COMPLY cETL us ETL damp
37-516-XX	Matte White Acrylic	14 Polished Chrome 24 Satin Nickel 25 Satin Copper 40 Aged Brass	4.75"(w) x 19.125"(h) x 4"(ext)	1 x 11.9w, 90CRI 3000k LED	277V 0-10V/Phase dimming	ADA COMPLY cETL us ETL damp

2700k, 3500k, 4000k color temperatures also available. Contact Oxygen for ordering information.

MIZAR SCONCE

ADA

LED



3-550-24

MIZAR SCONCE

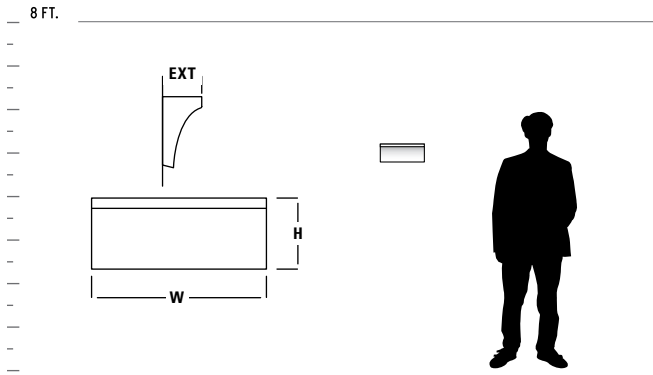

GENERAL SPECIFICATIONS:

- Cold rolled steel backplate and trim.
- Acrylic shade is 1/8", matte white finish.
- White acrylic top lens.
- Unit mounts to horizontally mounted 2"x3" junction box.
- Approved for wall mount applications only
- Total luminaire power 13w.
- Visit www.oxygenlighting.com for technical cut sheets.
- Oxygen reserves the right to modify designs at any time.



AVAILABLE FINISHES



ITEM #	DIFFUSER	FINISH	DIMENSIONS	LAMPING	DRIVER	CERTIFICATION
3-550-XX	Matte White Acrylic	22 Oiled Bronze 24 Satin Nickel 40 Aged Brass	12"(w) x 5"(h) x 2.75"(ext)	1 x 10.1w, 90CRI 3000k LED	120V 0-10V/Phase dimming	
37-550-XX	Matte White Acrylic	22 Oiled Bronze 24 Satin Nickel 40 Aged Brass	12"(w) x 5"(h) x 2.75"(ext)	1 x 10.1w, 90CRI 3000k LED	277V 0-10V/Phase dimming	

2700k, 3500k, 4000k color temperatures also available. Contact Oxygen for ordering information.

OLIO SCONCE

ADA

LED



3-538-24

OLIO SCONCE

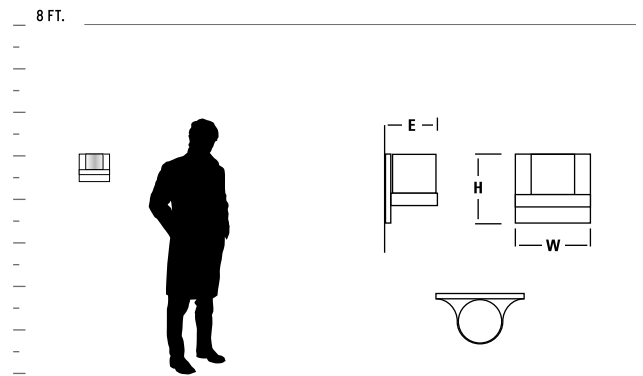

GENERAL SPECIFICATIONS:

- Cold-rolled steel housing. • Diffuser is 1/8" thick matte opal glass.
- Diffuser screws onto housing with integral threaded fitting. • Unit mounts to 4" octagonal junction box. • Approved for wall mount applications only.
- Total luminaire power 10.1w. • Visit www.oxygenlighting.com for technical cut sheets. • Oxygen reserves the right to modify designs at any time.

AVAILABLE FINISHES



ITEM #	DIFFUSER	FINISH	DIMENSIONS	LAMPING	DRIVER	CERTIFICATION
3-538-XX	Matte Opal Glass	22 Oiled Bronze 24 Satin Nickel	7"(w) x 5.5"(h) x 4"(ext)	1 x 8.2w, 90CRI 3000k LED	120V 0-10V/Phase dimming	
37-538-XX	Matte Opal Glass	22 Oiled Bronze 24 Satin Nickel	7"(w) x 5.5"(h) x 4"(ext)	1 x 8.2w, 90CRI 3000k LED	277V 0-10V/Phase dimming	

2700k, 3500k, 4000k color temperatures also available. Contact Oxygen for ordering information.

OLIO SCONCE

ADA

LED



3-539-22

OLIO SCONCE

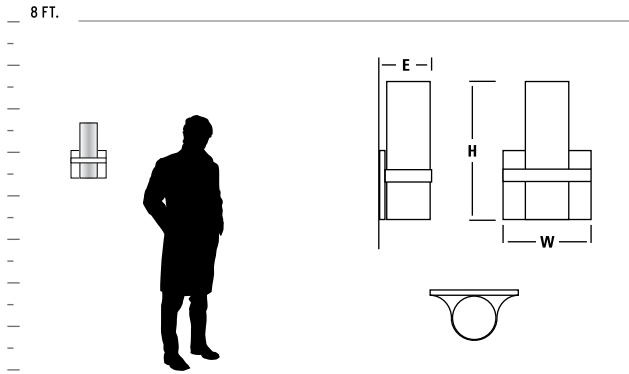

GENERAL SPECIFICATIONS:

- Cold-rolled steel housing.
- Diffuser is 1/8" thick matte opal glass.
- Diffuser screws onto housing with integral threaded fitting.
- Unit mounts to 4" octagonal junction box.
- Approved for wall mount application only.
- Total luminaire power 20.2w.
- Visit www.oxygenlighting.com for technical cut sheets.
- Oxygen reserves the right to modify designs at any time.



AVAILABLE FINISHES



ITEM #	DIFFUSER	FINISH	DIMENSIONS	LAMPING	DRIVER	CERTIFICATION
3-539-XX	Matte Opal Glass	22 Oiled Bronze 24 Satin Nickel	7"(w) x 15"(h) x 4"(ext)	2 x 8.2w, 90CRI 3000k LED	120V 0-10V/Phase dimming	
37-539-XX	Matte Opal Glass	22 Oiled Bronze 24 Satin Nickel	7"(w) x 15"(h) x 4"(ext)	2 x 8.2w, 90CRI 3000k LED	277V 0-10V/Phase dimming	

2700k, 3500k, 4000k color temperatures also available. Contact Oxygen for ordering information.

ORION SCONCE

ADA

LED



3-540-24

ORION SCONCE



3-540-40

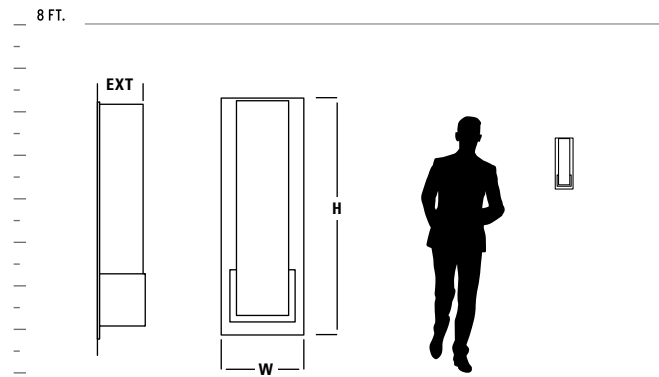

GENERAL SPECIFICATIONS:

- Cold rolled steel backplate and trim.
- Acrylic shade is 1/8", matte white finish.
- Unit mounts to 4" octagonal or 2"x3" junction box.
- Driver mounts inside junction box.
- Unit requires 2.5" deep junction box.
- Total luminaire power 15.4w.
- Visit www.oxygenlighting.com for technical cut sheets.
- Oxygen reserves the right to modify designs at any time.

AVAILABLE FINISHES



14 Polished Chrome



24 Satin Nickel

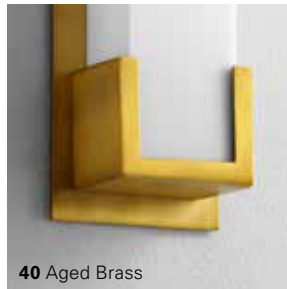

40 Aged Brass

ITEM #	DIFFUSER	FINISH	DIMENSIONS	LAMPING	DRIVER	CERTIFICATION
3-540-XX	Matte White Acrylic	14 Polished Chrome 24 Satin Nickel 40 Aged Brass	4.75"(w) x 13.5"(h) x 2.75"(ext)	1 x 11.9w, 90CRI 3000k LED	120V 0-10V/Phase dimming	
37-540-XX	Matte White Acrylic	14 Polished Chrome 24 Satin Nickel 40 Aged Brass	4.75"(w) x 13.5"(h) x 2.75"(ext)	1 x 11.9w, 90CRI 3000k LED	277V 0-10V/Phase dimming	

2700k, 3500k, 4000k color temperatures also available. Contact Oxygen for ordering information.

PATHWAYS SCONCE

ADA

LED

FLOURESCENT

EM



2-5113-624

PATHWAYS SCONCE

8 FT.

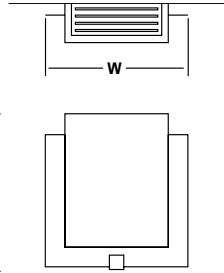
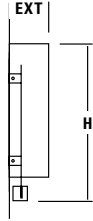

GENERAL SPECIFICATIONS:

- Cold rolled steel housing and trim.
- Acrylic diffusers are 1/8" thick, finish as specified.
- Unit mounts to 4" octagonal junction box.
- Approved for wall mount applications only
- Toolless access to lamps for fluorescent models.
- Total luminaire power 12.9w for LED models.
- Visit www.oxygenlighting.com for technical cut sheets.
- Oxygen reserves the right to modify designs at any time.

EMERGENCY BATTERY BACKUP MODELS (EM)

- ETL required 90 minute emergency battery run time
- 32 hour recharge time.



AVAILABLE FINISHES



ITEM #	DIFFUSER	FINISH	DIMENSIONS	LAMPING	BALLAST	DRIVER	CERTIFICATION
2-5113-XXX	2 Matte White Acrylic 3 Tobacco Acrylic 6 Silver Cloth Acrylic	24 Satin Nickel	13.75"(w) x 15"(h) x 3.75"(ext)	2 x 26w quad 4-pin fluorescent (G24q-3)	Electronic, HPF, Programmed Start, Universal Voltage (120-277V)	--	ADA COMPLIANT, cETL US, UL damp
3-523-XXX	2 Matte White Acrylic 3 Tobacco Acrylic 6 Silver Cloth Acrylic	24 Satin Nickel 95 Old World	13.75"(w) x 15"(h) x 3.75"(ext)	1 x 10.1w, 90CRI 3000k LED	--	120V 0-10V/Phase dimming	ADA COMPLIANT, cETL US, ETL damp
37-523-XXX	2 Matte White Acrylic 3 Tobacco Acrylic 6 Silver Cloth Acrylic	24 Satin Nickel 95 Old World	13.75"(w) x 15"(h) x 3.75"(ext)	1 x 10.1w, 90CRI 3000k LED	--	277V 0-10V/Phase dimming	ADA COMPLIANT, cETL US, ETL damp
3-523-2XX-EM	2 Matte White Acrylic	24 Satin Nickel 95 Old World	13.75"(w) x 15"(h) x 3.75"(ext)	1 x 10.1w, 90CRI 3000k LED	--	120V 0-10V/Phase dimming	ADA COMPLIANT, cETL US, ETL damp, EM
37-523-2XX-EM	2 Matte White Acrylic	24 Satin Nickel 95 Old World	13.75"(w) x 15"(h) x 3.75"(ext)	1 x 10.1w, 90CRI 3000k LED	--	277V 0-10V/Phase dimming	ADA COMPLIANT, cETL US, ETL damp, EM

2700k, 3500k, 4000k color temperatures also available for non EM LED models. Contact Oxygen for ordering information.

PEBBLE SCONCE

FLOURESCENT



2-5156-124

PEBBLE SCONCE

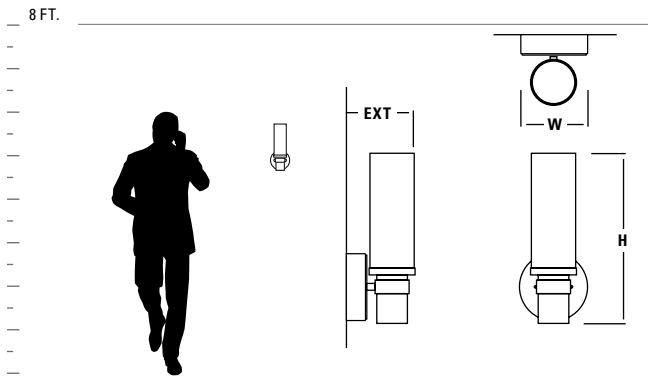

GENERAL SPECIFICATIONS:

- Cast and machined steel fittings. • Diffuser screws onto housing with integral threaded fitting.
- Glass diffusers are 1/8" thick white opal duplex glass. • Open top. • Units mounts to 4" octagonal junction box. • Visit www.oxygenlighting.com for technical cut sheets. • Oxygen reserves the right to modify designs at any time.

AVAILABLE FINISH



ITEM #	DIFFUSER	FINISH	DIMENSIONS	LAMPING	BALLAST	CERTIFICATION
2-5156-124	1 White Opal Glass	24 Satin Nickel	6"(w) x 12.75"(h) x 5.5"(ext)	1 x 18w quad 4-pin fluorescent (G24q-2)	Electronic, HPF, Programmed Start, Universal Voltage (120-277V)	c

POLARIS SCONCE

ADA

LED

EM



3-522-24

POLARIS SCONCE

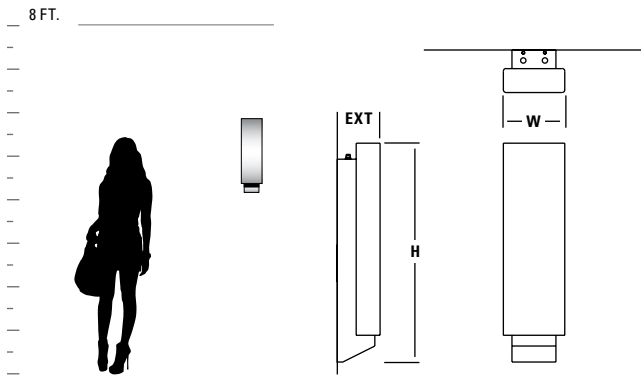

GENERAL SPECIFICATIONS:

- Cold rolled steel housing.
- Acrylic diffusers are 1/8" thick matte white with closed top and bottom.
- Unit mounts to 4" octagonal junction box.
- Approved for wall mount applications only
- Total luminaire power 15.4w.
- Visit www.oxygenlighting.com for technical cut sheets.
- Oxygen reserves the right to modify designs at any time.

EMERGENCY BATTERY BACKUP MODELS (EM)

- ETL required 90 minute emergency battery run time
- 32 hour recharge time.



AVAILABLE FINISH



ITEM #	DIFFUSER	FINISH	DIMENSIONS	LAMPING	DRIVER	CERTIFICATION
3-522-24	Matte White Acrylic	24 Satin Nickel	5.75"(w) x 20.5"(h) x 4"(ext)	1 x 10.1w, 90CRI 3000k LED	120V 0-10V/Phase dimming	ADA COMPLIANT, ETL US, ETL damp
37-522-24	Matte White Acrylic	24 Satin Nickel	5.75"(w) x 20.5"(h) x 4"(ext)	1 x 10.1w, 90CRI 3000k LED	277V 0-10V/Phase dimming	ADA COMPLIANT, ETL US, ETL damp
3-522-24-EM	Matte White Acrylic	24 Satin Nickel	5.75"(w) x 20.5"(h) x 4"(ext)	1 x 10.1w, 90CRI 3000k LED	120V 0-10V/Phase dimming	ADA COMPLIANT, ETL US, ETL damp, EM
37-522-24-EM	Matte White Acrylic	24 Satin Nickel	5.75"(w) x 20.5"(h) x 4"(ext)	1 x 10.1w, 90CRI 3000k LED	277V 0-10V/Phase dimming	ADA COMPLIANT, ETL US, ETL damp, EM

2700k, 3500k, 4000k color temperatures also available for non EM LED models. Contact Oxygen for ordering information.

PROFILE SCONCE

ADA

LED



3-517-14

Shown With Optional Cover Plate (Included)

PROFILE SCONCE

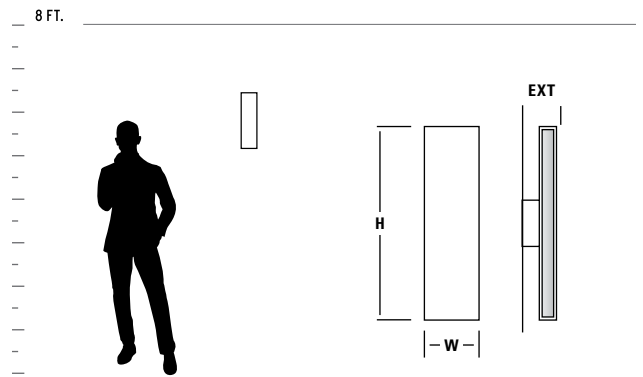

GENERAL SPECIFICATIONS:

- Cold rolled steel housing and trim. • Matte white acrylic diffuser. • Unit mounts to 2" x 3" junction box. • Supplied with 4.75" x 6" cover plate for mounting to 4" octagonal junction box. • Approved for vertical mounting.
- Approved for wall mount applications only. • Total luminaire power 29.8w.
- Visit www.oxygenlighting.com for technical cut sheets.
- Oxygen reserves the right to modify designs at any time.

AVAILABLE FINISHES



14 Polished Chrome



24 Satin Nickel

ITEM #	DIFFUSER	FINISH	DIMENSIONS	LAMPING	DRIVER	CERTIFICATION
3-517-XX	Matte White Acrylic	14 Polished Chrome 24 Satin Nickel	4.5"(w) x 16"(h) x 3"(ext) w/o optional plate	2 x 11.9w, 90CRI 3000k LED	120V 0-10V/Phase dimming	
37-517-XX	Matte White Acrylic	14 Polished Chrome 24 Satin Nickel	4.5"(w) x 16"(h) x 3"(ext) w/o optional plate	2 x 11.9w, 90CRI 3000k LED	277V 0-10V/Phase dimming	

2700k, 3500k, 4000k color temperatures also available. Contact Oxygen for ordering information.

REFLEX SCONCE

ADA

LED



3-504-40

Shown With Optional Cover Plate (Included)

REFLEX SCONCE

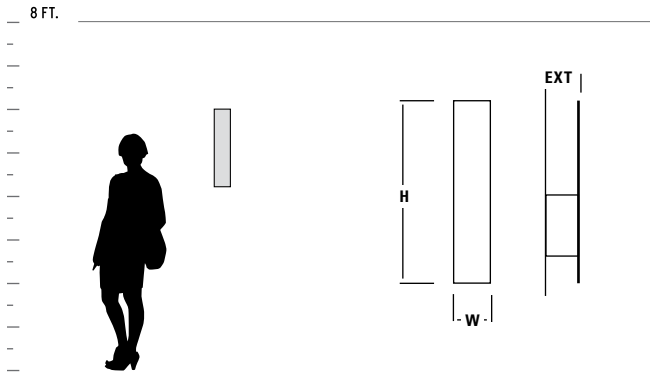





GENERAL SPECIFICATIONS:

- Cold rolled steel housing and trim.
- Unit mounts to 2" x 3" junction box.
- Supplied with 4.75" x 6" cover plate for mounting to 4" octagonal junction box.
- Approved for vertical mounting.
- Approved for wall mount applications only.
- Visit www.oxygenlighting.com for technical cut sheets.
- Oxygen reserves the right to modify designs at any time.

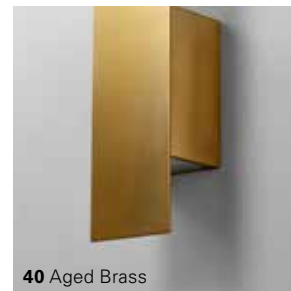

AVAILABLE FINISHES



ITEM #	DIFFUSER	FINISH	DIMENSIONS	LAMPING	CERTIFICATION
3-504-XX	Frosted Glass	14 Polished Chrome 24 Satin Nickel 25 Satin Copper 40 Aged Brass	4"(w) x 20"(h) x 3.5"(ext) w/o optional plate	2 x 7w MAX GU10 120V LED ONLY (lamps not included)	  

SIREN SCONCE

ADA

LED



SIREN SCONCE

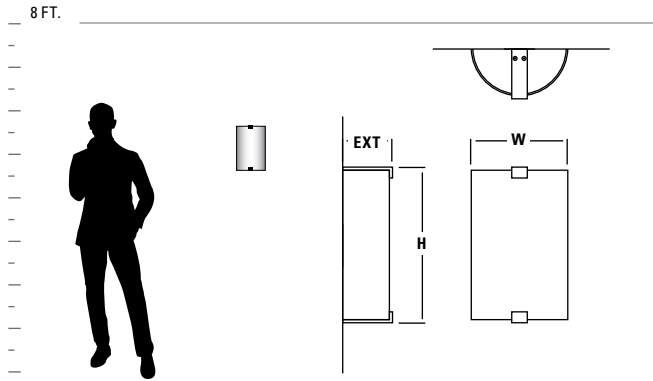

GENERAL SPECIFICATIONS:

- Cold rolled steel housing. • Cast steel trim. • Glass diffuser is 1/4" thick white opal duplex glass.
- Acrylic shades are 1/8" thick. • White acrylic top and bottom lense with acrylic diffuser options.
- Perforated steel top and bottom lense with white opal glass option. • Unit mounts to 4" octagonal junction box. • Approved for wall mount application only. • Total luminaire power 13.2w.
- Visit www.oxygenlighting.com for technical cut sheets. • Oxygen reserves the right to modify designs at any time.



AVAILABLE FINISHES



ITEM #	DIFFUSER	FINISH	DIMENSIONS	LAMPING	DRIVER	CERTIFICATION
3-563-XXX	1 White Opal Glass 2 Matte White Acrylic	14 Polished Chrome 24 Satin Nickel	7.75"(w) x 12.5"(h) x 4"(ext)	1 x 10.1w, 90CRI 3000k LED	120V 0-10V/Phase dimming	
37-563-XXX	1 White Opal Glass 2 Matte White Acrylic	14 Polished Chrome 24 Satin Nickel	7.75"(w) x 12.5"(h) x 4"(ext)	1 x 10.1w, 90CRI z3000k LED	277V 0-10V/Phase dimming	

2700k, 3500k, 4000k color temperatures also available. Contact Oxygen for ordering information.

SONGBIRD SCONCE

ADA

LED



3-589-214

SONGBIRD SCONCE

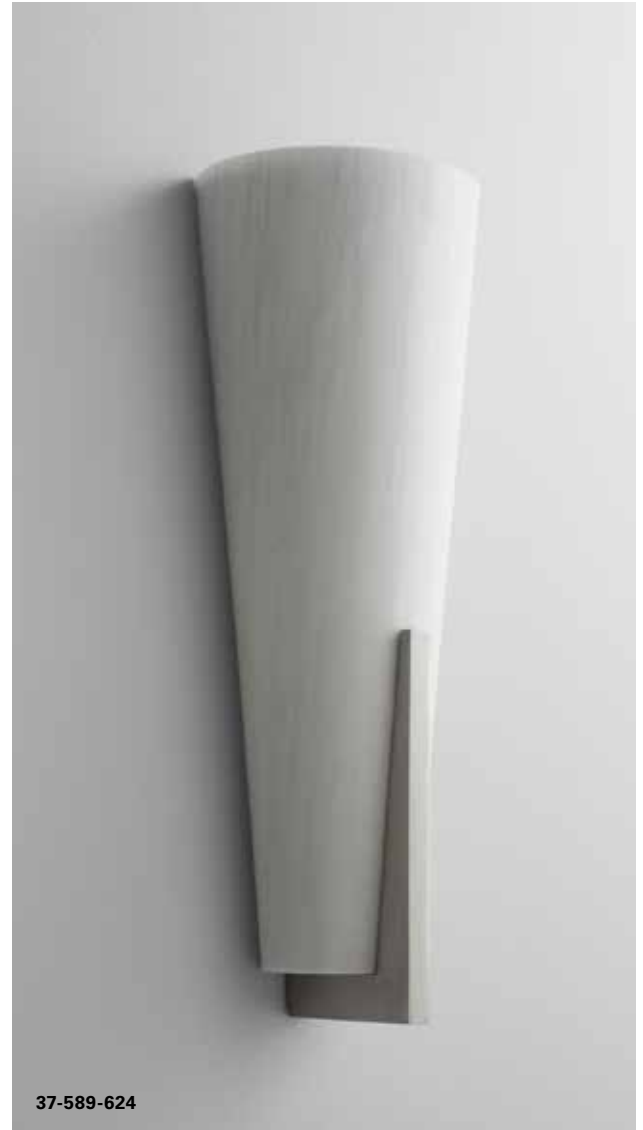
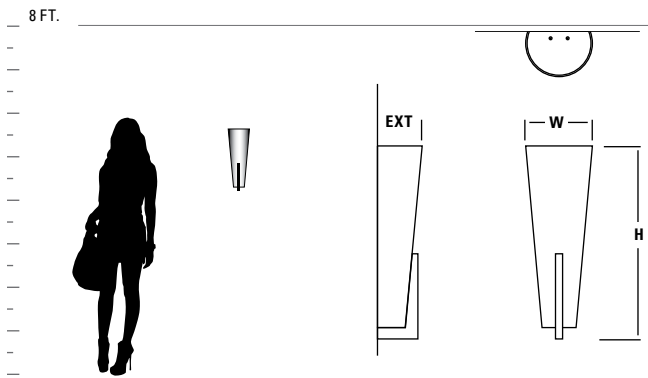

GENERAL SPECIFICATIONS:

- Cold rolled steel housing. • Cast steel trim. • Acrylic diffusers are 1/8" thick, finish as specified. • Glass diffuser is 1/4" thick white opal duplex glass. • All units mount to vertical 2"x3" or 4" octagonal junction box. • Approved for wall mount application only.
- Total luminaire power 13.3w. • Visit www.oxygenlighting.com for technical cut sheets. • Oxygen reserves the right to modify designs at any time.

AVAILABLE FINISHES



ITEM #	DIFFUSER	FINISH	DIMENSIONS	LAMPING	DRIVER	CERTIFICATION
3-589-XXX	1 Matte Opal Glass 2 Matte White Acrylic 6 Silver Cloth Acrylic	14 Polished Chrome 24 Satin Nickel	6"(w) x 17"(h) x 4"(ext)	1 x 10.1w, 90CRI 3000k LED	120V 0-10V/Phase dimming	
37-589-XXX	1 Matte Opal Glass 2 Matte White Acrylic 6 Silver Cloth Acrylic	14 Polished Chrome 24 Satin Nickel	6"(w) x 17"(h) x 4"(ext)	1 x 10.1w, 90CRI 3000k LED	277V 0-10V/Phase dimming	

2700k, 3500k, 4000k color temperatures also available. Contact Oxygen for ordering information.

UNO SCONCE

ADA

LED



3-500-18

UNO SCONCE

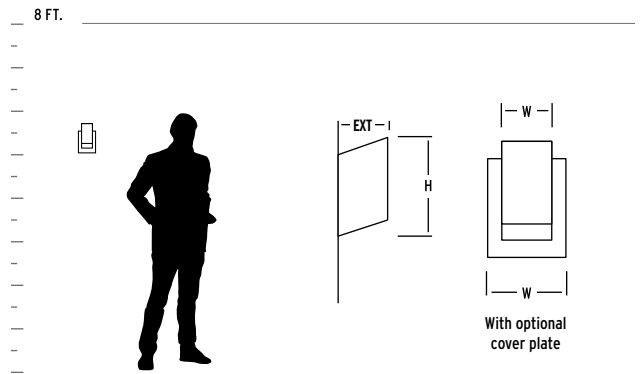

GENERAL SPECIFICATIONS:

- Cold rolled steel housing.
- Frosted glass diffuser.
- Unit mounts to 2"x3" junction box.
- Supplied with 4.75"x6" cover plate for mounting to 4" octagonal junction box.
- Approved for vertical mounting.
- Approved for wall mount applications only.
- Visit www.oxygenlighting.com for technical cut sheets.
- Oxygen reserves the right to modify designs at any time.

AVAILABLE FINISHES



ITEM #	DIFFUSER	FINISH	DIMENSIONS	LAMPING	CERTIFICATION
3-500-XX	Frosted Glass	14 Polished Chrome 18 Gunmetal 24 Satin Nickel 25 Satin Copper 40 Aged Brass	3"(w) x 6.75"(h) x 3"(ext) w/o optional cover plate	1 x 7w MAX GU10 120V LED ONLY (lamp not included)	

VEGA SCONCE

ADA

LED



3-519-20

VEGA SCONCE

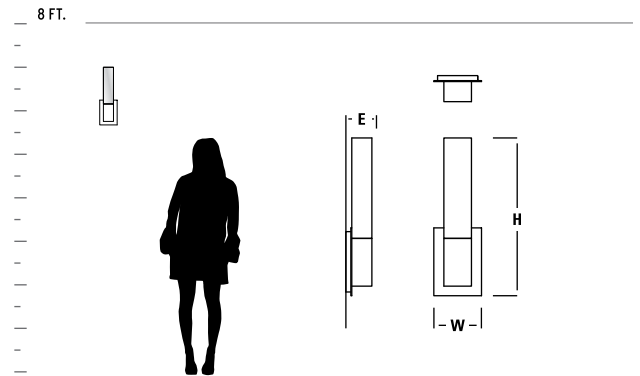

GENERAL SPECIFICATIONS:

- Cold-rolled steel housing.
- Diffuser is 1/8" thick matte white acrylic.
- Unit mounts to 2"x3" or 4" octagonal junction box.
- Approved for wall mount applications only.
- Total luminaire power 15.5w.
- Visit www.oxygenlighting.com for technical cut sheets.
- Oxygen reserves the right to modify designs at any time.

AVAILABLE FINISHES



20 Polished Nickel



24 Satin Nickel

ITEM #	DIFFUSER	FINISH	DIMENSIONS	LAMPING	DRIVER	CERTIFICATION
3-519-XX	Matte White Acrylic	20 Polished Nickel 24 Satin Nickel	4.75"(w) x 15.75"(h) x 2.625"(ext)	1 x 11.9w, 90CRI 3000k LED	120V 0-10V/Phase dimming	
37-519-XX	Matte White Acrylic	20 Polished Nickel 24 Satin Nickel	4.75"(w) x 15.75"(h) x 2.625"(ext)	1 x 11.9w, 90CRI 3000k LED	277V 0-10V/Phase dimming	

2700k, 3500k, 4000k color temperatures also available. Contact Oxygen for ordering information.

VELA SCONCE

ADA

LED



3-527-24

VELA SCONCE

8 FT.

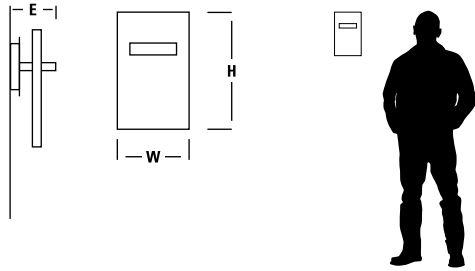

GENERAL SPECIFICATIONS:

- Cold-rolled steel housing.
- Diffuser is 1/8" thick matte white acrylic.
- Unit mounts to 4" octagonal junction box.
- Approved for wall mount application only.
- Total luminaire power 20.2w.
- Visit www.oxygenlighting.com for technical cut sheets.
- Oxygen reserves the right to modify designs at any time.



AVAILABLE FINISHES



ITEM #	DIFFUSER	FINISH	DIMENSIONS	LAMPING	DRIVER	CERTIFICATION
3-527-XX	Matte White Acrylic	20 Polished Nickel 22 Oiled Bronze 24 Satin Nickel	6.875"(w) x 12"(h) x 4"(ext)	2 x 8.2w, 90CRI 3000k LED	120V 0-10V/Phase dimming	
37-527-XX	Matte White Acrylic	20 Polished Nickel 22 Oiled Bronze 24 Satin Nickel	6.875"(w) x 12"(h) x 4"(ext)	2 x 8.2w, 90CRI 3000k LED	277V 0-10V/Phase dimming	

2700k, 3500k, 4000k color temperatures also available. Contact Oxygen for ordering information.

ZEEPERS SCONCE

ADA

LED



3-560-24

ZEEPERS SCONCE

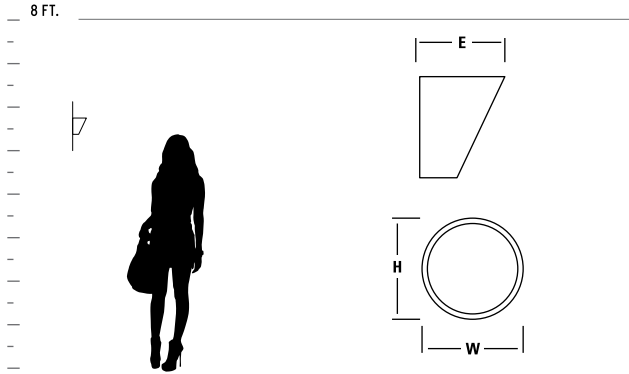





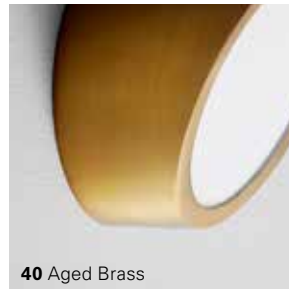

GENERAL SPECIFICATIONS:

- Cold rolled steel backplate and trim.
- Acrylic shade is 1/8", matte white finish.
- Unit mounts to 4" octagonal or 2"x3" junction box.
- Driver mounts inside junction box.
- Unit requires 2.5" deep junction box.
- Approved for wall and ceiling mount applications.
- Total luminaire power 10.4w.
- Visit www.oxygenlighting.com for technical cut sheets.
- Oxygen reserves the right to modify designs at any time.



AVAILABLE FINISHES



ITEM #	DIFFUSER	FINISH	DIMENSIONS	LAMPING	DRIVER	CERTIFICATION
3-560-XX	Matte White Acrylic	22 Oiled Bronze 24 Satin Nickel 40 Aged Brass	4.75"(w) x 4.75"(h) x 3.875"(ext)	1 x 8.2w, 90CRI 3000k LED	120V 0-10V/Phase dimming	  
37-560-XX	Matte White Acrylic	22 Oiled Bronze 24 Satin Nickel 40 Aged Brass	4.75"(w) x 4.75"(h) x 3.875"(ext)	1 x 8.2w, 90CRI 3000k LED	277V 0-10V/Phase dimming	  

2700k, 3500k, 4000k color temperatures also available. Contact Oxygen for ordering information.

ZETA SCONCE

ADA

LED



3-530-40

ZETA SCONCE

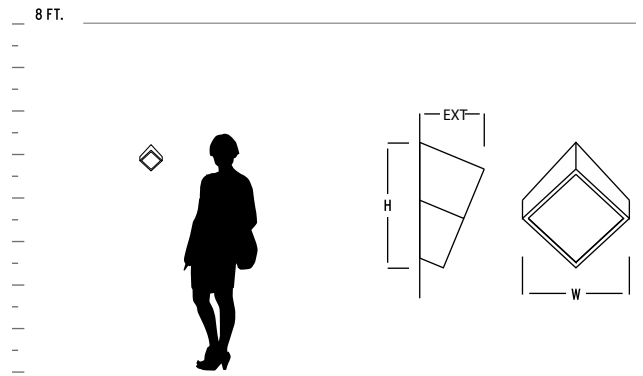

GENERAL SPECIFICATIONS:

- Cold rolled steel backplate and trim.
- Acrylic shade is 1/8", matte white finish.
- Unit mounts to 4" octagonal or 2"x3" junction box.
- Driver mounts inside junction box.
- Unit requires 2.5" deep junction box.
- Approved for wall and ceiling mount applications.
- Total luminaire power 10.3w.
- Visit www.oxygenlighting.com for technical cut sheets.
- Oxygen reserves the right to modify designs at any time.

AVAILABLE FINISHES



ITEM #	DIFFUSER	FINISH	DIMENSIONS	LAMPING	DRIVER	CERTIFICATION
3-530-XX	Matte White Acrylic	22 Oiled Bronze 24 Satin Nickel 40 Aged Brass	6.75"(w) x 7.75"(h) x 4"(ext)	1 x 8.2w, 90CRI 3000k LED	120V 0-10V/Phase dimming	
37-530-XX	Matte White Acrylic	22 Oiled Bronze 24 Satin Nickel 40 Aged Brass	6.75"(w) x 7.75"(h) x 4"(ext)	1 x 8.2w, 90CRI 3000k LED	277V 0-10V/Phase dimming	

2700k, 3500k, 4000k color temperatures also available. Contact Oxygen for ordering information.

A large white circle is centered on a background of horizontal wood grain. The word "vanities" is written in a white, lowercase, sans-serif font inside the circle.

vanities



ADAGIO VANITY

ADA

LED



3-571-20



3-571-24

ADAGIO VANITY



3-571-20



37-571-24

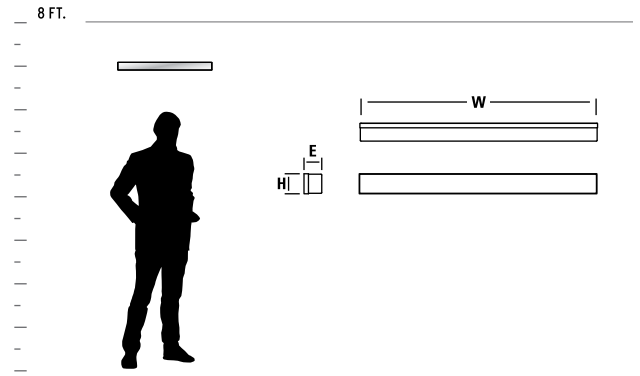

GENERAL SPECIFICATIONS:

- Cold-rolled steel housing. • Diffuser is 1/8" thick matte white acrylic.
- Unit mounts to 2"x3" junction box. • Approved for wall mount application only. • Approved for vertical or horizontal mounting. • Total luminaire power 14.9w. • Visit www.oxygenlighting.com for technical cut sheets. • Oxygen reserves the right to modify designs at any time.

AVAILABLE FINISHES



20 Polished Nickel



24 Satin Nickel

ITEM #	DIFFUSER	FINISH	DIMENSIONS	LAMPING	DRIVER	CERTIFICATION
3-571-XX	Matte White Acrylic	20 Polished Nickel 24 Satin Nickel	26.75"(w) x 2.25"(h) x 2"(ext)	1 x 11.9w, 90CRI 3000k LED	120V 0-10V/Phase dimming	
37-571-XX	Matte White Acrylic	20 Polished Nickel 24 Satin Nickel	26.75"(w) x 2.25"(h) x 2"(ext)	1 x 11.9w, 90CRI 3000k LED	277V 0-10V/Phase dimming	

2700k, 3500k, 4000k color temperatures also available. Contact Oxygen for ordering information.

ADELPHI VANITY

ADA

LED

FLOURESCENT

ENERGY STAR



2-5170-224

ADELPHI VANITY

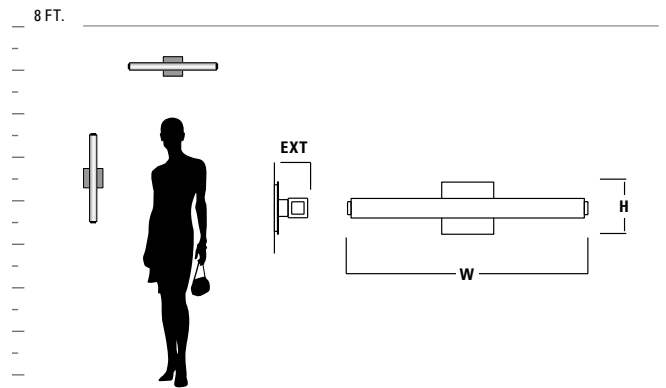

GENERAL SPECIFICATIONS:

- Cold rolled steel housing. • Diffuser is 1/8" thick matte white acrylic.
- Installs on 4" octagonal junction box. • Toolless access to lamp. for fluorescent model. • Approved for vertical or horizontal mounting.
- Approved for wall mount application only. • Total luminaire power 29.6w for 3-536-XX/37-536-XX and 15w for 3-537-XX/37-357-XX. • Visit www.oxygenlighting.com for technical cut sheets. • Oxygen reserves the right to modify designs at any time.

AVAILABLE FINISHES



ITEM #	DIFFUSER	FINISH	DIMENSIONS	LAMPING	BALLAST	DRIVER	CERTIFICATION
2-5170-224	Matte White Acrylic	24 Satin Nickel	24.25" (w) x 5.25" (h) x 3.5" (ext)	1 x 14w T5 fluorescent (mini bi-pin)	Electronic, HPF, Programmed Start, Universal Voltage (120-277V)	--	
3-536-XX	Matte White Acrylic	22 Oiled Bronze 24 Satin Nickel 40 Aged Brass	46.375" (w) x 4.75" (h) x 3.5" (ext)	2 x 11.6w, 90CRI 3000k LED	--	120V 0-10V/Phase dimming.	
37-536-XX	Matte White Acrylic	22 Oiled Bronze 24 Satin Nickel 40 Aged Brass	46.375" (w) x 4.75" (h) x 3.5" (ext)	2 x 11.6w, 90CRI 3000k LED	--	277V 0-10V/Phase dimming.	
3-537-XX	Matte White Acrylic	22 Oiled Bronze 24 Satin Nickel 40 Aged Brass	24.25" (w) x 5.25" (h) x 3.5" (ext)	1 x 11.6w, 90CRI 3000k LED	--	120V 0-10V/Phase dimming.	
37-537-XX	Matte White Acrylic	22 Oiled Bronze 24 Satin Nickel 40 Aged Brass	24.25" (w) x 5.25" (h) x 3.5" (ext)	1 x 11.6w, 90CRI 3000k LED	--	277V 0-10V/Phase dimming.	

2700k, 3500k, 4000k color temperatures also available for LED models. Contact Oxygen for ordering information.

APOLLO VANITY

ADA

FLOURESCENT



2-5105-24 & 2-5106-24

APOLLO VANITY

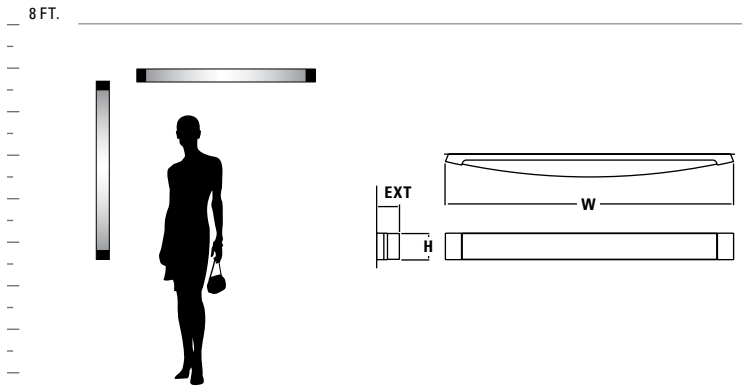









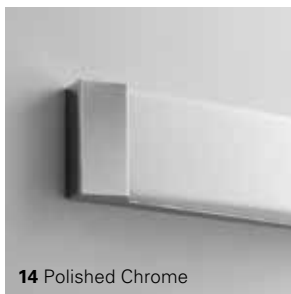



GENERAL SPECIFICATIONS:

- Cold-rolled steel housing.
- Diffusers are 1/8" thick matte white acrylic.
- Installs to 4" octagonal junction box.
- Toolless access to lamps.
- Approved for vertical or horizontal mounting.
- Approved for wall applications only.
- Visit www.oxygenlighting.com for technical cut sheets.
- Oxygen reserves the right to modify designs at any time.



AVAILABLE FINISHES



ITEM #	DIFFUSER	FINISH	DIMENSIONS	LAMPING	BALLAST	CERTIFICATION
2-5104-XX small	Matte White Acrylic	14 Polished Chrome 24 Satin Nickel	25.25"(w) x 4.75"(h) x 3"(ext)	2 x 14w T5 linear fluorescent (mini bi-pin)	Electronic HPF, Rapid Start, Universal Voltage (120-277V)	   
2-5105-XX medium	Matte White Acrylic	14 Polished Chrome 24 Satin Nickel	37.25"(w) x 4.75"(h) x 3.75"(ext)	2 x 21w T5 linear fluorescent (mini bi-pin)	Electronic HPF, Rapid Start, Universal Voltage (120-277V)	   
2-5106-XX large	Matte White Acrylic	14 Polished Chrome 24 Satin Nickel	49"(w) x 4.75"(h) x 4"(ext)	2 x 28w T5 linear fluorescent (mini bi-pin)	Electronic HPF, Programmed Start, Universal Voltage (120-277V)	   

APOLLO VANITY

ADA

LED

ENERGY STAR



3-525-22



3-525-40

APOLLO VANITY

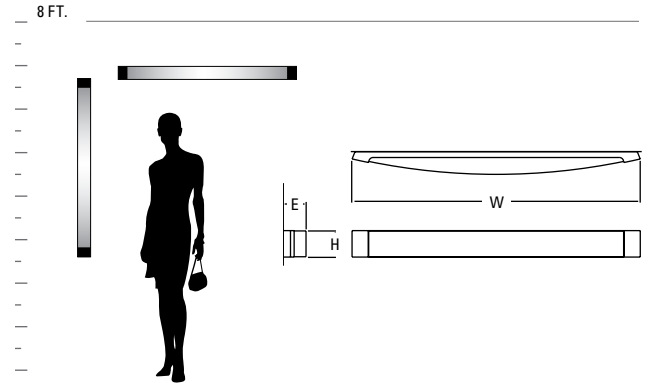

GENERAL SPECIFICATIONS:

- Cold rolled steel housing and trim.
- Diffusers are 1/8" thick matte white acrylic.
- Unit mounts to 2"x3" junction box.
- Approved for horizontal or vertical mounting.
- Approved for wall mount applications only.
- Total luminaire power 26.1w for 3-524-XX/37-524-XX, 25.9w for 3-525-XX/37-525-XX, and 29.6w for 3-526-XX/37-526-XX.
- Visit www.oxygenlighting.com for technical cut sheets.
- Oxygen reserves the right to modify designs at any time.

AVAILABLE FINISHES



14 Polished Chrome



22 Oiled Bronze



24 Satin Nickel



40 Aged Brass

ITEM #	DIFFUSER	FINISH	DIMENSIONS	LAMPING	DRIVER	CERTIFICATION
3-524-XX small	Matte White Acrylic	14 Polished Chrome 22 Oiled Bronze 24 Satin Nickel 40 Aged Brass	27.75"(w) x 2.75"(h) x 2.5"(ext)	2 x 10.1w, 90CRI 3000k LED	120V 0-10V/Phase dimming	
37-524-XX small	Matte White Acrylic	14 Polished Chrome 22 Oiled Bronze 24 Satin Nickel 40 Aged Brass	27.75"(w) x 2.75"(h) x 2.5"(ext)	2 x 10.1w, 90CRI 3000k LED	277V 0-10V/Phase dimming	
3-525-XX medium	Matte White Acrylic	14 Polished Chrome 22 Oiled Bronze 24 Satin Nickel 40 Aged Brass	31.75"(w) x 2.75"(h) x 2.5"(ext)	2 x 10.1w, 90CRI 3000k LED	120V 0-10V/Phase dimming	
37-525-XX medium	Matte White Acrylic	14 Polished Chrome 22 Oiled Bronze 24 Satin Nickel 40 Aged Brass	31.75"(w) x 2.75"(h) x 2.5"(ext)	2 x 10.1w, 90CRI 3000k LED	277V 0-10V/Phase dimming	
3-526-XX large	Matte White Acrylic	14 Polished Chrome 22 Oiled Bronze 24 Satin Nickel 40 Aged Brass	54"(w) x 2.75"(h) x 2.5"(ext)	2 x 11.6w, 90CRI 3000k LED	120V 0-10V/Phase dimming	
37-526-XX large	Matte White Acrylic	14 Polished Chrome 22 Oiled Bronze 24 Satin Nickel 40 Aged Brass	54"(w) x 2.75"(h) x 2.5"(ext)	2 x 11.6w, 90CRI 3000k LED	277V 0-10V/Phase dimming	

2700k, 3500k, 4000k color temperatures also available. Contact Oxygen for ordering information.

ARCHER VANITY

ADA

LED



3-575-24

ARCHER VANITY

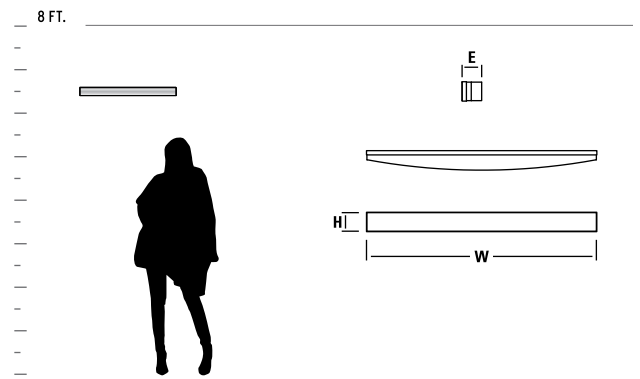

GENERAL SPECIFICATIONS:

- Cold-rolled steel housing. • Diffuser is 1/8" thick matte white acrylic.
- Unit mounts to horizontal 2"x3" junction box. • Approved for wall mount application only. • Approved for vertical or horizontal mounting. • Total luminaire power 14.6w. • Visit www.oxygenlighting.com for technical cut sheets. • Oxygen reserves the right to modify designs at any time.

AVAILABLE FINISHES



ITEM #	DIFFUSER	FINISH	DIMENSIONS	LAMPING	DRIVER	CERTIFICATION
3-575-XX	Matte White Acrylic	20 Polished Nickel 24 Satin Nickel	26.75"(w) x 2.25"(h) x 2.5"(ext)	1 x 11.9w, 90CRI 3000k LED	120V 0-10V/Phase dimming	
37-575-XX	Matte White Acrylic	20 Polished Nickel 24 Satin Nickel	26.75"(w) x 2.25"(h) x 2.5"(ext)	1 x 11.9w, 90CRI 3000k LED	277V 0-10V/Phase dimming	

2700k, 3500k, 4000k color temperatures also available. Contact Oxygen for ordering information.

AXEL VANITY

ADA

LED



3-552-20

AXEL VANITY

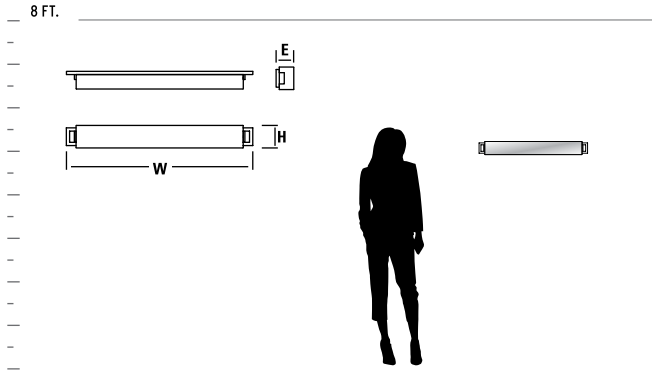

GENERAL SPECIFICATIONS:

- Cold-rolled steel housing.
- Diffuser is 1/8" thick matte white acrylic.
- Unit mounts to 2"x3" junction box.
- Approved for wall mount application only.
- Approved for vertical or horizontal mounting.
- Total luminaire power 14.5w.
- Visit www.oxygenlighting.com for technical cut sheets.
- Oxygen reserves the right to modify designs at any time.



AVAILABLE FINISHES



ITEM #	DIFFUSER	FINISH	DIMENSIONS	LAMPING	DRIVER	CERTIFICATION
3-552-XX	Matte White Acrylic	20 Polished Nickel 24 Satin Nickel	29"(w) x 3.5"(h) x 2.75"(ext)	1 x 11.9w, 90CRI 3000k LED	120V 0-10V/Phase dimming	
37-552-XX	Matte White Acrylic	20 Polished Nickel 24 Satin Nickel	29"(w) x 3.5"(h) x 2.75"(ext)	1 x 11.9w, 90CRI 3000k LED	277V 0-10V/Phase dimming	

2700k, 3500k, 4000k color temperatures also available. Contact Oxygen for ordering information.

BALANCE VANITY

ADA

FLOURESCENT



2-5137-24



2-5138-24-BP324

BALANCE VANITY

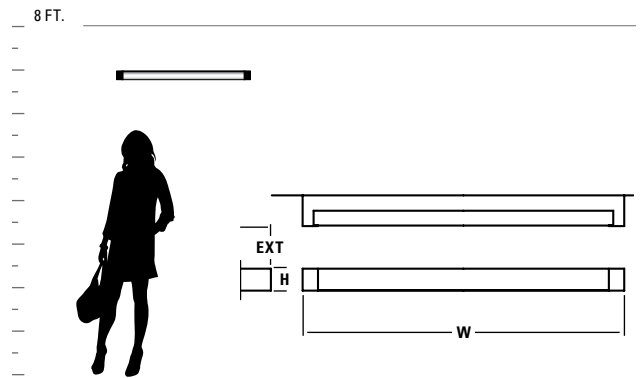

GENERAL SPECIFICATIONS:

- Cold rolled steel housing. • Diffusers are 1/8" thick matte white acrylic.
- All units mount to horizontal 2"x3" junction box as standard, or 4" octagonal junction box with optional accessory backplate. • Approved for horizontal mounting only. • Toolless access to lamps. • Visit www.oxygenlighting.com for technical cut sheets. • Oxygen reserves the right to modify designs at any time.

AVAILABLE FINISH



ITEM #	DIFFUSER	FINISH	DIMENSIONS	LAMPING	BALLAST	CERTIFICATION
2-5137-24 small	Matte White Acrylic	24 Satin Nickel	24.75"(w) x 2.5"(h) x 3.5"(ext)	1 x 24w T5HO fluorescent (mini bi-pin)	Electronic, HPF, Programmed Start, Universal Voltage (120V - 277V)	ADA COMPLIANT
2-5138-24 medium	Matte White Acrylic	24 Satin Nickel	36.5"(w) x 2.5"(h) x 3.5"(ext)	1 x 39w T5HO fluorescent (mini bi-pin)	Electronic, HPF, Programmed Start, Universal Voltage (120V - 277V)	ADA COMPLIANT
2-5137-24-BP224 small	Matte White Acrylic	24 Satin Nickel	26.75"(w) x 4.5"(h) x 4"(ext)	1 x 24w T5HO fluorescent (mini bi-pin)	Electronic, HPF, Programmed Start, Universal Voltage (120V - 277V)	ADA COMPLIANT
2-5138-24-BP324 medium	Matte White Acrylic	24 Satin Nickel	38.5"(w) x 4.5"(h) x 4"(ext)	1 x 39w T5HO fluorescent (mini bi-pin)	Electronic, HPF, Programmed Start, Universal Voltage (120V - 277V)	ADA COMPLIANT

BALANCE VANITY

ADA

LED



3-547-20-BP220

BALANCE VANITY

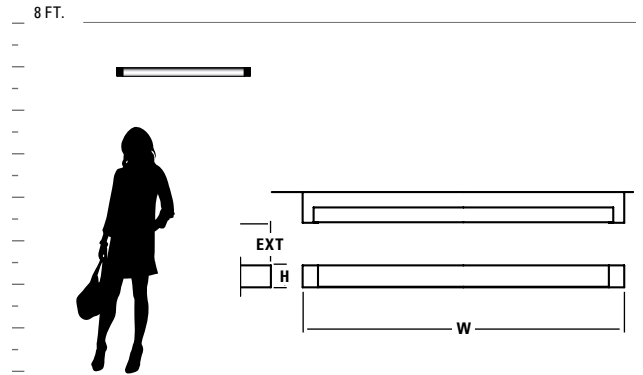

GENERAL SPECIFICATIONS:

- Cold rolled steel housing. • Diffusers are 1/8" thick matte white acrylic. • All units mount to horizontal 2"x3" junction box or 4" octagonal junction box with optional accessory backplate. • Approved for horizontal mounting only. • Approved for wall mount application only. • Total luminaire power 14.5w for 3-547-XX/37-547-XX and 28.6w for 3-549-XX/37-549-XX. • Visit www.oxygenlighting.com for technical cut sheets. • Oxygen reserves the right to modify designs at any time.

AVAILABLE FINISHES

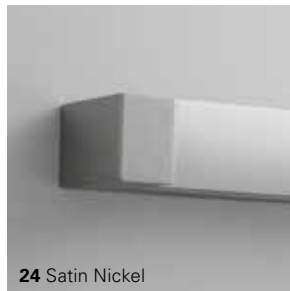
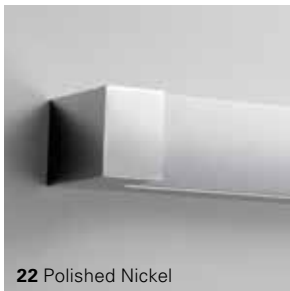

ITEM #	DIFFUSER	FINISH	DIMENSIONS	LAMPING	DRIVER	CERTIFICATION
3-547-XX small	Matte White Acrylic	20 Polished Nickel 24 Satin Nickel	24.75"(w) x 2.5"(h) x 3.5"(ext)	1 x 11.9w, 90CRI 3000k LED	120V 0-10V/Phase dimming	
3-547-XX-BP2XX small w/ backplate	Matte White Acrylic	20 Polished Nickel 24 Satin Nickel	29"(w) x 4.5"(h) x 4"(ext)	1 x 11.9w, 90CRI 3000k LED	120V 0-10V/Phase dimming	
37-547-XX small	Matte White Acrylic	20 Polished Nickel 24 Satin Nickel	24.75"(w) x 2.5"(h) x 3.5"(ext)	1 x 11.9w, 90CRI 3000k LED	277V 0-10V/Phase dimming	
37-547-XX-BP2XX small w/ backplate	Matte White Acrylic	20 Polished Nickel 24 Satin Nickel	29"(w) x 4.5"(h) x 4"(ext)	1 x 11.9w, 90CRI 3000k LED	277V 0-10V/Phase dimming	
3-549-XX large	Matte White Acrylic	20 Polished Nickel 24 Satin Nickel	48.5"(w) x 2.5"(h) x 3.5"(ext)	2 x 11.9w, 90CRI 3000k LED	120V 0-10V/Phase dimming	
3-549-XX-BP4XX large w/ backplate	Matte White Acrylic	20 Polished Nickel 24 Satin Nickel	52.75"(w) x 4.5"(h) x 4"(ext)	2 x 11.9w, 90CRI 3000k LED	120V 0-10V/Phase dimming	
37-549-XX large	Matte White Acrylic	20 Polished Nickel 24 Satin Nickel	48.5"(w) x 2.5"(h) x 3.5"(ext)	2 x 11.9w, 90CRI 3000k LED	277V 0-10V/Phase dimming	
37-549-XX-BP4XX large w/ backplate	Matte White Acrylic	20 Polished Nickel 24 Satin Nickel	52.75"(w) x 4.5"(h) x 4"(ext)	2 x 11.9w, 90CRI 3000k LED	277V 0-10V/Phase dimming	

2700k, 3500k, 4000k color temperatures also available. Contact Oxygen for ordering information.

CRESCENT VANITY

ADA

LED



3-582-14

CRESCENT VANITY

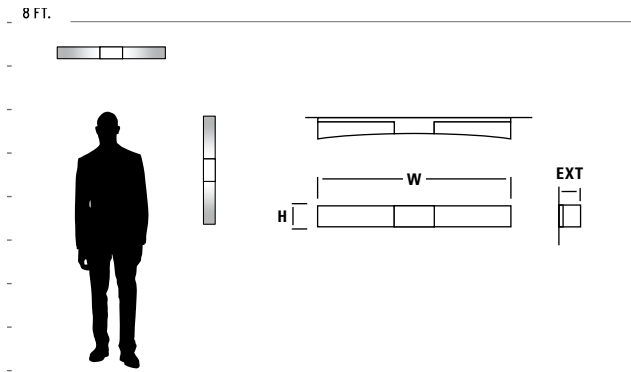

GENERAL SPECIFICATIONS:

- Cold rolled steel housing and trim.
- Diffusers are 1/8" thick matte white acrylic.
- Unit mounts to 2"x3" junction box.
- Approved for horizontal or vertical mounting.
- Approved for wall mount applications only.
- Total luminaire power 25.7w.
- Visit www.oxygenlighting.com for technical cut sheets.
- Oxygen reserves the right to modify designs at any time.

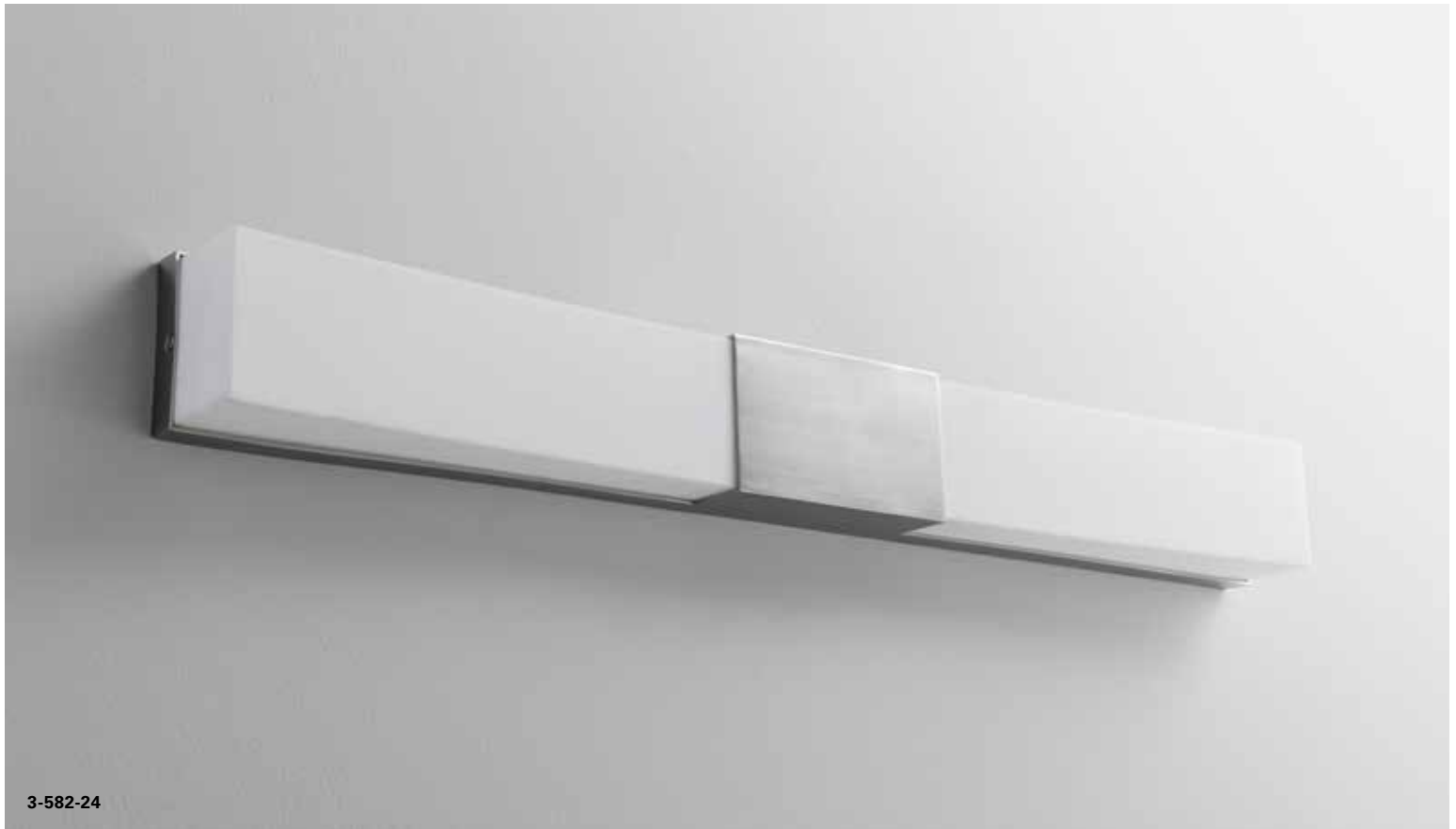

3-582-24







AVAILABLE FINISHES



14 Polished Chrome



24 Satin Nickel

ITEM #	DIFFUSER	FINISH	DIMENSIONS	LAMPING	DRIVER	CERTIFICATION
3-582-XX	Matte White Acrylic	14 Polished Chrome 24 Satin Nickel	30.5"(w) x 3.5"(h) x 3"(ext)	2 x 10.1w, 90CRI 3000k LED	120V 0-10V/Phase dimming	  
37-582-XX	Matte White Acrylic	14 Polished Chrome 24 Satin Nickel	30.5"(w) x 3.5"(h) x 3"(ext)	2 x 10.1w, 90CRI 3000k LED	277V 0-10V/Phase dimming	  

2700k, 3500k, 4000k color temperatures also available. Contact Oxygen for ordering information.

FUSE VANITY

ADA

LED

FLOURESCENT

ENERGY STAR



3-544-24

FUSE VANITY

8 FT.

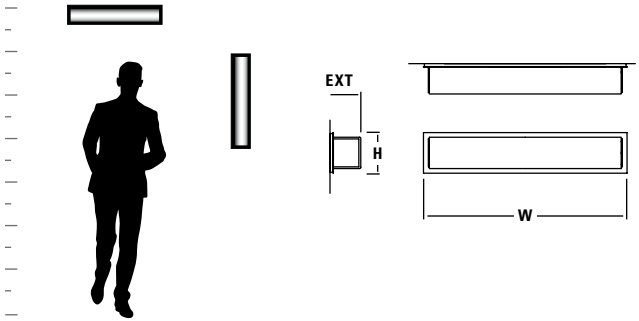

GENERAL SPECIFICATIONS:

- Cold rolled steel housing.
- Machined steel end caps.
- Acrylic diffusers are formed, 1/8" thick matte white acrylic.
- Unit mounts to 4" octagonal junction box, with additional holes provided to mount direct to structure.
- Approved for wall mount application only.
- Toolless access to lamps for fluorescent model.
- Approved for vertical or horizontal mounting.
- Total luminaire power 26.2w for LED models.
- Visit www.oxygenlighting.com for technical cut sheets.
- Oxygen reserves the right to modify designs at any time.



2-5134-24



3-544-24

AVAILABLE FINISH



24 Satin Nickel

ITEM #	DIFFUSER	FINISH	DIMENSIONS	LAMPING	BALLAST	DRIVER	CERTIFICATION
2-5134-24	Matte White Acrylic	24 Satin Nickel	26"(w) x 5"(h) x 4"(ext)	2 x 17w T8 fluorescent (medium bi-pin)	Electronic, HPF, Instant Start, Universal Voltage (120V-277V)	--	
3-544-24	Matte White Acrylic	24 Satin Nickel	26"(w) x 5"(h) x 4"(ext)	2 x 10.1w, 90CRI 3000k LED	--	120V 0-10V/Phase dimming	
37-544-24	Matte White Acrylic	24 Satin Nickel	26"(w) x 5"(h) x 4"(ext)	2 x 10.1w, 90CRI 3000k LED	--	277V 0-10V/Phase dimming	

2700k, 3500k, 4000k color temperatures also available for LED models. Contact Oxygen for ordering information.

HORIZON VANITY

LED

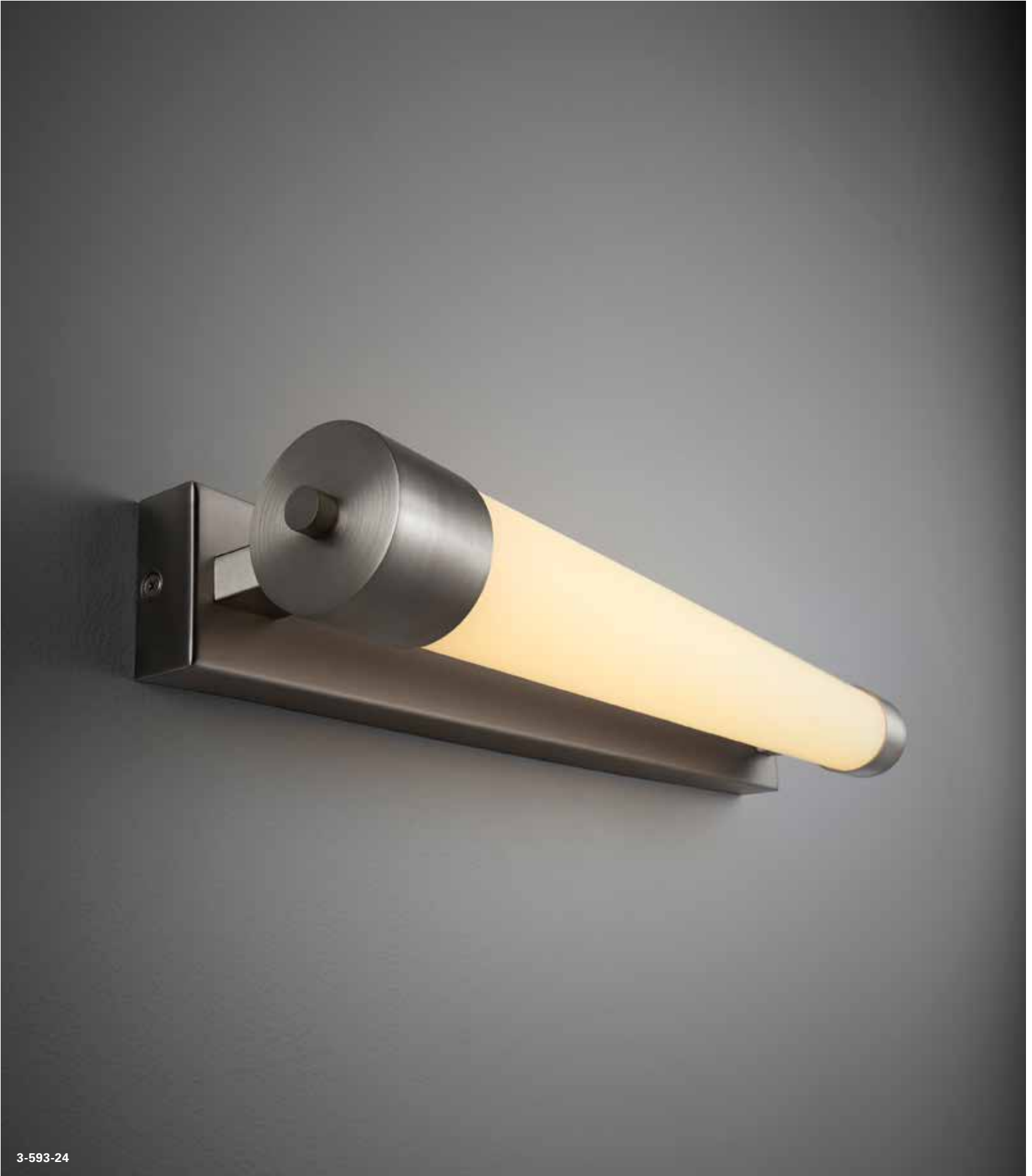

3-593-24

HORIZON VANITY



3-593-14



3-593-24

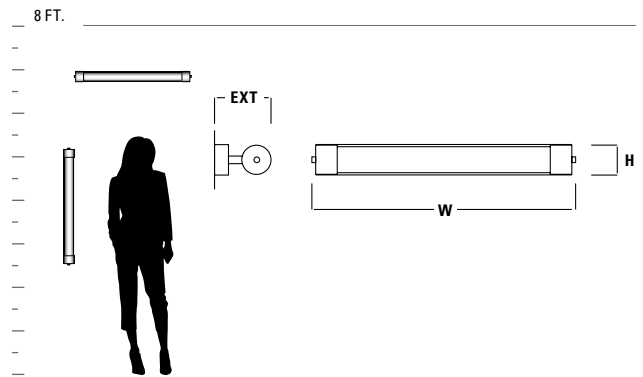

GENERAL SPECIFICATIONS:

- Cold rolled steel housing and trim.
- Diffusers are 1/8" thick matte white acrylic.
- Unit mounts to 2"x3" junction box with additional mounting points direct to structure.
- Allow 6" to either end of fixture to facilitate mounting of back plate.
- Approved for horizontal or vertical mounting.
- Approved for wall mount applications only.
- Total luminaire power 30.8w.
- Visit www.oxygenlighting.com for technical cut sheets.
- Oxygen reserves the right to modify designs at any time.

AVAILABLE FINISHES



14 Polished Chrome



24 Satin Nickel

ITEM #	DIFFUSER	FINISH	DIMENSIONS	LAMPING	DRIVER	CERTIFICATION
3-593-XX	Matte White Acrylic	14 Polished Chrome 24 Satin Nickel	26"(w) x 3"(h) x 5.75"(ext)	1 x 11.6w, 90CRI 3000k LED	120V 0-10V/Phase dimming	ETL US ETL damp
37-593-XX	Matte White Acrylic	14 Polished Chrome 24 Satin Nickel	26"(w) x 3"(h) x 5.75"(ext)	1 x 11.6w, 90CRI 3000k LED	277V 0-10V/Phase dimming	ETL US ETL damp

2700k, 3500k, 4000k color temperatures also available. Contact Oxygen for ordering information.

MAGNETA VANITY

ADA

LED



3-590-24

MAGNETA VANITY

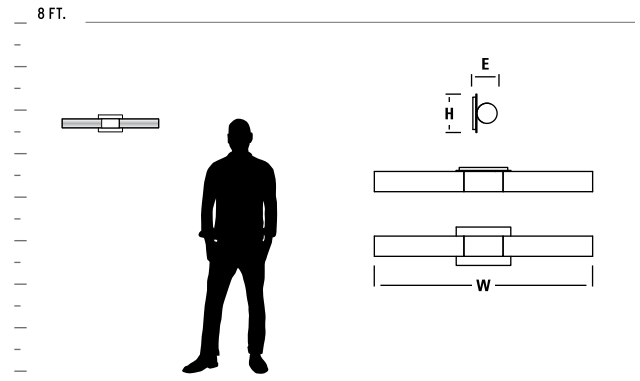
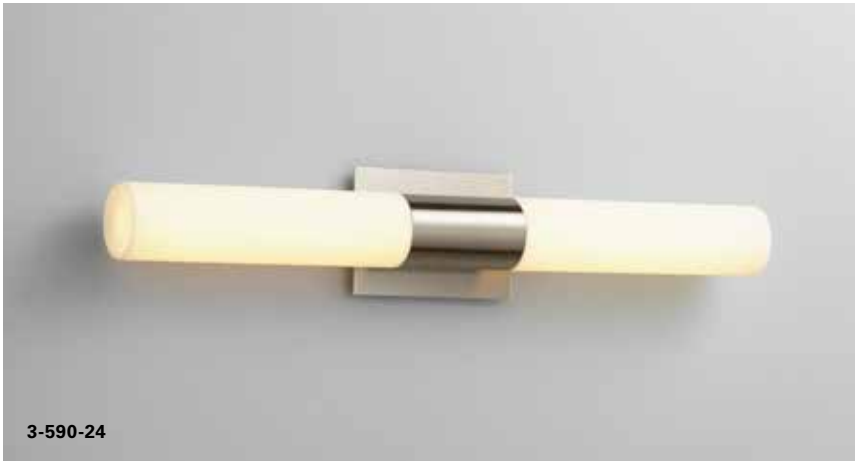
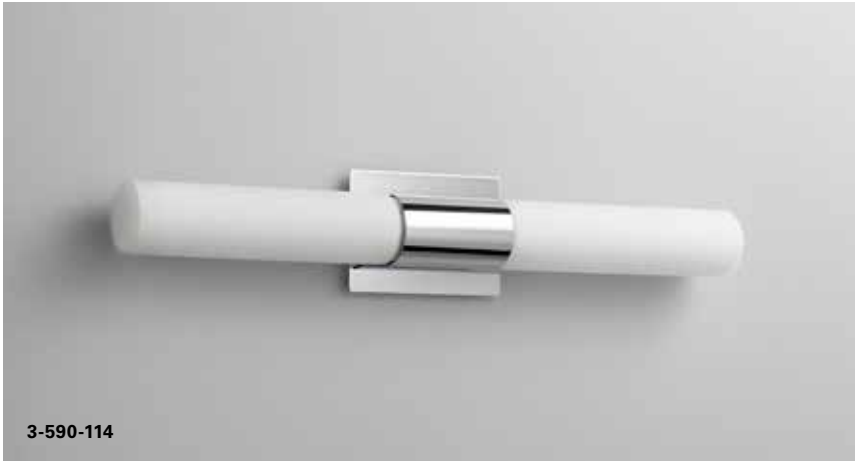

GENERAL SPECIFICATIONS:

- Aluminum housing.
- Diffuser is 1/8" thick matte white acrylic or matte opal glass.
- Installs on 4" octagonal junction box.
- Approved for wall mount application only.
- Closed ends.
- Approved for vertical or horizontal mounting.
- Total luminaire power 29w.
- Visit www.oxygenlighting.com for technical cut sheets.
- Oxygen reserves the right to modify designs at any time.

AVAILABLE FINISHES

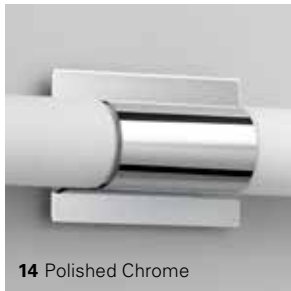

ITEM #	DIFFUSER	FINISH	DIMENSIONS	LAMPING	DRIVER	CERTIFICATION
3-590-XX	Matte White Acrylic	14 Polished Chrome 24 Satin Nickel 40 Aged Brass	27"(w) x 4.75"(h) x 3.375"(ext)	2 x 11.9w, 90CRI 3000k LED	120V 0-10V/Phase dimming	ADA ETL ETL
37-590-XX	Matte White Acrylic	14 Polished Chrome 24 Satin Nickel 40 Aged Brass	27"(w) x 4.75"(h) x 3.375"(ext)	2 x 11.9w, 90CRI 3000k LED	277V 0-10V/Phase dimming	ADA ETL ETL
3-590-1XX	1 Matte Opal Glass	14 Polished Chrome 24 Satin Nickel 40 Aged Brass	27"(w) x 4.75"(h) x 3.375"(ext)	2 x 11.9w, 90CRI 3000k LED	120V 0-10V/Phase dimming	ADA ETL ETL
37-590-1XX	1 Matte Opal Glass	14 Polished Chrome 24 Satin Nickel 40 Aged Brass	27"(w) x 4.75"(h) x 3.375"(ext)	2 x 11.9w90CRI 3000k LED	277V 0-10V/Phase dimming	ADA ETL ETL

2700k, 3500k, 4000k color temperatures also available. Contact Oxygen for ordering information.

MAGNUM VANITY

ADA

LED



3-588-140

MAGNUM VANITY

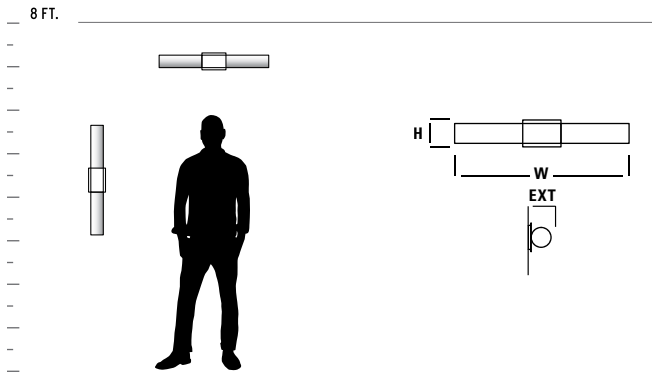

GENERAL SPECIFICATIONS:

- Aluminum housing.
- Diffuser is 1/8" thick matte white acrylic or matte opal glass.
- Installs on 4" octagonal junction box.
- Approved for wall mount application only.
- Closed ends.
- Approved for vertical or horizontal mounting.
- Total luminaire power 30.5w.
- Visit www.oxygenlighting.com for technical cut sheets.
- Oxygen reserves the right to modify designs at any time.

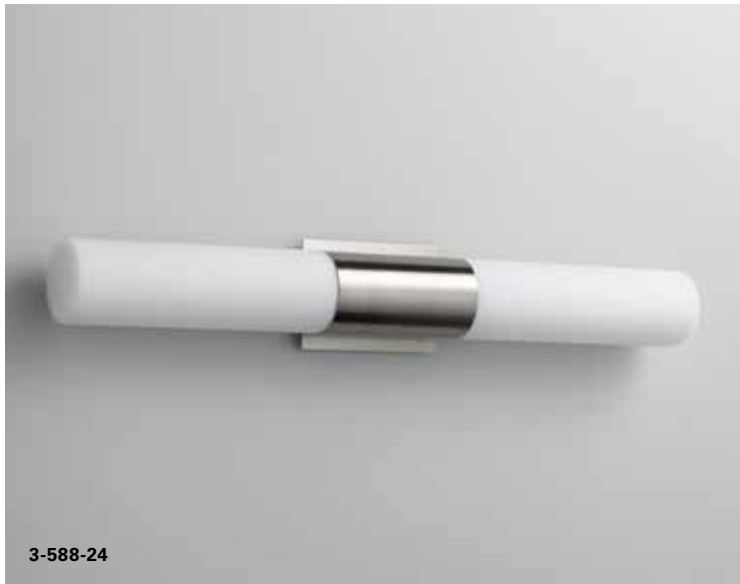

AVAILABLE FINISHES



ITEM #	DIFFUSER	FINISH	DIMENSIONS	LAMPING	DRIVER	CERTIFICATION
3-588-XX	Matte White Acrylic	14 Polished Chrome 24 Satin Nickel 25 Satin Copper 40 Aged Brass	30.75"(w) x 4.75"(h) x 4"(ext)	2 x 11.9w, 90CRI 3000k LED	120V 0-10V/Phase dimming available	
37-588-XX	Matte White Acrylic	14 Polished Chrome 24 Satin Nickel 25 Satin Copper 40 Aged Brass	30.75"(w) x 4.75"(h) x 4"(ext)	2 x 11.9w, 90CRI 3000k LED	277V 0-10V/Phase dimming available	
3-588-1XX	1 Matte Opal Glass	14 Polished Chrome 24 Satin Nickel 25 Satin Copper 40 Aged Brass	30.75"(w) x 4.75"(h) x 4"(ext)	2 x 11.9w, 90CRI 3000k LED	120V 0-10V/Phase dimming available	
37-588-1XX	1 Matte Opal Glass	14 Polished Chrome 24 Satin Nickel 25 Satin Copper 40 Aged Brass	30.75"(w) x 4.75"(h) x 4"(ext)	2 x 11.9w, 90CRI 3000k LED	277V 0-10V/Phase dimming available	

2700k, 3500k, 4000k color temperatures also available. Contact Oxygen for ordering information.

METRIX VANITY

ADA

LED



3-542-24

METRIX VANITY



3-542-20



3-542-20

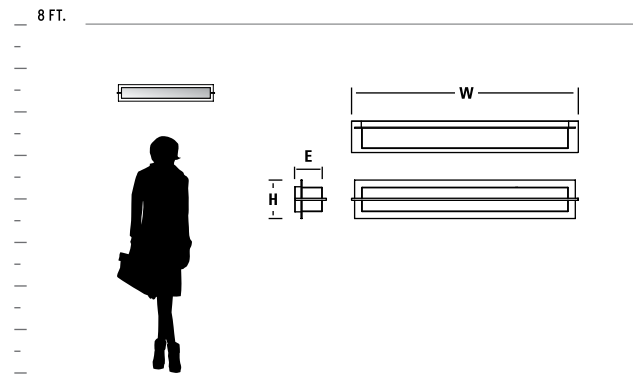

GENERAL SPECIFICATIONS:

- Cold-rolled steel housing.
- Diffuser is 1/8" thick matte white acrylic.
- Unit mounts to 2"x3" junction box.
- Approved for vertical or horizontal mounting.
- Approved for wall or ceiling mount applications
- Total luminaire power 14.6w.
- Visit www.oxygenlighting.com for technical cut sheets.
- Oxygen reserves the right to modify designs at any time.

AVAILABLE FINISHES



20 Polished Nickel



24 Satin Nickel

ITEM #	DIFFUSER	FINISH	DIMENSIONS	LAMPING	DRIVER	CERTIFICATION
3-542-XX	Matte White Acrylic	20 Polished Nickel 24 Satin Nickel	28"(w) x 4.75"(h) x 3.875"(ext)	1 x 11.9w, 90CRI 3000k LED	120V 0-10V/Phase dimming	
37-542-XX	Matte White Acrylic	20 Polished Nickel 24 Satin Nickel	28"(w) x 4.75"(h) x 3.875"(ext)	1 x 11.9w, 90CRI 3000k LED	277V 0-10V/Phase dimming	

2700k, 3500k, 4000k color temperatures also available. Contact Oxygen for ordering information.

PEBBLE VANITY

ADA

INCANDESCENT



2-5121-124

PEBBLE VANITY

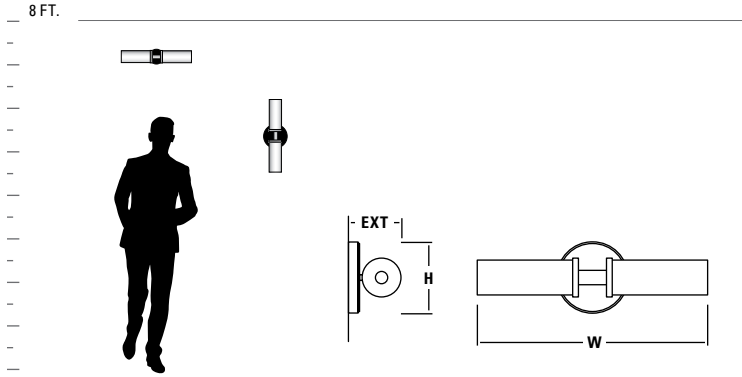

GENERAL SPECIFICATIONS:

- Cast and machined steel fittings.
- Diffusers thread onto housing with integral threaded fitting.
- Diffusers are 1/4" thick white opal duplex glass.
- Unit mounts to 4" octagonal junction box.
- Approved for wall mount application only.
- Approved for vertical or horizontal mounting.
- Open ends.
- Visit www.oxygenlighting.com for technical cut sheets.
- Oxygen reserves the right to modify designs at any time.



AVAILABLE FINISHES



ITEM #	DIFFUSER	FINISH	DIMENSIONS	LAMPING	CERTIFICATION
2-5121-1XX	1 White Opal Glass	14 Polished Chrome 24 Satin Nickel	20.5"(w) x 4.25"(h) x 4"(ext)	2 x 60w T10 120V incandescent (medium base)	

PLATO VANITY

ADA

LED



3-534-24

PLATO VANITY



3-534-20



3-534-24

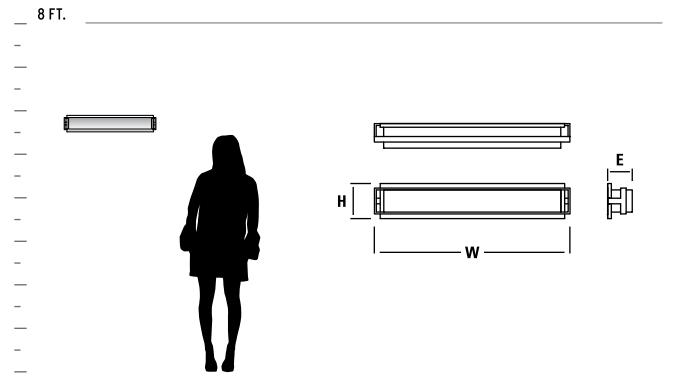

GENERAL SPECIFICATIONS:

- Cold-rolled steel housing. • Diffuser is 1/8" thick matte white acrylic.
- Unit mounts to 2"x3" junction box. • Approved for vertical or horizontal mounting.
- Approved for wall mount application only. • Total luminaire power 14.9w. • Visit www.oxygenlighting.com for technical cut sheets.
- Oxygen reserves the right to modify designs at any time.

AVAILABLE FINISHES



20 Polished Nickel



24 Satin Nickel

ITEM #	DIFFUSER	FINISH	DIMENSIONS	LAMPING	DRIVER	CERTIFICATION
3-534-XX	Matte White Acrylic	20 Polished Nickel 24 Satin Nickel	26.5"(w) x 4.75"(h) x 3.375"(ext)	1 x 11.6w, 90CRI 3000k LED	120V 0-10V/Phase dimming	
37-534-XX	Matte White Acrylic	20 Polished Nickel 24 Satin Nickel	26.5"(w) x 4.75"(h) x 3.375"(ext)	1 x 11.6w, 90CRI 3000k LED	277V 0-10V/Phase dimming	

2700k, 3500k, 4000k color temperatures also available. Contact Oxygen for ordering information.

SKYLINE VANITY

ADA

FLOURESCENT



SKYLINE VANITY



2-5131-24

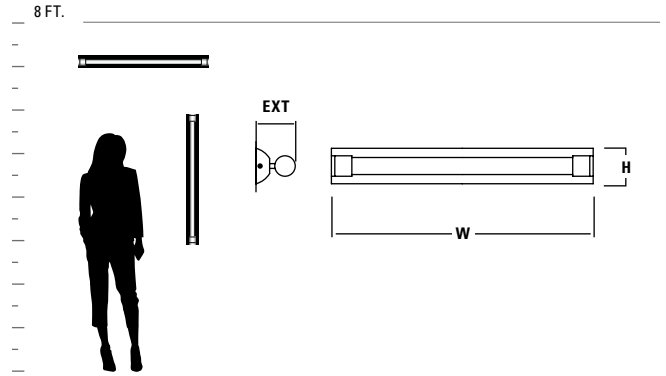

GENERAL SPECIFICATIONS:

- Cold rolled steel housing. • Cast steel end caps. • Acrylic diffusers are extruded, 1/8" thick matte white acrylic. • Unit mounts to 2"x3" junction box, with additional holes for mounting direct to structure. • Approved for vertical or horizontal mounting. • Approved for wall mount application only. • Allow 6" to either end of fixture to facilitate mounting of back plate. • Toolless access to lamp. • Visit www.oxygenlighting.com for technical cut sheets. • Oxygen reserves the right to modify designs at any time.



2-5132-14

AVAILABLE FINISHES



14 Polished Chrome



24 Satin Nickel

ITEM #	DIFFUSER	FINISH	DIMENSIONS	LAMPING	BALLAST	CERTIFICATION
2-5131-XX small	Matte White Acrylic	14 Polished Chrome 24 Satin Nickel	24"(w) x 3.25"(h) x 4"(ext)	1 x 14w T5 fluorescent (mini bi-pin)	Electronic, HPF, Programmed Start, Universal Voltage (120V - 277V)	
2-5132-XX medium	Matte White Acrylic	14 Polished Chrome 24 Satin Nickel	36"(w) x 3.25"(h) x 4"(ext)	1 x 21w T5 fluorescent (mini bi-pin)	Electronic, HPF, Programmed Start, Universal Voltage (120V - 277V)	

ZENITH VANITY

ADA

FLOURESCENT



2-5169-14

2-5169-24

ZENITH VANITY

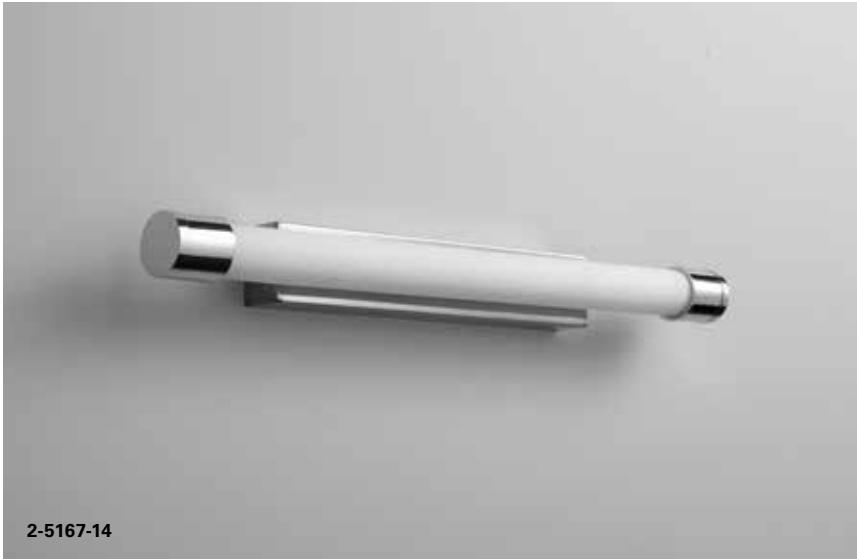

2-5167-14



PROFILE

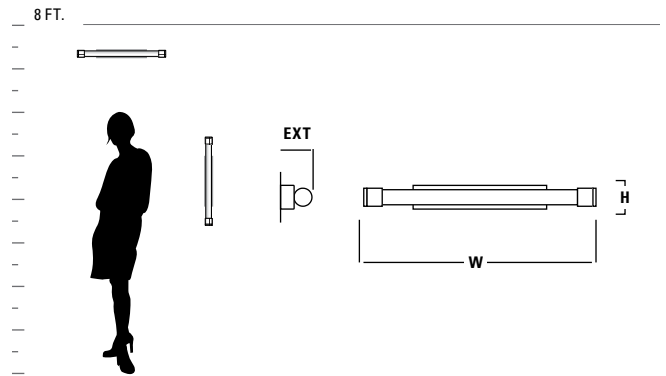

2-5167-24

GENERAL SPECIFICATIONS:

- Cold rolled steel housing. • Cast steel end caps. • Diffusers are 1/8" thick extruded matte white acrylic. • Units mounts to 2"x3" junction box. • Toolless access to lamp • Approved for vertical or horizontal mounting. • Approved for wall mount application only.
- Visit www.oxygenlighting.com for technical cut sheets.
- Oxygen reserves the right to modify designs at any time.

AVAILABLE FINISHES

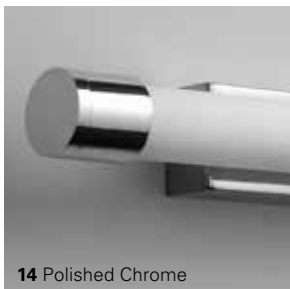

14 Polished Chrome



24 Satin Nickel

ITEM #	DIFFUSER	FINISH	DIMENSIONS	LAMPING	BALLAST	CERTIFICATION
2-5167-XX small	Matte White Acrylic	14 Polished Chrome 24 Satin Nickel	24.25"(w) x 2.5"(h) x 3.25"(ext)	1 x 14w T5 fluorescent (mini bi-pin)	Electronic, HPF, Programmed Start, Universal Voltage (120V - 277V)	
2-5169-XX large	Matte White Acrylic	14 Polished Chrome 24 Satin Nickel	47.75"(w) x 2.5"(h) x 3.25"(ext)	1 x 28w T5 fluorescent (mini bi-pin)	Electronic, HPF, Programmed Start, Universal Voltage (120V - 277V)	

ZENITH II VANITY

ADA

LED



3-557-14

ZENITH II VANITY



PROFILE

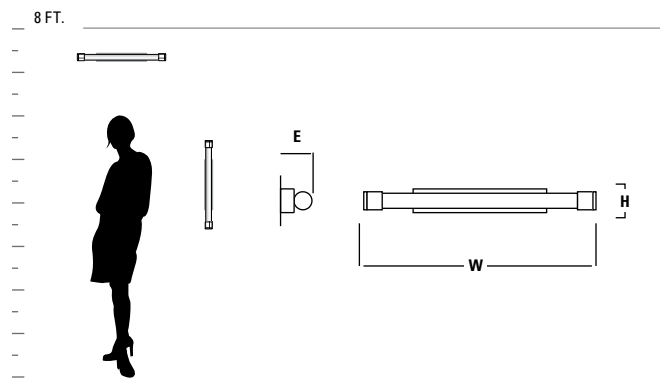

GENERAL SPECIFICATIONS:

- Cold-rolled steel housing. • Diffuser is 1/8" thick matte white acrylic. • Unit mounts to 2"x3" junction box. • Approved for vertical or horizontal mounting. • Approved for wall mount application only.
- Total luminaire power 14.5w for 3-557-XX/37-557-XX and 29.4w for 3-559-XX/37-559-XX. • Visit www.oxygenlighting.com for technical cut sheets. • Oxygen reserves the right to modify designs at any time.

AVAILABLE FINISHES



ITEM #	DIFFUSER	FINISH	DIMENSIONS	LAMPING	DRIVER	CERTIFICATION
3-557-XX small	Matte White Acrylic	14 Polished Chrome 22 Oiled Bronze 24 Satin Nickel 40 Aged Brass	24.25"(w) x 2.5"(h) x 3.25"(ext)	1 x 11.6w, 90CRI 3000k LED	120V 0-10V/Phase dimming	ADA COMPLIANT, ETL US, ETL damp
37-557-XX small	Matte White Acrylic	14 Polished Chrome 22 Oiled Bronze 24 Satin Nickel 40 Aged Brass	24.25"(w) x 2.5"(h) x 3.25"(ext)	1 x 11.6w, 90CRI 3000k LED	277V 0-10V/Phase dimming	ADA COMPLIANT, ETL US, ETL damp
3-559-XX large	Matte White Acrylic	14 Polished Chrome 22 Oiled Bronze 24 Satin Nickel 40 Aged Brass	47.75"(w) x 2.5"(h) x 3.25"(ext)	2 x 11.6w, 90CRI 3000k LED	120V 0-10V/Phase dimming	ADA COMPLIANT, ETL US, ETL damp
37-559-XX large	Matte White Acrylic	14 Polished Chrome 22 Oiled Bronze 24 Satin Nickel 40 Aged Brass	47.75"(w) x 2.5"(h) x 3.25"(ext)	2 x 11.6w, 90CRI 3000k LED	277V 0-10V/Phase dimming	ADA COMPLIANT, ETL US, ETL damp

2700k, 3500k, 4000k color temperatures also available. Contact Oxygen for ordering information.



ceiling mounts

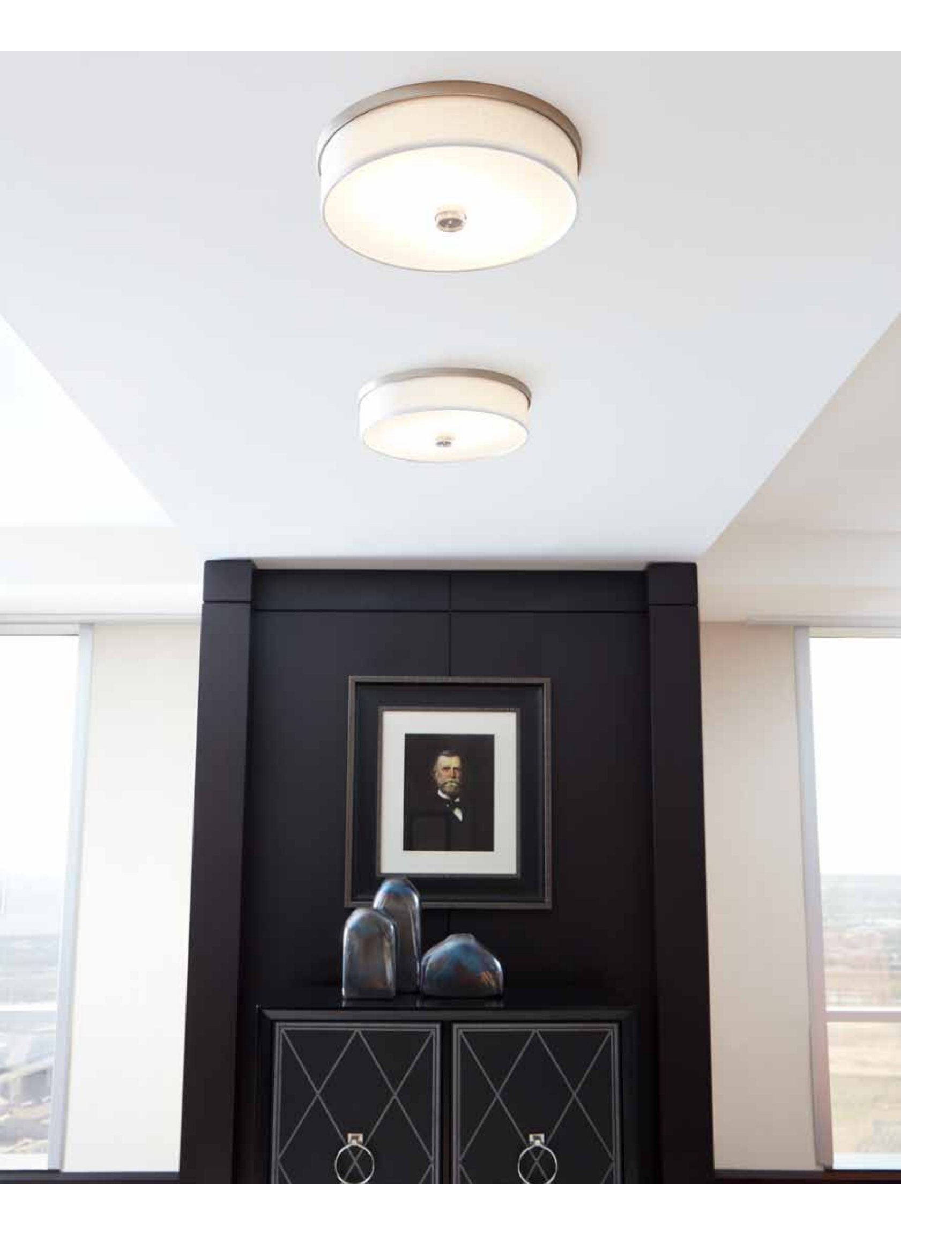

DIONE CEILING MOUNT

ADA

LED

EM



32-664-24

DIONE CEILING MOUNT

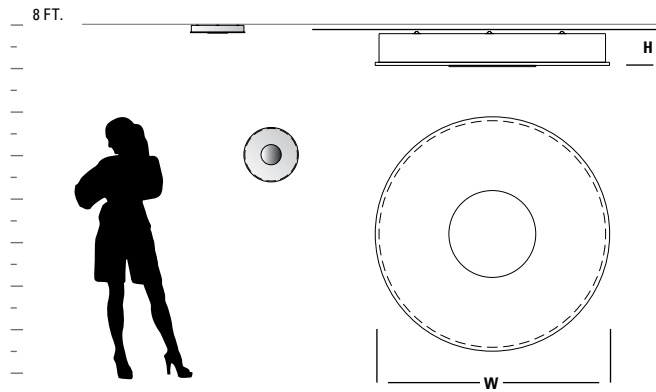

GENERAL SPECIFICATIONS:

- Spun steel housing. • 1/8" frost white glass diffuser. • Units mount to 4" octagonal junction box.
- Approved for wall or ceiling mount applications. • Total luminaire power 11.2w for 32-664-24 and 23.5w for 32-665-24. • Visit www.oxygenlighting.com for technical cut sheets. • Oxygen reserves the right to modify designs at any time.

EMERGENCY BATTERY BACKUP MODELS (EM)

- ETL required 90 minute emergency battery run time • 32 hour recharge time.

AVAILABLE FINISH



24 Satin Nickel

ITEM #	DIFFUSER	FINISH	DIMENSIONS	LAMPING	DRIVER	CERTIFICATION
32-664-24 small	Frosted Glass	24 Satin Nickel	15"(w) x 2.25"(h)	1 x 9.9w, 90CRI 3000k LED	120/277V 0-10V dimming	
32-665-24 large	Frosted Glass	24 Satin Nickel	21"(w) x 2.25"(h)	1 x 20.7w, 90CRI 3000k LED	120/277V 0-10V dimming	
32-665-24-EM large	Frosted Glass	24 Satin Nickel	21"(w) x 2.25"(h)	1 x 20.7w, 90CRI 3000k LED	120/277V 0-10V dimming	

2700k, 3500k, 4000k color temperatures also available for non EM LED models. Contact Oxygen for ordering information.

ECHO CEILING MOUNT

LED

EM



3-694-24

ECHO CEILING MOUNT



3-694-24



3-695-24

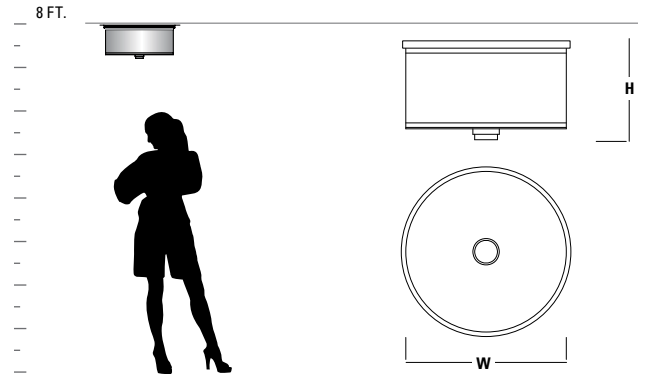

GENERAL SPECIFICATIONS:

- Cold rolled steel housing. • Grass shades are natural bamboo fibers.
- White acrylic diffuser is 1/8" thick. • Cast steel with acrylic finial.
- Unit mounts to 4" octagonal junction box. • Approved for ceiling mount applications only. • Total luminaire power 27.5w for 3-694-24/37-694-24 and 26.6w for 3-695-XX/37-695-XX. • Visit www.oxygenlighting.com for technical cut sheets. • Oxygen reserves the right to modify designs at any time.

EMERGENCY BATTERY BACKUP MODELS (EM)

- ETL required 90 minute emergency battery run time • 32 hour recharge time.

AVAILABLE FINISHES



22 Oiled Bronze



24 Satin Nickel

ITEM #	DIFFUSER	FINISH	DIMENSIONS	LAMPING	DRIVER	CERTIFICATION
3-694-24	Grass Shade With White Acrylic	24 Satin Nickel	14.5"(w) x 4"(h)	2 x 10.1w, 90CRI 3000k LED	120V 0-10V/Phase dimming	ETL US
37-694-24	Grass Shade With White Acrylic	24 Satin Nickel	14.5"(w) x 4"(h)	2 x 10.1w, 90CRI 3000k LED	277V 0-10V/Phase dimming	ETL US
3-694-24-EM	Grass Shade With White Acrylic	24 Satin Nickel	14.5"(w) x 4"(h)	2 x 10.1w, 90CRI 3000k LED	120V 0-10V/Phase dimming	ETL US EM
37-694-24-EM	Grass Shade With White Acrylic	24 Satin Nickel	14.5"(w) x 4"(h)	2 x 10.1w, 90CRI 3000k LED	277V 0-10V/Phase dimming	ETL US EM
3-695-XX	Grass Shade With White Acrylic	22 Oiled Bronze 24 Satin Nickel	14.5"(w) x 7.75"(h)	2 x 10.1w, 90CRI 3000k LED	120V 0-10V/Phase dimming	ETL US
37-695-XX	Grass Shade With White Acrylic	22 Oiled Bronze 24 Satin Nickel	14.5"(w) x 7.75"(h)	2 x 10.1w, 90CRI 3000k LED	277V 0-10V/Phase dimming	ETL US
3-695-XX-EM	Grass Shade With White Acrylic	22 Oiled Bronze 24 Satin Nickel	14.5"(w) x 7.75"(h)	2 x 10.1w, 90CRI 3000k LED	120V 0-10V/Phase dimming	ETL US EM
37-695-XX-EM	Grass Shade With White Acrylic	22 Oiled Bronze 24 Satin Nickel	14.5"(w) x 7.75"(h)	2 x 10.1w, 90CRI 3000k LED	277V 0-10V/Phase dimming	ETL US EM

2700k, 3500k, 4000k color temperatures also available for non EM LED models. Contact Oxygen for ordering information.

ELLIPSE CEILING MOUNT

LED



3-354-120

ELLIPSE CEILING MOUNT

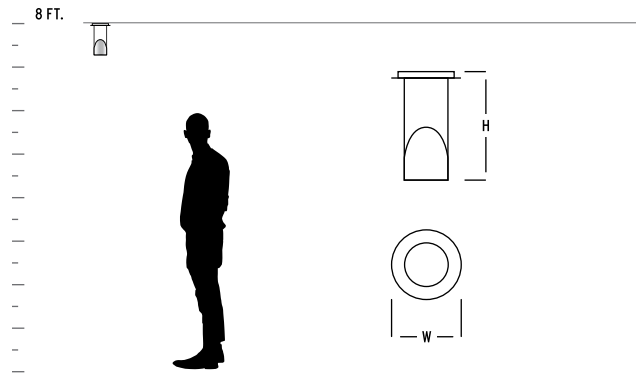

GENERAL SPECIFICATIONS:

- Cold rolled steel housing. • White acrylic diffuser is 1/16" thick. • Glass diffuser is 1/8" matte opal • Models 3-353-XXX/37-353-XXX has 2.75" dia diffuser • Models 3-354-XXX/37-354-XXX has 3.5" dia diffuser
- Unit mounts to 4" octagonal or 2"x3" junction box. • Driver mounts inside junction box. • Unit requires 2.5" deep junction box. • Approved for ceiling and wall mounted applications. • Total luminaire power 6.8w.
- Visit www.oxygenlighting.com for technical cut sheets. • Oxygen reserves the right to modify designs at any time.

AVAILABLE FINISHES



ITEM #	DIFFUSER	FINISH	DIMENSIONS	LAMPING	DRIVER	CERTIFICATION
3-353-XXX	1 Matte Opal Glass 2 Matte White Acrylic	15 Black 20 Polished Nickel 24 Satin Nickel	5.875" (w) x 9.25" (h)	1 x 5.1w, 90CRI 3000k LED	120V 0-10V/Phase dimming	
37-353-XXX	1 Matte Opal Glass 2 Matte White Acrylic	15 Black 20 Polished Nickel 24 Satin Nickel	5.875" (w) x 9.25" (h)	1 x 5.1w, 90CRI 3000k LED	277V 0-10V/Phase dimming	
3-354-XXX	1 Matte Opal Glass 2 Matte White Acrylic	15 Black 20 Polished Nickel 24 Satin Nickel	5.875" (w) x 9.25" (h)	1 x 5.1w, 90CRI 3000k LED	120V 0-10V/Phase dimming	
37-354-XXX	1 Matte Opal Glass 2 Matte White Acrylic	15 Black 20 Polished Nickel 24 Satin Nickel	5.875" (w) x 9.25" (h)	1 x 5.1w, 90CRI 3000k LED	227V 0-10V/Phase dimming	

2700k, 3500k, 4000k color temperatures also available. Contact Oxygen for ordering information.

IO CEILING MOUNT

LED

EM



3-689-24

IO CEILING MOUNT

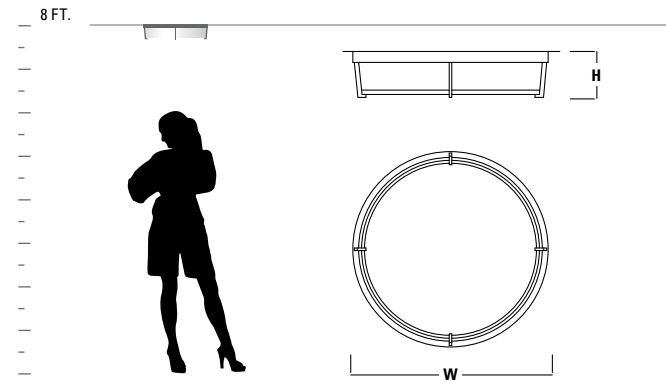

GENERAL SPECIFICATIONS:

- Cold rolled steel housing.
- Matte white acrylic is formed 1/16" thick.
- Unit mounts to 4" octagonal junction box.
- Toolless access to lamp for fluorescent model.
- Approved for ceiling mount applications only.
- Total luminaire power 25.6w for LED models.
- Visit www.oxygenlighting.com for technical cut sheets.
- Oxygen reserves the right to modify designs at any time.

EMERGENCY BATTERY BACKUP MODELS (EM)

- ETL required 90 minute emergency battery run time • 32 hour recharge time.

AVAILABLE FINISHES



ITEM #	DIFFUSER	FINISH	DIMENSIONS	LAMPING	BALLAST	DRIVER	CERTIFICATION
2-699-24	Matte White Acrylic	24 Satin Nickel	17"(w) x 4 "(h)	22w + 40w T5 circline fluorescent (2GX13)	Electronic, HPF, Programmed Start, Universal Voltage (120-277V)	--	
3-689-XX	Matte White Acrylic	24 Satin Nickel 40 Aged Brass	17"(w) x 4 "(h)	2 x 10.1w, 90CRI 3000k LED	--	120V 0-10V/Phase dimming	
37-689-XX	Matte White Acrylic	24 Satin Nickel 40 Aged Brass	17"(w) x 4 "(h)	2 x 10.1w, 90CRI 3000k LED	--	277V 0-10V/Phase dimming	
3-689-XX-EM	Matte White Acrylic	24 Satin Nickel 40 Aged Brass	17"(w) x 4 "(h)	2 x 10.1w, 90CRI 3000k LED	--	120V 0-10V/Phase dimming	
37-689-XX-EM	Matte White Acrylic	24 Satin Nickel 40 Aged Brass	17"(w) x 4 "(h)	2 x 10.1w, 90CRI 3000k LED	--	277V 0-10V/Phase dimming	

2700k, 3500k, 4000k color temperatures also available for non EM LED models. Contact Oxygen for ordering information.

JOURNEY CEILING MOUNT

FLOURESCENT



2-6135-24

JOURNEY CEILING MOUNT

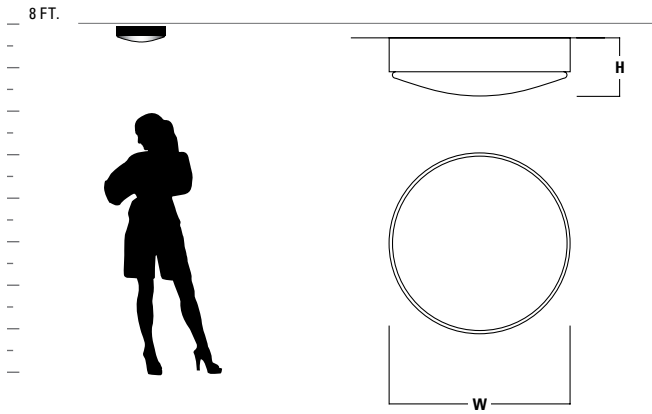





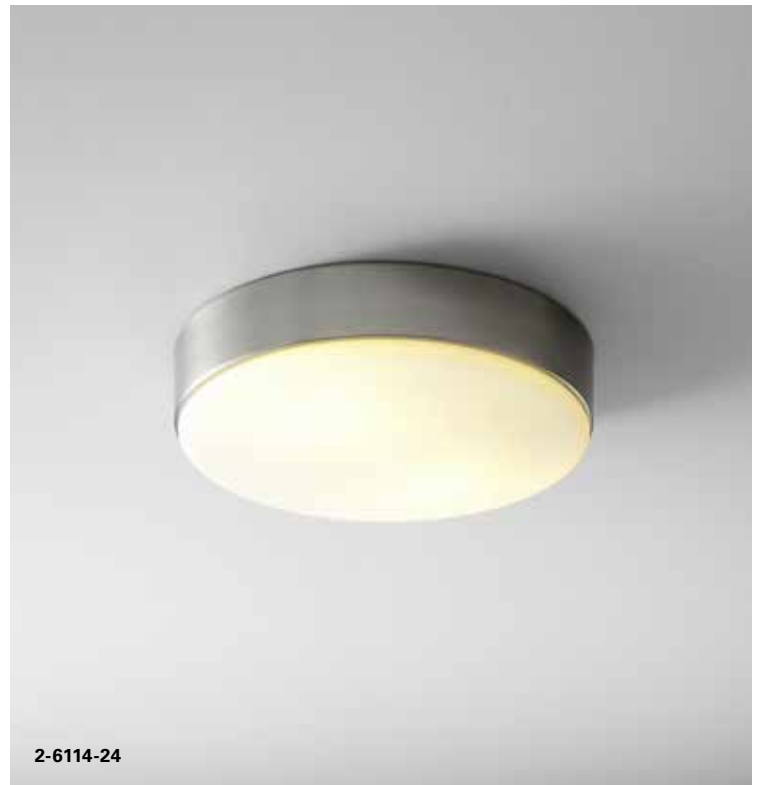

GENERAL SPECIFICATIONS:

- Spun steel housing.
- Matte white acrylic is formed 1/16" thick.
- Opal glass diffuser is 1/8" thick.
- Unit mounts to 4" octagonal junction box.
- Approved for ceiling mount applications only.
- Toolless access to lamp.
- Visit www.oxygenlighting.com for technical cut sheets.
- Oxygen reserves the right to modify designs at any time.



AVAILABLE FINISH



ITEM #	DIFFUSER	FINISH	DIMENSIONS	LAMPING	BALLAST	CERTIFICATION
2-6114-24 medium	Matte Opal Glass	24 Satin Nickel	14"(w) x 4.5"(h)	2 x 26w quad 4-pin fluorescent (G24q-3)	Electronic, HPF, Programmed Start, Universal Voltage (120-277V)	 
2-6134-24 small	Matte Opal Glass	24 Satin Nickel	11"(w) x 3.5"(h)	2 x 13w quad 4-pin fluorescent (G24q-1)	Electronic, HPF, Programmed Start, Universal Voltage (120-277V)	 
2-6135-24 medium	Matte White Acrylic	24 Satin Nickel	14"(w) x 4.5"(h)	2 x 26w quad 4-pin fluorescent (G24q-3)	Electronic, HPF, Programmed Start, Universal Voltage (120-277V)	 

JOURNEY CEILING MOUNT

LED

ENERGY STAR



3-624-14

JOURNEY CEILING MOUNT

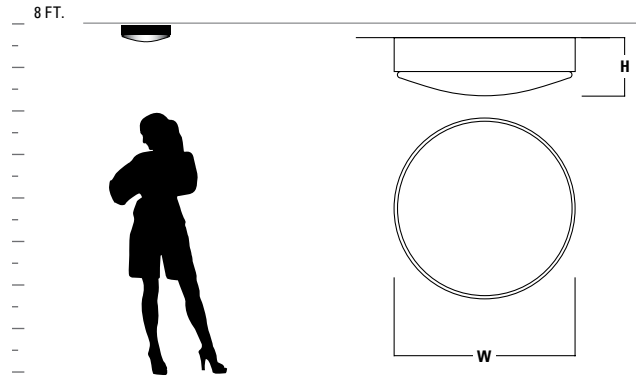

GENERAL SPECIFICATIONS:

- Spun steel housing. • Matte white acrylic is 1/16" thick. • Opal glass diffuser is 1/8" thick. • Unit mounts to 4" octagonal junction box. • Approved for ceiling mount applications only. • Total luminaire power 10.1w for 3-622-24/37-622-24, 10.1w for 3-623-XX/37-623-xx, 25.7w for 3-624-XX/37-624-XX, 12.9w for 3-625-24/37-625-24, and 25.9w for 3-626-XX/37-626-XX. • Visit www.oxygenlighting.com for technical cut sheets. • Oxygen reserves the right to modify designs at any time.

AVAILABLE FINISHES



14 Polished Chrome



24 Satin Nickel

ITEM #	DIFFUSER	FINISH	DIMENSIONS	LAMPING	DRIVER	CERTIFICATION
3-622-24 small	Matte Opal Glass	24 Satin Nickel	11"(w) x 4.5"(h)	1 x 8.2w, 90CRI 3000k LED	120V 0-10V/Phase dimming	ETL _{us} ETL _{damp} ENERGY STAR
37-622-24 small	Matte Opal Glass	24 Satin Nickel	11"(w) x 4.5"(h)	1 x 8.2w, 90CRI 3000k LED	277V 0-10V/Phase dimming	ETL _{us} ETL _{damp}
3-623-XX medium	Matte Opal Glass	14 Polished Chrome 24 Satin Nickel	14"(w) x 4.5"(h)	1 x 10.1w, 90CRI 3000k LED	120V 0-10V/Phase dimming	ETL _{us} ETL _{damp}
37-623-XX medium	Matte Opal Glass	14 Polished Chrome 24 Satin Nickel	14"(w) x 4.5"(h)	1 x 10.1w, 90CRI 3000k LED	277V 0-10V/Phase dimming	ETL _{us} ETL _{damp}
3-624-XX medium	Matte Opal Glass	14 Polished Chrome 24 Satin Nickel	14"(w) x 4.5"(h)	2 x 10.1w, 90CRI 3000k LED	120V 0-10V/Phase dimming	ETL _{us} ETL _{damp} ENERGY STAR
37-624-XX medium	Matte Opal Glass	14 Polished Chrome 24 Satin Nickel	14"(w) x 4.5"(h)	2 x 10.1w, 90CRI 3000k LED	277V 0-10V/Phase dimming	ETL _{us} ETL _{damp}
3-625-24 medium	Matte White Acrylic	24 Satin Nickel	14"(w) x 4.5"(h)	1 x 10.1w, 90CRI 3000k LED	120V 0-10V/Phase dimming	ETL _{us} ETL _{damp} ENERGY STAR
37-625-24 medium	Matte White Acrylic	24 Satin Nickel	14"(w) x 4.5"(h)	1 x 10.1w, 90CRI 3000k LED	277V 0-10V/Phase dimming	ETL _{us} ETL _{damp}
3-626-XX medium	Matte White Acrylic	14 Polished Chrome 24 Satin Nickel	14"(w) x 4.5"(h)	2 x 10.1w, 90CRI 3000k LED	120V 0-10V/Phase dimming	ETL _{us} ETL _{damp} ENERGY STAR
37-626-XX medium	Matte White Acrylic	14 Polished Chrome 24 Satin Nickel	14"(w) x 4.5"(h)	2 x 10.1w, 90CRI 3000k LED	277V 0-10V/Phase dimming	ETL _{us} ETL _{damp}

2700k, 3500k, 4000k color temperatures also available. Contact Oxygen for ordering information.

JOURNEY CEILING MOUNT

LED

EM



37-623-24-EM

JOURNEY CEILING MOUNT

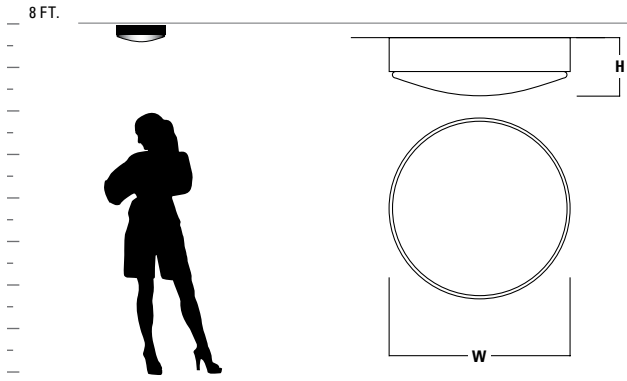

GENERAL SPECIFICATIONS:

- Spun steel housing. • Matte white acrylic is 1/16" thick. • Opal glass diffuser is 1/8" thick.
- Unit mounts to 4" octagonal junction box. • Approved for ceiling mount applications only.
- Total luminaire power 10.1w for 3-623-XX/37-623-xx, 12.9w for 3-625-24/37-625-24.
- Visit www.oxygenlighting.com for technical cut sheets. • Oxygen reserves the right to modify designs at any time.













EMERGENCY BATTERY BACKUP MODELS (EM)

- ETL required 90 minute emergency battery run time • 32 hour recharge time.



AVAILABLE FINISHES



ITEM #	DIFFUSER	FINISH	DIMENSIONS	LAMPING	DRIVER	CERTIFICATION
3-623-XX-EM medium	Matte Opal Glass	14 Polished Chrome 24 Satin Nickel	14"(w) x 4.5"(h)	1 x 10.1w, 90CRI 3000k LED	120V 0-10V/Phase dimming	  
37-623-XX-EM medium	Matte Opal Glass	14 Polished Chrome 24 Satin Nickel	14"(w) x 4.5"(h)	1 x 10.1w, 90CRI 3000k LED	277V 0-10V/Phase dimming	  
3-625-24-EM medium	Matte White Acrylic	24 Satin Nickel	14"(w) x 4.5"(h)	1 x 10.1w, 90CRI 3000k LED	120V 0-10V/Phase dimming	  
37-625-24-EM medium	Matte White Acrylic	24 Satin Nickel	14"(w) x 4.5"(h)	1 x 10.1w, 90CRI 3000k LED	277V 0-10V/Phase dimming	  

MODULO CEILING MOUNT

LED

EM

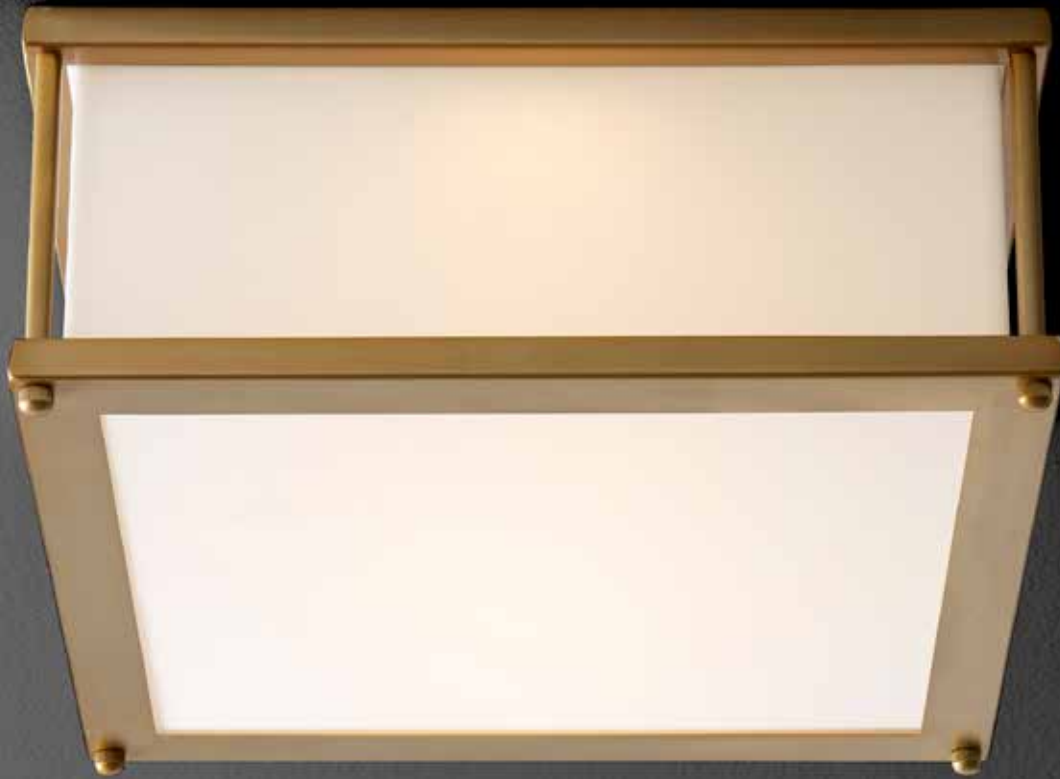

3-682-40

MODULO CEILING MOUNT

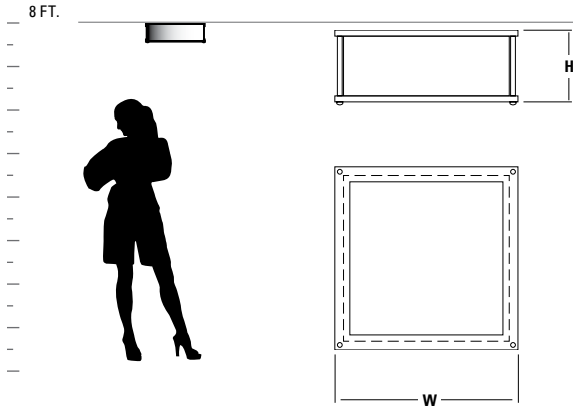

GENERAL SPECIFICATIONS:

- Cold rolled steel housing.
- Matte white acrylic is formed 1/16" thick.
- Unit mounts to 4" octagonal junction box.
- Approved for ceiling mount applications only.
- Total luminaire power 13.2w for 3-682-XX/37-682-XX and 26.2w for 3-683-XX/37-683-XX.
- Visit www.oxygenlighting.com for technical cut sheets.
- Oxygen reserves the right to modify designs at any time.





















EMERGENCY BATTERY BACKUP MODELS (EM)

- ETL required 90 minute emergency battery run time
- 32 hour recharge time.



AVAILABLE FINISHES



ITEM #	DIFFUSER	FINISH	DIMENSIONS	LAMPING	DRIVER	CERTIFICATION
3-682-XX small	Matte White Acrylic	24 Satin Nickel 40 Aged Brass	12"(w) x 4.75"(h)	1 x 10.1w, 90CRI 3000k LED	120V 0-10V/Phase dimming	 
37-682-XX small	Matte White Acrylic	24 Satin Nickel 40 Aged Brass	12"(w) x 4.75"(h)	1 x 10.1w, 90CRI 3000k LED	277V 0-10V/Phase dimming	 
3-682-XX-EM small	Matte White Acrylic	24 Satin Nickel 40 Aged Brass	12"(w) x 4.75"(h)	1 x 10.1w, 90CRI 3000k LED	120V 0-10V/Phase dimming	  
37-682-XX-EM small	Matte White Acrylic	24 Satin Nickel 40 Aged Brass	12"(w) x 4.75"(h)	1 x 10.1w, 90CRI 3000k LED	277V 0-10V/Phase dimming	  
3-683-XX large	Matte White Acrylic	24 Satin Nickel 40 Aged Brass	16"(w) x 4.75"(h)	2 x 10.1w, 90CRI 3000k LED	120V 0-10V/Phase dimming	 
37-683-XX large	Matte White Acrylic	24 Satin Nickel 40 Aged Brass	16"(w) x 4.75"(h)	2 x 10.1w, 90CRI 3000k LED	277V 0-10V/Phase dimming	 
3-683-XX-EM large	Matte White Acrylic	24 Satin Nickel 40 Aged Brass	16"(w) x 4.75"(h)	2 x 10.1w, 90CRI 3000k LED	120V 0-10V/Phase dimming	  
37-683-XX-EM large	Matte White Acrylic	24 Satin Nickel 40 Aged Brass	16"(w) x 4.75"(h)	2 x 10.1w, 90CRI 3000k LED	277V 0-10V/Phase dimming	  

2700k, 3500k, 4000k color temperatures also available for non EM LED models. Contact Oxygen for ordering information.

ORACLE CEILING MOUNT

ADA

LED

ENERGY STAR



3-620-24

ORACLE CEILING MOUNT



3-620-40

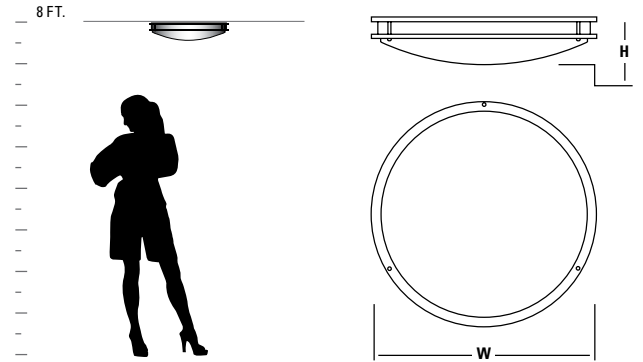

GENERAL SPECIFICATIONS:

- Cold rolled steel housing. • Formed steel trim. • White acrylic diffuser is 1/16" thick. • Unit mounts to 4" octagonal junction box. • Approved for wall or ceiling mount applications. • Total luminaire power 10.4w for 3-618-XX/37-618-XX, 13.2w for 3-619-XX/37-619-XX, and 26.3w for 3-620-XX/37-620-XX. • Visit www.oxygenlighting.com for technical cut sheets. • Oxygen reserves the right to modify designs at any time.

AVAILABLE FINISHES



14 Polished Chrome

22 Oiled Bronze

24 Satin Nickel

40 Aged Brass

ITEM #	DIFFUSER	FINISH	DIMENSIONS	LAMPING	DRIVER	CERTIFICATION
3-618-XX small	Matte White Acrylic	14 Polished Chrome 22 Oiled Bronze 24 Satin Nickel 40 Aged Brass	10.5"(w) x 3.5"(h)	1 x 8.2w, 90CRI 3000k LED	120V 0-10V/Phase dimming	
37-618-XX small	Matte White Acrylic	14 Polished Chrome 22 Oiled Bronze 24 Satin Nickel 40 Aged Brass	10.5"(w) x 3.5"(h)	1 x 8.2w, 90CRI 3000k LED	277V 0-10V/Phase dimming	
3-619-XX medium	Matte White Acrylic	14 Polished Chrome 22 Oiled Bronze 24 Satin Nickel 40 Aged Brass	17.75"(w) x 4.25"(h)	1 x 10.1w, 90CRI 3000k LED	120V 0-10V/Phase dimming	
37-619-XX medium	Matte White Acrylic	14 Polished Chrome 22 Oiled Bronze 24 Satin Nickel 40 Aged Brass	17.75"(w) x 4.25"(h)	1 x 10.1w, 90CRI 3000k LED	277V 0-10V/Phase dimming	
3-620-XX medium	Matte White Acrylic	14 Polished Chrome 22 Oiled Bronze 24 Satin Nickel 40 Aged Brass	17.75"(w) x 4.25"(h)	2 x 10.1w, 90CRI 3000k LED	120V 0-10V/Phase dimming	
37-620-XX medium	Matte White Acrylic	14 Polished Chrome 22 Oiled Bronze 24 Satin Nickel 40 Aged Brass	17.75"(w) x 4.25"(h)	2 x 10.1w, 90CRI 3000k LED	277V 0-10V/Phase dimming	

2700k, 3500k, 4000k color temperatures also available. Contact Oxygen for ordering information.

ORACLE CEILING MOUNT

LED

EM



3-619-40-EM

ORACLE CEILING MOUNT

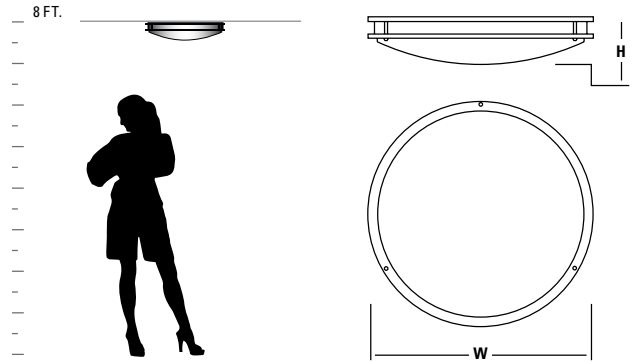

GENERAL SPECIFICATIONS:

- Cold rolled steel housing. • Formed steel trim. • White acrylic diffuser is 1/16" thick. • Unit mounts to 4" octagonal junction box. • Approved for wall or ceiling mount applications. • Total luminaire power 13.2w for 3-619-XX/37-619-XX, and 26.3w for 3-620-XX/37-620-XX. • Visit www.oxygenlighting.com for technical cut sheets. • Oxygen reserves the right to modify designs at any time.

EMERGENCY BATTERY BACKUP MODELS (EM)

- ETL required 90 minute emergency battery run time • 32 hour recharge time.

AVAILABLE FINISHES



ITEM #	DIFFUSER	FINISH	DIMENSIONS	LAMPING	DRIVER	CERTIFICATION
3-619-XX-EM medium	Matte White Acrylic	14 Polished Chrome 22 Oiled Bronze 24 Satin Nickel 40 Aged Brass	17.75"(w) x 4.25"(h)	1 x 10.1w, 90CRI 3000k LED	120V 0-10V/Phase dimming	
37-619-XX-EM medium	Matte White Acrylic	14 Polished Chrome 22 Oiled Bronze 24 Satin Nickel 40 Aged Brass	17.75"(w) x 4.25"(h)	1 x 10.1w, 90CRI 3000k LED	277V 0-10V/Phase dimming	
3-620-XX-EM medium	Matte White Acrylic	14 Polished Chrome 22 Oiled Bronze 24 Satin Nickel 40 Aged Brass	17.75"(w) x 4.25"(h)	2 x 10.1w, 90CRI 3000k LED	120V 0-10V/Phase dimming	
37-620-XX-EM medium	Matte White Acrylic	14 Polished Chrome 22 Oiled Bronze 24 Satin Nickel 40 Aged Brass	17.75"(w) x 4.25"(h)	2 x 10.1w, 90CRI 3000k LED	277V 0-10V/Phase dimming	

ORACLE CEILING MOUNT

FLOURESCENT

EM



2-6143-24-EM

ORACLE CEILING MOUNT

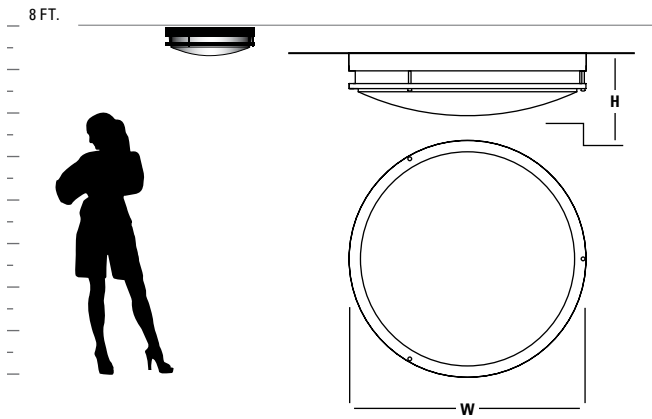

GENERAL SPECIFICATIONS:

- Cold rolled steel housing. • Formed steel trim. • White acrylic diffuser is 1/16" thick. • Unit mounts to 4" octagonal junction box. • Toolless access to lamp. • Approved for wall or ceiling mount applications. • Optional Emergency ballast is Bodine B60 series, up to 450 lumen output in emergency mode. • Visit www.oxygenlighting.com for technical cut sheets. • Oxygen reserves the right to modify designs at any time.

AVAILABLE FINISH



ITEM #	DIFFUSER	FINISH	DIMENSIONS	LAMPING	BALLAST	CERTIFICATION
2-6109-24 small	Matte White Acrylic	24 Satin Nickel	10.5"(w) x 3.5"(h)	1 x 22w T9 circline fluorescent (G10Q)	Electronic, HPF, Instant Start, 120V	ADA c UL US UL damp
2-6110-24 medium	Matte White Acrylic	24 Satin Nickel	17.75"(w) x 4.25"(h)	22w + 32w T9 circline fluorescent (G10Q)	Electronic, HPF, Instant Start, 120V	c UL US UL damp
2-6143-24 large	Matte White Acrylic	24 Satin Nickel	23.75"(W) x 6.25"(h)	32w + 40w T9 circline fluorescent (G10Q)	Electronic, HPF, Instant Start, 120V	c UL US UL damp
2-6143-24-EM large	Matte White Acrylic	24 Satin Nickel	23.75"(W) x 6.25"(h)	32w + 40w T9 circline fluorescent (G10Q)	Electronic, HPF, Instant Start, 120V	EM UL US UL damp

PEEPERS CEILING MOUNT

ADA

LED



3-600-24

PEEPERS CEILING MOUNT



3-600-40



3-600-22

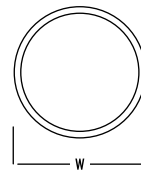
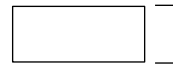
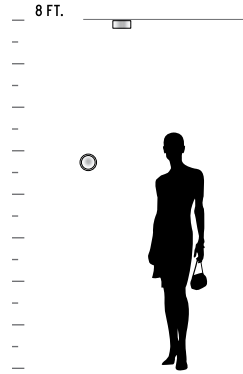

GENERAL SPECIFICATIONS:

- Cold rolled steel housing. • White acrylic diffuser is 1/16" thick.
- Unit mounts to 4" octagonal or 2"x3" junction box. • Unit requires 2.5" deep junction box. • Driver mounts inside junction box. • Approved for ceiling and wall mounted applications. • Total luminaire power 10.2w.
- Visit www.oxygenlighting.com for technical cut sheets. • Oxygen reserves the right to modify designs at any time.

AVAILABLE FINISHES



22 Oiled Bronze



24 Satin Nickel



40 Aged Brass

ITEM #	DIFFUSER	FINISH	DIMENSIONS	LAMPING	DRIVER	CERTIFICATION
3-600-XX	Matte White Acrylic	22 Oiled Bronze 24 Satin Nickel 40 Aged Brass	4.75"(w) x 2"(h)	1 x 8.2w, 90CRI 3000k LED	120V 0-10V/Phase dimming	
37-600-XX	Matte White Acrylic	22 Oiled Bronze 24 Satin Nickel 40 Aged Brass	4.75"(w) x 2"(h)	1 x 8.2w, 90CRI 3000k LED	277V 0-10V/Phase dimming	

2700k, 3500k, 4000k color temperatures also available. Contact Oxygen for ordering information.

PEEPERS CEILING MOUNT

ADA LED EM



32-601-40

PEEPERS CEILING MOUNT

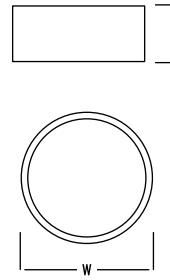
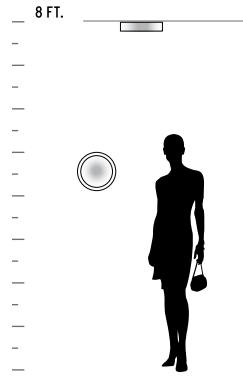

GENERAL SPECIFICATIONS:

- Cold rolled steel housing. • White acrylic diffuser is 1/16" thick.
- Unit mounts to 4" octagonal or 2"x3" junction box. • Unit requires 2.5" deep junction box. • Driver mounts inside junction box. • Approved for ceiling and wall mounted applications. • Total luminaire power 21.2w.
- Visit www.oxygenlighting.com for technical cut sheets. • Oxygen reserves the right to modify designs at any time.

EMERGENCY BATTERY BACKUP MODELS (EM)

- ETL required 90 minute emergency battery run time • 32 hour recharge time.

AVAILABLE FINISHES



ITEM #	DIFFUSER	FINISH	DIMENSIONS	LAMPING	DRIVER	CERTIFICATION
32-601-XX	Matte White Acrylic	20 Polished Nickel 24 Satin Nickel 40 Aged Brass	10.25"(w) x 2.5"(h)	1 x 18w, 90CRI 3000k LED	120/277V 0-10V dimming	
32-601-XX-EM	Matte White Acrylic	20 Polished Nickel 24 Satin Nickel 40 Aged Brass	10.25"(w) x 2.5"(h)	1 x 18w, 90CRI 3000k LED	120/277V 0-10V dimming	

2700k, 3500k, 4000k color temperatures also available for non EM LED models. Contact Oxygen for ordering information.

PILAR CEILING MOUNT

LED



3-309-115

PILAR CEILING MOUNT



3-308-120



37-309-224

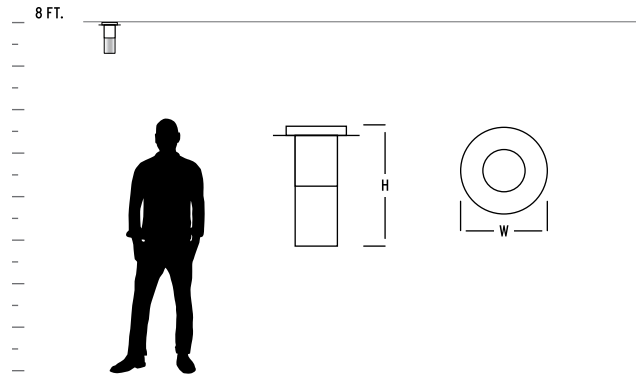

GENERAL SPECIFICATIONS:

- Cold rolled steel housing. • White acrylic diffuser is 1/16" thick.
- Glass difusser is 1/8" thick matte opal • Diffuser screws onto housing with integral threaded fitting. • Model 3-308-XXX/37-308-XXX has 2.75" dia diffuser • Model 3-309-XXX/37-309-XXX has 3.5" dia diffuser • Unit mounts to 4" octagonal or 2"x3" junction box. • Driver mounts inside junction box. • Unit requires 2.5" deep junction box. • Approved for ceiling and wall mounted applications. • Total luminaire power 6.7w. • Visit www.oxygenlighting.com for technical cut sheets. • Oxygen reserves the right to modify designs at any time.

AVAILABLE FINISHES



15 Black

20 Polished Nickel

24 Satin Nickel

ITEM #	DIFFUSER	FINISH	DIMENSIONS	LAMPING	DRIVER	CERTIFICATION
3-308-XXX	1 Matte Opal Glass 2 Matte White Acrylic	15 Black 20 Oiled Bronze 24 Satin Nickel	5.875"(w) x 9"(h)	1 x 5.1w, 90CRI 3000k LED	120V 0-10V/Phase dimming	
37-308-XXX	1 Matte Opal Glass 2 Matte White Acrylic	15 Black 20 Oiled Bronze 24 Satin Nickel	5.875"(w) x 9"(h)	1 x 5.1w, 90CRI 3000k LED	227V 0-10V/Phase dimming	
3-309-XXX	1 Matte Opal Glass 2 Matte White Acrylic	15 Black 20 Oiled Bronze 24 Satin Nickel	5.875"(w) x 10.75"(h)	1 x 5.1w, 90CRI 3000k LED	120V 0-10V/Phase dimming	
37-309-XXX	1 Matte Opal Glass 2 Matte White Acrylic	15 Black 20 Oiled Bronze 24 Satin Nickel	5.875"(w) x 10.75"(h)	1 x 5.1w, 90CRI 3000k LED	227V 0-10V/Phase dimming	

2700k, 3500k, 4000k color temperatures also available. Contact Oxygen for ordering information.

PYXIS CEILING MOUNT

ADA

LED



3-610-24

PYXIS CEILING MOUNT

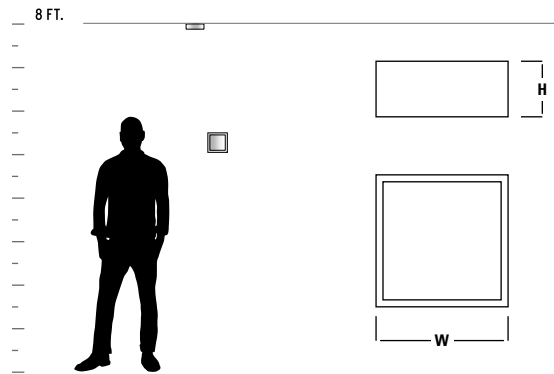







GENERAL SPECIFICATIONS:

- Cold rolled steel housing. • White acrylic diffuser is 1/16" thick.
- Unit mounts to 4" octagonal or 2"x3" junction box. • Driver mounts inside junction box. • Unit requires 2.5" deep junction box. • Approved for ceiling and wall mounted applications. • Total luminaire power 10.3w.
- Visit www.oxygenlighting.com for technical cut sheets. • Oxygen reserves the right to modify designs at any time.

AVAILABLE FINISHES



ITEM #	DIFFUSER	FINISH	DIMENSIONS	LAMPING	DRIVER	CERTIFICATION
3-610-XX	Matte White Acrylic	22 Oiled Bronze 24 Satin Nickel 40 Aged Brass	4.75"(w) x 2"(h)	1 x 8.2w, 90CRI 3000k LED	120V 0-10V/Phase dimming.	  
37-610-XX	Matte White Acrylic	22 Oiled Bronze 24 Satin Nickel 40 Aged Brass	4.75"(w) x 2"(h)	1 x 8.2w, 90CRI 3000k LED	277V 0-10V/Phase dimming.	  

2700k, 3500k, 4000k color temperatures also available. Contact Oxygen for ordering information.

PYXIS CEILING MOUNT

ADA

LED



32-612-40

PYXIS CEILING MOUNT

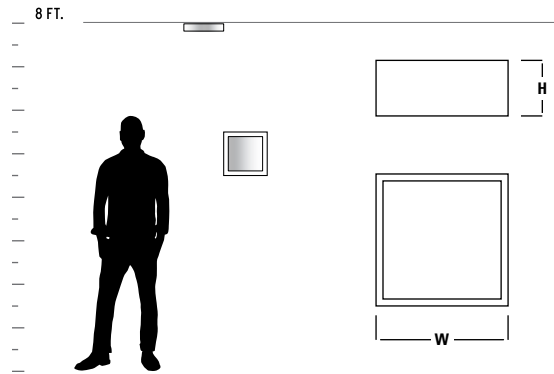



GENERAL SPECIFICATIONS:

- Cold rolled steel housing.
- White acrylic diffuser is 1/16" thick.
- Unit mounts to 4" octagonal or 2"x3" junction box.
- Driver mounts inside junction box.
- Unit requires 2.5" deep junction box.
- Approved for ceiling and wall mounted applications.
- Total luminaire power 26.1w.
- Visit www.oxygenlighting.com for technical cut sheets.
- Oxygen reserves the right to modify designs at any time.

AVAILABLE FINISHES



ITEM #	DIFFUSER	FINISH	DIMENSIONS	LAMPING	DRIVER	CERTIFICATION
32-612-XX	Matte White Acrylic	20 Polished Nickel 24 Satin Nickel 40 Aged Brass	10.25"(w) x 3.25"(h)	1 x 22.2w, 90CRI 3000k LED	120/277V 0-10V dimming	  

2700k, 3500k, 4000k color temperatures also available. Contact Oxygen for ordering information.

RHYTHM CEILING MOUNT

ADA

LED

FLOURESCENT



3-648-6 and 37-649-6

RHYTHM CEILING MOUNT

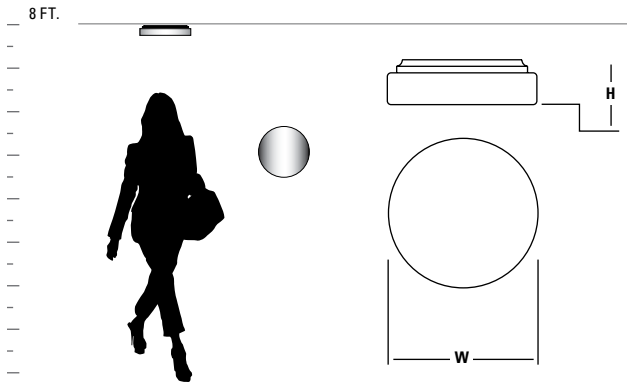

GENERAL SPECIFICATIONS:

- Cold rolled steel housing.
- White acrylic diffuser is 1/16" thick.
- Unit mounts to 4" octagonal junction box.
- Toolless access to lamp for fluorescent models.
- Approved for wall or ceiling mount applications.
- Total luminaire power 10.3w for 3-648-6/37-648-6 and 25.8w for 3-649-6/37-649-6.
- Visit www.oxygenlighting.com for technical cut sheets.
- Oxygen reserves the right to modify designs at any time.



AVAILABLE FINISH



ITEM #	DIFFUSER	FINISH	DIMENSIONS	LAMPING	BALLAST	DRIVER	CERTIFICATION
2-6138-6 small	Matte White Acrylic	6 White	10"(w) x 3"(h)	1 x 22w T9 circline fluorescent (G10Q)	Electronic HPF, instant start, 120V	--	ADA COMPLIANT, cUL US damp
2-6139-6 large	Matte White Acrylic	6 White	14"(w) x 2.75"(h)	22w + 32w T9 circline fluorescent (G10Q)	Electronic HPF, instant start, 120V	--	ADA COMPLIANT, cUL US damp
3-648-6 small	Matte White Acrylic	6 White	10"(w) x 3"(h)	1 x 8.2w, 90CRI 3000k LED	--	120V 0-10V/Phase dimming	ADA COMPLIANT, cETL us damp
37-648-6 small	Matte White Acrylic	6 White	10"(w) x 3"(h)	1 x 8.2w, 90CRI 3000k LED	--	277V 0-10V/Phase dimming	ADA COMPLIANT, cETL us damp
3-649-6 large	Matte White Acrylic	6 White	14"(w) x 2.75"(h)	2 x 10.1w, 90CRI 3000k LED	--	120V 0-10V/Phase dimming	ADA COMPLIANT, cETL us damp
37-649-6 large	Matte White Acrylic	6 White	14"(w) x 2.75"(h)	2 x 10.1w, 90CRI 3000k LED	--	277V 0-10V/Phase dimming	ADA COMPLIANT, cETL us damp

2700k, 3500k, 4000k color temperatures also available for LED models. Contact Oxygen for ordering information.





pendants

COMET PENDANT

LED



3-650-1314

COMET PENDANT



3-650-14



3-650-2018



Multi-pendant canopy options. See page 276-277.

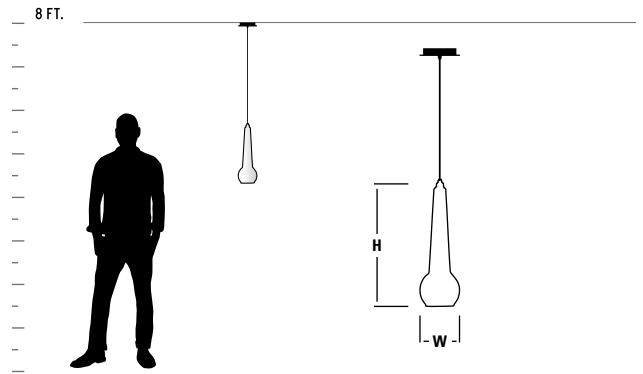

GENERAL SPECIFICATIONS:

- Cold rolled steel canopy.
- Blown glass is 1/16" thick.
- *Height measured not including adjustable cord or ceiling canopy.
- Fixture supplied with 10' cord.
- Unit mounts to 4" octagonal junction box.
- Optional multi-pendant canopies available for 3, 5, and 7 lights.
- Total luminaire power 6.6w.
- Visit www.oxygenlighting.com for technical cut sheets.
- Oxygen reserves the right to modify designs at any time.













AVAILABLE FINISHES



14 Polished Chrome



18 Gunmetal

ITEM #	DIFFUSER	FINISH	DIMENSIONS	LAMPING	DRIVER	CERTIFICATION
3-650-14	Clear Glass	14 Polished Chrome	5.25"(w) x 17.25"(h)*	1 x 5.1w, 90CRI 3000k LED	120V 0-10V/Phase dimming	 
37-650-14	Clear Glass	14 Polished Chrome	5.25"(w) x 17.25"(h)*	1 x 5.1w, 90CRI 3000k LED	277V 0-10V/Phase dimming	 
3-650-1314	13 Smoked Ombre Glass	14 Polished Chrome	5.25"(w) x 17.25"(h)*	1 x 5.1w, 90CRI 3000k LED	120V 0-10V/Phase dimming	 
37-650-1314	13 Smoked Ombre Glass	14 Polished Chrome	5.25"(w) x 17.25"(h)*	1 x 5.1w, 90CRI 3000k LED	277V 0-10V/Phase dimming	 
3-650-2018	20 Coffee Ombre Glass	18 Gunmetal	5.25"(w) x 17.25"(h)*	1 x 5.1w, 90CRI 3000k LED	120V 0-10V/Phase dimming	 
37-650-2018	20 Coffee Ombre Glass	18 Gunmetal	5.25"(w) x 17.25"(h)*	1 x 5.1w, 90CRI 3000k LED	277V 0-10V/Phase dimming	 

2700k, 3500k, 4000k color temperatures also available. Contact Oxygen for ordering information.

CORNET PENDANT

LED



3-651-1314

3-651-2018

CORNET PENDANT



3-651-14



Multi-pendant canopy options. See page 276-277.

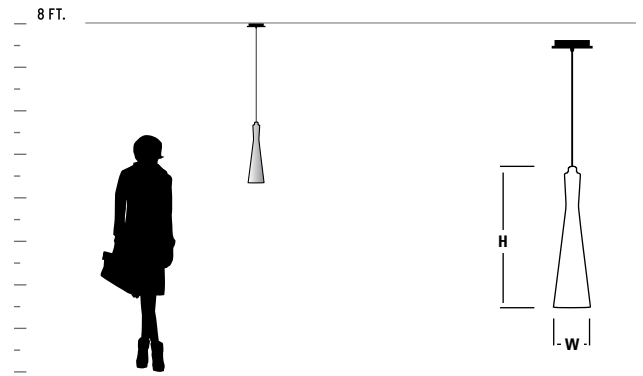

GENERAL SPECIFICATIONS:

- Cold rolled steel canopy.
- Blown glass is 1/16" thick.
- *Height measured not including adjustable cord or ceiling canopy.
- Fixture supplied with 10' cord.
- Unit mounts to 4" octagonal junction box.
- Optional multi-pendant canopies available for 3, 5, and 7 lights.
- Total luminaire power 6.6w.
- Visit www.oxygenlighting.com for technical cut sheets.
- Oxygen reserves the right to modify designs at any time.

AVAILABLE FINISHES



14 Polished Chrome



18 Gunmetal

ITEM #	DIFFUSER	FINISH	DIMENSIONS	LAMPING	DRIVER	CERTIFICATION
3-651-14	Clear Glass	14 Polished Chrome	4.25"(w) x 17.25"(h)*	1 x 5.1w, 90CRI 3000k LED	120V 0-10V/Phase dimming	
37-651-14	Clear Glass	14 Polished Chrome	4.25"(w) x 17.25"(h)*	1 x 5.1w, 90CRI 3000k LED	277V 0-10V/Phase dimming	
3-651-1314	13 Smoked Ombre Glass	14 Polished Chrome	4.25"(w) x 17.25"(h)*	1 x 5.1w, 90CRI 3000k LED	120V 0-10V/Phase dimming	
37-651-1314	13 Smoked Ombre Glass	14 Polished Chrome	4.25"(w) x 17.25"(h)*	1 x 5.1w, 90CRI 3000k LED	277V 0-10V/Phase dimming	
3-651-2018	20 Coffee Ombre Glass	18 Gunmetal	4.25"(w) x 17.25"(h)*	1 x 5.1w, 90CRI 3000k LED	120V 0-10V/Phase dimming	
37-651-2018	20 Coffee Ombre Glass	18 Gunmetal	4.25"(w) x 17.25"(h)*	1 x 5.1w, 90CRI 3000k LED	277V 0-10V/Phase dimming	

2700k, 3500k, 4000k color temperatures also available. Contact Oxygen for ordering information.

DIONE PENDANT

LED



32-660-24

DIONE PENDANT



32-661-24

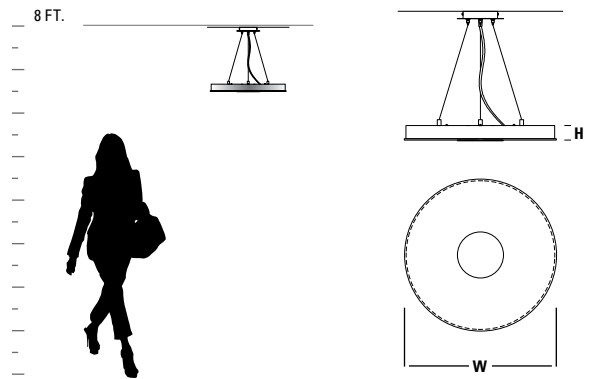

GENERAL SPECIFICATIONS:

- Spun steel housing. • Frost white glass diffuser is 1/8" thick. • Aircraft cable support. • 4' cord/cable provided. • Units mount to 4" octagonal junction box. • Total luminaire power 11.2w for 32-660-24 and 23.5w for 32-661-24. • Visit www.oxygenlighting.com for technical cut sheets.
- Oxygen reserves the right to modify designs at any time.

AVAILABLE FINISH



24 Satin Nickel

ITEM #	DIFFUSER	FINISH	DIMENSIONS	LAMPING	DRIVER	CERTIFICATION
32-660-24 small	Frosted Glass	24 Satin Nickel	15"(w) x 2.25"(h)	1 x 9.9w, 90CRI 3000k LED	120/277V 0-10V dimming	
32-661-24 large	Frosted Glass	24 Satin Nickel	21"(w) x 2.25"(h)	1 x 20.7w, 90CRI 3000k LED	120/277V 0-10V dimming	

2700k, 3500k, 4000k color temperatures also available. Contact Oxygen for ordering information.

ECHO PENDANT

LED

ENERGY STAR



3-639-22

ECHO PENDANT

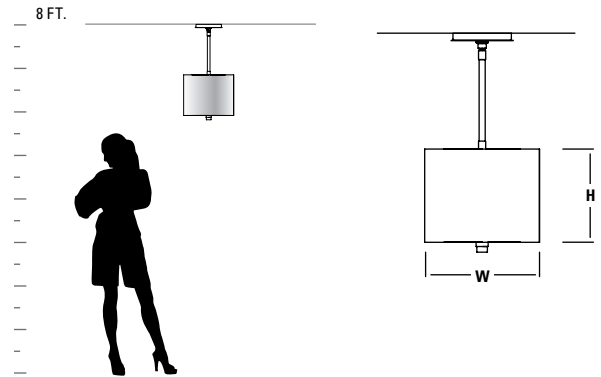

GENERAL SPECIFICATIONS:

- Cold rolled Steel Canopy. • Grass shades are natural bamboo fibers.
- Acrylic diffuser. • Cast steel with acrylic finial. • *Height measured not including stem or ceiling canopy. • Stem is custom cut at oxygen facility to customer's specification (maximum stem length 60"). • Canopy swivel allows for mounting on sloped ceilings – up to 30-degrees. • Unit mounts to 4" octagonal junction box. • Total luminaire power 39w for 3-638-XX/37-638-XX, 38.9w for 3-639-XX/37-639-XX, and 52.6w for 3-640-XX/37-640-XX. • Visit www.oxygenlighting.com for technical cut sheets. • Oxygen reserves the right to modify designs at any time.

AVAILABLE FINISHES



ITEM #	DIFFUSER	FINISH	DIMENSIONS	LAMPING	DRIVER	CERTIFICATION
3-638-XX small	White Grass Shade with Acrylic	22 Oiled Bronze 24 Satin Nickel	18"(w) x 10.625"(h)*	3 x 9w, 90CRI 3000k LED	120V 0-10V/Phase dimming	
37-638-XX small	White Grass Shade with Acrylic	22 Oiled Bronze 24 Satin Nickel	18"(w) x 10.625"(h)*	3 x 9w, 90CRI 3000k LED	277V 0-10V/Phase dimming	
3-639-XX medium	White Grass Shade with Acrylic	22 Oiled Bronze 24 Satin Nickel	24"(w) x 10.625"(h)*	3 x 9w, 90CRI 3000k LED	120V 0-10V/Phase dimming	
37-639-XX medium	White Grass Shade with Acrylic	22 Oiled Bronze 24 Satin Nickel	24"(w) x 10.625"(h)*	3 x 9w, 90CRI 3000k LED	277V 0-10V/Phase dimming	
3-640-XX large	White Grass Shade with Acrylic	22 Oiled Bronze 24 Satin Nickel	30"(w) x 10.625"(h)*	4 x 9w, 90CRI 3000k LED	120V 0-10V/Phase dimming	
37-640-XX large	White Grass Shade with Acrylic	22 Oiled Bronze 24 Satin Nickel	30"(w) x 10.625"(h)*	4 x 9w, 90CRI 3000k LED	277V 0-10V/Phase dimming	

2700k, 3500k, 4000k color temperatures also available. Contact Oxygen for ordering information.

ELEMENTS PENDANT

LED



3-8130-24

ELEMENTS PENDANT

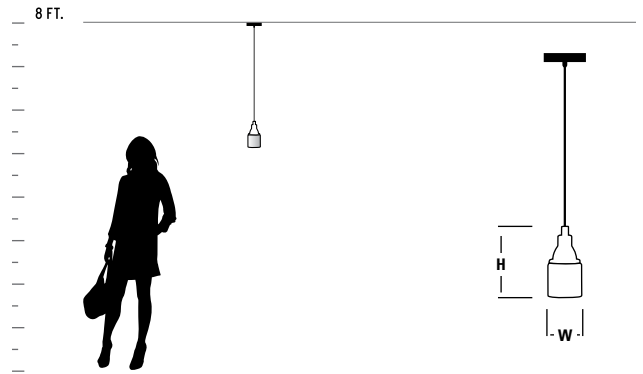

GENERAL SPECIFICATIONS:

- Cold rolled steel housing and canopy. • Diffusers are 1/8" thick matte opal glass. • Diffuser screws onto housing with integral threaded fitting.
- *Height measured not including stem or ceiling canopy. • Stem is custom cut at oxygen facility to customer's specification (maximum stem length 60").
- Unit mounts to 4" octagonal junction box. • Toolless access to lamp. • Visit www.oxygenlighting.com for technical cut sheets.
- Oxygen reserves the right to modify designs at any.

AVAILABLE FINISHES



ITEM #	DIFFUSER	FINISH	DIMENSIONS	LAMPING	CERTIFICATION
3-8110-XX	Matte Opal Glass	14 Polished Chrome 24 Satin Nickel	3.5"(w) x 6.5"(h) *	1 x 7w MAX GU10 120V LED ONLY (lamp not included)	
3-8120-XX	Matte Opal Glass	14 Polished Chrome 24 Satin Nickel	3.5"(w) x 6.5"(h) *	1 x 7w MAX GU10 120V LED ONLY (lamp not included)	
3-8130-XX	Matte Opal Glass	14 Polished Chrome 24 Satin Nickel	4.5"(w) x 6.5"(h) *	1 x 7w MAX GU10 120V LED ONLY (lamp not included)	

GALAXY PENDANT

LED



3-634-1314

3-634-2018

GALAXY PENDANT

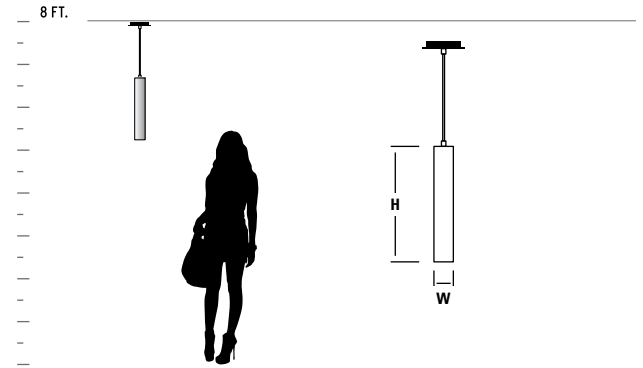

GENERAL SPECIFICATIONS:

- Cold rolled steel canopy. • Blown glass is 1/16" thick. • *Height measured not including adjustable cord or ceiling canopy. • Fixture supplied with 10' cord. • Unit mounts to 4" octagonal junction box.
- Optional multi-pendant canopies available for 3, 5, and 7 lights.
- Total luminaire power 6.6w. • Visit www.oxygenlighting.com for technical cut sheets. • Oxygen reserves the right to modify designs at any time.

AVAILABLE FINISHES



ITEM #	DIFFUSER	FINISH	DIMENSIONS	LAMPING	DRIVER	CERTIFICATION
3-634-14	Clear Glass	14 Polished Chrome	2.75"(w) x 17"(h)	1 x 5.1w, 90CRI 3000k LED	120V 0-10V/Phase dimming	
37-634-14	Clear Glass	14 Polished Chrome	2.75"(w) x 17"(h)	1 x 5.1w, 90CRI 3000k LED	277V 0-10V/Phase dimming	
3-634-1314	13 Smoked Ombre Glass	14 Polished Chrome	2.75"(w) x 17"(h)	1 x 5.1w, 90CRI 3000k LED	120V 0-10V/Phase dimming	
37-634-1314	13 Smoked Ombre Glass	14 Polished Chrome	2.75"(w) x 17"(h)	1 x 5.1w, 90CRI 3000k LED	277V 0-10V/Phase dimming	
3-634-1414	14 Mirrored Glass	14 Polished Chrome	2.75"(w) x 17"(h)	1 x 5.1w, 90CRI 3000k LED	120V 0-10V/Phase dimming	
37-634-1414	14 Mirrored Glass	14 Polished Chrome	2.75"(w) x 17"(h)	1 x 5.1w, 90CRI 3000k LED	277V 0-10V/Phase dimming	
3-634-2018	20 Coffee Ombre Glass	18 Gunmetal	2.75"(w) x 17"(h)	1 x 5.1w, 90CRI 3000k LED	120V 0-10V/Phase dimming	
37-634-2018	20 Coffee Ombre Glass	18 Gunmetal	2.75"(w) x 17"(h)	1 x 5.1w, 90CRI 3000k LED	277V 0-10V/Phase dimming	

2700k, 3500k, 4000k color temperatures also available. Contact Oxygen for ordering information.

GRATIS PENDANT

LED



3-609-1414

GRATIS PENDANT

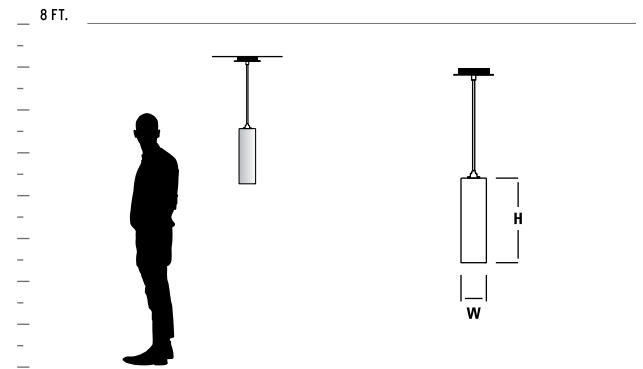

GENERAL SPECIFICATIONS:

- Cold rolled steel canopy. • Blown glass is 1/16" thick. • *Height measured not including adjustable cord or ceiling canopy. • Fixture supplied with 10' cord. • Unit mounts to 4" octagonal junction box. • Optional multi-pendant canopies available for 3, 5, and 7 lights. • Total luminaire power 6.5w. • Visit www.oxygenlighting.com for technical cut sheets. • Oxygen reserves the right to modify designs at any time.

AVAILABLE FINISHES



ITEM #	DIFFUSER	FINISH	DIMENSIONS	LAMPING	DRIVER	CERTIFICATION
3-609-14	Clear Glass	14 Polished Chrome	3.75"(w) x 15.5"(h)	1 x 5.1w, 90CRI 3000k LED	120V 0-10V/Phase dimming	
37-609-14	Clear Glass	14 Polished Chrome	3.75"(w) x 15.5"(h)	1 x 5.1w, 90CRI 3000k LED	277V 0-10V/Phase dimming	
3-609-124	Satin Opal Glass	24 Satin Nickel	3.75"(w) x 15.5"(h)	1 x 5.1w, 90CRI 3000k LED	120V 0-10V/Phase dimming	
37-609-124	Satin Opal Glass	24 Satin Nickel	3.75"(w) x 15.5"(h)	1 x 5.1w, 90CRI 3000k LED	277V 0-10V/Phase dimming	
3-609-1314	13 Smoked Ombre Glass	14 Polished Chrome	3.75"(w) x 15.5"(h)	1 x 5.1w, 90CRI 3000k LED	120V 0-10V/Phase dimming	
37-609-1314	13 Smoked Ombre Glass	14 Polished Chrome	3.75"(w) x 15.5"(h)	1 x 5.1w, 90CRI 3000k LED	277V 0-10V/Phase dimming	
3-609-1414	14 Mirrored Glass	14 Polished Chrome	3.75"(w) x 15.5"(h)	1 x 5.1w, 90CRI 3000k LED	120V 0-10V/Phase dimming	
37-609-1414	14 Mirrored Glass	14 Polished Chrome	3.75"(w) x 15.5"(h)	1 x 5.1w, 90CRI 3000k LED	277V 0-10V/Phase dimming	
3-609-2018	20 Coffee Ombre Glass	18 Gunmetal	3.75"(w) x 15.5"(h)	1 x 5.1w, 90CRI 3000k LED	120V 0-10V/Phase dimming	
37-609-2018	20 Coffee Ombre Glass	18 Gunmetal	3.75"(w) x 15.5"(h)	1 x 5.1w, 90CRI 3000k LED	277V 0-10V/Phase dimming	

2700k, 3500k, 4000k color temperatures also available. Contact Oxygen for ordering information.

IDOL PENDANT

LED



IDOL PENDANT

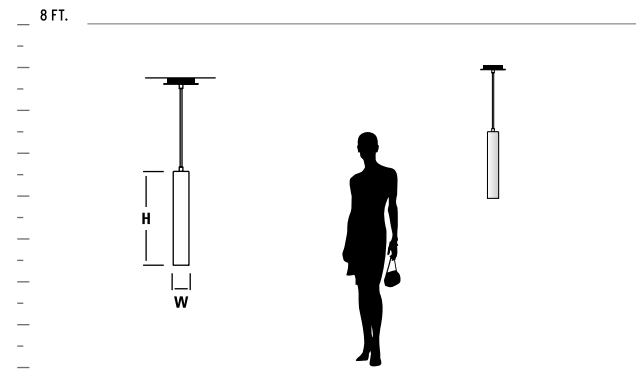
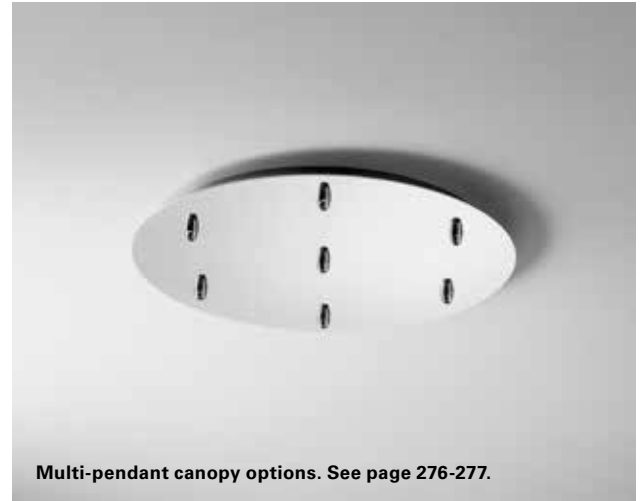

GENERAL SPECIFICATIONS:

- Cold rolled steel canopy. • *Height measured not including adjustable cord or ceiling canopy. • Fixture supplied with 10' cord. • Unit mounts to 4" octagonal junction box. • Optional multi-pendant canopies available for 3, 5, and 7 lights. • Total luminaire power 6.6w. • Visit www.oxygenlighting.com for technical cut sheets. • Oxygen reserves the right to modify designs at any time.

AVAILABLE FINISHES



ITEM #	FINISH/DIFFUSER	DIMENSIONS	LAMPING	DRIVER	CERTIFICATION
3-635-XX	14 Polished Chrome 18 Gunmetal 24 Satin Nickel	2.75"(w) x 18.5"(h)*	1 x 5.1w, 90CRI 3000k LED	120V 0-10V/Phase dimming	
37-635-XX	14 Polished Chrome 18 Gunmetal 24 Satin Nickel	2.75"(w) x 18.5"(h)*	1 x 5.1w, 90CRI 3000k LED	277V 0-10V/Phase dimming	

2700k, 3500k, 4000k color temperatures also available. Contact Oxygen for ordering information.

INA PENDANT

FLOURESCENT



2-6209-24

INA PENDANT



2-6209-24

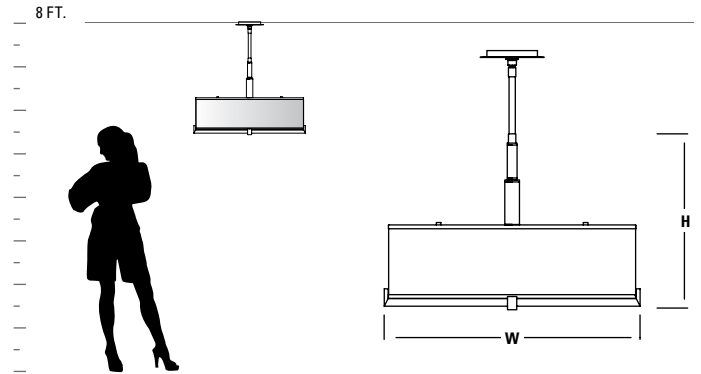

GENERAL SPECIFICATIONS:

- Cold rolled Steel Canopy. • Formed steel trim/frame. • Grass shades are natural bamboo fibers. • Acrylic diffuser. • *Height measured not including stem or ceiling canopy. • Stem is custom cut at oxygen facility to customer's specification (maximum stem length 60"). • Toolless lamp access. • Canopy swivel allows for mounting on sloped ceilings – up to 30-degrees. • Unit mounts to 4" octagonal junction box. • Visit www.oxygenlighting.com for technical cut sheets. • Oxygen reserves the right to modify designs at any time.

AVAILABLE FINISH



24 Satin Nickel

ITEM #	DIFFUSER	FINISH	DIMENSIONS	LAMPING	CERTIFICATION
2-6209-24	White Grass Shade with Acrylic	24 Satin Nickel	26.25"(w) x 17.25"(h)*	4 x 23w GU24 120V (self-ballasted lamp included)	c US

KLONE PENDANT

LED



32-642-15

KLONE PENDANT

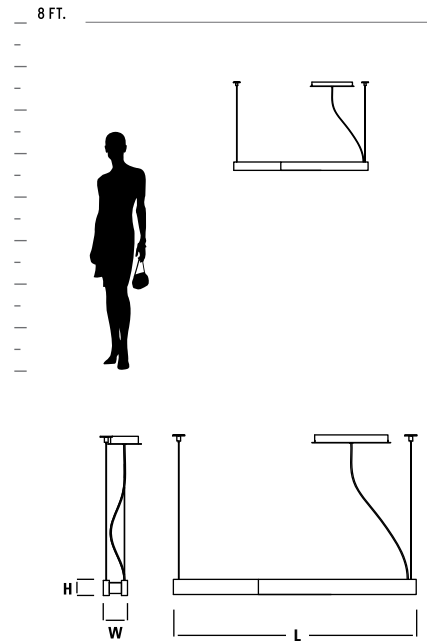

GENERAL SPECIFICATIONS:

- Cold rolled steel canopy. • Unit mounts to 4" octagonal junction box.
- Fixture supplied with 10' cord and 12.5' aircraft cable. • Total luminaire power 56.7w. • Visit www.oxygenlighting.com for technical cut sheets.
- Oxygen reserves the right to modify designs at any time.

AVAILABLE FINISHES



ITEM #	DIFFUSER	FINISH	DIMENSIONS	LAMPING	DRIVER	CERTIFICATION
32-642-XX	Matte White Acrylic	15 Black 20 Polished Nickel 24 Satin Nickel	38"(l) x 4"x(w) 2.5"(h)*	2 x 25w, 90CRI 3000k LED	120/277V 0-10V dimming	

2700k, 3500k, 4000k color temperatures also available. Contact Oxygen for ordering information.

LIBERTY PENDANT

LED



3-652-14



3-652-2018

LIBERTY PENDANT

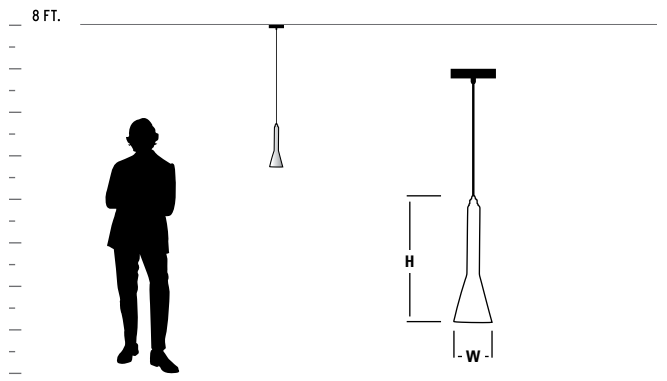
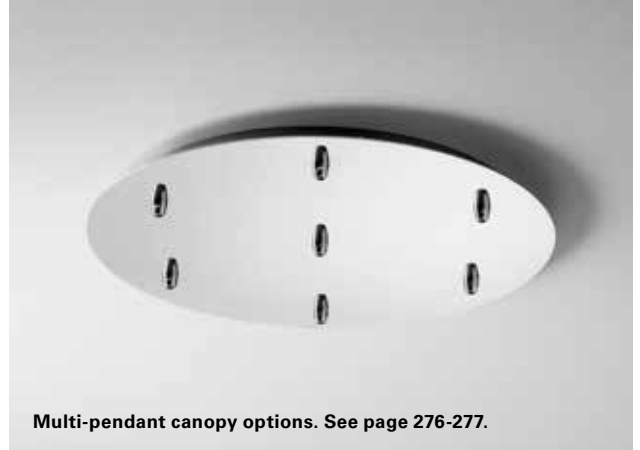

GENERAL SPECIFICATIONS:

- Cold rolled steel canopy.
- Blown glass is 1/16" thick.
- *Height measured not including adjustable cord or ceiling canopy.
- Fixture supplied with 10' cord.
- Unit mounts to 4" octagonal junction box.
- Optional multi-pendant canopies available for 3, 5, and 7 lights.
- Total luminaire power 6.6w.
- Visit www.oxygenlighting.com for technical cut sheets.
- Oxygen reserves the right to modify designs at any time.

AVAILABLE FINISHES

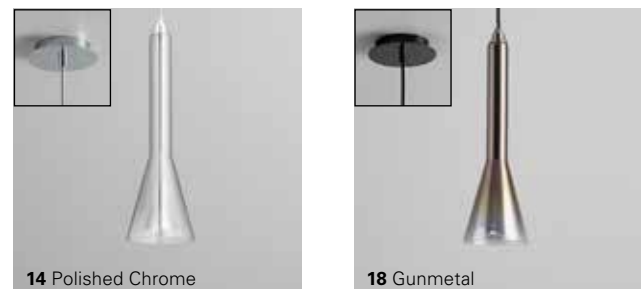

ITEM #	DIFFUSER	FINISH	DIMENSIONS	LAMPING	DRIVER	CERTIFICATION
3-652-14	Clear Glass	14 Polished Chrome	5"(w) x 16.25"(h)*	1 x 5.1w, 90CRI 3000k LED	120V 0-10V/Phase dimming	
37-652-14	Clear Glass	14 Polished Chrome	5"(w) x 16.25"(h)*	1 x 5.1w, 90CRI 3000k LED	277V 0-10V/Phase dimming	
3-652-1314	13 Smoked Ombre Glass	14 Polished Chrome	5"(w) x 16.25"(h)*	1 x 5.1w, 90CRI 3000k LED	120V 0-10V/Phase dimming	
37-652-1314	13 Smoked Ombre Glass	14 Polished Chrome	5"(w) x 16.25"(h)*	1 x 5.1w, 90CRI 3000k LED	277V 0-10V/Phase dimming	
3-652-2018	20 Coffee Ombre Glass	18 Gunmetal	5"(w) x 16.25"(h)*	1 x 5.1w, 90CRI 3000k LED	120V 0-10V/Phase dimming	
37-652-2018	20 Coffee Ombre Glass	18 Gunmetal	5"(w) x 16.25"(h)*	1 x 5.1w, 90CRI 3000k LED	277V 0-10V/Phase dimming	

2700k, 3500k, 4000k color temperatures also available. Contact Oxygen for ordering information.

LOTUS PENDANT

FLOURESCENT



2-6107-24

LOTUS PENDANT

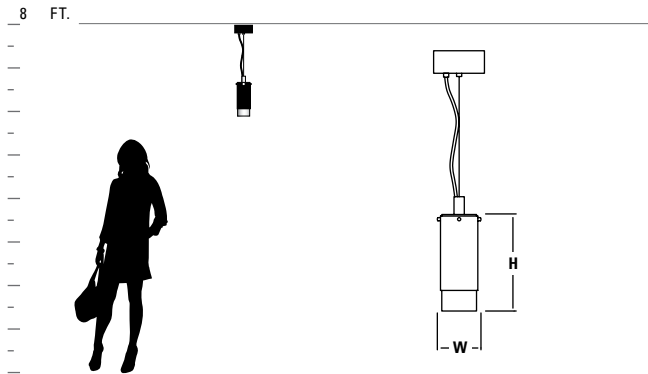

GENERAL SPECIFICATIONS:

- Formed steel canopy. • Cold rolled steel housing. • White Opal glass diffuser is 3/16" thick.
- *Height measured not including adjustable cord or ceiling canopy. • Optional perforated sleeve included. • Perforated metal overlay in natural steel finish. • Unit mount to standard 4" octagonal junction box. • To avoid possible abnormal end of life, use lamps with integral End of Life protection.
- 10' cord provided. • Visit www.oxygenlighting.com for technical cut sheets. • Oxygen reserves the right to modify designs at any time.

AVAILABLE FINISH



ITEM #	DIFFUSER	FINISH	DIMENSIONS	LAMPING	BALLAST	CERTIFICATION
2-6107-24	White Opal Glass	24 Satin Nickel	3.25"(w) x 9.5"(h)*	1 x 13w quad 4-pin fluorescent (G24q-1)	Electronic, HPF, instant start, 120V	

LUNA PENDANT

LED



3-670-40

LUNA PENDANT

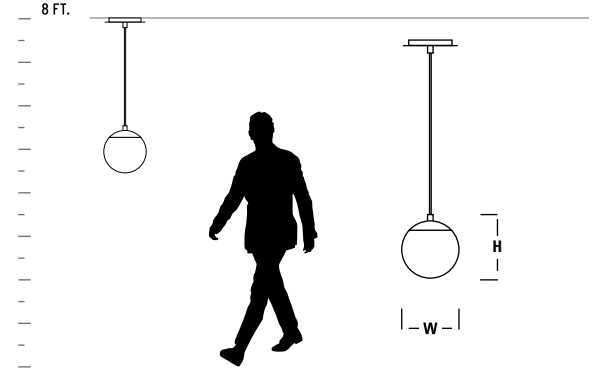

GENERAL SPECIFICATIONS:

• Cold rolled steel housing and canopy. • Matte opal glass is 1/8" thick. • *Height measured not including adjustable cord or ceiling canopy. • Fixture supplied with 10' cord. • Unit mounts to 4" octagonal junction box. • Optional multi-pendant canopies available for 3, 5, and 7 lights. • Total luminaire power 6.7w for 3-670-XX/37-670-XX and 3-671-XX/3-671-XX, 10.5w for 3-673-XX/37-673-XX and 3-674-XX/37-674. • Visit www.oxygenlighting.com for technical cut sheets. • Oxygen reserves the right to modify designs at any time.

AVAILABLE FINISHES



ITEM #	DIFFUSER	FINISH	DIMENSIONS	LAMPING	DRIVER	CERTIFICATION
3-670-XX	Matte Opal Glass	20 Polished Nickel 22 Oiled Bronze 24 Satin Nickel 40 Aged Brass	6"(w) x 8.25"(h)*	1 x 5.1w, 90CRI 3000k LED	120V 0-10V/Phase dimming	
37-670-XX	Matte Opal Glass	20 Polished Nickel 22 Oiled Bronze 24 Satin Nickel 40 Aged Brass	6"(w) x 8.25"(h)*	1 x 5.1w, 90CRI 3000k LED	277V 0-10V/Phase dimming	
3-671-XX	Matte Opal Glass	20 Polished Nickel 22 Oiled Bronze 24 Satin Nickel 40 Aged Brass	8"(w) x 9.5"(h)*	1 x 5.1w, 90CRI 3000k LED	120V 0-10V/Phase dimming	
37-671-XX	Matte Opal Glass	20 Polished Nickel 22 Oiled Bronze 24 Satin Nickel 40 Aged Brass	8"(w) x 9.5"(h)*	1 x 5.1w, 90CRI 3000k LED	277V 0-10V/Phase dimming	
3-672-XX	Matte Opal Glass	20 Polished Nickel 22 Oiled Bronze 24 Satin Nickel 40 Aged Brass	10"(w) x 13"(h)*	1 x 8.2w, 90CRI 3000k LED	120V 0-10V/Phase dimming	
37-672-XX	Matte Opal Glass	20 Polished Nickel 22 Oiled Bronze 24 Satin Nickel 40 Aged Brass	10"(w) x 13"(h)*	1 x 8.2w, 90CRI 3000k LED	277V 0-10V/Phase dimming	
3-673-XX	Matte Opal Glass	20 Polished Nickel 22 Oiled Bronze 24 Satin Nickel 40 Aged Brass	12"(w) x 13.75"(h)*	1 x 8.2w, 90CRI 3000k LED	120V 0-10V/Phase dimming	
37-673-XX	Matte Opal Glass	20 Polished Nickel 22 Oiled Bronze 24 Satin Nickel 40 Aged Brass	12"(w) x 13.75"(h)*	1 x 8.2w, 90CRI 3000k LED	277V 0-10V/Phase dimming	

2700k, 3500k, 4000k color temperatures also available. Contact Oxygen for ordering information.

MAGNETA PENDANT

LED



MAGNETA PENDANT

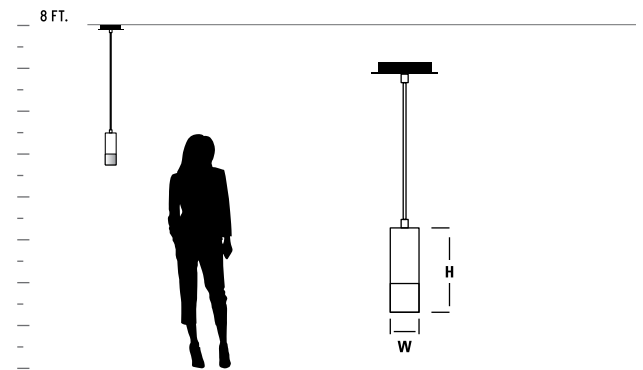

GENERAL SPECIFICATIONS:

- Cold rolled steel canopy. • Matte white acrylic is 1/16" thick. • Blown glass is 1/8" thick. • *Height measured not including adjustable cord or ceiling canopy.
- Fixture supplied with 10' cord. • Unit mounts to 4" octagonal junction box.
- Optional multi-pendant canopies available for 3, 5, and 7 lights. • Total luminaire power 6.6w. • Visit www.oxygenlighting.com for technical cut sheets. • Oxygen reserves the right to modify designs at any time.

AVAILABLE FINISHES



ITEM #	DIFFUSER	FINISH	DIMENSIONS	LAMPING	DRIVER	CERTIFICATION
3-607-XX	Matte White Acrylic	14 Polished Chrome 24 Satin Nickel 40 Aged Brass	2.75"(w) x 9.75"(h)	1 x 5.1w, 90CRI 3000k LED	120V 0-10V/Phase dimming	
37-607-XX	Matte White Acrylic	14 Polished Chrome 24 Satin Nickel 40 Aged Brass	2.75"(w) x 9.75"(h)	1 x 5.1w, 90CRI 3000k LED	277V 0-10V/Phase dimming	
3-607-1XX	1 Matte Opal Glass	14 Polished Chrome 24 Satin Nickel 40 Aged Brass	2.75"(w) x 9.75"(h)	1 x 5.1w, 90CRI 3000k LED	120V 0-10V/Phase dimming	
37-607-1XX	1 Matte Opal Glass	14 Polished Chrome 24 Satin Nickel 40 Aged Brass	2.75"(w) x 9.75"(h)	1 x 5.1w, 90CRI 3000k LED	277V 0-10V/Phase dimming	

2700k, 3500k, 4000k color temperatures also available. Contact Oxygen for ordering information.

MAGNETA PENDANT

LED



MAGNETA PENDANT

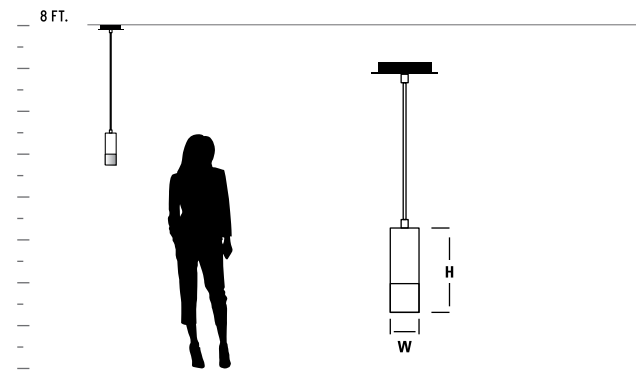

GENERAL SPECIFICATIONS:

- Cold rolled steel canopy.
- Matte white acrylic is 1/16" thick.
- Blown glass is 1/8" thick.
- *Height measured not including adjustable cord or ceiling canopy.
- Fixture supplied with 10' cord.
- Unit mounts to 4" octagonal junction box.
- Optional multi-pendant canopies available for 3, 5, and 7 lights.
- Total luminaire power 6.7w.
- Visit www.oxygenlighting.com for technical cut sheets.
- Oxygen reserves the right to modify designs at any time.

AVAILABLE FINISHES



ITEM #	DIFFUSER	FINISH	DIMENSIONS	LAMPING	DRIVER	CERTIFICATION
3-608-XX	Matte White Acrylic	14 Polished Chrome 24 Satin Nickel 40 Aged Brass	2.75"(w) x 16"(h)	1 x 5.1w, 90CRI 3000k LED	120V 0-10V/Phase dimming	
37-608-XX	Matte White Acrylic	14 Polished Chrome 24 Satin Nickel 40 Aged Brass	2.75"(w) x 16"(h)	1 x 5.1w, 90CRI 3000k LED	277V 0-10V/Phase dimming	
3-608-1XX	1 Matte Opal Glass	14 Polished Chrome 24 Satin Nickel 40 Aged Brass	2.75"(w) x 16"(h)	1 x 5.1w, 90CRI 3000k LED	120V 0-10V/Phase dimming	
37-608-1XX	1 Matte Opal Glass	14 Polished Chrome 24 Satin Nickel 40 Aged Brass	2.75"(w) x 16"(h)	1 x 5.1w, 90CRI 3000k LED	277V 0-10V/Phase dimming	

2700k, 3500k, 4000k color temperatures also available. Contact Oxygen for ordering information.

MAGNUM PENDANT

LED



3-653-40

MAGNUM PENDANT

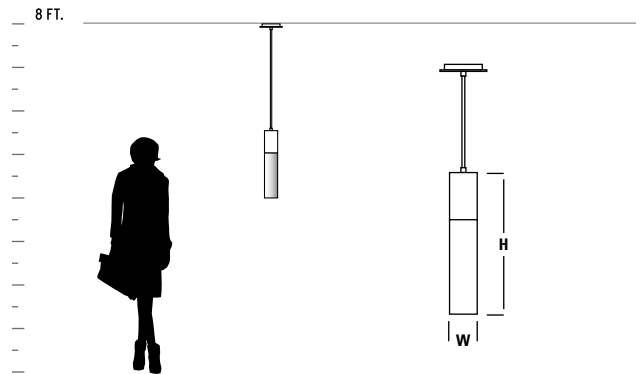

GENERAL SPECIFICATIONS:

- Aluminum housing. • Cold rolled steel canopy. • Matte white acrylic is 1/16" thick. • Blown glass is 1/8" thick. • *Height measured not including adjustable cord or ceiling canopy. • Fixture supplied with 10' cord. • Unit mounts to 4" octagonal junction box. • Optional multi-pendant canopies available for 3, 5, and 7 lights. • Total luminaire power 6.6w. • Visit www.oxygenlighting.com for technical cut sheets. • Oxygen reserves the right to modify designs at any time.

AVAILABLE FINISHES



ITEM #	DIFFUSER	FINISH	DIMENSIONS	LAMPING	DRIVER	CERTIFICATION
3-653-XX	Matte White Acrylic	14 Polished Chrome 24 Satin Nickel 25 Satin Copper 40 Aged Brass	3.5"(w) x 18"(h)*	1 x 5.1w, 90CRI 3000k LED	120V 0-10V/Phase dimming	
37-653-XX	Matte White Acrylic	14 Polished Chrome 24 Satin Nickel 25 Satin Copper 40 Aged Brass	3.5"(w) x 18"(h)*	1 x 5.1w, 90CRI 3000k LED	277V 0-10V/Phase dimming	
3-653-1XX	1 Matte Opal Glass	14 Polished Chrome 24 Satin Nickel 25 Satin Copper 40 Aged Brass	3.5"(w) x 18"(h)*	1 x 5.1w, 90CRI 3000k LED	120V 0-10V/Phase dimming	
37-653-1XX	1 Matte Opal Glass	14 Polished Chrome 24 Satin Nickel 25 Satin Copper 40 Aged Brass	3.5"(w) x 18"(h)*	1 x 5.1w, 90CRI 3000k LED	277V 0-10V/Phase dimming	

2700k, 3500k, 4000k color temperatures also available. Contact Oxygen for ordering information.

OPUS PENDANT

LED



3-654-24

OPUS PENDANT

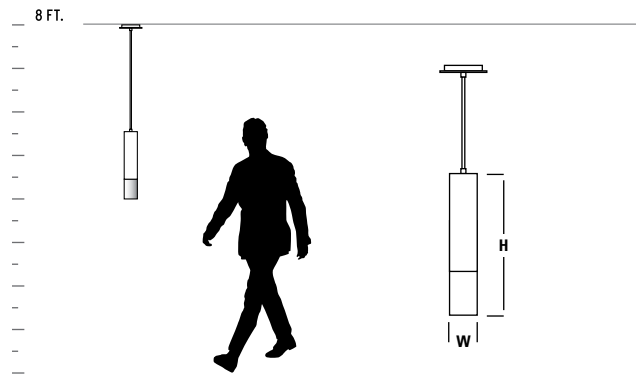

GENERAL SPECIFICATIONS:

- Aluminum housing. • Cold rolled steel canopy. • Matte white acrylic is 1/16" thick. • Blown glass is 1/8" thick. • *Height measured not including adjustable cord or ceiling canopy. • Fixture supplied with 10' cord. • Unit mounts to 4" octagonal junction box. • Optional multi-pendant canopies available for 3, 5, and 7 lights. • Total luminaire power 6.6w. • Visit www.oxygenlighting.com for technical cut sheets. • Oxygen reserves the right to modify designs at any time.

AVAILABLE FINISHES

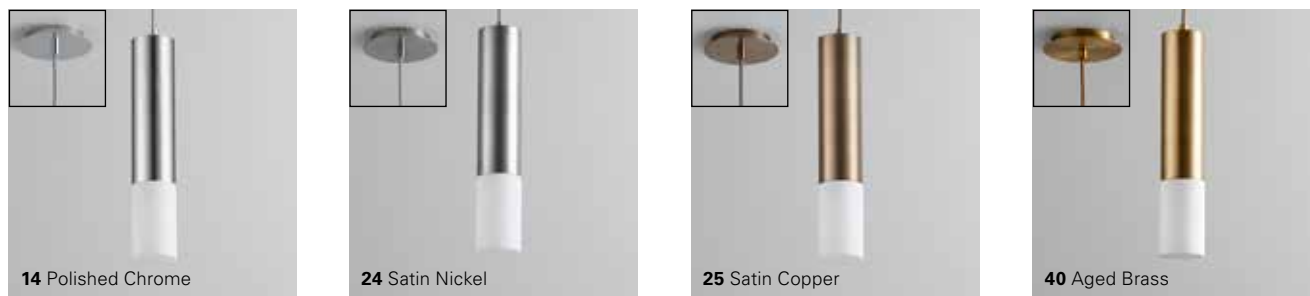

ITEM #	DIFFUSER	FINISH	DIMENSIONS	LAMPING	DRIVER	CERTIFICATION
3-654-XX	Matte White Acrylic	14 Polished Chrome 24 Satin Nickel 25 Satin Copper 40 Aged Brass	3.5"(w) x 18"(h)*	1 x 5.1w, 90CRI 3000k LED	120V 0-10V/Phase dimming	
37-654-XX	Matte White Acrylic	14 Polished Chrome 24 Satin Nickel 25 Satin Copper 40 Aged Brass	3.5"(w) x 18"(h)*	1 x 5.1w, 90CRI 3000k LED	277V 0-10V/Phase dimming	
3-654-1XX	1 Matte Opal Glass	14 Polished Chrome 24 Satin Nickel 25 Satin Copper 40 Aged Brass	3.5"(w) x 18"(h)*	1 x 5.1w, 90CRI 3000k LED	120V 0-10V/Phase dimming	
37-654-1XX	1 Matte Opal Glass	14 Polished Chrome 24 Satin Nickel 25 Satin Copper 40 Aged Brass	3.5"(w) x 18"(h)*	1 x 5.1w, 90CRI 3000k LED	277V 0-10V/Phase dimming	

2700k, 3500k, 4000k color temperatures also available. Contact Oxygen for ordering information.

PYRUS PENDANT

LED



PYRUS PENDANT



3-655-1314



3-655-2018



Multi-pendant canopy options. See page 276-277.

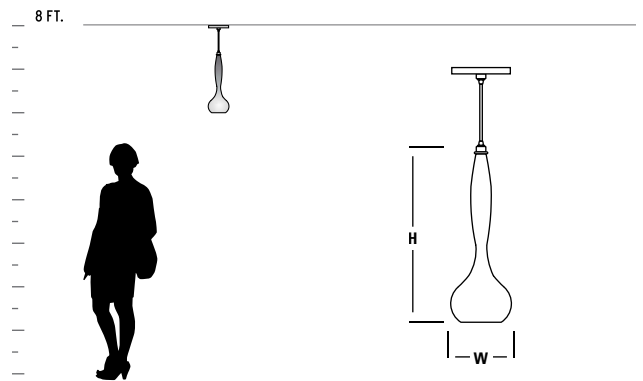

GENERAL SPECIFICATIONS:

- Cold rolled steel canopy. • Blown glass is 1/16" thick. • *Height measured not including adjustable cord or ceiling canopy. • Fixture supplied with 10' cord. • Unit mounts to 4" octagonal junction box. • Optional multi-pendant canopies available for 3, 5, and 7 lights. • Total luminaire power 6.6w. • Visit www.oxygenlighting.com for technical cut sheets. • Oxygen reserves the right to modify designs at any time.

AVAILABLE FINISHES



14 Polished Chrome



18 Gunmetal

ITEM #	DIFFUSER	FINISH	DIMENSIONS	LAMPING	DRIVER	CERTIFICATION
3-655-14	Clear Glass	14 Polished Chrome	6.25"(w) x 17.5"(h)*	1 x 5.1w, 90CRI 3000k LED	120V 0-10V/Phase dimming	
37-655-14	Clear Glass	14 Polished Chrome	6.25"(w) x 17.5"(h)*	1 x 5.1w, 90CRI 3000k LED	277V 0-10V/Phase dimming	
3-655-1314	13 Smoked Ombre Glass	14 Polished Chrome	6.25"(w) x 17.5"(h)*	1 x 5.1w, 90CRI 3000k LED	120V 0-10V/Phase dimming	
37-655-1314	13 Smoked Ombre Glass	14 Polished Chrome	6.25"(w) x 17.5"(h)*	1 x 5.1w, 90CRI 3000k LED	277V 0-10V/Phase dimming	
3-655-2018	20 Coffee Ombre Glass	18 Gunmetal	6.25"(w) x 17.5"(h)*	1 x 5.1w, 90CRI 3000k LED	120V 0-10V/Phase dimming	
37-655-2018	20 Coffee Ombre Glass	18 Gunmetal	6.25"(w) x 17.5"(h)*	1 x 5.1w, 90CRI 3000k LED	277V 0-10V/Phase dimming	

2700k, 3500k, 4000k color temperatures also available. Contact Oxygen for ordering information.

RUVO PENDANT

LED



3-6202-25

RUVO PENDANT

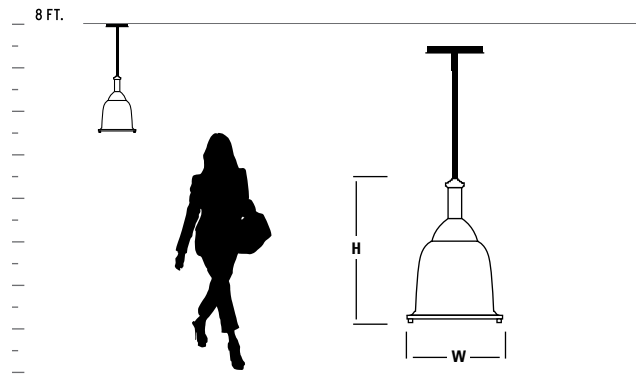

GENERAL SPECIFICATIONS:

- Cold rolled Steel Canopy. • White Tiffany glass diffuser. • *Height measured not including stem or ceiling canopy. • Stem is custom cut at oxygen facility to customer's specification (maximum stem length 60").
- Toolless lamp access. • Canopy swivel allows for mounting on sloped ceilings – up to 30-degrees. • Unit mounts to 4" octagonal junction box.
- Visit www.oxygenlighting.com for technical cut sheets. • Oxygen reserves the right to modify designs at any time.

AVAILABLE FINISHES



ITEM #	DIFFUSER	FINISH	DIMENSIONS	LAMPING	CERTIFICATION
3-6202-XX	Steel shade with White Tiffany glass	22 Oiled Bronze 24 Satin Nickel 25 Satin Copper	10.5"(w) x 16.5"(h)*	1 x 24w MAX PAR20/30/38, A21,A19 Medium Base 120V LED only (lamp not included)	

SIGMA PENDANT

LED



3-6204-24 & 3-6204-25

SIGMA PENDANT



3-6204-24

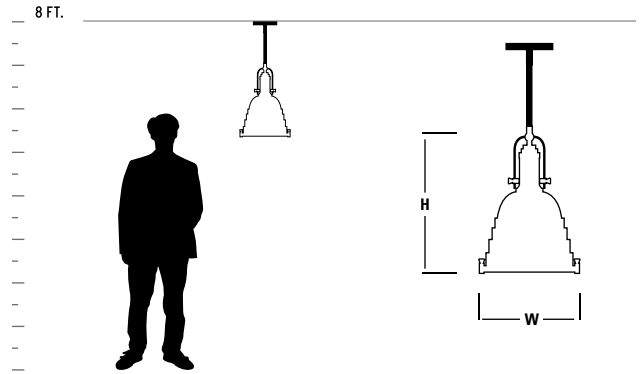

GENERAL SPECIFICATIONS:

- Cold rolled Steel Canopy. • White Tiffany glass diffuser. • *Height measured not including stem or ceiling canopy. • Stem is custom cut at oxygen facility to customer's specification (maximum stem length 60").
- Toolless lamp access. • Canopy swivel allows for mounting on sloped ceilings – up to 30-degrees. • Unit mounts to 4" octagonal junction box.
- Visit www.oxygenlighting.com for technical cut sheets. • Oxygen reserves the right to modify designs at any time.

AVAILABLE FINISHES





22 Oiled Bronze



24 Satin Nickel



25 Satin Copper

ITEM #	DIFFUSER	FINISH	DIMENSIONS	LAMPING	CERTIFICATION
3-6204-XX	Steel shade with White Tiffany glass	22 Oiled Bronze 24 Satin Nickel 25 Satin Copper	13.5"(w) x 18.25"(h)*	1 x 24w MAX PAR20/30/38, A21,A19 Medium Base 120V LED only (lamp not included)	 

SPINDLE PENDANT

LED



3-656-2018

SPINDLE PENDANT

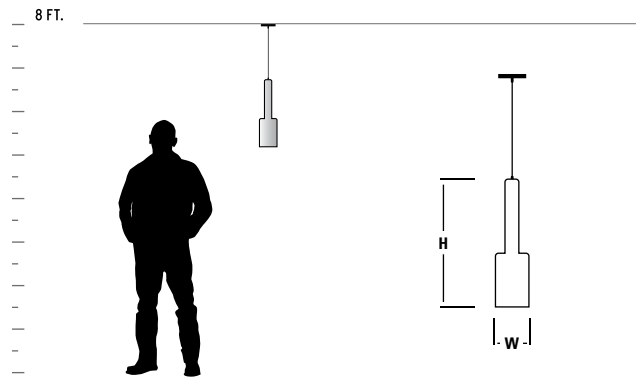
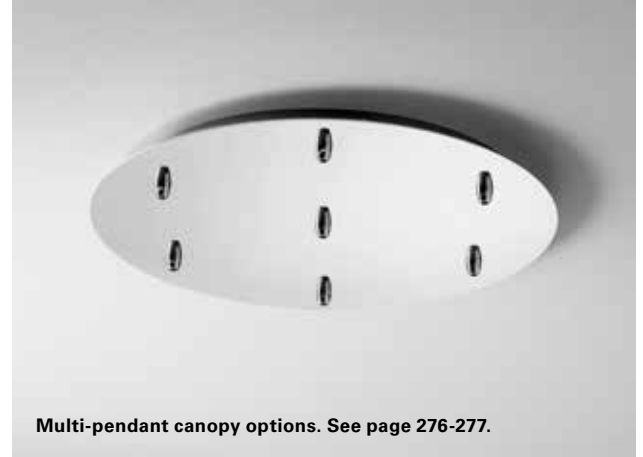

GENERAL SPECIFICATIONS:

- Cold rolled steel canopy. • Blown glass is 1/16" thick. • *Height measured not including adjustable cord or ceiling canopy. • Fixture supplied with 10' cord. • Unit mounts to 4" octagonal junction box.
- Optional multi-pendant canopies available for 3, 5, and 7 lights. • Total luminaire power 6.6w. • Visit www.oxygenlighting.com for technical cut sheets. • Oxygen reserves the right to modify designs at any time.

AVAILABLE FINISHES



ITEM #	DIFFUSER	FINISH	DIMENSIONS	LAMPING	DRIVER	CERTIFICATION
3-656-14	Clear Glass	14 Polished Chrome	5"(w) x 19"(h)*	1 x 5.1w, 90CRI 3000k LED	120V 0-10V/Phase dimming	
37-656-14	Clear Glass	14 Polished Chrome	5"(w) x 19"(h)*	1 x 5.1w, 90CRI 3000k LED	277V 0-10V/Phase dimming	
3-656-1314	13 Smoked Ombre Glass	14 Polished Chrome	5"(w) x 19"(h)*	1 x 5.1w, 90CRI 3000k LED	120V 0-10V/Phase dimming	
37-656-1314	13 Smoked Ombre Glass	14 Polished Chrome	5"(w) x 19"(h)*	1 x 5.1w, 90CRI 3000k LED	277V 0-10V/Phase dimming	
3-656-2018	20 Coffee Ombre Glass	18 Gunmetal	5"(w) x 19"(h)*	1 x 5.1w, 90CRI 3000k LED	120V 0-10V/Phase dimming	
37-656-2018	20 Coffee Ombre Glass	18 Gunmetal	5"(w) x 19"(h)*	1 x 5.1w, 90CRI 3000k LED	277V 0-10V/Phase dimming	

2700k, 3500k, 4000k color temperatures also available. Contact Oxygen for ordering information.

VIDA PENDANT

LED



3-6203-25

VIDA PENDANT

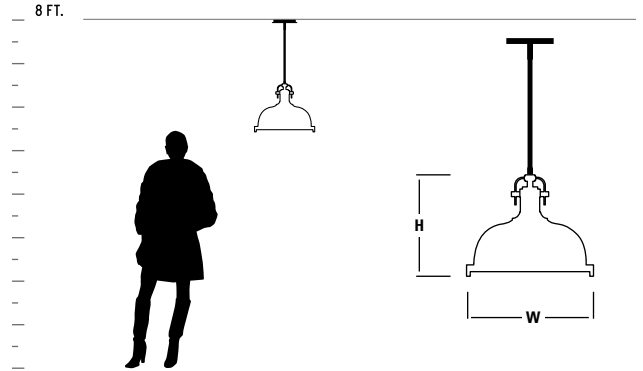



GENERAL SPECIFICATIONS:

- Cold rolled Steel Canopy. • White Tiffany glass diffuser. • *Height measured not including stem or ceiling canopy. • Stem is custom cut at oxygen facility to customer's specification (maximum stem length 60").
- Toolless lamp access. • Canopy swivel allows for mounting on sloped ceilings – up to 30-degrees. • Unit mounts to 4" octagonal junction box.
- Visit www.oxygenlighting.com for technical cut sheets • Oxygen reserves the right to modify designs at any time.



AVAILABLE FINISHES



ITEM #	DIFFUSER	FINISH	DIMENSIONS	LAMPING	CERTIFICATION
3-6203-XX	Steel shade with White Tiffany glass	22 Oiled Bronze 24 Satin Nickel 25 Satin Copper	16.5"(w) x 13"(h)*	1 x 24w MAX PAR20/30/38, A21,A19 Medium Base 120V LED only (lamp not included)	 

ZEPP PENDANT

LED



32-633-15

ZEPP PENDANT



32-632-20



32-632-24

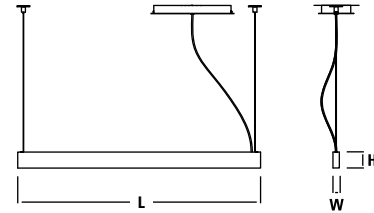
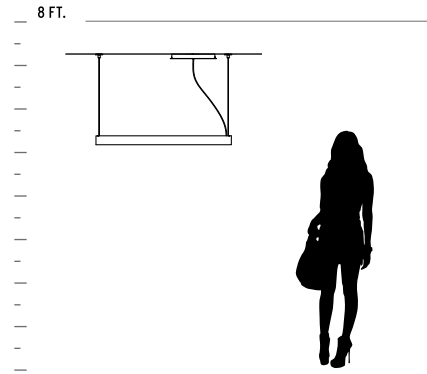

GENERAL SPECIFICATIONS:

- Cold rolled steel housing and canopy. • *Height measured not including adjustable cord or ceiling canopy. • Fixture supplied with 10' cord and 12.5' aircraft cable. • Unit mounts to 4" octagonal junction box. • Total luminaire power 38w for 32-632-XX and 56w for 32-633-XX. • Visit www.oxygenlighting.com for technical cut sheets. • Oxygen reserves the right to modify designs at any time.

AVAILABLE FINISHES







15 Black



20 Polished Nickel



24 Satin Nickel

ITEM #	DIFFUSER	FINISH	DIMENSIONS	LAMPING	DRIVER	CERTIFICATION
32-632-XX	Matte White Acrylic	15 Black 20 Polished Nickel 24 Satin Nickel	38"(l) x 1"(w) x 2.5"(h)	1 x 33w, 90CRI 3000k LED	120/277V 0-10V Dimming	 
32-633-XX	Matte White Acrylic	15 Black 20 Polished Nickel 24 Satin Nickel	50"(l) x 1"(w) x 2.5"(h)	2 x 25w, 90CRI 3000k LED	120/277V 0-10V Dimming	 

2700k, 3500k, 4000k color temperatures also available. Contact Oxygen for ordering information.

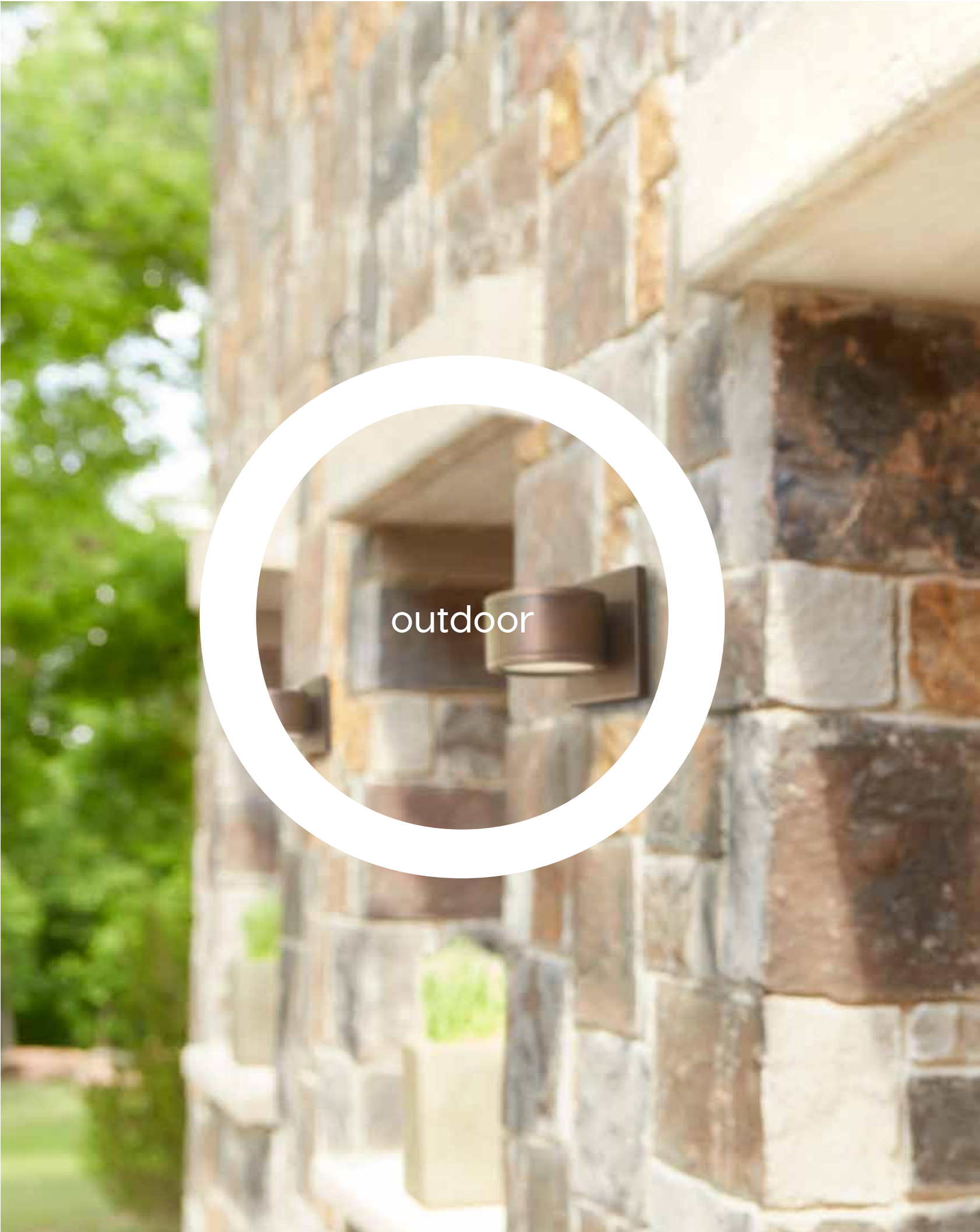

outdoor



CALYPSO SCONCE

ADA

LED



3-730-16

CALYPSO SCONCE

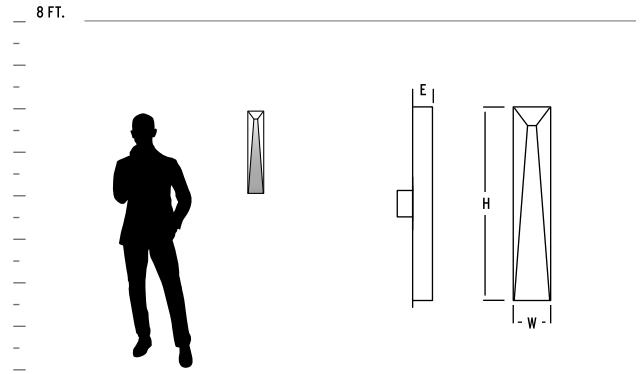

GENERAL SPECIFICATIONS:

- Cast aluminum housing. • Matte white polycarbonate diffuser is 1/16" thick. • Unit mounts to 4" octagonal, 4"x4" or 2"x3" junction box.
- Approved for wall mount applications. • Total luminaire power 13w for 3-730-XX/37-730-XX and 25.9w for 3-731-XX/37-731-XX.
- Visit www.oxygenlighting.com for technical cut sheets. • Oxygen reserves the right to modify designs at any time.

AVAILABLE FINISHES



ITEM #	DIFFUSER	FINISH	DIMENSIONS	LAMPING	DRIVER	CERTIFICATION
3-730-XX small	Polished White Polycarbonate	16 Gray 22 Oiled Bronze	4.25"(w) x 16.5"(h) x 2.25"(ext)	1 x 10.1w, 90CRI 3000k LED	120V 0-10V/Phase dimming	ADA COMPLIANT, ETL LISTED, ETL WET
37-730-XX small	Polished White Polycarbonate	16 Gray 22 Oiled Bronze	4.25"(w) x 16.5"(h) x 2.25"(ext)	1 x 10.1w, 90CRI 3000k LED	277V 0-10V/Phase dimming	ADA COMPLIANT, ETL LISTED, ETL WET
3-731-XX large	Polished White Polycarbonate	16 Gray 22 Oiled Bronze	4.25"(w) x 22"(h) x 2.25"(ext)	2 x 10.1w, 90CRI 3000k LED	120V 0-10V/Phase dimming	ADA COMPLIANT, ETL LISTED, ETL WET
37-731-XX large	Polished White Polycarbonate	16 Gray 22 Oiled Bronze	4.25"(w) x 22"(h) x 2.25"(ext)	2 x 10.1w, 90CRI 3000k LED	277V 0-10V/Phase dimming	ADA COMPLIANT, ETL LISTED, ETL WET

2700k, 3500k, 4000k color temperatures also available. Contact Oxygen for ordering information.

CELENA SCONCE

ADA

LED



3-715-16

CELENA SCONCE

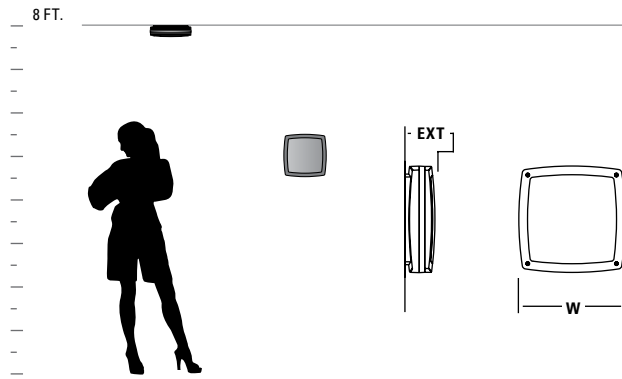

GENERAL SPECIFICATIONS:

- Cast aluminum housing.
- Injected molded polycarbonate diffuser.
- Captive, stainless steel, tamper resistant hardware.
- Vandal resistant construction.
- Unit mounts to 4" octagonal junction box.
- Approved for wall or ceiling mount applications.
- Total luminaire power 26w.
- Visit www.oxygenlighting.com for technical cut sheets.
- Oxygen reserves the right to modify designs at any time.

AVAILABLE FINISHES



ITEM #	DIFFUSER	FINISH	DIMENSIONS	LAMPING	DRIVER	CERTIFICATION
3-715-XX	Polished White Polycarbonate	15 Black 16 Gray	11.75"(w) x 3.5"(ext)	2 x 10.1w, 90CRI 3000k LED	120V 0-10V/Phase dimming	
37-715-XX	Polished White Polycarbonate	15 Black 16 Gray	11.75"(w) x 3.5"(ext)	2 x 10.1w, 90CRI 3000k LED	277V 0-10V/Phase dimming	

2700k, 3500k, 4000k color temperatures also available. Contact Oxygen for ordering information.

CERES SCONCE

LED



3-727-22

CERES SCONCE

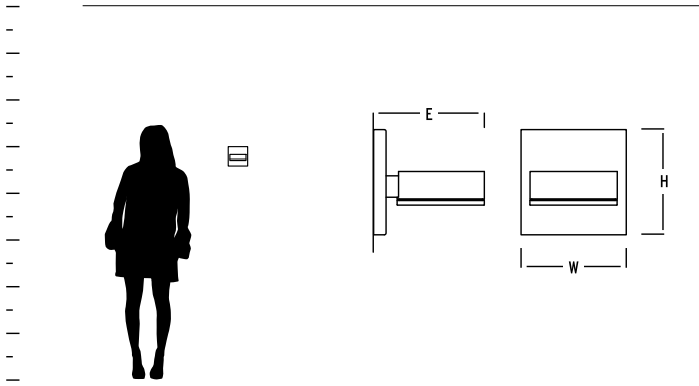

GENERAL SPECIFICATIONS:

- Cast aluminum housing.
- Frosted glass lenses.
- Unit mounts to 4" octagonal or 4"x4" junction box.
- Driver mounts inside junction box.
- Unit requires 2.5" deep junction box.
- Approved for wall mount application only.
- Approved for vertical and horizontal wall mount applications.
- Total luminaire power 10.3w for 3-726-XX/37-726-XX and 20.5w for 3-727-XX/37-727-XX.
- Visit www.oxygenlighting.com for technical cut sheets.
- Oxygen reserves the right to modify designs at any time.



AVAILABLE FINISHES

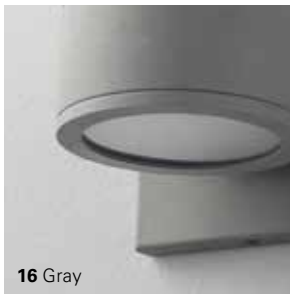

ITEM #	DIFFUSER	FINISH	DIMENSIONS	LAMPING	DRIVER	CERTIFICATION
3-726-XX	Frosted Glass	16 Gray 22 Oiled Bronze	4.75"(w) x 4.75"(h) x 5"(ext)	1 x 8.2w, 90CRI 3000k LED	120V 0-10V/Phase dimming	
37-726-XX	Frosted Glass	16 Gray 22 Oiled Bronze	4.75"(w) x 4.75"(h) x 5"(ext)	1 x 8.2w, 90CRI 3000k LED	277V 0-10V/Phase dimming	
3-727-XX	Frosted Glass	16 Gray 22 Oiled Bronze	4.75"(w) x 4.75"(h) x 5"(ext)	2 x 8.2w, 90CRI 3000k LED	120V 0-10V/Phase dimming	
37-727-XX	Frosted Glass	16 Gray 22 Oiled Bronze	4.75"(w) x 4.75"(h) x 5"(ext)	2 x 8.2w, 90CRI 3000k LED	277V 0-10V/Phase dimming	

2700k, 3500k, 4000k color temperatures also available. Contact Oxygen for ordering information.

DEVA SCONCE

ADA

LED



3-716-16

DEVA SCONCE

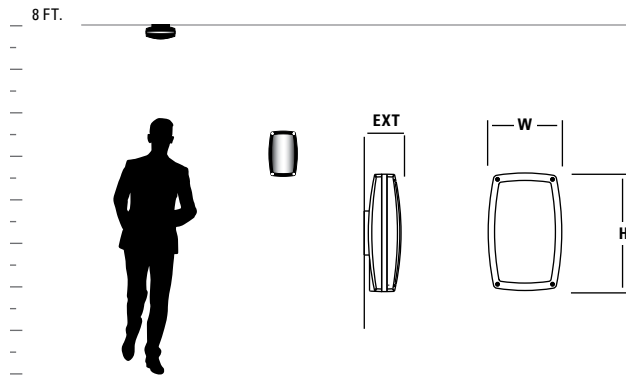

GENERAL SPECIFICATIONS:

- Cast aluminum housing. • Injected molded polycarbonate diffuser. • Captive, stainless steel, tamper resistant hardware. • Vandal resistant construction. • Unit mounts to 4" octagonal junction box. • Approved for wall or ceiling mount applications. • Total luminaire power 13.2w. • Visit www.oxygenlighting.com for technical cut sheets. • Oxygen reserves the right to modify designs at any time.

AVAILABLE FINISHES



ITEM #	DIFFUSER	FINISH	DIMENSIONS	LAMPING	DRIVER	CERTIFICATION
3-716-XX	Polished White Polycarbonate	15 Black 16 Gray	7.75"(w) x 12.5"(h) x 4"(ext)	1 x 10.1w, 90CRI 3000k LED	120V 0-10V/Phase dimming	ADA COMPLIANT, ETL US, ETL WET
37-716-XX	Polished White Polycarbonate	15 Black 16 Gray	7.75"(w) x 12.5"(h) x 4"(ext)	1 x 10.1w, 90CRI 3000k LED	277V 0-10V/Phase dimming	ADA COMPLIANT, ETL US, ETL WET

2700k, 3500k, 4000k color temperatures also available. Contact Oxygen for ordering information.

DUO SCONCE

ADA

LED



DUO SCONCE

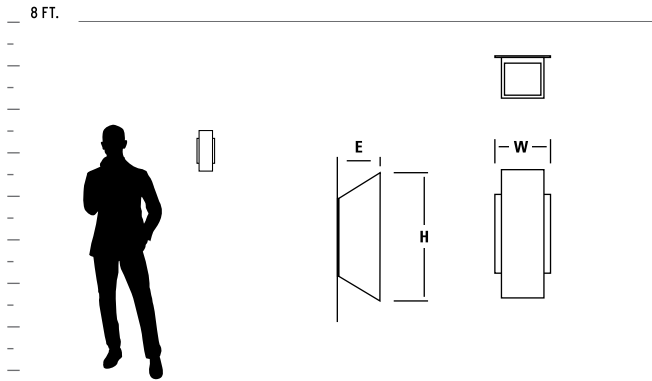

GENERAL SPECIFICATIONS:

- Cast aluminum housing. • Frosted glass lenses. • 3-702-XX mounts to 2"x3" junction box or 4" octagonal junction box. • 3-703-XX mounts to 4" junction box or 4" octagonal junction box.
- Approved for wall mount applications only. • Total luminaire power 20.3w for 3-702-XX/37-702-XX and 20.5w for 3-703-XX/37-703-XX. • Visit www.oxygenlighting.com for technical cut sheets.
- Oxygen reserves the right to modify designs at any time.

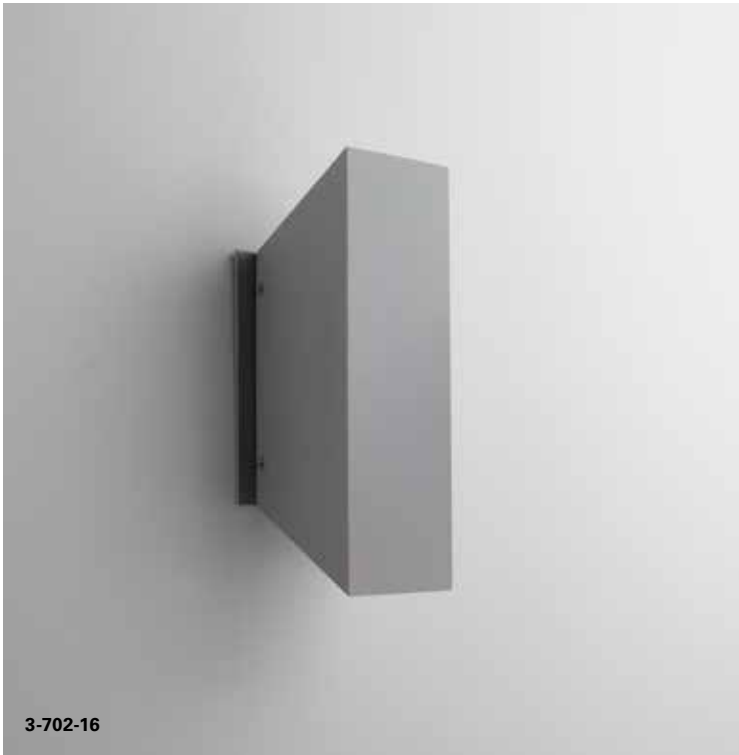

AVAILABLE FINISHES



ITEM #	DIFFUSER	FINISH	DIMENSIONS	LAMPING	DRIVER	CERTIFICATION
3-702-XX small	Frosted Glass	16 Gray 22 Oiled Bronze	5.25"(w) x 12.125"(h) x 4"(ext)	2 x 8.4w, 90CRI 3000k LED	120V 0-10V/Phase dimming	ADA COMPLIANT, ETL US, ETL wet
37-702-XX small	Frosted Glass	16 Gray 22 Oiled Bronze	5.25"(w) x 12.125"(h) x 4"(ext)	2 x 8.4w, 90CRI 3000k LED	277V 0-10V/Phase dimming	ADA COMPLIANT, ETL US, ETL wet
3-703-XX large	Frosted Glass	16 Gray 22 Oiled Bronze	6"(w) x 14"(h) x 6"(ext)	2 x 8.4w, 90CRI 3000k LED	120V 0-10V/Phase dimming	ETL US, ETL wet
37-703-XX large	Frosted Glass	16 Gray 22 Oiled Bronze	6"(w) x 14"(h) x 6"(ext)	2 x 8.4w, 90CRI 3000k LED	277V 0-10V/Phase dimming	ETL US, ETL wet

2700k, 3500k, 4000k color temperatures also available. Contact Oxygen for ordering information.

ECLIPSE SCONCE

LED



3-714-15

ECLIPSE SCONCE

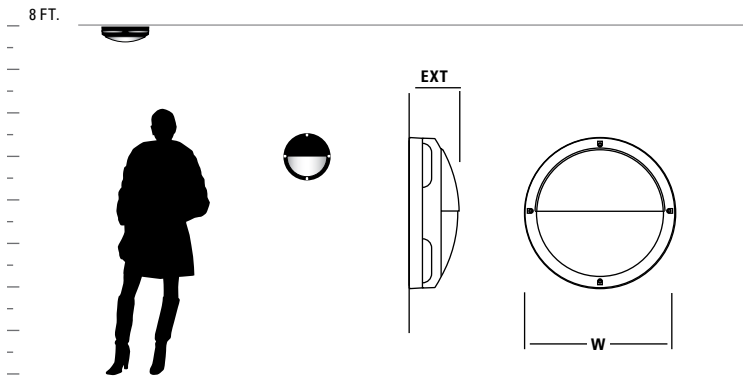

GENERAL SPECIFICATIONS:

- Cast aluminum housing.
- Injected molded polycarbonate diffuser.
- Captive, stainless steel, tamper resistant hardware.
- Vandal resistant construction.
- Unit mounts to 4" octagonal junction box.
- Approved for wall or ceiling mount applications.
- Total luminaire power 13.5w.
- Visit www.oxygenlighting.com for technical cut sheets.
- Oxygen reserves the right to modify designs at any time.



AVAILABLE FINISHES



ITEM #	DIFFUSER	FINISH	DIMENSIONS	LAMPING	DRIVER	CERTIFICATION
3-714-XX	Polished White Polycarbonate	15 Black 16 Gray	13"(w) x 4.25"(ext)	1 x 10.1w, 90CRI 3000k LED	120V 0-10V/Phase dimming	
37-714-XX	Polished White Polycarbonate	15 Black 16 Gray	13"(w) x 4.25"(ext)	1 x 10.1w, 90CRI 3000k LED	277V 0-10V/Phase dimming	

2700k, 3500k, 4000k color temperatures also available. Contact Oxygen for ordering information.

ELIF SCONCE

ADA

LED



3-736-16

ELIF SCONCE

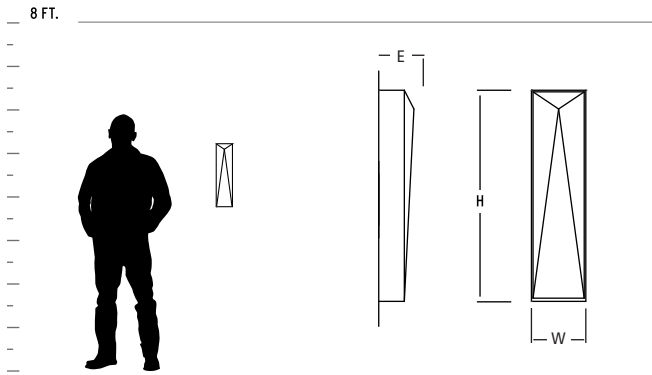

GENERAL SPECIFICATIONS:

- Cast aluminum housing.
- Matte white polycarbonate diffuser is 1/16" thick.
- Unit mounts to 4" octagonal, 4"x4" or 2"x3" junction box.
- Approved for wall mount applications.
- Total luminaire power 13w for 3-736-XX/37-736-XX and 25.7w for 3-737-XX/37-737-XX.
- Visit www.oxygenlighting.com for technical cut sheets.
- Oxygen reserves the right to modify designs at any time.



AVAILABLE FINISHES



ITEM #	DIFFUSER	FINISH	DIMENSIONS	LAMPING	DRIVER	CERTIFICATION
3-736-XX small	Polished White Polycarbonate	16 Gray 22 Oiled Bronze	4.25"(w) x 16.5"(h) x 2.75"(ext)	1 x 10.1w, 90CRI 3000k LED	120V 0-10V/Phase dimming	ADA COMPLIANT, ETL US, ETL wet
37-736-XX small	Polished White Polycarbonate	16 Gray 22 Oiled Bronze	4.25"(w) x 16.5"(h) x 2.75"(ext)	1 x 10.1w, 90CRI 3000k LED	277V 0-10V/Phase dimming	ADA COMPLIANT, ETL US, ETL wet
3-737-XX large	Polished White Polycarbonate	16 Gray 22 Oiled Bronze	4.25"(w) x 22"(h) x 2.75"(ext)	2 x 10.1w, 90CRI 3000k LED	120V 0-10V/Phase dimming	ADA COMPLIANT, ETL US, ETL wet
37-737-XX large	Polished White Polycarbonate	16 Gray 22 Oiled Bronze	4.25"(w) x 22"(h) x 2.75"(ext)	2 x 10.1w, 90CRI 3000k LED	277V 0-10V/Phase dimming	ADA COMPLIANT, ETL US, ETL wet

2700k, 3500k, 4000k color temperatures also available. Contact Oxygen for ordering information.

ERIS SCONCE

ADA

LED



3-721-16

ERIS SCONCE

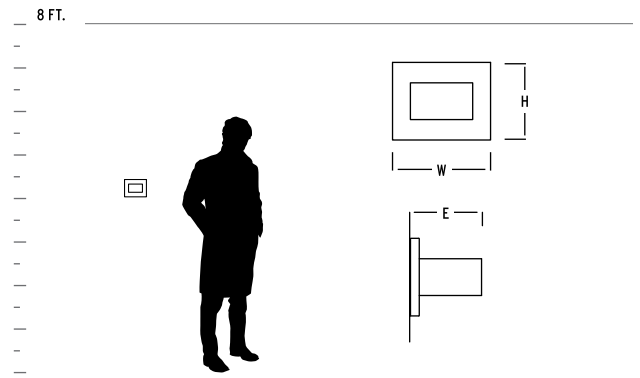

GENERAL SPECIFICATIONS:

- Cast aluminum housing. • Frosted glass lenses. • Unit mounts to 4" octagonal or 4"x4" junction box. • Driver mounts inside junction box. Unit requires 2.5" deep junction box. • Approved for wall mount application only.
- Approved for horizontal or vertical mounting. • Total luminaire power 10.4w for 3-720-XX/37-720-XX and 20.3w for 3-721-XX/37-721-XX. • Visit www.oxygenlighting.com for technical cut sheets. • Oxygen reserves the right to modify designs at any time.

AVAILABLE FINISHES

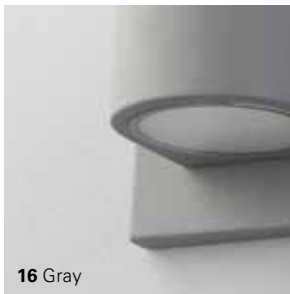

ITEM #	DIFFUSER	FINISH	DIMENSIONS	LAMPING	DRIVER	CERTIFICATION
3-720-XX	Frosted Glass	16 Gray 22 Oiled Bronze	6"(w) x 4.75"(h) x 4"(ext)	1 x 8.2w, 90CRI 3000k LED	120V 0-10V/Phase dimming	ADA COMPLIANT, ETL, ETL wet
37-720-XX	Frosted Glass	16 Gray 22 Oiled Bronze	6"(w) x 4.75"(h) x 4"(ext)	1 x 8.2w, 90CRI 3000k LED	277V 0-10V/Phase dimming	ADA COMPLIANT, ETL, ETL wet
3-721-XX	Frosted Glass	16 Gray 22 Oiled Bronze	6"(w) x 4.75"(h) x 4"(ext)	2 x 8.2w, 90CRI 3000k LED	120V 0-10V/Phase dimming	ADA COMPLIANT, ETL, ETL wet
37-721-XX	Frosted Glass	16 Gray 22 Oiled Bronze	6"(w) x 4.75"(h) x 4"(ext)	2 x 8.2w, 90CRI 3000k LED	277V 0-10V/Phase dimming	ADA COMPLIANT, ETL, ETL wet

2,700k, 3,500k, 4,000k color temperatures also available. Contact Oxygen for ordering information.

KARME SCONCE

ADA

LED



3-739-16

KARME SCONCE

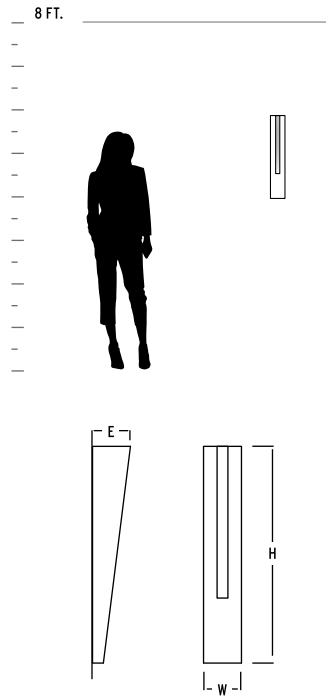

GENERAL SPECIFICATIONS:

- Cast aluminum housing. • Matte white polycarbonate diffuser is 1/16" thick. • Matte white acrylic lense • Unit mounts to 2" x 3" junction box.
- Approved for wall mount applications. • Total luminaire power 15.3w.
- Visit www.oxygenlighting.com for technical cut sheets. • Oxygen reserves the right to modify designs at any time.

AVAILABLE FINISHES



ITEM #	DIFFUSER	FINISH	DIMENSIONS	LAMPING	DRIVER	CERTIFICATION
3-739-XX	Matte White Acrylic	16 Gray 22 Oiled Bronze	3.5"(w) x 20"(h) x 3.5"(ext)	1 x 11.9w, 90CRI 3000k LED	120V 0-10V/Phase dimming	
37-739-XX	Matte White Acrylic	16 Gray 22 Oiled Bronze	3.5"(w) x 20"(h) x 3.5"(ext)	1 x 11.9w, 90CRI 3000k LED	277V 0-10V/Phase dimming	

2700k, 3500k, 4000k color temperatures also available. Contact Oxygen for ordering information.

LEDA SCONCE

LED

FLOURESCENT

EM



2-713-222

LEDA SCONCE



37-713-224

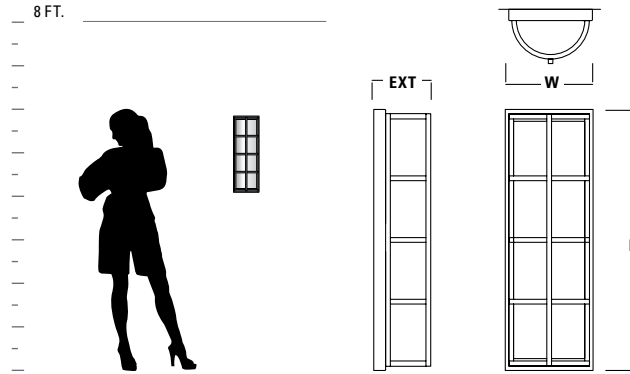

GENERAL SPECIFICATIONS:

Stainless steel housing. • White acrylic diffuser is extruded 1/8" thick. • Unit mounts to 4" octagonal, 4"x4" or 2"x3" junction box. • Approved for wall mount application only. • Approved for vertical mounting only. • Total luminaire power 13w for 3-712-XX/37-712-XX and 26w for 3-713-XX/37-713-XX. • Visit www.oxygenlighting.com for technical cut sheets. • Oxygen reserves the right to modify designs at any time.

EMERGENCY BATTERY BACKUP MODELS (EM)

• ETL required 90 minute emergency battery run time • 32 hour recharge time.

AVAILABLE FINISHES



22 Oiled Bronze



24 Satin Nickel

ITEM #	DIFFUSER	FINISH	DIMENSIONS	LAMPING	BALLAST	DRIVER	CERTIFICATION
2-712-224 small	Matte White Acrylic	24 Satin Nickel	7.25"(w) x 16.5"(h) x 4.75"(ext)	2 x 13w quad 4-pin fluorescent (G24q-1)	Electronic, HPF, Programmed Start, Universal Voltage (120-277V)	--	
2-713-224 large	Matte White Acrylic	24 Satin Nickel	7.25"(w) x 21.75"(h) x 4.75"(ext)	2 x 26w quad 4-pin fluorescent (G24q-3)	Electronic, HPF, Programmed Start, Universal Voltage (120-277V)	--	
3-712-2XX small	Matte White Acrylic	22 Oiled Bronze 24 Satin Nickel	7.25"(w) x 16.5"(h) x 4.75"(ext)	1 x 10.1w, 90CRI 3000k LED	--	120V 0-10V/Phase dimming	
37-712-2XX small	Matte White Acrylic	22 Oiled Bronze 24 Satin Nickel	7.25"(w) x 16.5"(h) x 4.75"(ext)	1 x 10.1w, 90CRI 3000k LED	--	277V 0-10V/Phase dimming	
3-712-2XX-EM small	Matte White Acrylic	22 Oiled Bronze 24 Satin Nickel	7.25"(w) x 16.5"(h) x 4.75"(ext)	1 x 10.1w, 90CRI 3000k LED	--	120V 0-10V/Phase dimming	
37-712-2XX-EM small	Matte White Acrylic	22 Oiled Bronze 24 Satin Nickel	7.25"(w) x 16.5"(h) x 4.75"(ext)	1 x 10.1w, 90CRI 3000k LED	--	277V 0-10V/Phase dimming	
3-713-2XX large	Matte White Acrylic	22 Oiled Bronze 24 Satin Nickel	7.25"(w) x 21.75"(h) x 4.75"(ext)	2 x 10.1w, 90CRI 3000k LED	--	120V 0-10V/Phase dimming	
37-713-2XX large	Matte White Acrylic	22 Oiled Bronze 24 Satin Nickel	7.25"(w) x 21.75"(h) x 4.75"(ext)	2 x 10.1w, 90CRI 3000k LED	--	277V 0-10V/Phase dimming	
3-713-2XX-EM large	Matte White Acrylic	22 Oiled Bronze 24 Satin Nickel	7.25"(w) x 21.75"(h) x 4.75"(ext)	2 x 10.1w, 90CRI 3000k LED	--	120V 0-10V/Phase dimming	
37-713-2XX-EM large	Matte White Acrylic	22 Oiled Bronze 24 Satin Nickel	7.25"(w) x 21.75"(h) x 4.75"(ext)	2 x 10.1w, 90CRI 3000k LED	--	277V 0-10V/Phase dimming	

2700k, 3500k, 4000k color temperatures also available for non EM LED models. Contact Oxygen for ordering information.

MAGNETA SCONCE

ADA

LED



37-728-16

MAGNETA SCONCE

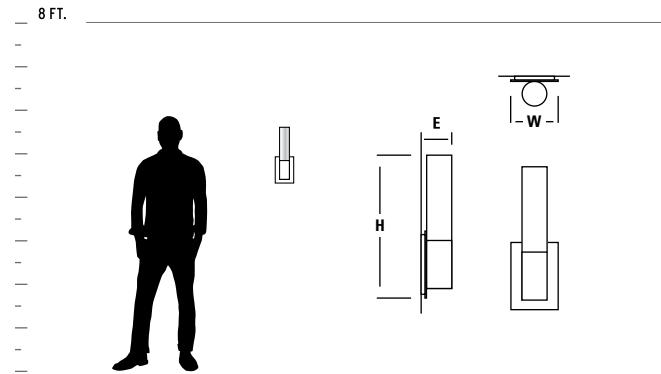

GENERAL SPECIFICATIONS:

- Cast aluminum housing • Diffuser is 1/8" thick matte opal glass. • Unit mounts to 4" octagonal junction box. • Approved for wall mount application only. • Total luminaire power 15.2w. • Visit www.oxygenlighting.com for technical cut sheets.
- Oxygen reserves the right to modify designs at any time.

AVAILABLE FINISHES



ITEM #	DIFFUSER	FINISH	DIMENSIONS	LAMPING	DRIVER	CERTIFICATION
3-728-XX	Matte Opal Glass	15 Black 16 Gray 22 Oiled Bronze	4.75"(w) x 14.5"(h) x 3.5"(ext)	1 x 11.9w, 90CRI 3000k LED	120V 0-10V/Phase dimming	
37-728-XX	Matte Opal Glass	15 Black 16 Gray 22 Oiled Bronze	4.75"(w) x 14.5"(h) x 3.5"(ext)	1 x 11.9w, 90CRI 3000k LED	277V 0-10V/Phase dimming	

2700k, 3500k, 4000k color temperatures also available. Contact Oxygen for ordering information.

MAIA SCONCE

ADA

LED



37-740-22

shown with optional cover plate (included)



3-742-22

shown with optional cover plate (included)

MAIA SCONCE

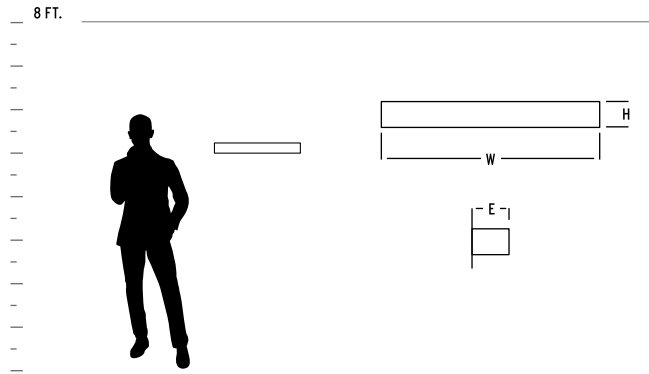



















GENERAL SPECIFICATIONS:

- Cast aluminum housing. • Matte white polycarbonate diffuser • Unit mounts to 2" x 3" junction box.
- Mounts to 4" octagonal junction box with optional cover plate. • Approved for vertical and horizontal wall mount applications. • Total luminaire power 13w for 3-740-XX/37-740-XX, 15.3w for 3-741-XX/37-741-XX, and 30.3 for 3-742-XX/37-742-XX. • Visit www.oxygenlighting.com for technical cut sheets.
- Oxygen reserves the right to modify designs at any time.



AVAILABLE FINISHES



ITEM #	DIFFUSER	FINISH	DIMENSIONS	LAMPING	DRIVER	CERTIFICATION
3-740-XX small	Matte White Acrylic	16 Gray 22 Oiled Bronze	11"(w) x 5"(h) x 4"(ext) w/ optional cover plate	1 x 10.1w, 90CRI 3000k LED	120V 0-10V/Phase dimming	  
37-740-XX small	Matte White Acrylic	16 Gray 22 Oiled Bronze	11"(w) x 5"(h) x 4"(ext) w/ optional cover plate	1 x 10.1w, 90CRI 3000k LED	277V 0-10V/Phase dimming	  
3-741-XX medium	Matte White Acrylic	16 Gray 22 Oiled Bronze	13"(w) x 5"(h) x 4"(ext) w/ optional cover plate	1 x 11.9w, 90CRI 3000k LED	120V 0-10V/Phase dimming	  
37-741-XX medium	Matte White Acrylic	16 Gray 22 Oiled Bronze	13"(w) x 5"(h) x 4"(ext) w/ optional cover plate	1 x 11.9w, 90CRI 3000k LED	277V 0-10V/Phase dimming	  
3-742-XX large	Matte White Acrylic	16 Gray 22 Oiled Bronze	24"(w) x 5"(h) x 4"(ext) w/ optional cover plate	2 x 11.9w, 90CRI 3000k LED	120V 0-10V/Phase dimming	  
37-742-XX large	Matte White Acrylic	16 Gray 22 Oiled Bronze	24"(w) x 5"(h) x 4"(ext) w/ optional cover plate	2 x 11.9w, 90CRI 3000k LED	277V 0-10V/Phase dimming	  

2700k, 3500k, 4000k color temperatures also available. Contact Oxygen for ordering information.

REALM SCONCE

LED



3-750-22

REALM SCONCE



3-750-16

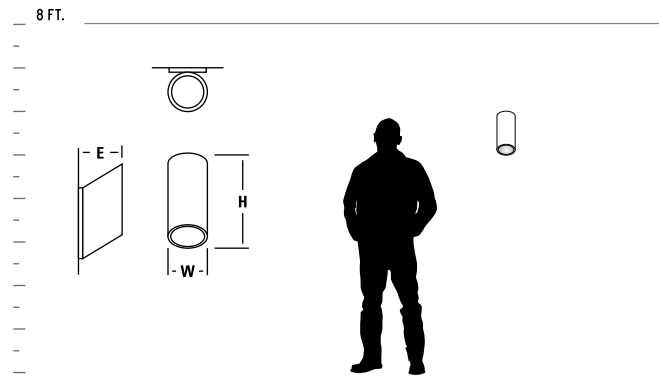

GENERAL SPECIFICATIONS:

- Cast aluminum housing. • Frosted glass lenses. • Unit mounts to 4" octagonal junction box.
- Approved for wall mount application only. • Total luminaire power 20.5w. • www.oxygenlighting.com for technical cut sheets. • Oxygen reserves the right to modify designs at any time.

AVAILABLE FINISHES



16 Gray



22 Oiled Bronze

ITEM #	DIFFUSER	FINISH	DIMENSIONS	LAMPING	DRIVER	CERTIFICATION
3-750-XX	Frosted Glass	16 Gray 22 Oiled Bronze	5"(w) x 12"(h) x 5.5"(ext)	2 x 8.4w, 90CRI 3000k LED	120V 0-10V/Phase dimming	
37-750-XX	Frosted Glass	16 Gray 22 Oiled Bronze	5"(w) x 12"(h) x 5.5"(ext)	2 x 8.4w, 90CRI 3000k LED	277V 0-10V/Phase dimming	

2700k, 3500k, 4000k color temperatures also available. Contact Oxygen for ordering information.

REGIO SCONCE

ADA

LED



3-719-16

REGIO SCONCE

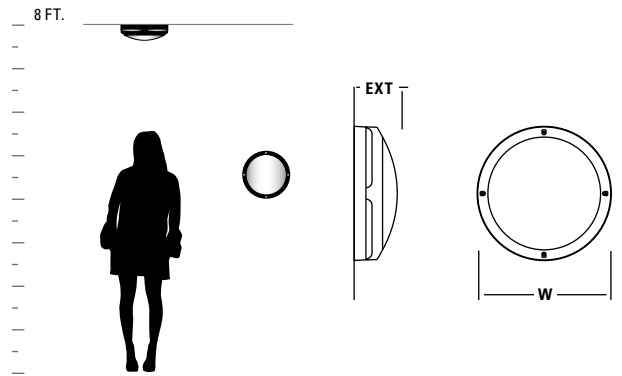

GENERAL SPECIFICATIONS:

- Cast aluminum housing. • Injected molded polycarbonate diffuser.
- Captive, stainless steel, tamper resistant hardware. • Vandal resistant construction. • Unit mounts to 4" octagonal junction box. • Approved for wall or ceiling mount applications. • Total luminaire power 26.2w.
- Visit www.oxygenlighting.com for technical cut sheets. • Oxygen reserves the right to modify designs at any time.

AVAILABLE FINISHES



ITEM #	DIFFUSER	FINISH	DIMENSIONS	LAMPING	DRIVER	CERTIFICATION
3-719-XX	Polished White Polycarbonate	15 Black 16 Gray	13"(w) x 4.25"(ext)	2 x 10.1w, 90CRI 3000k LED	120V 0-10V/Phase dimming	ETL US ETL wet
37-719-XX	Polished White Polycarbonate	15 Black 16 Gray	13"(w) x 4.25"(ext)	2 x 10.1w, 90CRI 3000k LED	277V 0-10V/Phase dimming	ETL US ETL wet

2700k, 3500k, 4000k color temperatures also available. Contact Oxygen for ordering information.

SCOPE SCONCE

LED



3-752-16

SCOPE SCONCE



37-752-22

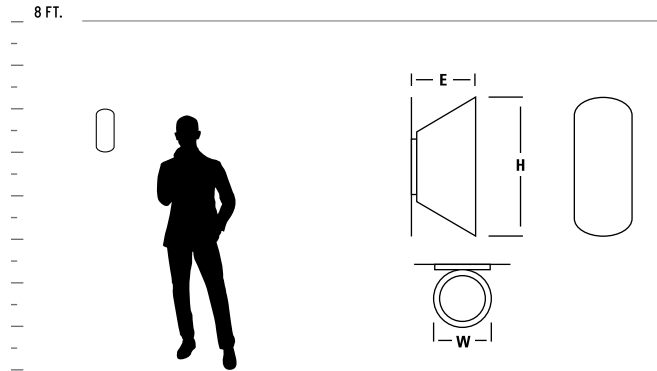

GENERAL SPECIFICATIONS:

- Cast aluminum housing.
- Frosted white lenses.
- Unit mounts to 4" junction box.
- Approved for wall mount application only.
- Total luminaire power 20.5w.
- Visit www.oxygenlighting.com for technical cut sheets.
- Oxygen reserves the right to modify designs at any time.

AVAILABLE FINISHES



16 Gray



22 Oiled Bronze

ITEM #	DIFFUSER	FINISH	DIMENSIONS	LAMPING	DRIVER	CERTIFICATION
3-752-XX	Frosted Glass	16 Gray 22 Oiled Bronze	5"(w) x 12"(h) x 5.5"(ext)	2 x 8.4w, 90CRI 3000k LED	120V 0-10V/Phase dimming	
37-752-XX	Frosted Glass	16 Gray 22 Oiled Bronze	5"(w) x 12"(h) x 5.5"(ext)	2 x 8.4w, 90CRI 3000k LED	277V 0-10V/Phase dimming	

2700k, 3500k, 4000k color temperatures also available. Contact Oxygen for ordering information.

TELSHOR SCONCE

LED

EM



3-711-224

TELSHOR SCONCE

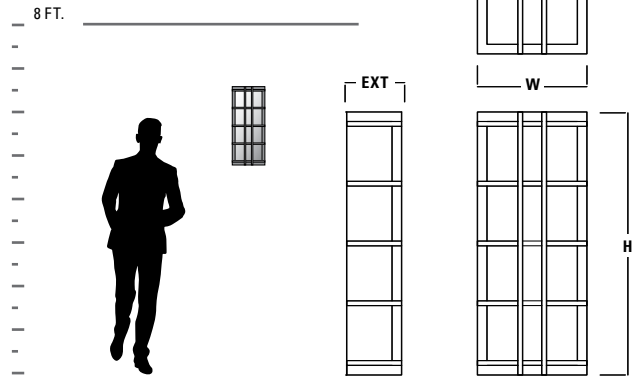

GENERAL SPECIFICATIONS:

- Stainless steel housing. • White acrylic diffuser is formed 1/8" thick. • Unit mounts to 4" octagonal, 4"x4" or 2"x3" junction box. • Approved for wall mount application only. • Approved for vertical mounting only. • Total luminaire power 13w for 3-710-XX/37-710-XX and 26w for 3-711-XX/37-711-XX. • Visit www.oxygenlighting.com for technical cut sheets. • Oxygen reserves the right to modify designs at any time.

EMERGENCY BATTERY BACKUP MODELS (EM)

- ETL required 90 minute emergency battery run time • 32 hour recharge time.

AVAILABLE FINISHES



ITEM #	DIFFUSER	FINISH	DIMENSIONS	LAMPING	DRIVER	CERTIFICATION
3-710-2XX small	2 Matte White Acrylic	22 Oiled Bronze 24 Satin Nickel	7.25"(w) x 16.5"(h) x 5"(ext)	1 x 10.1W, 90CRI 3000k LED	120V 0-10V/Phase dimming	
37-710-2XX small	2 Matte White Acrylic	22 Oiled Bronze 24 Satin Nickel	7.25"(w) x 16.5"(h) x 5"(ext)	1 x 10.1W, 90CRI 3000k LED	277V 0-10V/Phase dimming	
3-710-2XX-EM small	2 Matte White Acrylic	22 Oiled Bronze 24 Satin Nickel	7.25"(w) x 16.5"(h) x 5"(ext)	1 x 10.1W, 90CRI 3000k LED	120V 0-10V/Phase dimming	
37-710-2XX-EM small	2 Matte White Acrylic	22 Oiled Bronze 24 Satin Nickel	7.25"(w) x 16.5"(h) x 5"(ext)	1 x 10.1W, 90CRI 3000k LED	277V 0-10V/Phase dimming	
3-711-2XX large	2 Matte White Acrylic	22 Oiled Bronze 24 Satin Nickel	9"(w) x 21.75"(h) x 5"(ext)	2 x 10.1W, 90CRI 3000k LED	120V 0-10V/Phase dimming	
37-711-2XX large	2 Matte White Acrylic	22 Oiled Bronze 24 Satin Nickel	9"(w) x 21.75"(h) x 5"(ext)	2 x 10.1W, 90CRI 3000k LED	277V 0-10V/Phase dimming	
3-711-2XX-EM large	2 Matte White Acrylic	22 Oiled Bronze 24 Satin Nickel	9"(w) x 21.75"(h) x 5"(ext)	2 x 10.1W, 90CRI 3000k LED	120V 0-10V/Phase dimming	
37-711-2XX-EM large	2 Matte White Acrylic	22 Oiled Bronze 24 Satin Nickel	9"(w) x 21.75"(h) x 5"(ext)	2 x 10.1W, 90CRI 3000k LED	277V 0-10V/Phase dimming	

2700k, 3500k, 4000k color temperatures also available for non EM LED models. Contact Oxygen for ordering information.

UNO SCONCE

ADA

LED



3-700-22

3-701-16

UNO SCONCE

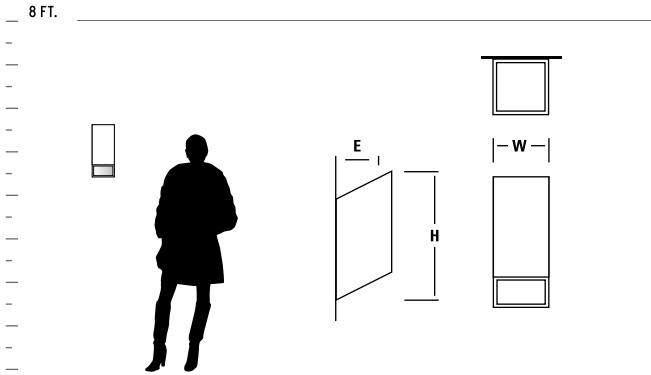

GENERAL SPECIFICATIONS:

- Cast aluminum housing. • Frosted glass lenses. • 3-700-XX/37-700-XX mounts 2"x3" or 4" octagonal junction box. • 3-701-XX/37-701-XX mounts 4"x4" or 4" octagonal junction box.
- Approved for wall mount application only. • Total luminaire power 10.3w for 3-700-XX/37-700-XX and 20.5w for 3-701-XX/37-701-XX. • Visit www.oxygenlighting.com for technical cut sheets. • Oxygen reserves the right to modify designs at any time.



AVAILABLE FINISHES



ITEM #	DIFFUSER	FINISH	DIMENSIONS	LAMPING	DRIVER	CERTIFICATION
3-700-XX small	Frosted Glass	16 Gray 22 Oiled Bronze	5.25"(w) x 9.25"(h) x 4"(ext)	1 x 8.4w, 90CRI 3000k LED	120V 0-10V/Phase dimming	ADA COMPLIANT c ETL us ETL wet
37-700-XX small	Frosted Glass	16 Gray 22 Oiled Bronze	5.25"(w) x 9.25"(h) x 4"(ext)	1 x 8.4w, 90CRI 3000k LED	277V 0-10V/Phase dimming	ADA COMPLIANT c ETL us ETL wet
3-701-XX large	Frosted Glass	16 Gray 22 Oiled Bronze	6"(w) x 14"(h) x 6"(ext)	2 x 8.4w, 90CRI 3000k LED	120V 0-10V/Phase dimming	c ETL us ETL wet
37-701-XX large	Frosted Glass	16 Gray 22 Oiled Bronze	6"(w) x 14"(h) x 6"(ext)	2 x 8.4w, 90CRI 3000k LED	277V 0-10V/Phase dimming	c ETL us ETL wet

2700k, 3500k, 4000k color temperatures also available. Contact Oxygen for ordering information.



accessories

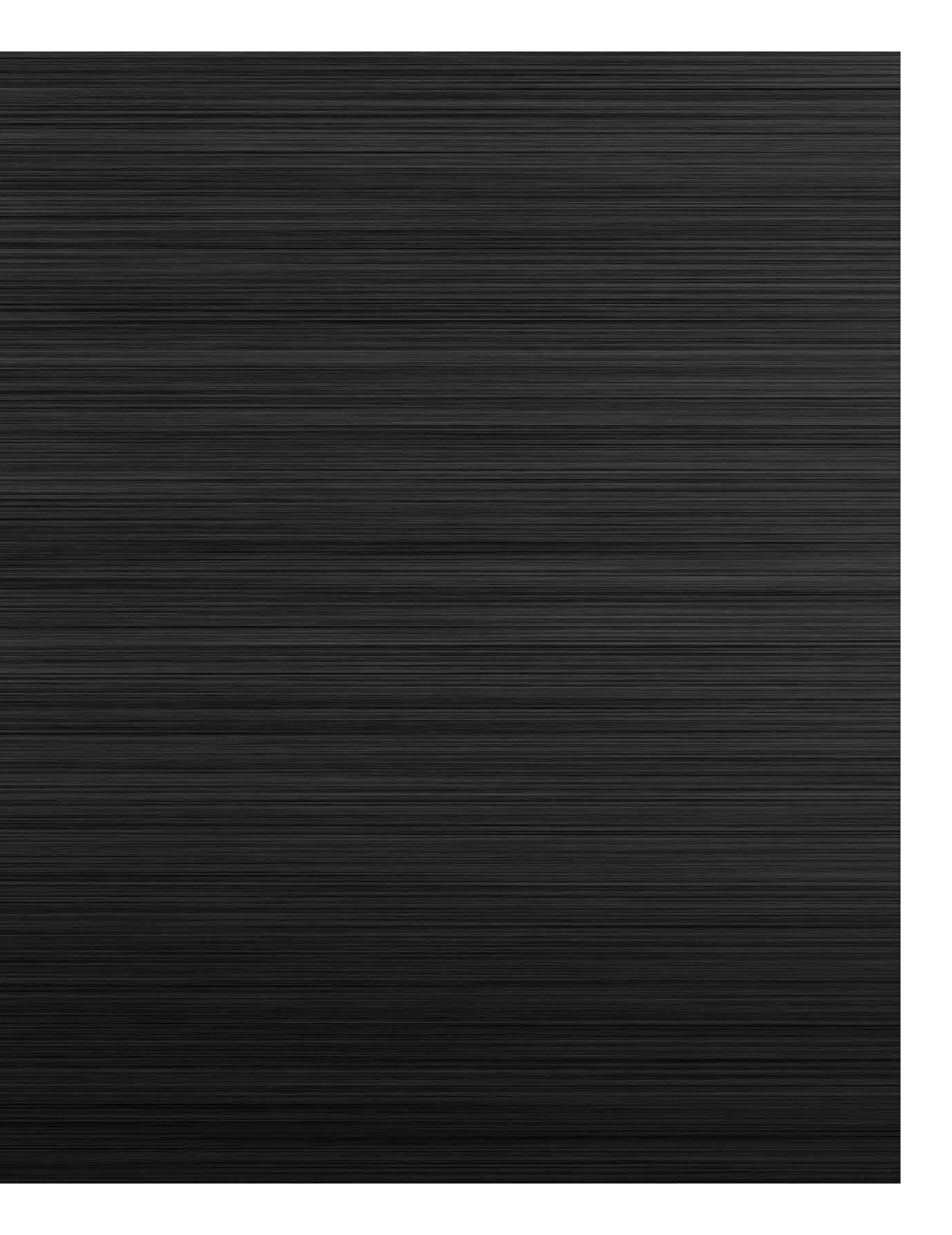

ACCESSORIES

GENERAL SPECIFICATIONS:

Multi-pendant canopies are available in assorted configurations that are compatible with the following pendant designs to create a stunning visual display.

• Comet • Cornet • Galaxy • Gratis • Idol • Liberty • Magneta • Magnum • Opus • Pyrus • Spindle





POLISHED CHROME

- 3-8-6714 - 7 light
- 3-8-6514 - 5 light (shown)
- 3-8-6314 - 3 light



POLISHED CHROME

- 3-8-7514 - 5 light (shown)
- 3-8-7314 - 3 light
- 3-8-7214 - 2 light



GUNMETAL

- 3-8-6718 - 7 light (shown)
- 3-8-6518 - 5 light
- 3-8-6318 - 3 light



GUNMETAL

- 3-8-7518 - 5 light
- 3-8-7318 - 3 light (shown)
- 3-8-7218 - 2 light



SATIN NICKEL

- 3-8-6724 - 7 light (shown)
- 3-8-6524 - 5 light
- 3-8-6324 - 3 light



SATIN NICKEL

- 3-8-7524 - 5 light
- 3-8-7324 - 3 light
- 3-8-7224 - 2 light (shown)



AGED BRASS

- 3-8-6740 - 7 light
- 3-8-6540 - 5 light
- 3-8-6340 - 3 light (shown)



AGED BRASS

- 3-8-7540 - 5 light (shown)
- 3-8-7340 - 3 light
- 3-8-7240 - 2 light

ACCESSORIES

OPTIONAL 1/2" DOWNRODS

These downrods allow you to choose how far your fan will hang from the ceiling. We offer a complete line of extension rods to match oxygen finishes. Remember your fan should always hang at least 7 feet above the floor.

DOWNROD FINISH	12"	18"	24"	36"	48"	60"	72"
White	3-6-1206	3-6-1806	3-6-2406	3-6-3606	3-6-4806	3-6-6006	3-6-7206
Polished Nickel	3-6-1220	3-6-1820	3-6-2420	3-6-3620	3-6-4820	3-6-6020	3-6-7220
Oiled Bronze	3-6-1222	3-6-1822	3-6-2422	3-6-3622	3-6-4822	3-6-6022	3-6-7222
Satin Nickel	3-6-1224	3-6-1824	3-6-2424	3-6-3624	3-6-4824	3-6-6024	3-6-7224



DIFFUSERS



white opal glass



matte white acrylic



smoked ombre glass



coffee ombre glass



clear glass



tobacco acrylic



silver cloth acrylic



white grass



mirrored glass

FINISHES



6 - white



14 - polished chrome

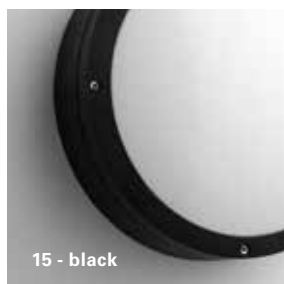

15 - black



16 - gray



18 - gunmetal



20 - polished nickel



22 - oiled bronze



24 - satin nickel



25 - satin copper



40 - aged brass



95 - old world

INDEX

item # pg #	item # pg #	item # pg #	item # pg #
2-597-124 47	2-5170-224 119	3-8-2000-0 27, 31	3-102-22 35
2-597-195 47	2-6107-24 215	3-8-6314 276	3-102-24 35
2-597-224 47	2-6109-24 177	3-8-6318 276	3-103-6 29
2-597-295 47	2-6110-24 177	3-8-6324 276	3-103-20 29
2-699-24 163	2-6114-24 165	3-8-6340 276	3-103-22 29
2-712-224 259	2-6134-24 165	3-8-6514 276	3-103-24 29
2-713-224 259	2-6135-24 165	3-8-6518 276	3-104-6 39
2-5104-14 121	2-6138-6 189	3-8-6524 276	3-104-20 39
2-5104-24 121	2-6139-6 189	3-8-6540 276	3-104-22 39
2-5105-14 121	2-6143-24 177	3-8-6714 276	3-104-24 39
2-5105-24 121	2-6143-24-EM 177	3-8-6718 276	3-105-06 27
2-5106-14 121	2-6209-24 209	3-8-6724 276	3-105-022 27
2-5106-24 121	3-6-1206 278	3-8-6740 276	3-105-024 27
2-5107-24 45	3-6-1220 278	3-8-7214 277	3-106-6 37
2-5113-224 91	3-6-1222 278	3-8-7218 277	3-106-22 37
2-5113-324 91	3-6-1224 278	3-8-7224 277	3-106-24 37
2-5113-624 91	3-6-1806 278	3-8-7240 277	3-308-115 183
2-5121-114 145	3-6-1820 278	3-8-7314 277	3-308-120 183
2-5121-124 145	3-6-1822 278	3-8-7318 277	3-308-124 183
2-5131-14 149	3-6-1824 278	3-8-7324 277	3-308-215 183
2-5131-24 149	3-6-2406 278	3-8-7340 277	3-308-220 183
2-5132-14 149	3-6-2420 278	3-8-7514 277	3-308-224 183
2-5132-24 149	3-6-2422 278	3-8-7518 277	3-309-115 183
2-5134-24 135	3-6-2424 278	3-8-7524 277	3-309-120 183
2-5137-24 129	3-6-3606 278	3-8-7540 277	3-309-124 183
2-5137-24-BP224 129	3-6-3620 278	3-8-61306 27	3-309-215 183
2-5138-24 129	3-6-3622 278	3-8-61322 27	3-309-220 183
2-5138-24-BP324 129	3-6-3624 278	3-8-61324 27	3-309-224 183
2-5145-124 49	3-6-4806 278	3-9-100 31	3-353-115 161
2-5145-224 49	3-6-4820 278	3-9-101 33, 35	3-353-120 161
2-5145-524 49	3-6-4822 278	3-9-102 29, 39	3-353-124 161
2-5146-124 51	3-6-4824 278	3-100-6 31	3-353-215 161
2-5146-224 51	3-6-6006 278	3-100-20 31	3-353-220 161
2-5154-124 65	3-6-6020 278	3-100-22 31	3-353-224 161
2-5154-224 65	3-6-6022 278	3-100-24 31	3-354-115 161
2-5156-124 93	3-6-6024 278	3-101-6 33	3-354-120 161
2-5159-124 57	3-6-7206 278	3-101-20 33	3-354-124 161
2-5167-14 151	3-6-7220 278	3-101-22 33	3-354-215 161
2-5167-24 151	3-6-7222 278	3-101-24 33	3-354-220 161
2-5169-14 151	3-6-7224 278	3-102-6 35	3-354-224 161
2-5169-24 151	3-8-1000-0 , 33	3-102-20 35	3-500-14 105

INDEX

item # pg #	item # pg #	item # pg #	item # pg #
3-500-18 105	3-518-40 75	3-528-24 73	3-549-20 131
3-500-24 105	3-518-114 75	3-528-40 73	3-549-20-BP420 . 131
3-500-25 105	3-518-124 75	3-528-114 73	3-549-24 131
3-500-40 105	3-518-125 75	3-528-124 73	3-549-24-BP424 . 131
3-504-14 99	3-518-140 75	3-528-140 73	3-550-22 83
3-504-24 99	3-519-20 107	3-530-22 113	3-550-24 83
3-504-25 99	3-519-24 107	3-530-24 113	3-550-40 83
3-504-40 99	3-520-14 79	3-530-40 113	3-552-20 127
3-509-14 61	3-520-24 79	3-532-22 43	3-552-24 127
3-509-18 61	3-520-25 79	3-532-24 43	3-557-14 153
3-509-24 61	3-520-40 79	3-532-40 43	3-557-22 153
3-509-25 61	3-521-14 53	3-534-20 147	3-557-24 153
3-509-40 61	3-521-22 53	3-534-24 147	3-557-40 153
3-511-14 69	3-521-24 53	3-535-14 67	3-559-14 153
3-511-22 69	3-521-40 53	3-535-24 67	3-559-22 153
3-511-24 69	3-522-24 95	3-535-25 67	3-559-24 153
3-511-25 69	3-522-24-EM 95	3-535-40 67	3-559-40 153
3-511-40 69	3-523-224 91	3-536-22 119	3-560-22 111
3-512-14 59	3-523-224-EM 91	3-536-24 119	3-560-24 111
3-512-24 59	3-523-295 91	3-536-40 119	3-560-40 111
3-512-25 59	3-523-295-EM 91	3-537-22 119	3-563-114 101
3-513-14 59	3-523-324 91	3-537-24 119	3-563-124 101
3-513-24 59	3-523-395 91	3-537-40 119	3-563-214 101
3-513-25 59	3-523-624 91	3-538-22 85	3-563-224 101
3-514-14 55	3-523-695 91	3-538-24 85	3-564-122 65
3-514-22 55	3-524-14 123	3-539-22 87	3-564-124 65
3-514-24 55	3-524-22 123	3-539-24 87	3-564-140 65
3-514-40 55	3-524-24 123	3-540-14 89	3-564-222 65
3-515-14 67	3-524-40 123	3-540-24 89	3-564-224 65
3-515-24 67	3-525-14 123	3-540-40 89	3-564-240 65
3-515-25 67	3-525-22 123	3-541-20 77	3-570-24 45
3-515-40 67	3-525-24 123	3-541-24 77	3-571-20 117
3-516-14 81	3-525-40 123	3-542-20 143	3-571-24 117
3-516-24 81	3-526-14 123	3-542-24 143	3-575-20 125
3-516-25 81	3-526-22 123	3-544-24 135	3-575-24 125
3-516-40 81	3-526-24 123	3-545-20 71	3-582-14 133
3-517-14 97	3-526-40 123	3-545-24 71	3-582-24 133
3-517-24 97	3-527-20 109	3-547-20 131	3-587-124 47
3-518-14 75	3-527-22 109	3-547-20-BP220 . 131	3-587-195 47
3-518-24 75	3-527-24 109	3-547-24 131	3-587-224 47
3-518-25 75	3-528-14 73	3-547-24-BP224 . 131	3-587-295 47

INDEX

item # pg #	item # pg #	item # pg #	item # pg #
3-588-14	141	3-609-2018	205
3-588-24	141	3-610-22	185
3-588-25	141	3-610-24	185
3-588-40	141	3-610-40	185
3-588-114	141	3-618-14	173
3-588-124	141	3-618-22	173
3-588-125	141	3-618-24	173
3-588-140	141	3-618-40	173
3-589-114	103	3-619-14	173
3-589-124	103	3-619-14-EM	175
3-589-214	103	3-619-22	173
3-589-224	103	3-619-22-EM	175
3-589-614	103	3-619-24	173
3-589-624	103	3-619-24-EM	175
3-590-14	139	3-619-40	173
3-590-24	139	3-619-40-EM	175
3-590-40	139	3-620-14	173
3-590-114	139	3-620-14-EM	175
3-590-124	139	3-620-22	173
3-590-140	139	3-620-22-EM	175
3-593-14	137	3-620-24	173
3-593-24	137	3-620-24-EM	175
3-600-22	179	3-620-40	173
3-600-24	179	3-620-40-EM	175
3-600-40	179	3-622-24	167
3-607-14	219	3-623-14	167
3-607-24	219	3-623-14-EM	169
3-607-40	219	3-623-24	167
3-607-114	219	3-623-24-EM	169
3-607-124	219	3-624-14	167
3-607-140	219	3-624-24	167
3-608-14	221	3-625-24	167
3-608-24	221	3-625-24-EM	169
3-608-40	221	3-626-14	167
3-608-114	221	3-626-24	167
3-608-124	221	3-634-14	203
3-608-140	221	3-634-1314	203
3-609-14	205	3-634-1414	203
3-609-124	205	3-634-2018	203
3-609-1314	205	3-635-14	207
3-609-1414	205	3-635-18	207
		3-635-24	207
		3-638-22	199
		3-638-24	199
		3-639-22	199
		3-639-24	199
		3-640-22	199
		3-640-24	199
		3-648-6	189
		3-649-6	189
		3-650-14	193
		3-650-1314	193
		3-650-2018	193
		3-651-14	195
		3-651-1314	195
		3-651-2018	195
		3-652-14	213
		3-652-1314	213
		3-652-2018	213
		3-653-14	223
		3-653-24	223
		3-653-25	223
		3-653-40	223
		3-653-114	223
		3-653-124	223
		3-653-125	223
		3-653-140	223
		3-654-14	225
		3-654-24	225
		3-654-25	225
		3-654-40	225
		3-654-114	225
		3-654-124	225
		3-654-125	225
		3-654-140	225
		3-655-14	227
		3-655-1314	227
		3-655-2018	227
		3-656-14	233
		3-656-1314	233
		3-656-2018	233
		3-670-20	217
		3-670-22	217
		3-670-24	217
		3-670-40	217
		3-671-20	217
		3-671-22	217
		3-671-24	217
		3-671-40	217
		3-672-20	217
		3-672-22	217
		3-672-24	217
		3-672-40	217
		3-673-20	217
		3-673-22	217
		3-673-24	217
		3-673-40	217
		3-682-24	171
		3-682-24-EM	171
		3-682-40	171
		3-682-40-EM	171
		3-683-24	171
		3-683-24-EM	171
		3-683-40	171
		3-683-40-EM	171
		3-689-24	163
		3-689-24-EM	163
		3-689-40	163
		3-689-40-EM	163
		3-694-24	159
		3-694-24-EM	159
		3-695-22	159
		3-695-22-EM	159
		3-695-24	159
		3-695-24-EM	159
		3-700-16	273
		3-700-22	273
		3-701-16	273
		3-701-22	273
		3-702-16	249
		3-702-22	249
		3-703-16	249
		3-703-22	249

INDEX

item #. pg #	item #. pg #	item #. pg #	item #. pg #
3-710-222 271	3-737-16 253	32-612-40 187	37-511-24 69
3-710-222-EM . . . 271	3-737-22 253	32-632-15 237	37-511-25 69
3-710-224 271	3-739-16 257	32-632-20 237	37-511-40 69
3-710-224-EM . . . 271	3-739-22 257	32-632-24 237	37-512-14 59
3-711-222 271	3-740-16 263	32-633-15 237	37-512-24 59
3-711-222-EM . . . 271	3-740-22 263	32-633-20 237	37-512-25 59
3-711-224 271	3-741-16 263	32-633-24 237	37-513-14 59
3-711-224-EM . . . 271	3-741-22 263	32-642-15 211	37-513-24 59
3-712-222 259	3-742-16 263	32-642-20 211	37-513-25 59
3-712-222-EM . . . 259	3-742-22 263	32-642-24 211	37-514-14 55
3-712-224 259	3-750-16 265	32-660-24 197	37-514-22 55
3-712-224-EM . . . 259	3-750-22 265	32-661-24 197	37-514-24 55
3-713-222 259	3-752-16 269	32-664-24 157	37-514-40 55
3-713-222-EM . . . 259	3-752-22 269	32-665-24 157	37-515-14 67
3-713-224 259	3-5110-14 63	32-665-24-EM . . . 157	37-515-24 67
3-713-224-EM . . . 259	3-5110-24 63	37-308-115 183	37-515-25 67
3-714-15 251	3-5120-14 63	37-308-120 183	37-515-40 67
3-714-16 251	3-5120-24 63	37-308-124 183	37-516-14 81
3-715-15 243	3-6202-22 229	37-308-215 183	37-516-24 81
3-715-16 243	3-6202-24 229	37-308-220 183	37-516-25 81
3-716-15 247	3-6202-25 229	37-308-224 183	37-516-40 81
3-716-16 247	3-6203-22 235	37-309-115 183	37-517-14 97
3-719-15 267	3-6203-24 235	37-309-120 183	37-517-24 97
3-719-16 267	3-6203-25 235	37-309-124 183	37-518-14 75
3-720-16 255	3-6204-22 231	37-309-215 183	37-518-24 75
3-720-22 255	3-6204-24 231	37-309-220 183	37-518-25 75
3-721-16 255	3-6204-25 231	37-309-224 183	37-518-40 75
3-721-22 255	3-8110-14 201	37-353-115 161	37-518-114 75
3-726-16 245	3-8110-24 201	37-353-120 161	37-518-124 75
3-726-22 245	3-8120-14 201	37-353-124 161	37-518-125 75
3-727-16 245	3-8120-24 201	37-353-215 161	37-518-140 75
3-727-22 245	3-8130-14 201	37-353-220 161	37-519-20 107
3-728-15 261	3-8130-24 201	37-353-224 161	37-519-24 107
3-728-16 261	32-601-20 181	37-354-115 161	37-520-14 79
3-728-22 261	32-601-20-EM . . . 181	37-354-120 161	37-520-24 79
3-730-16 241	32-601-24 181	37-354-124 161	37-520-25 79
3-730-22 241	32-601-24-EM . . . 181	37-354-215 161	37-520-40 79
3-731-16 241	32-601-40 181	37-354-220 161	37-521-14 53
3-731-22 241	32-601-40-EM . . . 181	37-354-224 161	37-521-22 53
3-736-16 253	32-612-20 187	37-511-14 69	37-521-24 53
3-736-22 253	32-612-24 187	37-511-22 69	37-521-40 53

INDEX

item # pg #	item # pg #	item # pg #	item # pg #
37-522-24 95	37-535-25 67	37-559-24 153	37-590-24 139
37-522-24-EM 95	37-535-40 67	37-559-40 153	37-590-40 139
37-523-224 91	37-536-22 119	37-560-22 111	37-590-114 139
37-523-224-EM 91	37-536-24 119	37-560-24 111	37-590-124 139
37-523-295 91	37-536-40 119	37-560-40 111	37-590-140 139
37-523-295-EM 91	37-537-22 119	37-563-114 101	37-593-14 137
37-523-324 91	37-537-24 119	37-563-124 101	37-593-24 137
37-523-395 91	37-537-40 119	37-563-214 101	37-600-22 179
37-523-624 91	37-538-22 85	37-563-224 101	37-600-24 179
37-523-695 91	37-538-24 85	37-564-122 65	37-600-40 179
37-524-14 123	37-539-22 87	37-564-124 65	37-607-14 219
37-524-22 123	37-539-24 87	37-564-140 65	37-607-24 219
37-524-24 123	37-540-14 89	37-564-222 65	37-607-40 219
37-524-40 123	37-540-24 89	37-564-224 65	37-607-114 219
37-525-14 123	37-540-40 89	37-564-240 65	37-607-124 219
37-525-22 123	37-541-20 77	37-570-24 45	37-607-140 219
37-525-24 123	37-541-24 77	37-571-20 117	37-608-14 221
37-525-40 123	37-542-20 143	37-571-24 117	37-608-24 221
37-526-14 123	37-542-24 143	37-575-20 125	37-608-40 221
37-526-22 123	37-544-24 135	37-575-24 125	37-608-114 221
37-526-24 123	37-545-20 71	37-582-14 133	37-608-124 221
37-526-40 123	37-545-24 71	37-582-24 133	37-608-140 221
37-527-20 109	37-547-20 131	37-587-124 47	37-609-14 205
37-527-22 109	37-547-20-BP220 131	37-587-195 47	37-609-124 205
37-527-24 109	37-547-24 131	37-587-224 47	37-609-1314 205
37-528-14 73	37-547-24-BP224 131	37-587-295 47	37-609-1414 205
37-528-24 73	37-549-20 131	37-588-14 141	37-609-2018 205
37-528-40 73	37-549-20-BP420 131	37-588-24 141	37-610-22 185
37-528-114 73	37-549-24 131	37-588-25 141	37-610-24 185
37-528-124 73	37-549-24-BP424 131	37-588-40 141	37-610-40 185
37-528-140 73	37-550-22 83	37-588-114 141	37-618-14 173
37-530-22 113	37-550-24 83	37-588-124 141	37-618-22 173
37-530-24 113	37-550-40 83	37-588-125 141	37-618-24 173
37-530-40 113	37-552-20 127	37-588-140 141	37-618-40 173
37-532-22 43	37-552-24 127	37-589-114 103	37-619-14 173
37-532-24 43	37-557-14 153	37-589-124 103	37-619-14-EM 175
37-532-40 43	37-557-22 153	37-589-214 103	37-619-22 173
37-534-20 147	37-557-24 153	37-589-224 103	37-619-22-EM 175
37-534-24 147	37-557-40 153	37-589-614 103	37-619-24 173
37-535-14 67	37-559-14 153	37-589-624 103	37-619-24-EM 175
37-535-24 67	37-559-22 153	37-590-14 139	37-619-40 173

INDEX

item #. pg #	item #. pg #	item #. pg #	item #. pg #
37-619-40-EM . . . 175	37-652-14 213	37-682-24 171	37-713-224-EM . . 259
37-620-14 173	37-652-1314 213	37-682-24-EM . . . 171	37-714-15 251
37-620-14-EM . . . 175	37-652-2018 213	37-682-40 171	37-714-16 251
37-620-22 173	37-653-14 223	37-682-40-EM . . . 171	37-715-15 243
37-620-22-EM . . . 175	37-653-24 223	37-683-24 171	37-715-16 243
37-620-24 173	37-653-25 223	37-683-24-EM . . . 171	37-716-15 247
37-620-24-EM . . . 175	37-653-40 223	37-683-40 171	37-716-16 247
37-620-40 173	37-653-114 223	37-683-40-EM . . . 171	37-719-15 267
37-620-40-EM . . . 175	37-653-124 223	37-689-24 163	37-719-16 267
37-622-24 167	37-653-125 223	37-689-24-EM . . . 163	37-720-16 255
37-623-14 167	37-653-140 223	37-689-40 163	37-720-22 255
37-623-14-EM . . . 169	37-654-14 225	37-689-40-EM . . . 163	37-721-16 255
37-623-24 167	37-654-24 225	37-694-24 159	37-721-22 255
37-623-24-EM . . . 169	37-654-25 225	37-694-24-EM . . . 159	37-726-16 245
37-624-14 167	37-654-40 225	37-695-22 159	37-726-22 245
37-624-24 167	37-654-114 225	37-695-22-EM . . . 159	37-727-16 245
37-625-24 167	37-654-124 225	37-695-24 159	37-727-22 245
37-625-24-EM . . . 169	37-654-125 225	37-695-24-EM . . . 159	37-728-15 261
37-626-14 167	37-654-140 225	37-700-16 273	37-728-16 261
37-626-24 167	37-655-14 227	37-700-22 273	37-728-22 261
37-634-14 203	37-655-1314 227	37-701-16 273	37-730-16 241
37-634-1314 203	37-655-2018 227	37-701-22 273	37-730-22 241
37-634-1414 203	37-656-14 233	37-702-16 249	37-731-16 241
37-634-2018 203	37-656-1314 233	37-702-22 249	37-731-22 241
37-635-14 207	37-656-2018 233	37-703-16 249	37-736-16 253
37-635-18 207	37-670-20 217	37-703-22 249	37-736-22 253
37-635-24 207	37-670-22 217	37-710-222 271	37-737-16 253
37-638-22 199	37-670-24 217	37-710-222-EM . . 271	37-737-22 253
37-638-24 199	37-670-40 217	37-710-224 271	37-739-16 257
37-639-22 199	37-671-20 217	37-710-224-EM . . 271	37-739-22 257
37-639-24 199	37-671-22 217	37-711-222 271	37-740-16 263
37-640-22 199	37-671-24 217	37-711-222-EM . . 271	37-740-22 263
37-640-24 199	37-671-40 217	37-711-224 271	37-741-16 263
37-648-6 189	37-672-20 217	37-711-224-EM . . 271	37-741-22 263
37-649-6 189	37-672-22 217	37-712-222 259	37-742-16 263
37-650-14 193	37-672-24 217	37-712-222-EM . . 259	37-742-22 263
37-650-1314 193	37-672-40 217	37-712-224 259	37-750-16 265
37-650-2018 193	37-673-20 217	37-712-224-EM . . 259	37-750-22 265
37-651-14 195	37-673-22 217	37-713-222 259	37-752-16 269
37-651-1314 195	37-673-24 217	37-713-222-EM . . 259	37-752-22 269
37-651-2018 195	37-673-40 217	37-713-224 259	

2017-2018 ORDERING INFORMATION

phone: 877.607.0202

fax: 877.607.0203

email: customersupport@oxygenlighting.com

HOW TO ORDER

Orders are placed with authorized Oxygen sales representatives.

WAREHOUSE/ORDERING HOURS

Warehouse operations are open from 8:00am - 5:30pm Central Standard Time Monday through Friday.

PRICES

Buyer agrees to pay Company's established prices in effect on date of shipment if shipment is from other persons or firms, or on date of delivery if delivered from Company's stock. Prices are F.O.B. shipping point. Where transportation charges are expressly included, the same are based on present rates, and are subject to adjustment for any increase or decrease in effect at time of shipment. Any direct tax, including sales or use tax, imposed by law with respect to the sale or manufacture of any merchandise sold is to be added.

TERMS

All invoices are due and payable on a net 30-day basis from invoice date unless otherwise stated on the invoice. All past due invoices arising hereunder or otherwise owing to Company by Buyer shall bear interest at the maximum rate per annum provided by law, but in no event any rate in excess of that permitted by law.

CREDIT

All sales are subject to approval by the credit department of Company. If the credit rating of Buyer becomes unsatisfactory in the opinion of the credit department of Company prior to delivery of the merchandise covered by any order, the sale may be cancelled by Company. If Buyer fails to fulfill any terms of the purchase agreed upon in connection with this or any other order, Company may defer delivery until compliance therewith is made, or at its option may cancel any sale. For credit approval of new accounts, a completed and signed Company credit application must be in our possession before credit verification can begin. New accounts normally take 48 hours to process. Company uses the services of Dun & Bradstreet and other credit reporting companies for credit analysis. We report delinquent accounts to those companies. We fill orders only after credit approval. Active accounts will be credit determined the same day the order is received. Orders for past due accounts are not shipped until the account status is current.

DELIVERY

Company shall not be responsible for any delay or failure to make delivery which is occasioned by causes beyond its control, including but not restricted to fires, floods, strikes, labor disputes, accidents, embargoes, delays in transportation, fuel, material or labor shortages, failure to obtain delivery from manufacturers or subcontractors, any ruling, regulation or law of any government bureau or agency, or by any Act of God. Delays so caused shall not release Buyer from his obligation to accept and pay for goods. Company's responsibility ceases upon delivery of the merchandise to the carrier.

SHIPPING POINT FOR ALL PURPOSES

All shipments are FOB Company's warehouse, in Fort Worth, Tarrant County, Texas.

SHIPPING METHOD AND CHARGES

Company ships via the least expensive, not necessarily the fastest, carriers. If Buyer has a preferred carrier and wishes to pay the freight charges directly to the carrier, please provide your account number for the carrier of your choice. For basic ground transportation services, the Buyer may be asked to pay a premium for custom selected carriers. Buyer will be required to pay the entire Freight Services charge for any shipments using expedited ground transport or air transport services. For orders of \$300 or more: Freight charges for standard LTL commercial delivery or parcel delivery will be equal to 10% of the total order amount for shipments in the USA. For orders of less than \$300: Freight charges for standard LTL commercial delivery or parcel delivery will be equal to 30% of the total order amount for shipments in the USA. Any shipment outside of the USA, Buyer should contact Company's Customer Service Department for a freight quote. If any items are backordered, they will also be billed at the same freight rate as the original order, when they ship. If payment terms are Prepaid, freight charges for the entire order are billed with the initial shipment or release and back orders or future releases, if any, ship freight prepaid. Company contracts with LTL freight carriers for standard commercial delivery only. Residential deliveries or accessorial services from LTL carriers will incur additional charges that are in addition to the freight rates stated above. If you advise us that you need such services when you place your order, we will prepay for the services and add them to your invoice. Otherwise, the freight carrier will bill you directly for such additional services. Parcel shipments (such as UPS) will not incur additional freight charges for residential delivery or accessorial services.

SHORTAGE CLAIMS

Any claim for shortage must be made to Company within 3 days of delivery.

FREIGHT CLAIMS

We assure that products are in good condition prior to packing and shipping. Company is not responsible for shipments after they leave our warehouse. The carrier signs for acceptance at that time. Buyers must examine all arriving shipments for evidence of damage or breakage, and must refuse acceptance or file a claim with the carrier for compensation. UNDER NO

CIRCUMSTANCES SHALL OXYGEN BE RESPONSIBLE FOR DAMAGE IN U.P.S./FED EX SHIPMENTS. All shipments are FOB Company's warehouse in Fort Worth, Tarrant County, Texas.

RETURNED GOODS

Merchandise Returned for Credit must be accompanied by a returned merchandise authorization (RMA) number issued by Company within 90 days of our invoice date. Merchandise must be returned; freight prepaid, in its original factory sealed packaging and is subject to a 50% restocking fee. Discontinued, non-standard, modified (CDX) or unsaleable merchandise will not be accepted as returned goods for credit. Merchandise Returned Under Warranty for Credit must be accompanied by a return merchandise authorization (RMA) number issued by us within the warranty period. In addition, ceiling fan warranty claims made by Company dealers on behalf of end users must be accompanied by a copy of the end user's dated proof of purchase as evidence of warranty validity. Merchandise must be returned, freight prepaid, in its original factory packaging. Merchandise that has been modified, or is missing parts, or that is not in its original packaging will be repaired and returned freight prepaid (if the warranty claim is approved). If merchandise cannot be repaired, credit will be issued at the invoiced value, less the value of any missing parts.

CANCELLATION BY BUYER

No merchandise may be returned for credit or replacement except on written approval by Company. Orders placed with and accepted by Company may not be cancelled except with Company's written consent. Purchase orders cancelled more than 5 days after the date of Acknowledgement / Proforma are subject to a 50% cancellation fee.

DROP SHIPMENTS

Company reserves the right to refuse drop shipment or pick-up orders that are bound for destinations outside the Buyer's regular or assigned selling or service area. Drop shipments are subject to additional charges and at Company's discretion.

LIMITED WARRANTY

Company warrants that our products are free of defects in workmanship and materials. **Such warranty is in lieu of all other warranties including, without limitation, any implied warranties of merchantability or fitness for a particular purpose.** Company will, at our sole option, repair or replace, FOB shipping point, freight prepaid within the Continental U.S., any of our products defective in workmanship or materials. Such repair or replacement is the sole and exclusive remedy against Company and is limited to one (1) year from the date of invoice to the original end user of all lighting, ceiling fan and accessory products (except Energy Star lighting products). Company warrants our Energy Star lighting products for three (3) years from the date of the invoice to the original end user. The Company warrants our integral LED light fixtures for five (5) years from the date of invoice to the original end user on driver and array parts. The Company also offers specific warranty on its ceiling fans directly to the end users of such products and such warranties will vary between models. Consult the warranty inside each ceiling fan box for further information. The Company's warranties are not applicable to any lighting product that is not installed and operated in accordance with the National Electric Code (NEC) and Company's product instructions, including, but not limited to, lamping requirements and installation instructions. Consult the warranty included inside each light fixture box for further information. Company does not warrant any product which we promote and sell as "discontinued" or any product which has been altered or repaired outside of our factory or any product which, in our opinion, has been subject to abuse, misuse, negligence, accident or improper installation, maintenance or storage. **Company will not be responsible for any costs incurred in the removal or reinstallation of any product nor any consequential or incidental damages arising out of or in connection with product use or performance or any breach of aforementioned warranties.** The terms, specifications, and conditions contained herein supersede all previous terms, specifications, and conditions, and are subject to change without notice.

PLACE OF PAYMENT AND APPLICABLE LAW

Buyer agrees to pay all sums which may become due under this order or which he may otherwise owe to Company at the principal office of Company in Fort Worth, Tarrant County, Texas. This agreement shall be governed by and construed in accordance with the laws of the State of Texas. Buyer hereby agrees and consents to the jurisdiction of the Courts of the State of Texas and further consents to the exclusive and mandatory venue in Tarrant County, Texas, for any dispute arising between the Company and Buyer.

FORBEARANCE/NO WAIVER

Forbearance or failure of Company to enforce any of these conditions or to exercise any right accruing from any default of Buyer shall not affect or impair Company's rights should such default continue or in case of any subsequent default of Buyer, nor shall such forbearance or failure be deemed a waiver of Company's rights in case of other or future defaults of Buyer.

SECURITY INTEREST

Buyer grants Company a security interest in all goods purchased from Company, the exact description of which goods is found in each invoice presented to Buyer. Buyer appoints Company, as Buyer's attorney-in-fact for purposes of signing and filing with appropriate authority a Financing Statement (UCC-1) or any modification or extension thereof.

CATBIGX18

Oxygen Rev. 3-1-18



oxygen

LIGHTING & FANS

2018 | 2019