

# OXYGEN

2019 / 20 LIGHTING & FANS













oxygen





# TABLE OF CONTENTS

	16	Ceiling Fans
	34	Sconces
	112	Vanities
	160	Ceiling Mounts
	196	Pendants
	232	Outdoor
	262	Accessories, Diffusers & Finishes
	268	Index

# SPECIFIER INSTRUCTIONS

## THE PRODUCT DIAGRAM

indicates how the measurements of the fixture are determined and contains an approximate "human-scale" drawing of the fixture.

## THE SPEC CHART

for each fixture indicates which diffusers are available with each finish as well as lamping information and dimensions. If there are options available they will be indicated along with a sample product number to aid in specifying the options. Specs may be highlighted to help distinguish differences between similar looking products.

## GENERAL SPECIFICATIONS

such as housing, trim, diffuser thicknesses and how to obtain additional information from Oxygen.

## DEFINITIONS/HOW-TO'S

ITEM # - fixture model number

PREFIX NOTES:

**2-597-XXX** = fluorescent model (or incandescent)

**3-587-XXX** = 120V LED or 120/277 UV LED model

**32-XXX-XXX** = 120/277 UV LED model

MODEL SERIES:

2-**597-XXX** - **597** = Beacon fluorescent series

3-**587-XXX** - **587** = Beacon LED series

DIFFUSER/FINISH:

2-597-**124** = White Cotton (**1**) w/ Satin Nickel (**24**) finish

3-587-**295** = Matte White Acrylic (**2**) w/ Old World (**95**) finish

DIFFUSER - type of diffuser or options available for model.

FINISH - finish/ finishes available for model.

DIMENSIONS - fixture dimensions as indicated in product diagram illustration.



LAMPING - lamp type (incandescent, fluorescent or LED), wattage and other pertinent information for lamp specified.

BALLAST - ballast specifications for fluorescent models.

DRIVER - driver specifications for LED models.

CERTIFICATION - compliance standards mark for fixture model. Also indicates damp/ wet listings, ADA compliance, emergency ballast and energy star items.

## SAMPLE SPECIFICATION CHART

ITEM #	DIFFUSER	FINISH	DIMENSIONS	LAMPING	DRIVER	CERTIFICATION
<b>3-5010-XX</b>	Matte White Acrylic	<b>15</b> Black <b>20</b> Polished Nickel <b>24</b> Satin Nickel <b>40</b> Aged Brass	4.5"(w) x 12.125"(h) x 3.125"(ext)	1 x 9w, 90CRI 3000k LED	120V Triac dimming	  

## GENERAL SPECIFICATIONS:

• Cold rolled steel backplate and trim. • Acrylic shade is 1/8", matte white finish. • Unit mounts to deep 4" octagonal junction box or deep 4"x4" square junction box w/ single device mud ring. • Unit requires 2.5" deep junction box. • Driver mounts inside junction box. • Total luminaire power 11.3w. • Visit [www.oxygenlighting.com](http://www.oxygenlighting.com) for technical cut sheets. • Oxygen reserves the right to modify designs at any time.

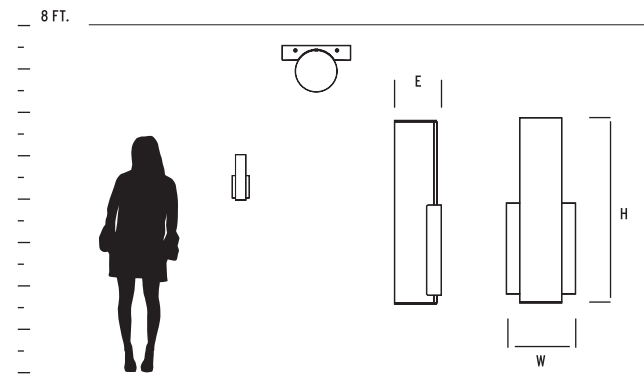

## SYMBOLS

 - UL listed for damp locations

 - UL listed for wet locations

 - ETL listed for damp locations

 - ETL listed for wet locations

 - ADA compliant

 - integral battery backup option

 - UL listed

 - ETL listed



**FAN PERFORMANCE BY ROOM**

ROOM SIZE	SQUARE FEET	ROOM TYPE	FAN SWEEP	CUBIC FEET/MINUTE (CFM)
<b>small</b>	80 sq. ft or less	utility room, bathroom, closet	20" - 28"	1500 - 3500
<b>medium</b>	90-120 sq. ft or less	small bedroom, office, bathroom	38" - 52"	3500 - 5000
<b>large</b>	125-300 sq. ft	kitchen, bedroom, dining room, living room	52" - 56"	5000 - 8000
<b>great</b>	350-400 sq. ft	great room, master suite, outdoor	56" - 99"	7000 - 15000

### FLUSH MOUNT/HUGGER FANS

This type of mount is recommended for 8' ceilings. The National Electric Code requires that all fan blades be a minimum of 7' above the floor.

### DOWNROD OPTIONS FOR FANS

For 9' ceilings, a downrod from 4"-8" is installed between the ceiling canopy and the fan. Installing the fan further away from the ceiling allows for more air circulation and fan efficiency. All oxygen fans, with exception of huggers, come with a standard downrod for this application. **For ceilings 10' and above, oxygen offers additional length downrods found on page 266.**

## SPECIFIER INSTRUCTIONS

### THE PRODUCT DIAGRAM

indicates how the measurements of the fixture are determined and contains an approximate "human-scale" drawing of the fixture.

### THE SPEC CHART

for each fan indicates available finishes, blades and options. If there are light kit options available they will be indicated along with a product number to aid in specifying the options. Wall and remote controls will be indicated as well as if they are included or optional.

### HEIGHT CHART & FAN HEIGHT

shows the distance from the ceiling to the fan blades and motor.

### GENERAL SPECIFICATIONS

will list motor warranty, number of blades, blade sweep and pitch and downrod information.

### MECHANICAL SPECIFICATIONS

lists motor type, available options and mechanical performance.

### ENERGY SPECIFICATIONS

airflow and energy used on high speed.

### DOE ENERGY GUIDE INFORMATION

quick reference of energy specifications.

### SAMPLE SPECIFICATION CHART

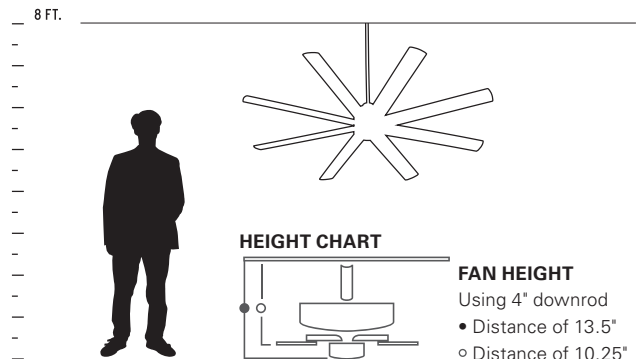

ITEM #	FINISH	BLADES	LED LIGHT KIT (optional)	CONTROLS	CERTIFICATION
3-100-XX	6 White 15 Black* 20 Polished Nickel 22 Oiled Bronze 24 Satin Nickel	White Black ABS Silver Oiled Bronze Silver	 <b>3-9-100</b> 18w, 3000k, 90CRI Dimmable LED, 1247 Delivered Lumens w/ Matte White Glass Diffuser	 Wall Control (included)  <b>3-8-2000-0</b> Remote Control (optional)	

#### GENERAL SPECIFICATIONS:

• Lifetime Motor Warranty • Eight Blades • 70° Blade Sweep • 14-Degree Blade Pitch • 80" Lead Wire • 4" and 6" Downrod (Included) • Additional Downrod options on page 266.

#### MECHANICAL SPECIFICATIONS:

• 165mm DC Motor. • 6 Speeds-Reversible with wall control. • 8 Poles. • .47/.06 AMPS on H/L • 35/3 WATTS on H/L • 114/49 RPMs on H/L. • Wall Control Included.  
• Remote Control Adaptable w/ 3-8-2000-0 Remote

#### ENERGY SPECIFICATIONS:

• Energy Information at High Speed. • Airflow: 9448 Cubic Feet/Minute. • Electricity Use: 35 Watts (Excludes Lights). • Airflow Efficiency: 269 Cubic Feet/Minute/Watt.

#### DOE ENERGY GUIDE INFORMATION

• Airflow 6832 cfm. • Watts 22. • Airflow efficiency 306 cfm/w. • Estimated yearly energy cost \$6.

# CEILING FANS



**ALPHA 18**



**CODA 20**



**COSMO 22**



**OLSO 24**



**OSLO HUGGER 26**



**PROPEL 28**



**SOL 30**



**SOLIS 32**

# SCONCES

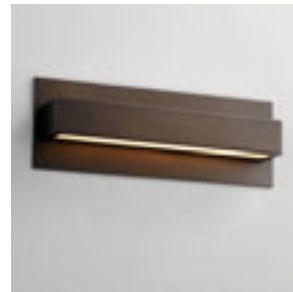

**ALCOR 36**  
ADA | LED



**APOLLO 38**  
ADA | LED



**AURORA 40**  
ADA | LED



**BEACON 42**  
ADA | LED



**BOLO 44**  
ADA | LED



**CHAMELEON 46**  
ADA | LED





**CRESCENT 50**  
ADA | LED



**DUO 52**  
ADA | LED

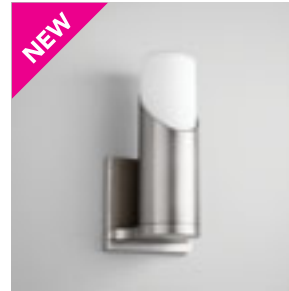

**ELLIPSE 54**  
ADA | LED

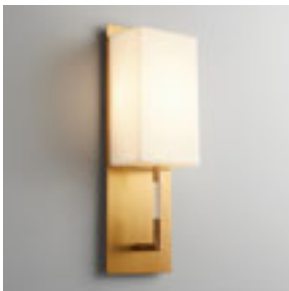

**EPOCH 56**  
ADA | LED



**FUGIT 58**  
ADA | LED

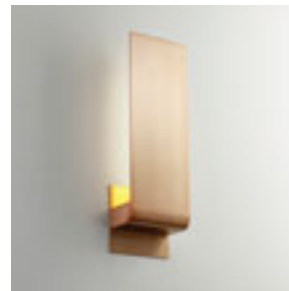

**HALO 60**  
ADA | LED



**ICON 62**  
ADA | LED



**KIKO 64**  
ADA | LED



**MAGNETA 66**  
ADA | LED



**MAGNUM 68**  
ADA | LED



**METRIX 70**  
ADA | LED

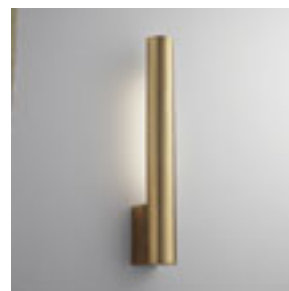

**MIES 72**  
ADA | LED



**MIRAGE 74**  
ADA | LED



**OLIO 76**  
ADA | LED

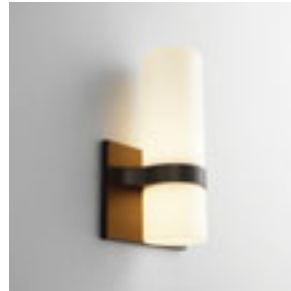

**OLIO 78**  
ADA | LED

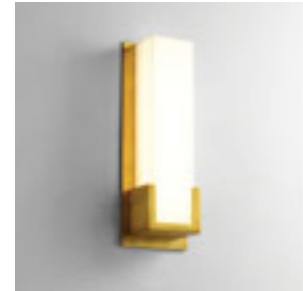

**ORION 80**  
ADA | LED



**PATHWAYS 82**  
ADA | LED | EM

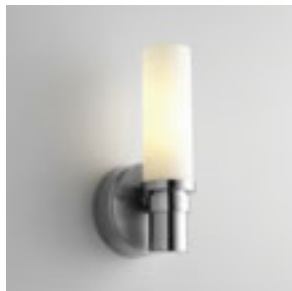

**PEBBLE 84**



**POLARIS 86**  
ADA | LED | EM



**PROFILE 88**  
ADA | LED



**REFLEX 90**  
ADA | LED

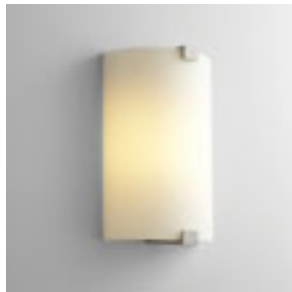

**SIREN 92**  
ADA | LED

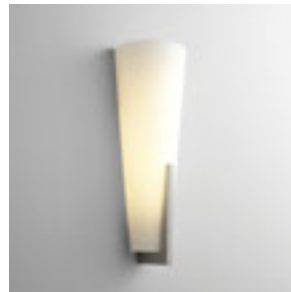

**SONGBIRD 94**  
ADA | LED



**TEMPUS 96**  
ADA | LED



**UNO 98**  
ADA | LED



**VEGA 100**  
ADA | LED

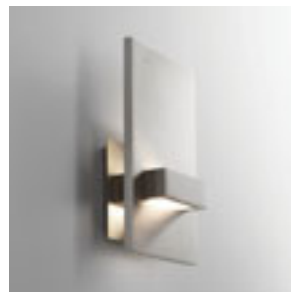

**VELA 102**  
ADA | LED



**WAVE 104**  
ADA | LED



**ZEEPERS 106**  
ADA | LED



**ZETA 110**  
ADA | LED

VANITIES



**ADAGIO 114**  
ADA | LED



**ADELPHI 116**  
ADA | LED



**ALCOR 118**  
ADA | LED



**APOLLO 120**  
ADA | LED



**ARCHER 124**  
ADA | LED



**AXEL 126**  
ADA | LED



**BALANCE 128**  
ADA | LED



**CRESCENT 130**  
ADA | LED



**FUGIT 132**  
ADA | LED



**FUSE 134**  
ADA | LED



**HORIZON 136**  
LED



**MAGNETA 138**  
ADA | LED



**MAGNUM 140**  
ADA | LED



**METRIX 142**  
ADA | LED



**ORION 144**  
ADA | LED

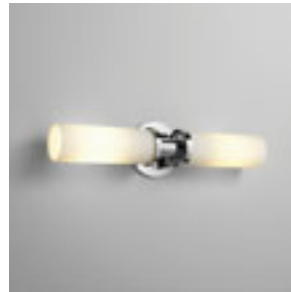

**PEBBLE 146**  
ADA



**PLATO 148**  
ADA | LED



**SKYLINE 150**  
ADA



**TEMPUS 152**  
ADA | LED



**VEGA 154**  
ADA | LED



**WAVE 156**  
ADA | LED



**ZENITH II 152**  
ADA | LED

## CEILING MOUNTS



**AURORA 162**  
ADA | LED



**DIONE 164**  
ADA | LED | EM



**ECHO 166**  
LED | EM

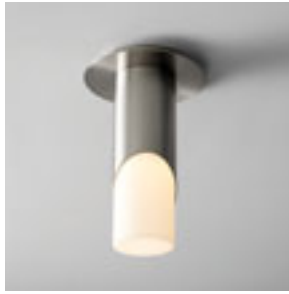

**ELLIPSE 168**  
LED



**iO 170**  
LED | EM



**JOURNEY 172**  
LED | EM



**MODULO 176**  
LED | EM



**ORACLE 178**  
ADA | LED | EM



**PEEPERS 182**  
ADA | LED | EM

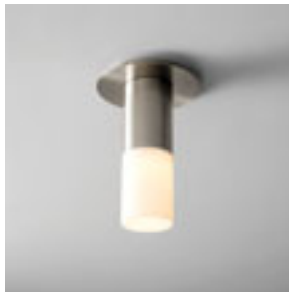

**PILAR 186**  
LED

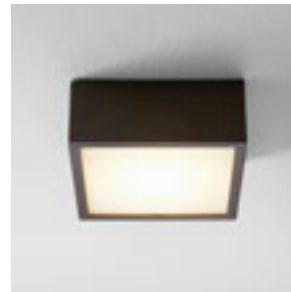

**PYXIS 188**  
ADA | LED



**RHYTHM 192**  
ADA | LED



**ZURI 194**  
ADA | LED

PENDANTS



**CORNET 198**  
LED



**ECHO 200**  
LED



**ELLIPSE 202**  
LED



**GALAXY 204**  
LED



**GRATIS 206**  
LED



**IDOL 208**  
LED



**KLONE 210**  
LED



**LIBERTY 212**  
LED



**LOTUS 214**



**LUNA 216**  
LED

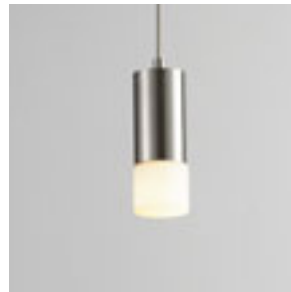

**MAGNETA 218**  
LED

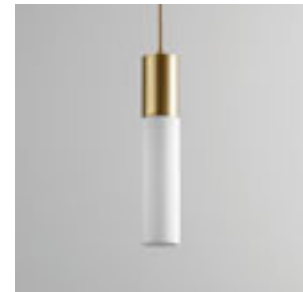

**MAGNUM 220**  
LED



**OPUS 222**  
LED



**RUVO 224**  
LED



**SPINDLE 226**  
LED

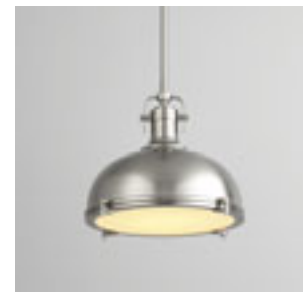

**VIDA 228**  
LED



OUTDOOR



**ZEPP 230**  
LED



**CALYPSO 234**  
ADA | LED

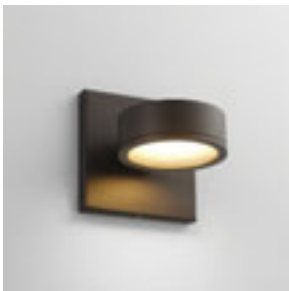

**CERES 236**  
LED



**DUO 238**  
ADA | LED

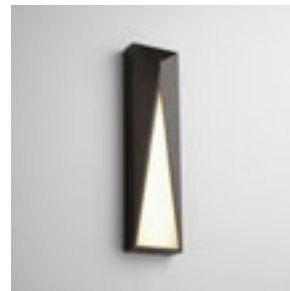

**ELIF 240**  
ADA | LED



**ERIS 242**  
ADA | LED



**KARME 244**  
ADA | LED



**LEDA 246**  
LED | EM



**MAGNETA 248**  
ADA | LED



**MAIA 250**  
ADA | LED



**REALM 252**  
LED



**REGIO 254**  
ADA | LED



**SCOPE 256**  
LED



**TELHOR 258**  
LED | EM



**UNO 260**  
ADA | LED







# CEILING FANS





# ALPHA 60" CEILING FAN

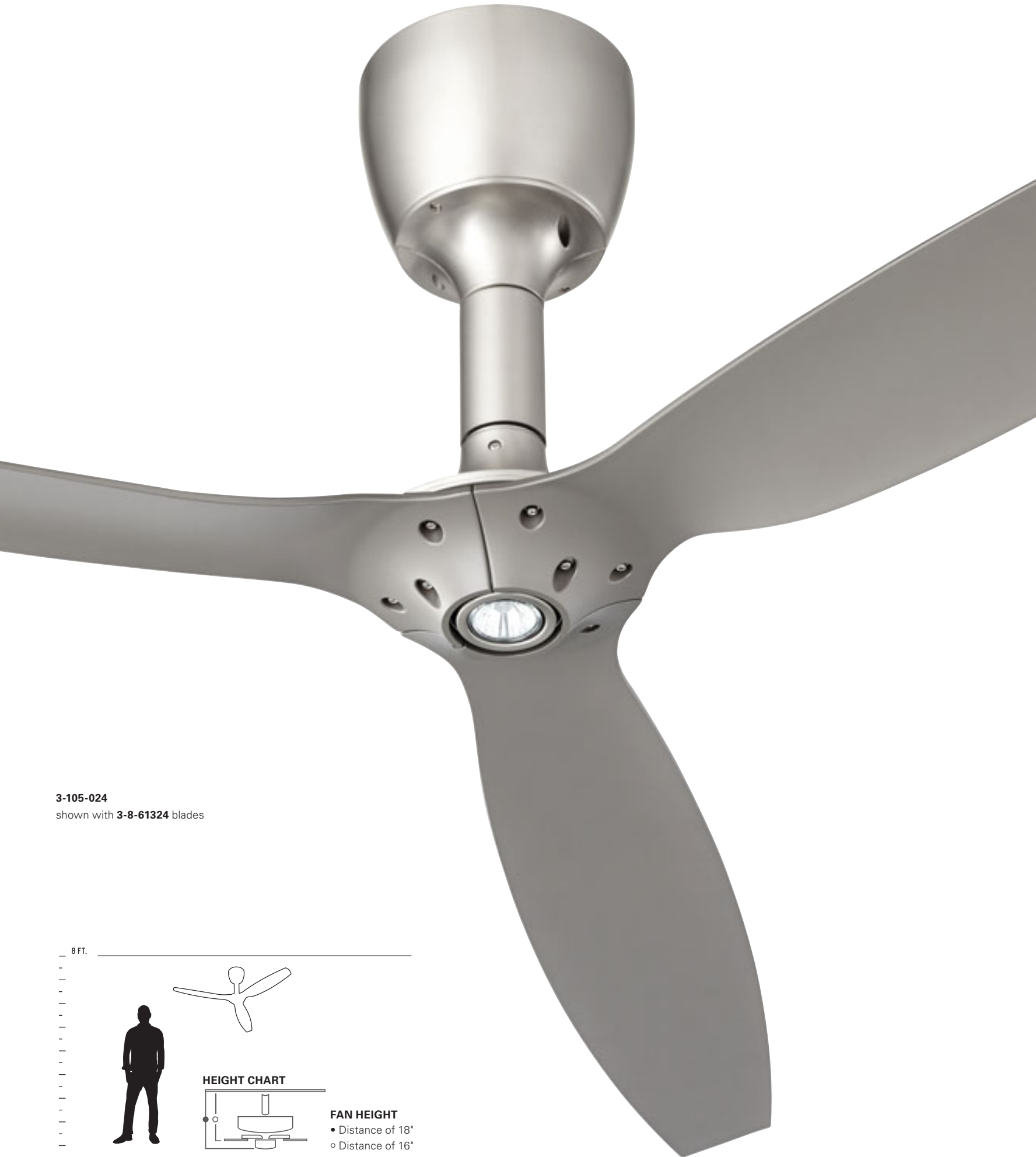



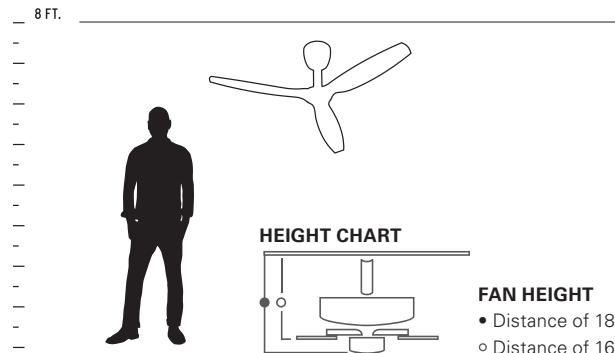

**3-105-024**

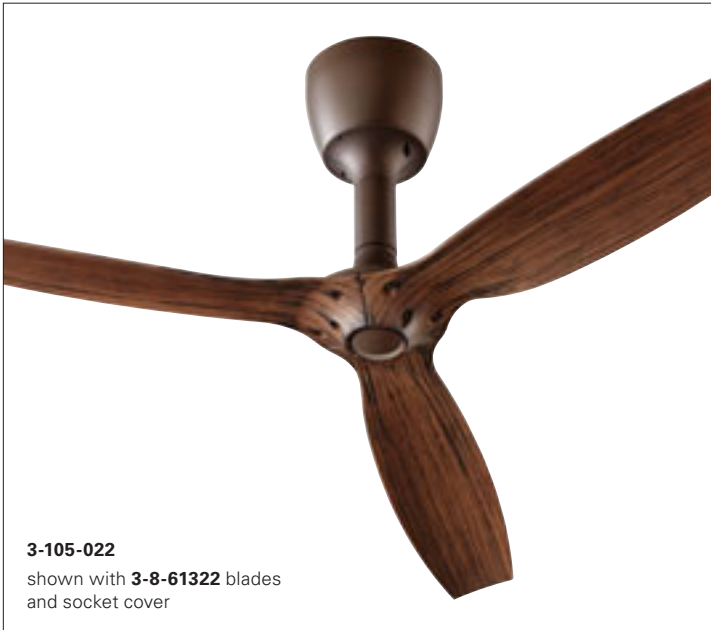
shown with **3-8-61324** blades





ITEM #	FINISH	BLADE SELECTION	OPTIONAL LED LAMP (included)		CONTROLS		CERTIFICATION
<b>3-105-0XX</b>	6 White 22 Oiled Bronze 24 Satin Nickel	<b>3-8-61306</b> White <b>3-8-61322</b> Walnut <b>3-8-61324</b> Silver		7w, 2700k, 80CRI, Dimmable LED GU10 Bulb  (Finished Socket Cover Included for use w/o Optional LED Lamp)	 Wall Control (included)	 <b>3-8-2000-0</b> Remote Control (optional)	

## HOW TO ORDER THE ALPHA FAN:

### A. First Pick the Housing/Motor Finish from below:

- 3-105-06** White
- 3-105-022** Oiled Bronze
- 3-105-024** Satin Nickel

### B. Then Choose the Blade Finish from below:

- 3-8-61306** White
- 3-8-61322** Walnut
- 3-8-61324** Silver

\*Note - Housing/Motor and Blades options will ship separately.

### GENERAL SPECIFICATIONS:

- Lifetime Motor Warranty. • Three Blades. • 60" Blade Sweep. • 18-Degree Blade Pitch. • 58" Lead Wire.

### MECHANICAL SPECIFICATIONS:

- 125mm DC Motor. • 6 Speeds-Reversible with wall control. • 12 Poles. • .44/.07 AMPS on H/L • 32/3 WATTS on H/L • 133/50 RPMS on H/L. • Wall Control Included. • Finished socket cover included.

### ENERGY SPECIFICATIONS:

- Energy Information at High Speed. • Airflow: 8200 Cubic Feet/Minute. • Electricity Use: 32 Watts (Excludes Lights). • Airflow Efficiency: 256 Cubic Feet/Minute/Watt.

### DOE ENERGY GUIDE INFORMATION

- Airflow 5773 cfm. • Watts 22. • Airflow efficiency 267 cfm/w. • Estimated yearly energy cost \$6.

# CODA 56" CEILING FAN



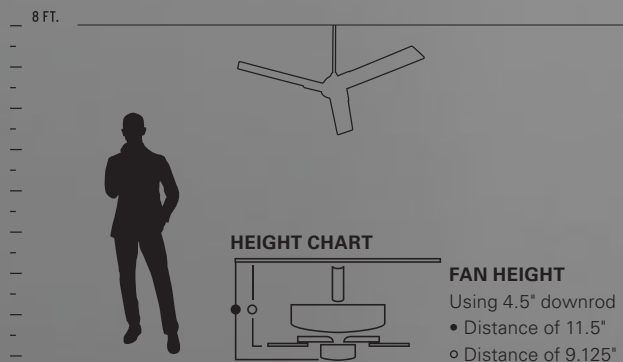

3-103-24  
shown with optional light kit 3-9-102





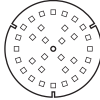

ITEM #	FINISH	BLADES	LED LIGHT KIT (optional)	CONTROLS	CERTIFICATION
<b>3-103-XX</b>	6 White 15 Black 20 Polished Nickel 22 Oiled Bronze 24 Satin Nickel	White Black Silver Oiled Bronze Silver	 <p><b>3-9-102</b> 15w, 3000k, 90CRI Dimmable LED, 743 Delivered Lumens w/ Matte White Polycarbonate Diffuser</p>	 <p>Wall Control (included)</p> <p><b>3-8-3000</b> Remote Control (optional)</p>	

**GENERAL SPECIFICATIONS:**

- Lifetime Motor Warranty. • Three Blades. • 56" Blade Sweep. • 13.5-Degree Blade Pitch. • 80" Lead Wire. • 4.5" Downrod (Included) • Additional Downrod options on page 266.

**MECHANICAL SPECIFICATIONS:**

- 120mm DC Motor. • 6 Speeds-Reversible with wall control. • 8 Poles. • .43/.07 AMPS on H/L • 28/3 WATTS on H/L • 166/72 RPMS on H/L. • Wall Control Included.

**ENERGY SPECIFICATIONS:**

- Energy Information at High Speed. • Airflow: 5238 Cubic Feet/Minute. • Electricity Use: 28 Watts (Excludes Lights). • Airflow Efficiency: 187 Cubic Feet/Minute/Watt.

**DOE ENERGY GUIDE INFORMATION**

- Airflow 3815 cfm. • Watts 18. • Airflow efficiency 208 cfm/w. • Estimated yearly energy cost \$5.

# COSMO 70" CEILING FAN



**3-100-15\***  
shown with optional light kit **3-9-100** and  
black ABS blades **3-662-24**  
\*damp listed

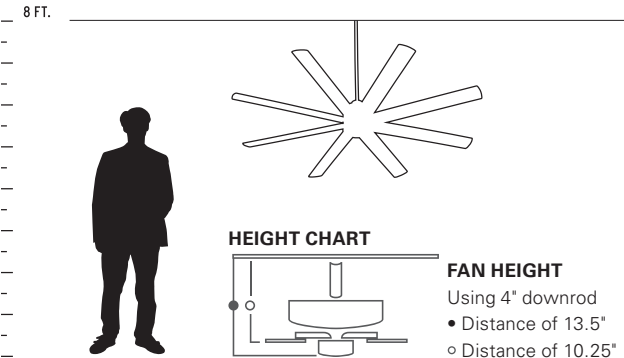



ITEM #	FINISH	BLADES	LED LIGHT KIT (optional)	CONTROLS	CERTIFICATION
<b>3-100-XX</b>	6 White 15 Black* 20 Polished Nickel 22 Oiled Bronze 24 Satin Nickel	White Black ABS Silver Oiled Bronze Silver	 <p><b>3-9-100</b> 18w, 3000k, 90CRI Dimmable LED, 1247 Delivered Lumens w/ Matte White Glass Diffuser</p>	 <p>Wall Control (included)</p>  <p><b>3-8-2000-0</b> Remote Control (optional)</p>	

**GENERAL SPECIFICATIONS:**

- Lifetime Motor Warranty • Eight Blades • 70" Blade Sweep • 14-Degree Blade Pitch • 80" Lead Wire • 4" and 6" Downrod (Included) • Additional Downrod options on page 266.

**MECHANICAL SPECIFICATIONS:**

- 165mm DC Motor. • 6 Speeds-Reversible with wall control. • 8 Poles. • .47/.06 AMPS on H/L • 35/3 WATTS on H/L • 114/49 RPMS on H/L. • Wall Control Included.
- Remote Control Adaptable w/ 3-8-2000-0 Remote

**ENERGY SPECIFICATIONS:**

- Energy Information at High Speed. • Airflow: 9448 Cubic Feet/Minute. • Electricity Use: 35 Watts (Excludes Lights). • Airflow Efficiency: 269 Cubic Feet/Minute/Watt.

**DOE ENERGY GUIDE INFORMATION**

- Airflow 6832 cfm. • Watts 22. • Airflow efficiency 306 cfm/w. • Estimated yearly energy cost \$6.





# OSLO 52" CEILING FAN

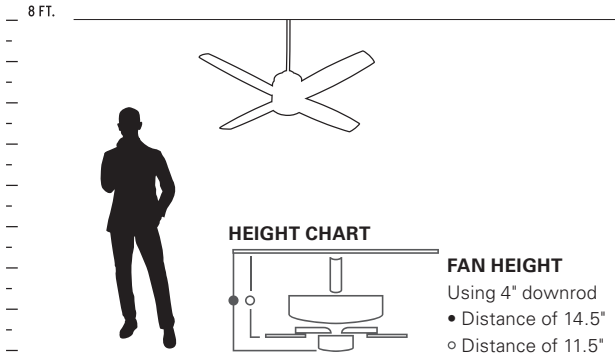

**3-101-15\***  
shown with optional light kit **3-9-101**  
and black ABS blades  
\*damp listed

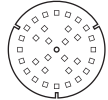



ITEM #	FINISH	BLADES	LED LIGHT KIT (optional)	CONTROLS	CERTIFICATION
<b>3-101-XX</b>	6 White 15 Black* 20 Polished Nickel 22 Oiled Bronze 24 Satin Nickel	White Black ABS Silver Oiled Bronze Silver	 <b>3-9-101</b> 18w, 3000k, 90CRI, Dimmable LED, 1274 Delivered Lumens w/ Matte White Glass Diffuser	 Wall Control (included)  Remote Control <b>3-8-1000-0*</b> (optional)	

\*3-8-1000-0 remote features 3 fan speeds, forward/reverse function, light kit on/off/dimmer and timer that will turn off the fan after 2, 4 or 8 hours.

**GENERAL SPECIFICATIONS:**

• Lifetime Motor Warranty. • Four Blades. • 52" Blade Sweep. • 14-Degree Blade Pitch. • 80" Lead Wire. • 4" & 6" Downrods (Included) • Additional Downrod options on page 266.

**MECHANICAL SPECIFICATIONS:**

• 153x18 Motor. • 3 Speeds-Reversible with wall control. • 14 Poles. • .54/.28 AMPS on H/L • 64/16 WATTS on H/L • 147/72 RPMS on H/L. • Wall Control Included. • Remote Control Adaptable w/ 3-8-1000-0 Remote.

**ENERGY SPECIFICATIONS:**

• Energy Information at High Speed. • Airflow: 4991 Cubic Feet/Minute. • Electricity Use: 64 Watts (Excludes Lights). • Airflow Efficiency: 78 Cubic Feet/Minute/Watt.

**DOE ENERGY GUIDE INFORMATION**

• Airflow 3770 cfm. • Watts 43. • Airflow efficiency 88 cfm/w. • Estimated yearly energy cost \$12.

# OSLO HUGGER 52" CEILING FAN





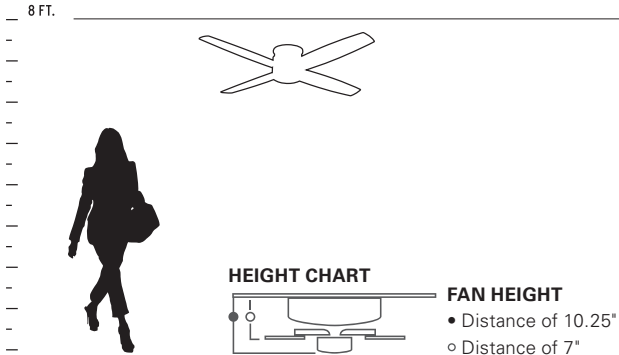

**3-102-15\***  
shown with optional light kit **3-9-101**  
and black ABS blades  
\*damp listed



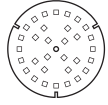



ITEM #	FINISH	BLADES	LED LIGHT KIT (optional)	CONTROLS	CERTIFICATION
<b>3-102-XX</b>	6 White 15 Black* 20 Polished Nickel 22 Oiled Bronze 24 Satin Nickel	White Black ABS Silver Oiled Bronze Silver	 <b>3-9-101</b> 17w, 3000k, 90CRI, Dimmable LED, 1274 Delivered Lumens w/ Matte White Glass Diffuser	 Wall Control (included)  Remote Control <b>3-8-1000-0*</b> (optional)	

\*3-8-1000-0 remote features 3 fan speeds, forward/reverse function, light kit on/off/dimmer and timer that will turn off the fan after 2, 4 or 8 hours.

**GENERAL SPECIFICATIONS:**

- Lifetime Motor Warranty. • Four Blades. • 52" Blade Sweep. • 14-Degree Blade Pitch. • 22" Lead Wire.

**MECHANICAL SPECIFICATIONS:**

- 153x18 Motor. • 3 Speeds-Reversible with wall control. • 14 Poles. • .54/.28 AMPS on H/L • 64/16 WATTS on H/L • 153/74 RPMS on H/L. • Wall Control Included.
- Remote Control Adaptable w/ 3-8-1000-0 Remote.

**ENERGY SPECIFICATIONS:**

- Energy Information at High Speed. • Airflow: 3664 Cubic Feet/Minute. • Electricity Use: 64 Watts (Excludes Lights). • Airflow Efficiency: 57 Cubic Feet/Minute/Watt.

**DOE ENERGY GUIDE INFORMATION**

- Airflow 2764 cfm. • Watts 43. • Airflow efficiency 65 cfm/w. • Estimated yearly energy cost \$12.

# PROPEL 56" CEILING FAN



3-106-22

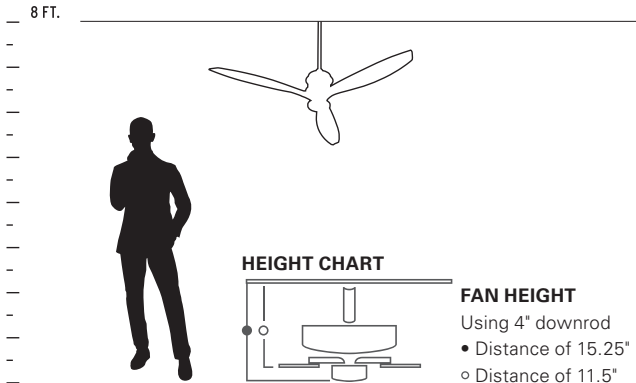







**3-106-6**

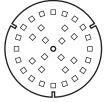

**3-106-24**

ITEM #	FINISH	BLADES	LED LIGHT KIT (included)	CONTROLS	CERTIFICATION
<b>3-106-XX</b>	6 White 22 Oiled Bronze 24 Satin Nickel	White Oiled Bronze Silver	 15w, 3000k, 90CRI, Dimmable LED w/White Glass Diffuser	 Wall Control (included)  <b>3-8-3000</b> Remote Control (optional)	

**GENERAL SPECIFICATIONS:**

- Lifetime Motor Warranty. • Three Blades. • 56" Blade Sweep. • 16-Degree Blade Pitch. • 80" Lead Wire. • 4.5" Downrod (Included) • Additional Downrod options on page 266.

**MECHANICAL SPECIFICATIONS:**

- 120mm DC Motor. • 6 Speeds-Reversible with wall control. • 8 Poles. • .42/.08 AMPS on H/L • 25/3 WATTS on H/L. • 191/75 RPMS on H/L. • Wall Control Included.

**ENERGY SPECIFICATIONS:**

- Energy Information at High Speed. • Airflow: 5116 Cubic Feet/Minute. • Electricity Use: 25 Watts (Excludes Lights). • Airflow Efficiency: 204 Cubic Feet/Minute/Watt.

**DOE ENERGY GUIDE INFORMATION**

- Airflow 3710 cfm. • Watts 18. • Airflow efficiency 211 cfm/w. • Estimated yearly energy cost \$5.

# SOL 52" CEILING FAN





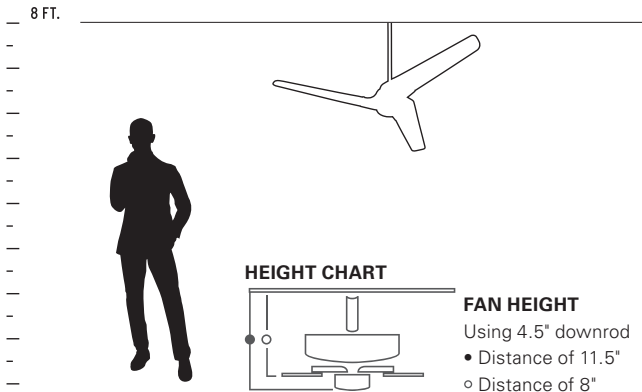

3-104-15\*  
\*damp listed

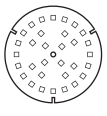

**HEIGHT CHART**

**FAN HEIGHT**  
Using 4.5" downrod  
• Distance of 11.5"  
◦ Distance of 8"



ITEM #	FINISH	BLADES	LED LIGHT KIT (optional)	CONTROLS	CERTIFICATION
<b>3-104-XX</b>	6 White 15 Black 20 Polished Nickel 22 Oiled Bronze 24 Satin Nickel	White Black Silver Oiled Bronze Silver	 <p><b>3-9-102</b> 15w, 3000k, 90CRI, Dimmable LED, 743 Delivered Lumens w/ Matte White Polycarbonate Diffuser</p>	 <p>Wall Control (included)</p>  <p><b>3-8-3000</b> Remote Control (optional)</p>	

**GENERAL SPECIFICATIONS:**

- Lifetime Motor Warranty. • Three Blades. • 52" Blade Sweep. • 15-Degree Blade Pitch. • 80" Lead Wire. • 4.5" Downrod (Included) • Additional Downrod options on page 266.

**MECHANICAL SPECIFICATIONS:**

- 120mm DC Motor. • 6 Speeds-Reversible with wall control. • 8 Poles. • .39/.07 AMPS on H/L • 23/3 WATTS on H/L. • 168/69 RPMS on H/L. • Wall Control Included.

**ENERGY SPECIFICATIONS:**

- Energy Information at High Speed. • Airflow: 4644 Cubic Feet/Minute. • Electricity Use: 23 Watts (Excludes Lights). • Airflow Efficiency: 202 Cubic Feet/Minute/Watt.

**DOE ENERGY GUIDE INFORMATION**

- Airflow 3272 cfm. • Watts 16. • Airflow efficiency 203 cfm/w. • Estimated yearly energy cost \$5.



# SOLIS 56" CEILING FAN

WET LISTED





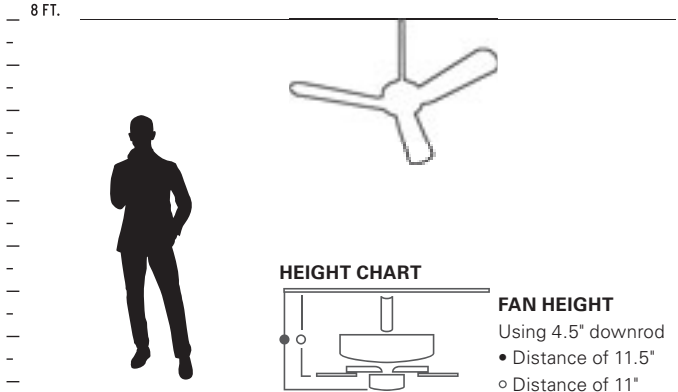

3-107-15



**HEIGHT CHART**

**FAN HEIGHT**  
Using 4.5" downrod  
• Distance of 11.5"  
◦ Distance of 11"



ITEM #	FINISH	BLADES	CONTROLS	CERTIFICATION	
<b>3-107-XX</b>	6 White 15 Black 24 Satin Nickel	White ABS Black ABS Silver ABS	 Wall Control (included)	 <b>3-8-1000-0</b> Remote Control (optional)	 

**GENERAL SPECIFICATIONS:**

- Lifetime Motor Warranty. • Three Blades. • 56" Blade Sweep. • 16-Degree Blade Pitch. • 80" Lead Wire. • 4" & 6" Downrods (Included) • Not Light Kit Adaptable. • Additional Downrod options on page 266.

**MECHANICAL SPECIFICATIONS:**

- 188x18 Motor. • 4 Speeds-Reversible with manual reverse switch. • 16 Poles. • .43/17 AMPS on H/L • 52/8 WATTS on H/L. • 157/58 RPMS on H/L. • Wall Control Included.

**ENERGY SPECIFICATIONS:**

- Energy Information at High Speed. • Airflow: 6192 Cubic Feet/Minute. • Electricity Use: 51 Watts (Excludes Lights). • Airflow Efficiency: 121 Cubic Feet/Minute/Watt.

**DOE ENERGY GUIDE INFORMATION**

- Airflow 4340 cfm. • Watts 31. • Airflow efficiency 138 cfm/w. • Estimated yearly energy cost \$9.

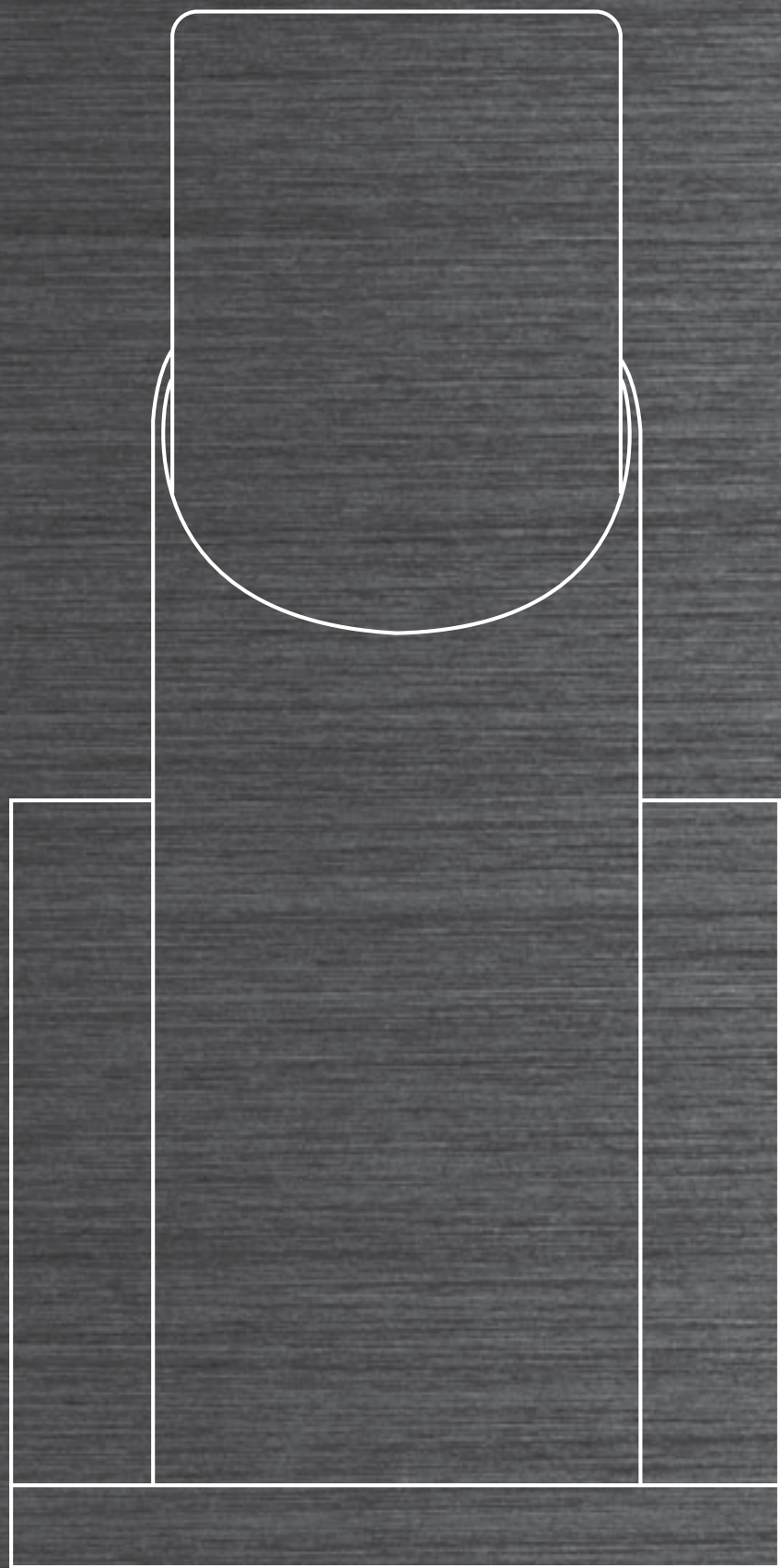



# SCONCES





# ALCOR SCONCE

ADA

LED



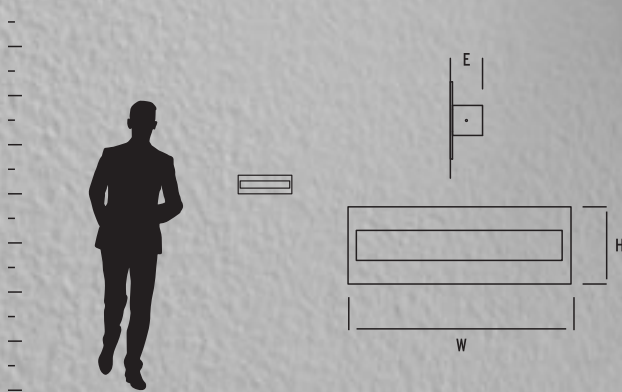

3-532-40

8 FT.







ITEM #	DIFFUSER	FINISH	DIMENSIONS	LAMPING	DRIVER	CERTIFICATION
3-532-XX	Matte White Acrylic	22 Oiled Bronze 24 Satin Nickel 40 Aged Brass	13"(w) x 4.5"(h) x 2"(ext)	1 x 11.9w, 90CRI 3000k LED	120/277V 0-10V/Phase dimming	  

2700k, 3500k, 4000k color temperatures also available. Visit [oxygenlighting.com](http://oxygenlighting.com)

**GENERAL SPECIFICATIONS:**

- Cold rolled steel backplate and trim. • Acrylic shade is 1/8", matte white finish. • Unit mounts to deep 4"x4" junction box or a deep 4"x4" junction box w/ single device mud ring. • Approved for wall mount applications only. • Driver mounts inside junction box. • Total luminaire power 15.2w. • Visit [www.oxygenlighting.com](http://www.oxygenlighting.com) for technical cut sheets.
- Oxygen reserves the right to modify designs at any time.

# APOLLO SCONCE

ADA

LED

FLOURESCENT







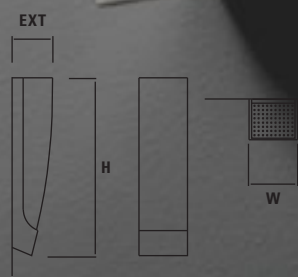

2-5107-24

8 FT.





3-570-24

ITEM #	DIFFUSER	FINISH	DIMENSIONS	LAMPING	BALLAST	DRIVER	CERTIFICATION
2-5107-24	Matte White Acrylic	24 Satin Nickel	4.5"(w) x 16"(h) x 3.75"(ext)	1 x 24w twin 4-pin fluorescent (2G11)	Electronic, HPF, Programmed Start, Universal Voltage (120-277V)	-	  
3-570-24	Matte White Acrylic	24 Satin Nickel	4.5"(w) x 16"(h) x 3.75"(ext)	1 x 10.1w, 90CRI 3000k LED	-	120/277V 0-10V/Phase dimming	  

2700k, 3500k, 4000k color temperatures also available for LED models. Visit [oxygenlighting.com](http://oxygenlighting.com)

**GENERAL SPECIFICATIONS:**

- Cold-rolled steel housing. • Perforated metal top lens. • Diffuser is 1/8" thick matte white acrylic. • Unit mounts to 4" octagonal junction box. • Toolless access to lamps for 2-5107-24.
- Approved for wall mount application only. • Total luminaire power 13.1w for LED models. • Visit [www.oxygenlighting.com](http://www.oxygenlighting.com) for technical cut sheets. • Oxygen reserves the right to modify designs at any time.

# AURORA SCONCE

ADA

LED



3-551-15

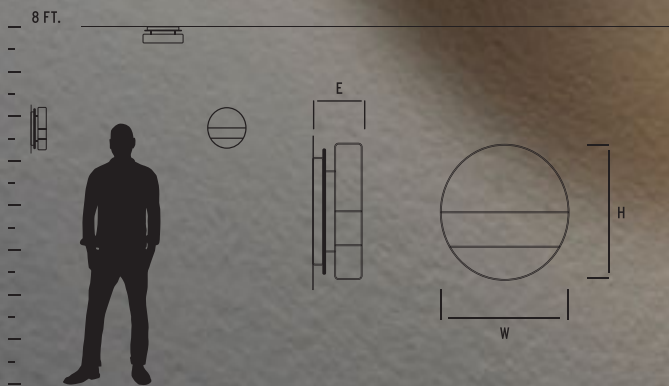

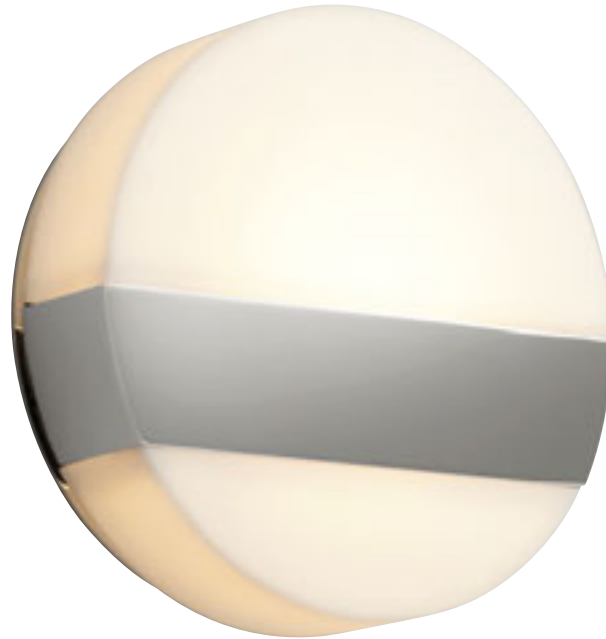



3-551-20



3-551-24

ITEM #	DIFFUSER	FINISH	DIMENSIONS	LAMPING	DRIVER	CERTIFICATION
3-551-XX	Matte White Acrylic	15 Black 20 Polished Nickel 24 Satin Nickel	6"(w) x 6"(h) x 2.375"(ext)	1 x 8.2w, 90CRI 3000k LED	120V/277V 0-10V/Phase dimming	  

2700k, 3500k, 4000k color temperatures also available. Visit [oxygenlighting.com](http://oxygenlighting.com)

**GENERAL SPECIFICATIONS:**

- Cold rolled steel backplate and trim. • Acrylic shade is 1/8", matte white finish. • Unit mounts to deep 4" octagonal junction box or deep 4"x4" square junction box w/ a single device mud ring. • Approved for wall or ceiling mount applications. • Unit requires 2.5" deep junction box. • Driver mounts inside junction box. • Total luminaire power 10.1w.
- Visit [www.oxygenlighting.com](http://www.oxygenlighting.com) for technical cut sheets. • Oxygen reserves the right to modify designs at any time.



# BEACON SCONCE

ADA

LED

FLOURESCENT





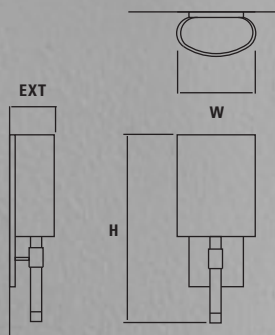
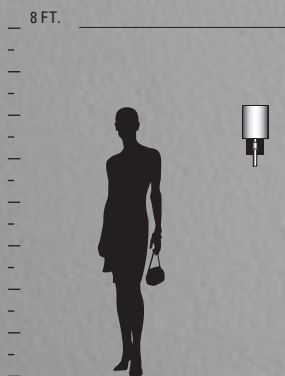



3-587-224





2-587-295

ITEM #	DIFFUSER	FINISH	DIMENSIONS	LAMPING	BALLAST	DRIVER	CERTIFICATION
<b>2-597-X24</b>	1 White Cotton 2 Matte White Acrylic	24 Satin Nickel	7"(w) x 16.5"(h) x 3.75"(ext)	1 x 26w quad 4-pin fluorescent (G24q-3)	Electronic, HPF, Programmed Start, Universal Voltage (120-277V)	-	  
<b>3-587-XXX</b>	1 White Cotton 2 Matte White Acrylic	24 Satin Nickel 95 Old World	7"(w) x 16.5"(h) x 3.75"(ext)	1 x 8.2w, 90CRI 3000K LED	-	120/277V 0-10V/Phase dimming	  

2700k, 3500k, 4000k color temperatures also available for LED models. Visit [oxygenlighting.com](http://oxygenlighting.com)

**GENERAL SPECIFICATIONS:**

- Cold rolled steel backplate and trim. • Clear, polished resin accent. • Fabric shade is white cotton. • Acrylic shade is 1/8", matte white finish. • White acrylic top and bottom lenses. • Unit mounts to 4" octagonal junction box. • Unit requires 2.5" deep junction box. • Driver mounts inside junction box. • Total luminaire power 10.4w.
- Visit [www.oxygenlighting.com](http://www.oxygenlighting.com) for technical cut sheets. • Oxygen reserves the right to modify designs at any time.

# BOLO SCONCE

ADA

LED



3-553-20

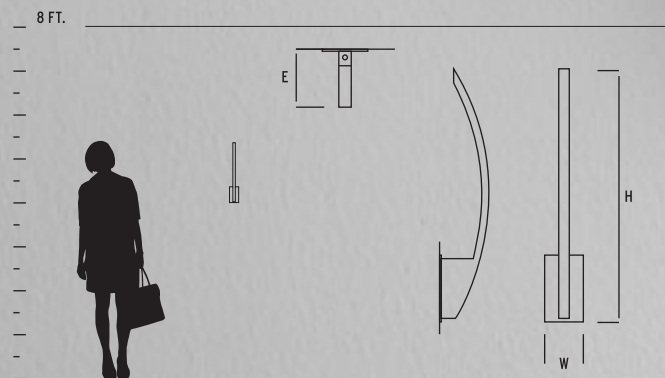





**3-553-15**



**3-553-24**

ITEM #	DIFFUSER	FINISH	DIMENSIONS	LAMPING	DRIVER	CERTIFICATION
<b>3-553-XX</b>	Matte White Acrylic	15 Black 20 Polished Nickel 24 Satin Nickel	2.75"(w) x 18"(h) x 3.5"(ext) w/o optional cover plate	1 x 12.1w, 90CRI 3000k LED	120V/277V 0-10V/Phase dimming	  

**GENERAL SPECIFICATIONS:**

- Cold rolled steel backplate and trim. • Acrylic shade is 1/8", matte white finish. • Unit mounts to deep 4"x4" square junction box w/ single device mud ring for small backplate.
- Unit mounts to deep 4" octagonal junction box or deep 4"x4" square junction box w/ single device mud ring for large backplate. • Supplied with two cover plate options: 4.75" x 6" for octagonal mounting & 2.75" x 4.75" for mounting to single device mud ring. • Approved for wall mount applications only. • Unit requires 2.5" deep junction box. • Driver mounts inside junction box. • Total luminaire power 14.5w. • Visit [www.oxygenlighting.com](http://www.oxygenlighting.com) for technical cut sheets. • Oxygen reserves the right to modify designs at any time.



# CHAMELEON SCONCE

ADA



LED

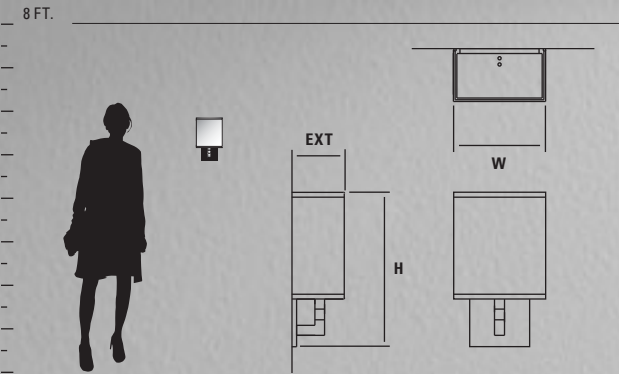

3-521-40





ITEM #	DIFFUSER	FINISH	DIMENSIONS	LAMPING	DRIVER	CERTIFICATION
3-521-XX	Matte White Acrylic	14 Polished Chrome 22 Oiled Bronze 24 Satin Nickel 40 Aged Brass	8"(w) x 11.75"(h) x 4"(ext)	1 x 8.2w, 90CRI 3000k LED	120/277V 0-10V/Phase dimming.	  

2700k, 3500k, 4000k color temperatures also available. Visit [oxygenlighting.com](http://oxygenlighting.com)

**GENERAL SPECIFICATIONS:**

• Cold rolled steel housing. • Frost resin accent. • Matte white acrylic lenses and shades are 1/8" thick. • Unit mounts to deep 4" octagonal junction box. • Unit requires 2.5" deep junction box. • Driver mounts inside junction box. • Total luminaire power 10.4w. • Visit [www.oxygenlighting.com](http://www.oxygenlighting.com) for technical cut sheets. • Oxygen reserves the right to modify designs at any time.

# CHAMELEON SCONCE

ADA

LED



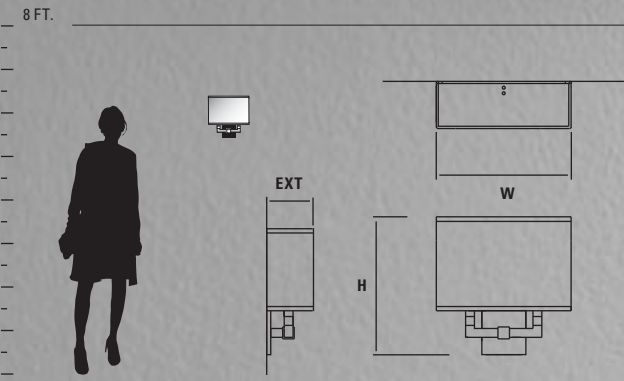

3-514-40





3-514-22

ITEM #	DIFFUSER	FINISH	DIMENSIONS	LAMPING	DRIVER	CERTIFICATION
3-514-XX	Matte White Acrylic	14 Polished Chrome 22 Oiled Bronze 24 Satin Nickel 40 Aged Brass	11.75"(w) x 11.5"(h) x 4"(ext)	1 x 10.1w, 90CRI 3000k LED	120/277V 0-10V/Phase dimming.	  

2700k, 3500k, 4000k color temperatures also available. Visit [oxygenlighting.com](http://oxygenlighting.com)

**GENERAL SPECIFICATIONS:**

• Cold rolled steel housing. • Frost resin accent. • Matte white acrylic lenses and shades are 1/8" thick. • Unit mounts to 4" octagonal junction box. • Unit requires 2.5" deep junction box. • Driver mounts inside junction box. • Total luminaire power 13.1w. • Visit [www.oxygenlighting.com](http://www.oxygenlighting.com) for technical cut sheets. • Oxygen reserves the right to modify designs at any time.



# CRESCENT SCONCE

ADA







LED

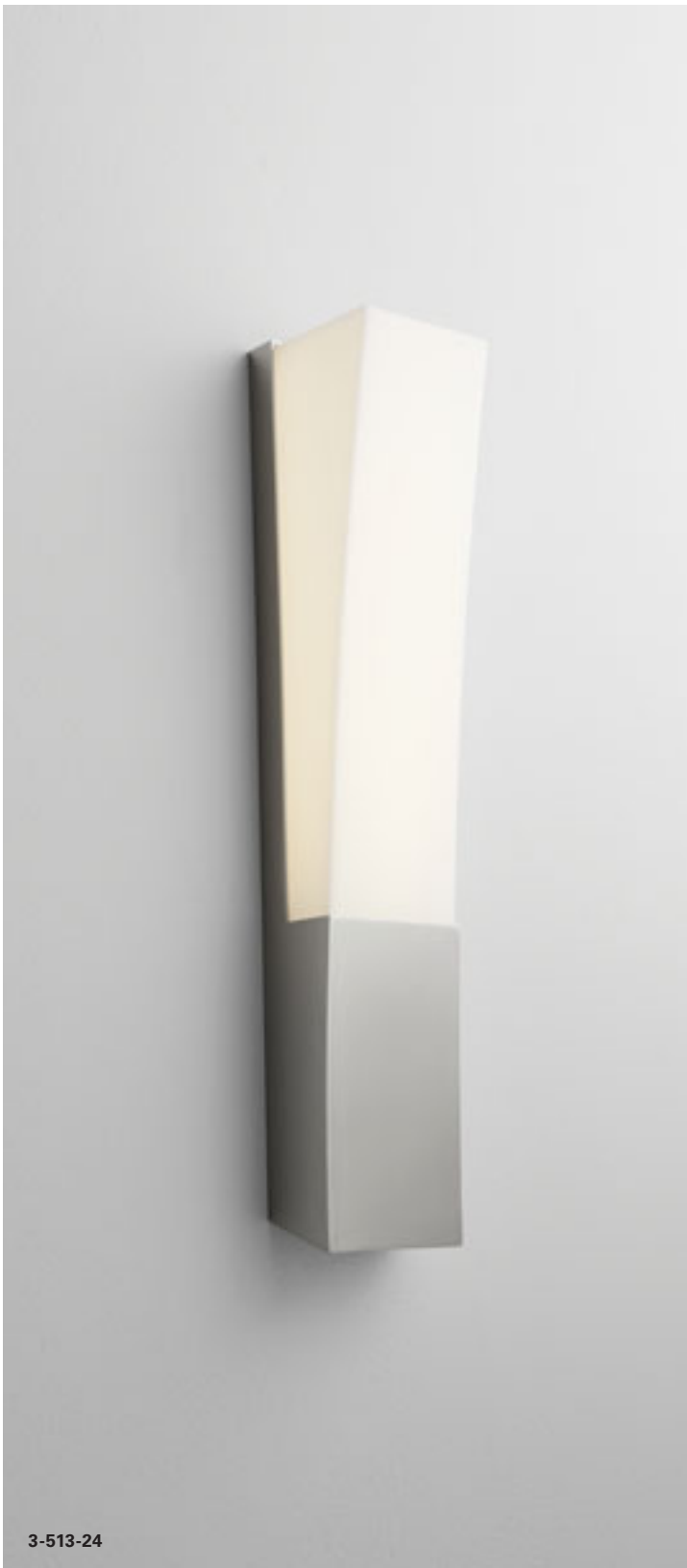

3-512-24





ITEM #	DIFFUSER	FINISH	DIMENSIONS	LAMPING	DRIVER	CERTIFICATION
<b>3-512-24</b> small	Matte White Acrylic	24 Satin Nickel	3.5"(w) x 14"(h) x 3.75"(ext)	1 x 10.1w, 90CRI 3000k LED	120/277V 0-10V/Phase dimming	  
<b>3-513-24</b> large	Matte White Acrylic	24 Satin Nickel	3.5"(w) x 18.75"(h) x 3.75"(ext)	1 x 10.1w, 90CRI 3000k LED	120/277V 0-10V/Phase dimming	  

2700k, 3500k, 4000k color temperatures also available. Visit [oxygenlighting.com](http://oxygenlighting.com)

**GENERAL SPECIFICATIONS:**

- Cold rolled steel housing. • Diffusers are 1/8" thick matte white acrylic. • Units mount to deep 4"x4" junction box or a deep 4"x4" junction box w/ single device mud ring.
- Approved for vertical mounting. • Approved for wall mount applications only. • Driver mounts inside junction box. • Total luminaire power 12.9w for 3-512-24 and 12.8w for 3-513-24. • Visit [www.oxygenlighting.com](http://www.oxygenlighting.com) for technical cut sheets. • Oxygen reserves the right to modify designs at any time.

# DUO SCONCE

ADA

LED



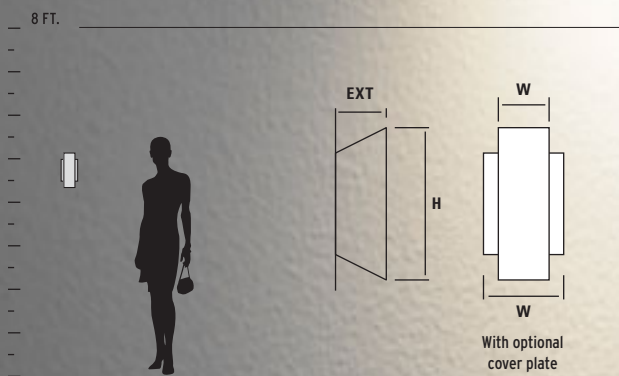

3-509-24

Shown with Optional Cover Plate (Included)





ITEM #	DIFFUSER	FINISH	DIMENSIONS	LAMPING	CERTIFICATION
<b>3-509-XX</b>	Frosted Glass	18 Gunmetal 24 Satin Nickel 40 Aged Brass	3"(w) x 9.25"(h) x 3"(ext) w/o optional cover plate	2 x 7w MAX GU10 120V LED ONLY (lamps not included)	  

**GENERAL SPECIFICATIONS:**

- Cold rolled steel housing.
- Frosted glass diffusers.
- Unit mounts to 2"x3" junction box.
- Supplied with 4.75"x6" cover plate for mounting to 4" octagonal junction box.
- Approved for vertical mounting.
- Approved for wall mount applications only.
- Visit [www.oxygenlighting.com](http://www.oxygenlighting.com) for technical cut sheets.
- Oxygen reserves the right to modify designs at any time.

# ELLIPSE SCONCE

ADA

LED



3-567-220









3-567-124



3-567-115

ITEM #	DIFFUSER	FINISH	DIMENSIONS	LAMPING	DRIVER	CERTIFICATION
3-567-XXX	1 White Opal Glass 2 Matte White Acrylic	15 Black 20 Polished Nickel 24 Satin Nickel	4.75"(w) x 9.625"(h) x 4"(ext)	1 x 6.2w, 90CRI 3000k LED	120V/277V 0-10V/Phase dimming	  

2700k, 3500k, 4000k color temperatures also available. Visit [oxygenlighting.com](http://oxygenlighting.com)

**GENERAL SPECIFICATIONS:**

- Cold rolled steel backplate and trim.
- Acrylic and glass shades are 1/8", matte white finish.
- Unit mounts to deep 4" octagonal junction box, deep 4"x4" square junction box or a deep 4"x4" square junction box w/ single device mud ring.
- Approved for wall mount applications only.
- Unit requires 2.5" deep junction box.
- Driver mounts inside junction box.
- Total luminaire power 7.1w.
- Visit [www.oxygenlighting.com](http://www.oxygenlighting.com) for technical cut sheets.
- Oxygen reserves the right to modify designs at any time.

# EPOCH SCONCE

ADA

LED

FLOURESCENT



3-564-240

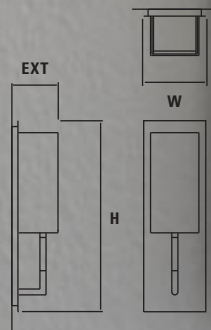









3-564-122



3-564-124

ITEM #	DIFFUSER	FINISH	DIMENSIONS	LAMPING	BALLAST	DRIVER	CERTIFICATION
<b>2-5154-XXX</b>	1 White Cotton 2 Matte White Acrylic	24 Satin Nickel	5.25"(w) x 15.75"(h) x 3.75"(ext)	1 x 18w quad 4-pin fluorescent (G24q-2)	Electronic, HPF, Programmed Start, Universal Voltage (120-277V)	--	  
<b>3-564-XXX</b>	1 White Cotton 2 Matte White Acrylic	22 Oiled Bronze 24 Satin Nickel 40 Aged Brass	5.25"(w) x 15.75"(h) x 3.75"(ext)	1 x 8.2w, 90CRI 3000k LED	--	120/277V 0-10V/Phase dimming.	  

2700k, 3500k, 4000k color temperatures also available for LED models. Visit [oxygenlighting.com](http://oxygenlighting.com)

**GENERAL SPECIFICATIONS:**

- Cold rolled steel backplate. • Steel tubing with frost resin accent. • Fabric shade is white cotton. • Acrylic shade is 1/8", matte white finish. • White acrylic top and bottom lenses. • Unit mounts to deep 4" octagonal junction box, deep 4"x4" square junction box or a deep 4"x4" square junction box w/ single device mud ring. • Unit requires 2.5" deep junction box. • Driver mounts inside junction box. • Toolless access to lamps for fluorescent models. • Total luminaire power 10.4w for LED models. • Visit [www.oxygenlighting.com](http://www.oxygenlighting.com) for technical cut sheets. • Oxygen reserves the right to modify designs at any time.

# FUGIT SCONCE

ADA

LED

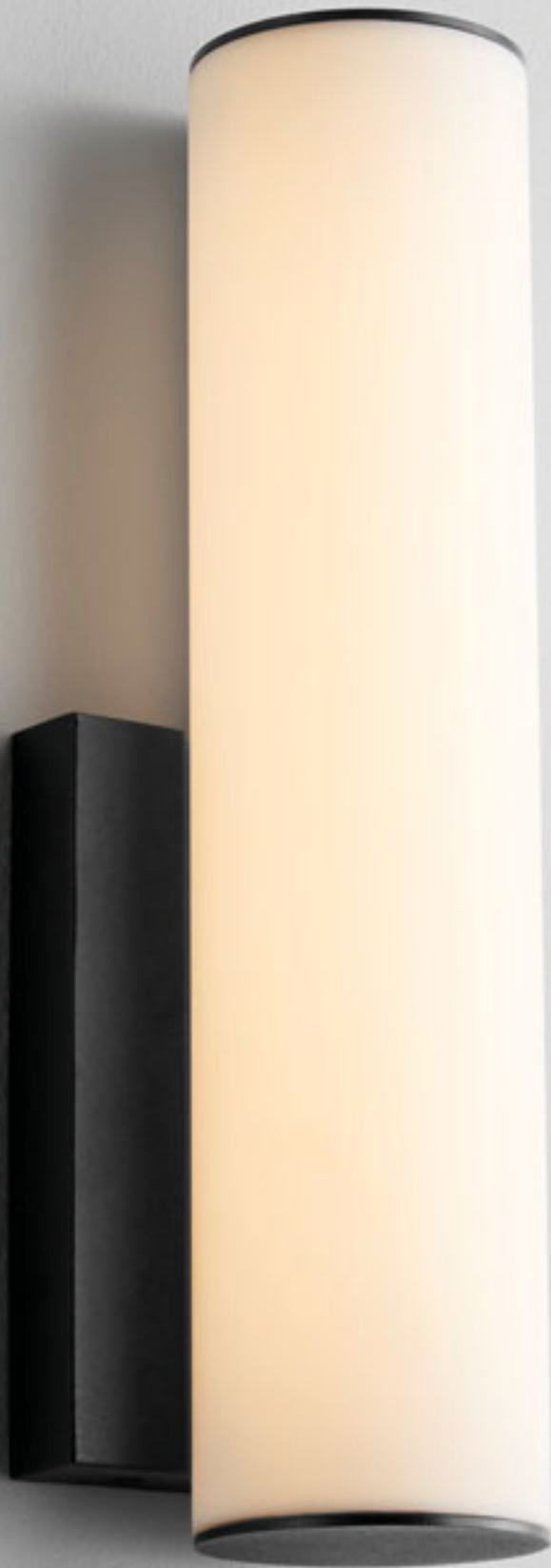

3-5010-15

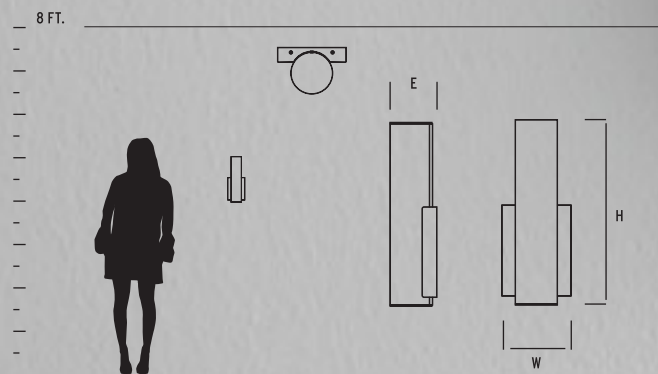





3-5010-40

3-5010-24

3-5010-20

ITEM #	DIFFUSER	FINISH	DIMENSIONS	LAMPING	DRIVER	CERTIFICATION
3-5010-XX	Matte White Acrylic	15 Black 20 Polished Nickel 24 Satin Nickel 40 Aged Brass	4.5"(w) x 12.125"(h) x 3.125"(ext)	1 x 9w, 90CRI 3000k LED	120V Triac dimming	  

**GENERAL SPECIFICATIONS:**

• Cold rolled steel backplate and trim. • Acrylic shade is 1/8", matte white finish. • Unit mounts to deep 4" octagonal junction box or deep 4"x4" square junction box w/ single device mud ring. • Unit requires 2.5" deep junction box. • Driver mounts inside junction box. • Total luminaire power 11.3w. • Visit [www.oxygenlighting.com](http://www.oxygenlighting.com) for technical cut sheets. • Oxygen reserves the right to modify designs at any time.



# HALO SCONCE

ADA





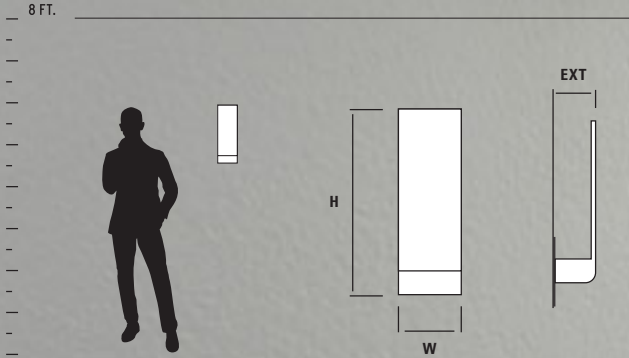

LED



3-515-25





ITEM #	DIFFUSER	FINISH	DIMENSIONS	LAMPING	DRIVER	CERTIFICATION
<b>3-515-XX</b>	Matte White Acrylic	14 Polished Chrome 24 Satin Nickel 25 Satin Copper 40 Aged Brass	5.5"(w) x 18"(h) x 3.25"(ext)	1 x 10.1w, 90CRI 3000k LED	120/277V 0-10V/Phase dimming	  
<b>3-535-XX</b> small	Matte White Acrylic	14 Polished Chrome 24 Satin Nickel 25 Satin Copper 40 Aged Brass	5.5"(w) x 12.625"(h) x 3.25"(ext)	1 x 10.1w, 90CRI 3000k LED	120/277V 0-10V/Phase dimming	  

2700k, 3500k, 4000k color temperatures also available. Visit [oxygenlighting.com](http://oxygenlighting.com)

**GENERAL SPECIFICATIONS:**

- Cold rolled steel housing. • Matte white acrylic diffuser. • Unit mounts to horizontal 2"x3" junction box or a 4"x4" junction box. • Approved for vertical mounting. • Approved for wall mount applications only. • Total luminaire power 13w. • Visit [www.oxygenlighting.com](http://www.oxygenlighting.com) for technical cut sheets. • Oxygen reserves the right to modify designs at any time.

# ICON SCONCE

ADA

LED



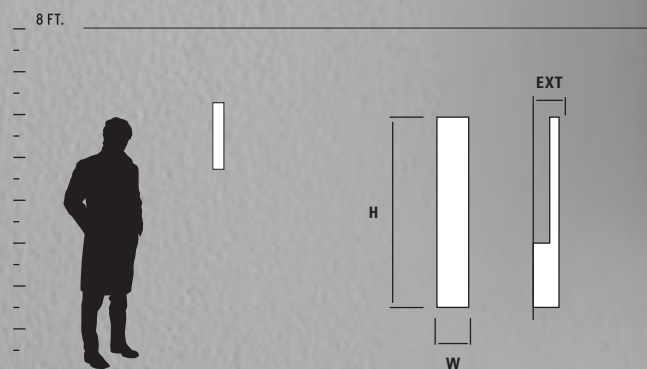

3-511-24

Shown With Optional Cover Plate (Included)





ITEM #	DIFFUSER	FINISH	DIMENSIONS	LAMPING	DRIVER	CERTIFICATION
3-511-XX	Matte White Acrylic	14 Polished Chrome 22 Oiled Bronze 24 Satin Nickel 40 Aged Brass	3.25"(w) x 19.5"(h) x 2.5"(ext) w/o optional cover plate	1 x 10.1w, 90CRI 3000k LED	120/277V 0-10V/Phase dimming	  

2700k, 3500k, 4000k color temperatures also available. Visit [oxygenlighting.com](http://oxygenlighting.com)

**GENERAL SPECIFICATIONS:**

- Cold rolled steel housing. • Matte white acrylic diffuser. • Unit mounts to 2"x3" junction box. • Supplied with 4.75"x6" cover plate for mounting to 4" octagonal junction box.
- Approved for vertical mounting. • Approved for wall mount applications only. • Total luminaire power 12.8w. • Visit [www.oxygenlighting.com](http://www.oxygenlighting.com) for technical cut sheets.
- Oxygen reserves the right to modify designs at any time.

# KIKO SCONCE

ADA

LED



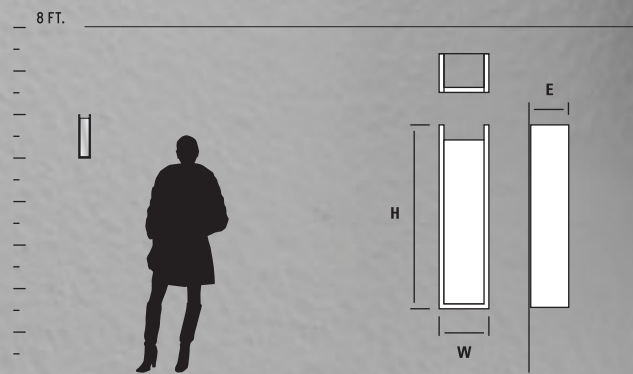

3-345-24







ITEM #	DIFFUSER	FINISH	DIMENSIONS	LAMPING	DRIVER	CERTIFICATION
3-545-XX	Matte White Acrylic	20 Polished Nickel 24 Satin Nickel	3.25"(w) x 12"(h) x 2.5"(ext)	1 x 10.1w, 90CRI 3000k LED	120/277V 0-10V/Phase dimming	  

2700k, 3500k, 4000k color temperatures also available. Visit [oxygenlighting.com](http://oxygenlighting.com)

**GENERAL SPECIFICATIONS:**

- Cold-rolled steel housing. • Diffuser is 1/8" thick matte white acrylic. • Unit mounts to deep 2"x3" junction box or a deep 4"x4" junction box w/ single device mud ring.
- Approved for wall mount applications only. • Unit requires 2.5" deep junction box. • Driver mounts inside junction box. • Total luminaire power 12.8w.
- Visit [www.oxygenlighting.com](http://www.oxygenlighting.com) for technical cut sheets. • Oxygen reserves the right to modify designs at any time.

# MAGNETA SCONCE

ADA

LED



3-528-140

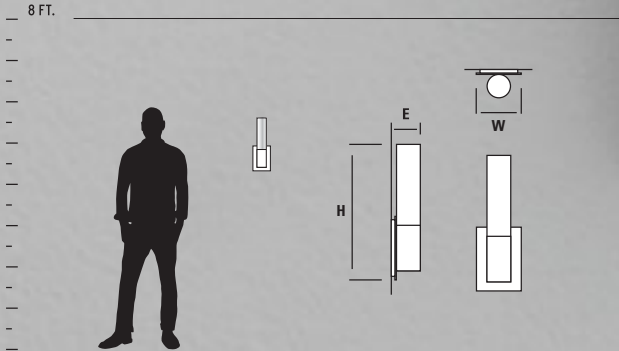









3-528-24



3-528-124

ITEM #	DIFFUSER	FINISH	DIMENSIONS	LAMPING	DRIVER	CERTIFICATION
3-528-XX	Matte White Acrylic	24 Satin Nickel 40 Aged Brass	4.75"(w) x 14.375"(h) x 3.25"(ext)	1 x 11.9w, 90CRI 3000k LED	120/277V 0-10V/Phase dimming	  
3-528-1XX	1 Matte Opal Glass	24 Satin Nickel 40 Aged Brass	4.75"(w) x 14.375"(h) x 3.25"(ext)	1 x 11.9w, 90CRI 3000k LED	120/277V 0-10V/Phase dimming	  

2700k, 3500k, 4000k color temperatures also available. Visit [oxygenlighting.com](http://oxygenlighting.com)

**GENERAL SPECIFICATIONS:**

- Cold-rolled steel housing.
- Closed top diffuser is 1/8" thick matte white acrylic or matte opal glass.
- Diffuser screws onto housing with integral threaded fitting.
- Unit mounts to 2"x3" junction box or a 4" octagonal junction box.
- Approved for wall mount application only.
- Total luminaire power 15.2w.
- Visit [www.oxygenlighting.com](http://www.oxygenlighting.com) for technical cut sheets.
- Oxygen reserves the right to modify designs at any time.

# MAGNUM SCONCE

ADA

LED



3-518-24











3-518-124



3-518-25



3-518-40

ITEM #	DIFFUSER	FINISH	DIMENSIONS	LAMPING	DRIVER	CERTIFICATION
<b>3-518-XX</b>	Matte White Acrylic	24 Satin Nickel 25 Satin Copper 40 Aged Brass	4.75"(w) x 18.75"(h) x 4"(ext)	1 x 11.9w, 90CRI 3000k LED	120/277V 0-10V/Phase dimming	  
<b>3-518-1XX</b>	1 Matte Opal Glass	24 Satin Nickel 25 Satin Copper 40 Aged Brass	4.75"(w) x 18.75"(h) x 4"(ext)	1 x 11.9w, 90CRI 3000k LED	120/277V 0-10V/Phase dimming	  

2700k, 3500k, 4000k color temperatures also available. Visit [oxygenlighting.com](http://oxygenlighting.com)

**GENERAL SPECIFICATIONS:**

- Cold-rolled steel housing. • Closed top diffuser is 1/8" thick matte white acrylic or matte opal glass. • Diffuser screws onto housing with integral threaded fitting. • Unit mounts to 2"x3" junction box or a 4" octagonal junction box • Approved for wall mount application only. • Total luminaire power 15.1w. • Visit [www.oxygenlighting.com](http://www.oxygenlighting.com) for technical cut sheets. • Oxygen reserves the right to modify designs at any time.



# METRIX SCONCE

ADA

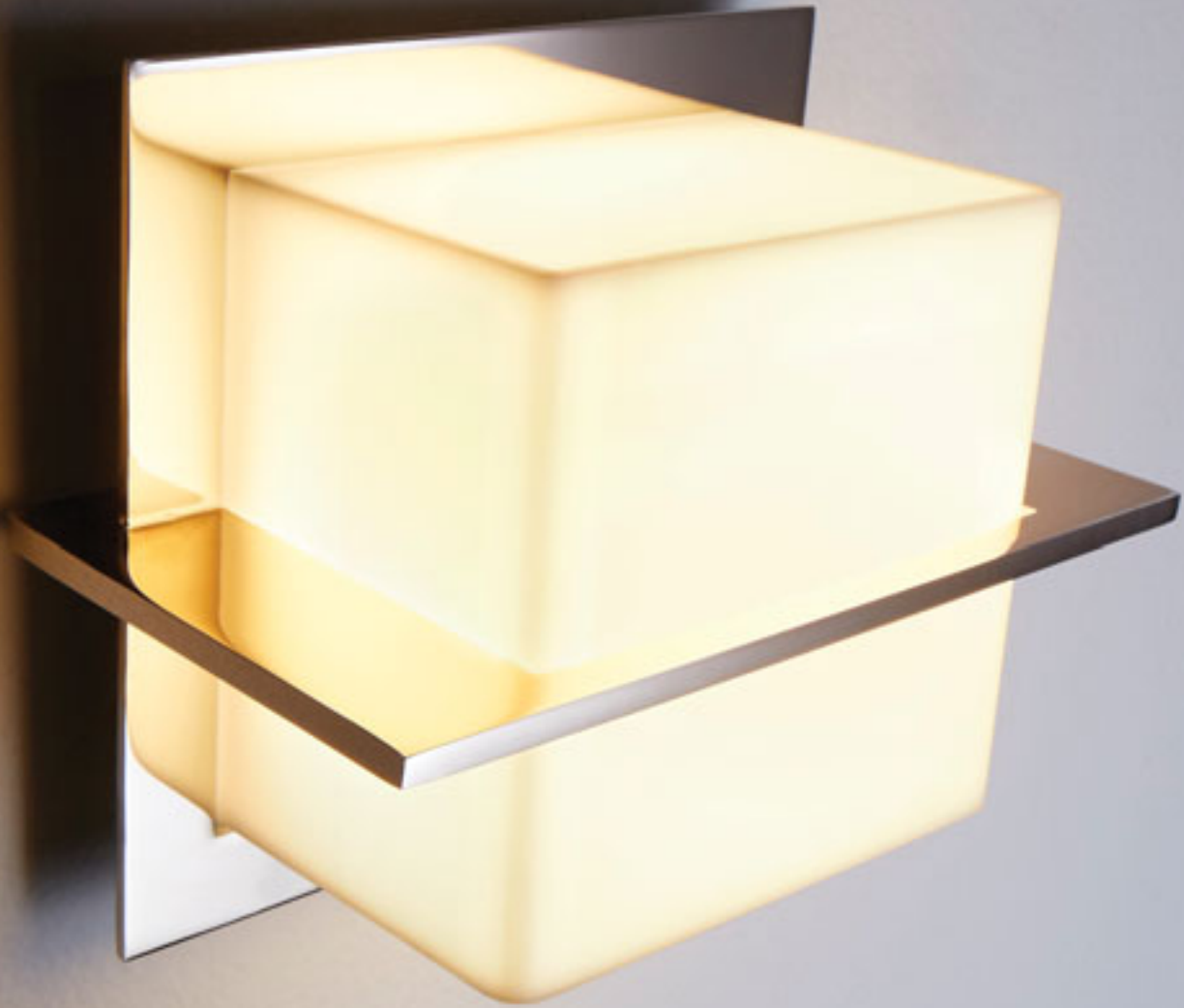

LED

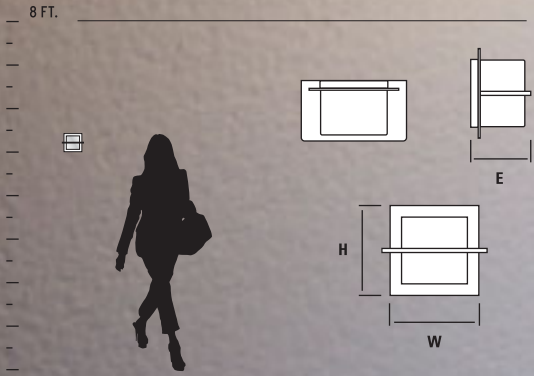

3-541-20





ITEM #	DIFFUSER	FINISH	DIMENSIONS	LAMPING	DRIVER	CERTIFICATION
3-541-XX	Matte White Acrylic	20 Polished Nickel 24 Satin Nickel	5.75"(w) x 5.75"(h) x 3.875"(ext)	1 x 8.2w, 90CRI 3000k LED	120/277V 0-10V/Phase dimming	  

2700k, 3500k, 4000k color temperatures also available. Visit [oxygenlighting.com](http://oxygenlighting.com)

**GENERAL SPECIFICATIONS:**

- Cold-rolled steel housing. • Diffuser is 1/8" thick matte white acrylic. • Unit mounts to deep 2"x3" or 4" octagonal junction box. • Driver mounts inside junction box. • Unit requires deep 2.5" deep junction box. • Approved for wall and ceiling mount applications. • Total luminaire power 10.5w. • Visit [www.oxygenlighting.com](http://www.oxygenlighting.com) for technical cut sheets. • Oxygen reserves the right to modify designs at any time.

# MIES SCONCE

ADA



LED

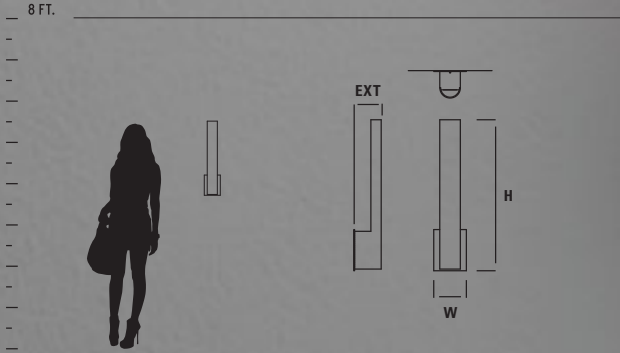

3-520-24





ITEM #	DIFFUSER	FINISH	DIMENSIONS	LAMPING	DRIVER	CERTIFICATION
<b>3-520-XX</b>	Matte White Acrylic	14 Polished Chrome 24 Satin Nickel 40 Aged Brass	3"(w) x 21.75"(h) x 4"(ext) w/o optional cover plate	1 x 10.1w, 90CRI 3000k LED	120/277V 0-10V/Phase dimming	  

2700k, 3500k, 4000k color temperatures also available. Visit [oxygenlighting.com](http://oxygenlighting.com)

**GENERAL SPECIFICATIONS:**

- Cold rolled steel housing. • Matte white acrylic diffuser. • Unit mounts to 2"x3" junction box. • Supplied with 4.75"x6" cover plate for mounting to 4" octagonal junction box.
- Approved for vertical mounting. • Approved for wall mount applications only. • Total luminaire power 12.7w. • Visit [www.oxygenlighting.com](http://www.oxygenlighting.com) for technical cut sheets.
- Oxygen reserves the right to modify designs at any time.

# MIRAGE SCONCE

ADA

LED



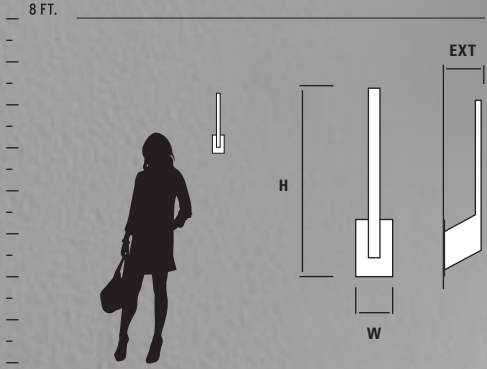

3-516-24







3-516-40

ITEM #	DIFFUSER	FINISH	DIMENSIONS	LAMPING	DRIVER	CERTIFICATION
3-516-XX	Matte White Acrylic	24 Satin Nickel 40 Aged Brass	4.75"(w) x 19.125"(h) x 4"(ext)	1 x 12.2w, 90CRI 3000k LED	120/277V 0-10V/Phase dimming	  

2700k, 3500k, 4000k color temperatures also available. Visit [oxygenlighting.com](http://oxygenlighting.com)

**GENERAL SPECIFICATIONS:**

• Cold rolled steel housing. • Matte white acrylic diffuser. • Unit mounts to 2"x3" or 4" octagonal junction box. • Approved for vertical mounting. • Approved for wall mount applications only. • Total luminaire power 15w. • Visit [www.oxygenlighting.com](http://www.oxygenlighting.com) for technical cut sheets. • Oxygen reserves the right to modify designs at any time.

# OLIO SCONCE

ADA

LED



3-538-24

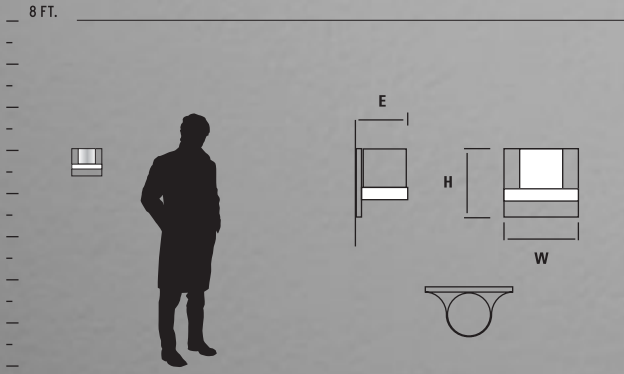





3-538-22



3-538-24

ITEM #	DIFFUSER	FINISH	DIMENSIONS	LAMPING	DRIVER	CERTIFICATION
3-538-XX	Matte Opal Glass	22 Oiled Bronze 24 Satin Nickel	7"(w) x 5.5"(h) x 4"(ext)	1 x 8.2w, 90CRI 3000k LED	120/277V 0-10V/Phase dimming	  

2700k, 3500k, 4000k color temperatures also available. Visit [oxygenlighting.com](http://oxygenlighting.com)

**GENERAL SPECIFICATIONS:**

- Cold-rolled steel housing. • Diffuser is 1/8" thick matte opal glass. • Diffuser screws onto housing with integral threaded fitting. • Unit mounts to deep 4" octagonal junction box or deep 4"x4" square junction box. • Approved for wall applications only. • Unit requires 2.5" deep junction box. • Driver mounts inside junction box. • Total luminaire power 10.1w.
- Visit [www.oxygenlighting.com](http://www.oxygenlighting.com) for technical cut sheets. • Oxygen reserves the right to modify designs at any time.

# OLIO SCONCE

ADA



LED

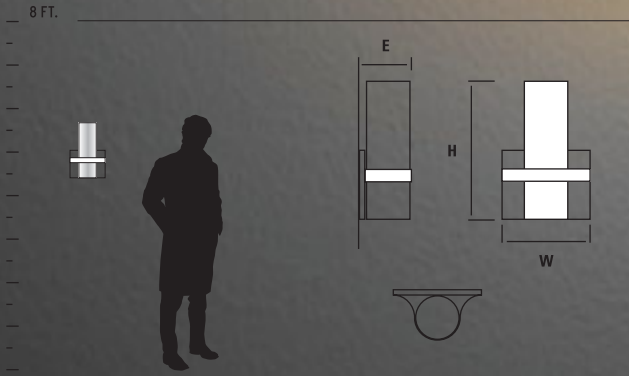

3-539-22





ITEM #	DIFFUSER	FINISH	DIMENSIONS	LAMPING	DRIVER	CERTIFICATION
3-539-XX	Matte Opal Glass	22 Oiled Bronze 24 Satin Nickel	7"(w) x 11"(h) x 4"(ext)	2 x 8.2w, 90CRI 3000k LED	120/277V 0-10V/Phase dimming	  

2700k, 3500k, 4000k color temperatures also available. Visit [oxygenlighting.com](http://oxygenlighting.com)

**GENERAL SPECIFICATIONS:**

- Cold-rolled steel housing.
- Diffuser is 1/8" thick matte opal glass.
- Diffuser screws onto housing with integral threaded fitting.
- Unit mounts to deep 4" octagonal junction box or deep 4"x4" square junction box.
- Approved for wall applications only.
- Unit requires 2.5" deep junction box.
- Driver mounts inside junction box.
- Total luminaire power 20.2w.
- Visit [www.oxygenlighting.com](http://www.oxygenlighting.com) for technical cut sheets.
- Oxygen reserves the right to modify designs at any time.



# ORION SCONCE

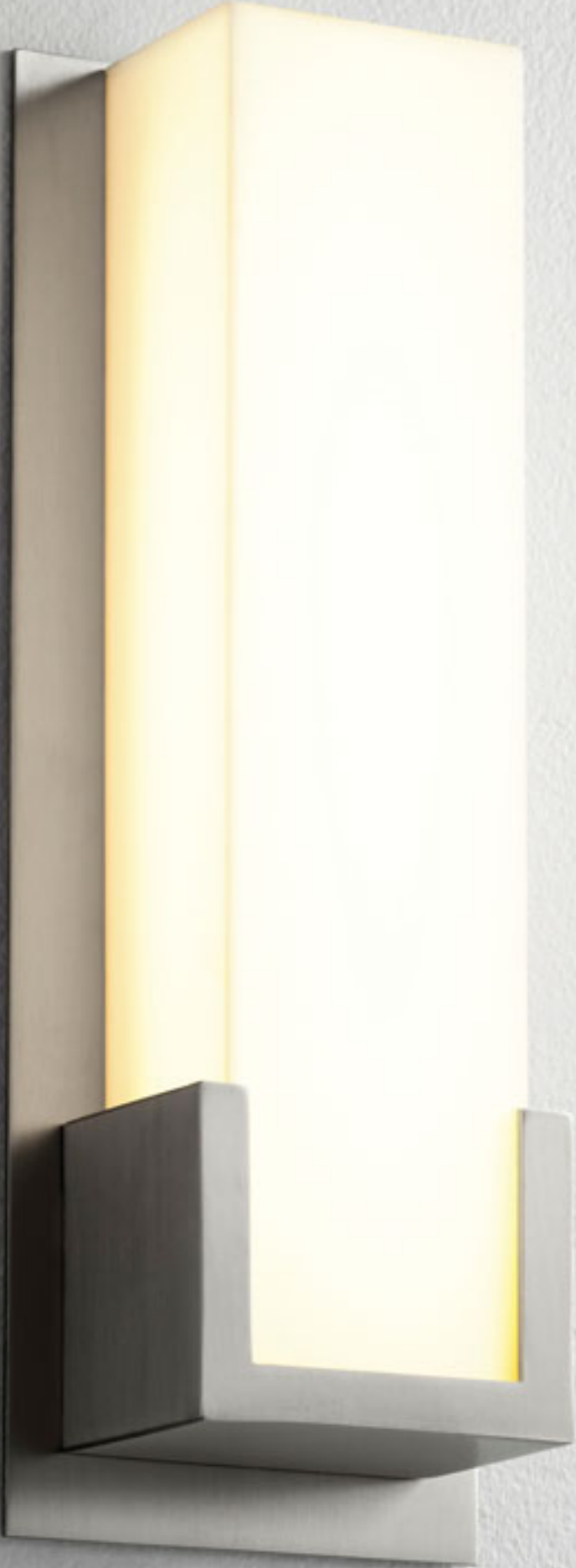

ADA LED

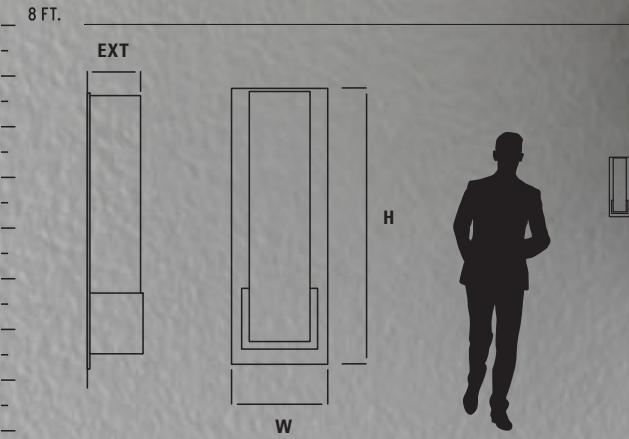

3-540-24





ITEM #	DIFFUSER	FINISH	DIMENSIONS	LAMPING	DRIVER	CERTIFICATION
3-540-XX	Matte White Acrylic	14 Polished Chrome 24 Satin Nickel 40 Aged Brass	4.75"(w) x 13.5"(h) x 2.75"(ext)	1 x 12.2w, 90CRI 3000k LED	120/277V 0-10V/Phase dimming	  

2700k, 3500k, 4000k color temperatures also available. Visit [oxygenlighting.com](http://oxygenlighting.com)

**GENERAL SPECIFICATIONS:**

- Cold rolled steel backplate and trim.
- Acrylic shade is 1/8", matte white finish.
- Unit mounts to horizontal deep 2"x3" junction box, a deep 4" octagonal junction box or a deep 4"x4" junction box w/ single device mud ring.
- Approved for wall mount applications only.
- Unit requires 2.5" deep junction box.
- Driver mounts inside junction box.
- Total luminaire power 15.4w.
- Visit [www.oxygenlighting.com](http://www.oxygenlighting.com) for technical cut sheets.
- Oxygen reserves the right to modify designs at any time.

# PATHWAYS SCONCE





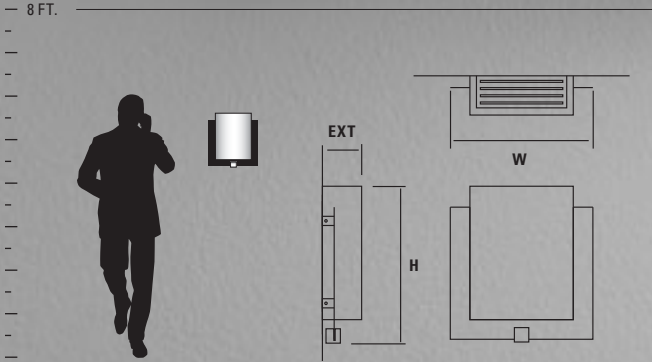

ADA LED EM



3-523-224





ITEM #	DIFFUSER	FINISH	DIMENSIONS	LAMPING	BALLAST	DRIVER	CERTIFICATION
<b>3-523-2XX</b>	2 Matte White Acrylic	24 Satin Nickel 95 Old World	13.75"(w) x 15"(h) x 3.75"(ext)	1 x 10.1w, 90CRI 3000k LED	-	120/277V 0-10V/Phase dimming	  
<b>3-523-2XX-EM</b>	2 Matte White Acrylic	24 Satin Nickel 95 Old World	13.75"(w) x 15"(h) x 3.75"(ext)	1 x 10.1w, 90CRI 3000k LED	-	120/277V 0-10V/Phase dimming	   

2700k, 3500k, 4000k color temperatures also available for non EM LED models. Visit [oxygenlighting.com](http://oxygenlighting.com)

**GENERAL SPECIFICATIONS:**

- Cold rolled steel housing and trim. • Acrylic diffusers are 1/8" thick, finish as specified. • Unit mounts to 4" octagonal junction box. • Approved for wall mount applications only
- Total luminaire power 12.9w for LED models. • Visit [www.oxygenlighting.com](http://www.oxygenlighting.com) for technical cut sheets. • Oxygen reserves the right to modify designs at any time.

**EMERGENCY BATTERY BACKUP MODELS (EM)**

- ETL required 90 minute emergency battery run time • 32 hour recharge time.

# PEBBLE SCONCE

FLOURESCENT





3-650-1314







2-5156-124

ITEM #	DIFFUSER	FINISH	DIMENSIONS	LAMPING	BALLAST	CERTIFICATION
2-5156-124	1 White Opal Glass	24 Satin Nickel	6"(w) x 12.75"(h) x 5.5"(ext)	1 x 18w quad 4-pin fluorescent (G24q-2)	Electronic, HPF, Programmed Start, Universal Voltage (120-277V)	 

**GENERAL SPECIFICATIONS:**

• Cast and machined steel fittings. • Diffuser screws onto housing with integral threaded fitting. • Glass diffusers are 1/8" thick white opal duplex glass. • Open top. • Units mounts to 4" octagonal junction box. • Visit [www.oxygenlighting.com](http://www.oxygenlighting.com) for technical cut sheets. • Oxygen reserves the right to modify designs at any time.

# POLARIS SCONCE





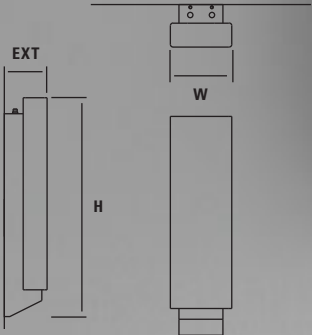

ADA LED EM



3-522-24





ITEM #	DIFFUSER	FINISH	DIMENSIONS	LAMPING	DRIVER	CERTIFICATION
3-522-24	Matte White Acrylic	24 Satin Nickel	5.75"(w) x 20.5"(h) x 4"(ext)	1 x 10.1w, 90CRI 3000k LED	120/277V 0-10V/Phase dimming	  
3-522-24-EM	Matte White Acrylic	24 Satin Nickel	5.75"(w) x 20.5"(h) x 4"(ext)	1 x 10.1w, 90CRI 3000k LED	120/277V 0-10V/Phase dimming	   

2700k, 3500k, 4000k color temperatures also available for non EM LED models. Visit [oxygenlighting.com](http://oxygenlighting.com)

**GENERAL SPECIFICATIONS:**

• Cold rolled steel housing. • Acrylic diffusers are 1/8" thick matte white with closed top and bottom. • Unit mounts to 4" octagonal junction box. • Approved for wall mount applications only • Total luminaire power 15.4w. • Visit [www.oxygenlighting.com](http://www.oxygenlighting.com) for technical cut sheets. • Oxygen reserves the right to modify designs at any time.

**EMERGENCY BATTERY BACKUP MODELS (EM)**

• ETL required 90 minute emergency battery run time • 32 hour recharge time.

# PROFILE SCONCE

ADA

LED



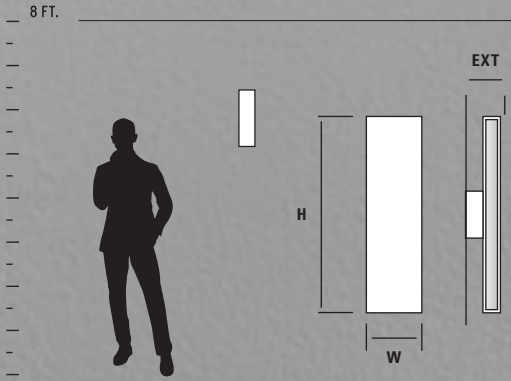

**3-517-14**  
Shown With Optional Cover Plate (Included)





**3-517-24**

ITEM #	DIFFUSER	FINISH	DIMENSIONS	LAMPING	DRIVER	CERTIFICATION
<b>3-517-XX</b>	Matte White Acrylic	14 Polished Chrome 24 Satin Nickel	4.5"(w) x 16"(h) x 3"(ext) w/o optional plate	2 x 12.2w, 90CRI 3000k LED	120/277V 0-10V/Phase dimming	  

2700k, 3500k, 4000k color temperatures also available. Visit [oxygenlighting.com](http://oxygenlighting.com)

**GENERAL SPECIFICATIONS:**

- Cold rolled steel housing and trim.
- Matte white acrylic diffuser.
- Unit mounts to 2" x 3" junction box.
- Supplied with 4.75" x 6" cover plate for mounting to 4" octagonal junction box.
- Approved for vertical mounting.
- Approved for wall mount applications only.
- Total luminaire power 29.8w.
- Visit [www.oxygenlighting.com](http://www.oxygenlighting.com) for technical cut sheets.
- Oxygen reserves the right to modify designs at any time.



# REFLEX SCONCE

ADA

LED



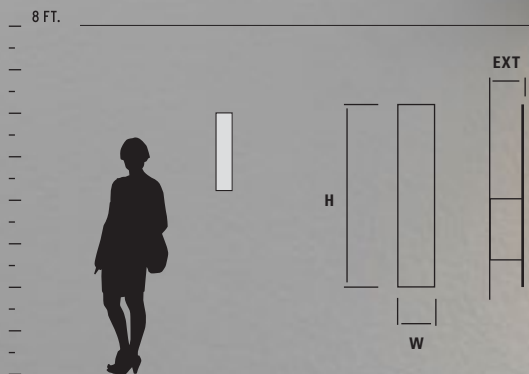

3-504-24

Shown With Optional Cover Plate (Included)





ITEM #	DIFFUSER	FINISH	DIMENSIONS	LAMPING	CERTIFICATION
<b>3-504-XX</b>	Perforated Metal	14 Polished Chrome 24 Satin Nickel 25 Satin Copper 40 Aged Brass	4"(w) x 20"(h) x 3.5"(ext) w/o optional plate	2 x 7w MAX GU10 120V LED ONLY (lamps not included)	  

**GENERAL SPECIFICATIONS:**

• Cold rolled steel housing and trim. • Unit mounts to 2" x 3" junction box. • Supplied with 4.75" x 6" cover plate for mounting to 4" octagonal junction box. • Approved for vertical mounting. • Approved for wall mount applications only. • Visit [www.oxygenlighting.com](http://www.oxygenlighting.com) for technical cut sheets. • Oxygen reserves the right to modify designs at any time.

# SIREN SCONCE

ADA



LED

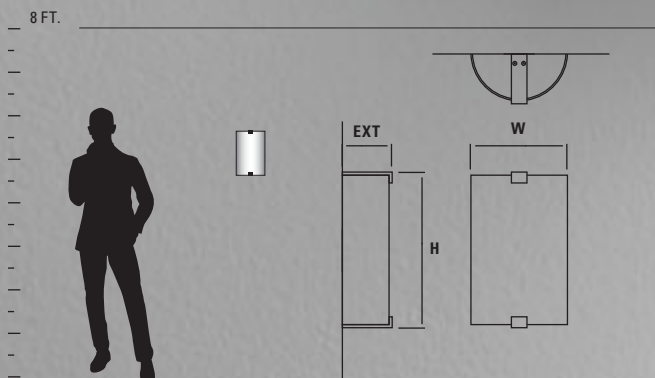

3-563-124





ITEM #	DIFFUSER	FINISH	DIMENSIONS	LAMPING	DRIVER	CERTIFICATION
3-563-XXX	1 White Opal Glass 2 Matte White Acrylic	14 Polished Chrome 24 Satin Nickel	7.75"(w) x 12.5"(h) x 4"(ext)	1 x 10.1w, 90CRI 3000k LED	120/277V 0-10V/Phase dimming	  

2700k, 3500k, 4000k color temperatures also available. Visit [www.oxygenlighting.com](http://www.oxygenlighting.com)

**GENERAL SPECIFICATIONS:**

- Cold rolled steel housing. • Cast steel trim. • Glass diffuser is 1/4" thick white opal duplex glass. • Acrylic shades are 1/8" thick. • White acrylic top and bottom lense with acrylic diffuser options. • Perforated steel top and bottom lense with white opal glass option. • Unit mounts to 4" octagonal junction box. • Approved for wall mount application only. • Total luminaire power 13.2w. • Visit [www.oxygenlighting.com](http://www.oxygenlighting.com) for technical cut sheets. • Oxygen reserves the right to modify designs at any time.

# SONGBIRD SCONCE

ADA

LED



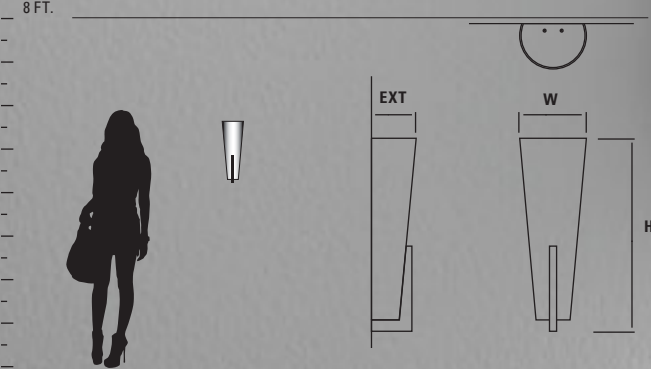

3-589-124





3-589-124

ITEM #	DIFFUSER	FINISH	DIMENSIONS	LAMPING	DRIVER	CERTIFICATION
3-589-124	1 Matte Opal Glass	24 Satin Nickel	6"(w) x 17"(h) x 4"(ext)	1 x 10.1w, 90CRI 3000k LED	120/277V 0-10V/Phase dimming	  

2700k, 3500k, 4000k color temperatures also available. Visit [oxygenlighting.com](http://oxygenlighting.com)

**GENERAL SPECIFICATIONS:**

• Cold rolled steel housing. • Cast steel trim. • Acrylic diffusers are 1/8" thick, finish as specified. • Glass diffuser is 1/4" thick white opal duplex glass. • All units mount to vertical 2"x3" or 4" octagonal junction box. • Approved for wall mount application only. • Total luminaire power 13.3w. • Visit [www.oxygenlighting.com](http://www.oxygenlighting.com) for technical cut sheets. • Oxygen reserves the right to modify designs at any time.



# TEMPUS SCONCE

ADA

LED



3-5000-24

8 FT.

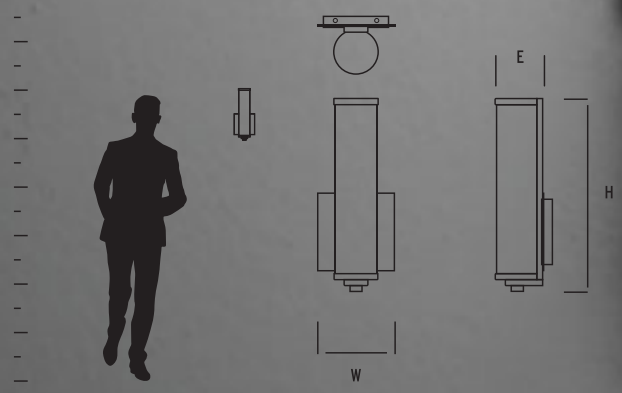





3-5000-15



3-5000-40



3-5000-20

ITEM #	DIFFUSER	FINISH	DIMENSIONS	LAMPING	DRIVER	CERTIFICATION
3-5000-XX	Matte White Acrylic	15 Black 20 Polished Nickel 24 Satin Nickel 40 Aged Brass	5.125"(w) x 12.75"(h) x 4"(ext)	1 x 9w, 90CRI 3000k LED	120V Triac dimming	  

**GENERAL SPECIFICATIONS:**

- Cold rolled steel backplate and trim. • Acrylic shade is 1/8", matte white finish. • Unit mounts to deep 4" octagonal junction box or deep 4"x4" square junction box w/ single device mud ring. • Unit requires 2.5" deep junction box. • Driver mounts inside junction box. • Total luminaire power 11.3w. • Visit [www.oxygenlighting.com](http://www.oxygenlighting.com) for technical cut sheets. • Oxygen reserves the right to modify designs at any time.

# UNO SCONCE

ADA



LED

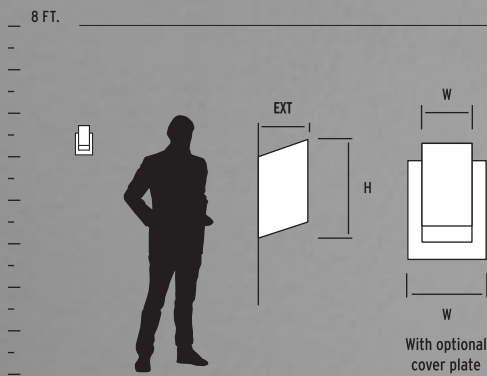

3-500-18





ITEM #	DIFFUSER	FINISH	DIMENSIONS	LAMPING	CERTIFICATION
<b>3-500-XX</b>	Frosted Glass	18 Gunmetal 24 Satin Nickel 40 Aged Brass	3"(w) x 6.75"(h) x 3"(ext) w/o optional cover plate	1 x 7w MAX GU10 120V LED ONLY (lamp not included)	  

**GENERAL SPECIFICATIONS:**

• Cold rolled steel housing. • Frosted glass diffuser. • Unit mounts to 2"x3" junction box. • Supplied with 4.75"x6" cover plate for mounting to 4" octagonal junction box. • Approved for vertical mounting. • Approved for wall mount applications only. • Visit [www.oxygenlighting.com](http://www.oxygenlighting.com) for technical cut sheets. • Oxygen reserves the right to modify designs at any time.

# VEGA SCONCE

ADA

LED



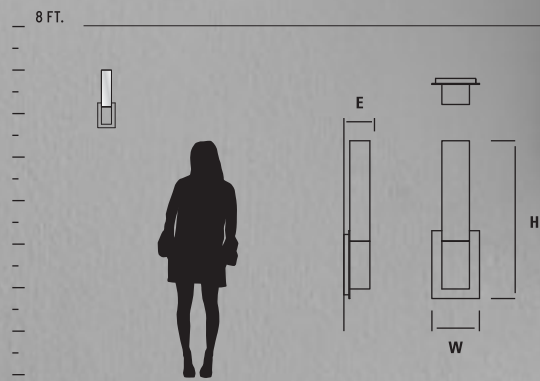

3-519-20





3-519-24

ITEM #	DIFFUSER	FINISH	DIMENSIONS	LAMPING	DRIVER	CERTIFICATION
3-519-XX	Matte White Acrylic	20 Polished Nickel 24 Satin Nickel	4.75"(w) x 15.75"(h) x 2.625"(ext)	1 x 12.2w, 90CRI 3000k LED	120/277V 0-10V/Phase dimming	  

2700k, 3500k, 4000k color temperatures also available. Visit [oxygenlighting.com](http://oxygenlighting.com)

**GENERAL SPECIFICATIONS:**

• Cold-rolled steel housing. • Diffuser is 1/8" thick matte white acrylic. • Unit mounts to 2"x3" or 4" octagonal junction box. • Approved for wall mount applications only. • Total luminaire power 15.5w. • Visit [www.oxygenlighting.com](http://www.oxygenlighting.com) for technical cut sheets. • Oxygen reserves the right to modify designs at any time.



# VELA SCONCE

ADA

LED



3-527-24

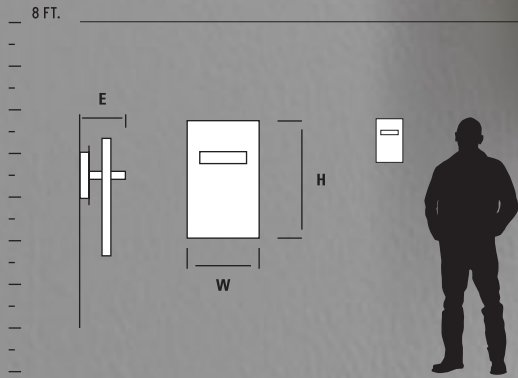





3-527-20



3-527-22

ITEM #	DIFFUSER	FINISH	DIMENSIONS	LAMPING	DRIVER	CERTIFICATION
3-527-XX	Matte White Acrylic	20 Polished Nickel 22 Oiled Bronze 24 Satin Nickel	6.875"(w) x 12"(h) x 4"(ext)	2 x 8.2w, 90CRI 3000k LED	120/277V 0-10V/Phase dimming	  

2700k, 3500k, 4000k color temperatures also available. Visit [oxygenlighting.com](http://oxygenlighting.com)

**GENERAL SPECIFICATIONS:**

- Cold-rolled steel housing. • Diffuser is 1/8" thick matte white acrylic. • Unit mounts to 4" octagonal junction box. • Approved for wall mount applications only. • Unit requires 2.5" deep junction box. • Driver mounts inside junction box. • Total luminaire power 20.2w. • Visit [www.oxygenlighting.com](http://www.oxygenlighting.com) for technical cut sheets. • Oxygen reserves the right to modify designs at any time.

# WAVE SCONCE

ADA

LED



3-5020-24

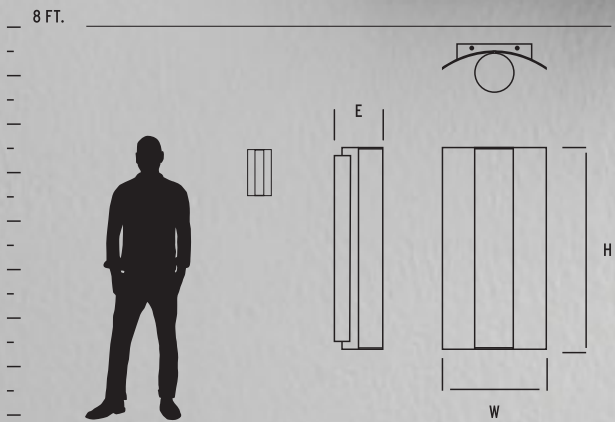





3-5020-40



3-5020-15

ITEM #	DIFFUSER	FINISH	DIMENSIONS	LAMPING	DRIVER	CERTIFICATION
3-5020-XX	Matte White Acrylic	15 Black 24 Satin Nickel 40 Aged Brass	6.25"(w) x 12.125"(h) x 3"(ext)	1 x 9w, 90CRI 3000k LED	120V Triac dimming	  

**GENERAL SPECIFICATIONS:**

- Cold rolled steel backplate and trim. • Acrylic shade is 1/8", matte white finish. • Unit mounts to deep 4" octagonal junction box or deep 4"x4" square junction box w/ single device mud ring. • Approved for vertical or horizontal mounting. • Unit requires 2.5" deep junction box. • Driver mounts inside junction box. • Total luminaire power 11.3w.
- Visit [www.oxygenlighting.com](http://www.oxygenlighting.com) for technical cut sheets. • Oxygen reserves the right to modify designs at any time.

# ZEEPERS SCONCE



ADA LED

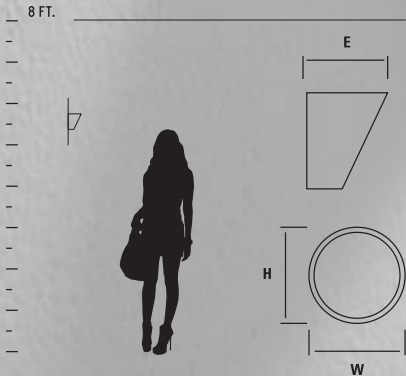

3-560-24





ITEM #	DIFFUSER	FINISH	DIMENSIONS	LAMPING	DRIVER	CERTIFICATION
<b>3-560-XX</b>	Matte White Acrylic	22 Oiled Bronze 24 Satin Nickel 40 Aged Brass	4.75"(w) x 4.75"(h) x 3.875"(ext)	1 x 8.2w, 90CRI 3000k LED	120/277V 0-10V/Phase dimming	  

2700k, 3500k, 4000k color temperatures also available. Visit [oxygenlighting.com](http://oxygenlighting.com)

**GENERAL SPECIFICATIONS:**

- Cold rolled steel backplate and trim.
- Acrylic shade is 1/8", matte white finish.
- Unit mounts to deep 4" octagonal or deep 2"x3" junction box.
- Driver mounts inside junction box.
- Unit requires 2.5" deep junction box.
- Approved for wall and ceiling mount applications.
- Total luminaire power 10.4w.
- Visit [www.oxygenlighting.com](http://www.oxygenlighting.com) for technical cut sheets.
- Oxygen reserves the right to modify designs at any time.



# ZENITH SCONCE

ADA

LED



3-556-24

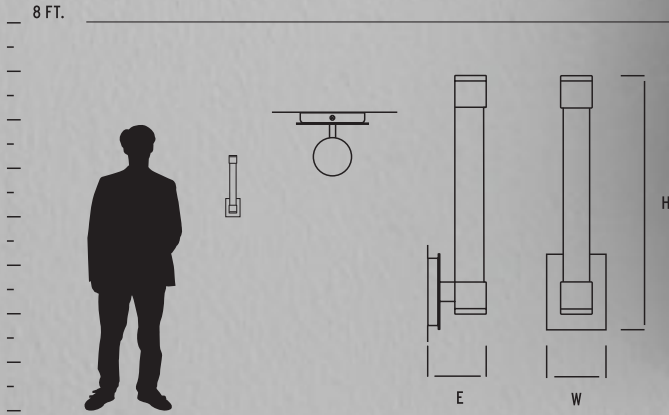





**3-556-14**  
Shown with Optional Cover Plate (Included)



**3-556-22**



**3-556-40**  
Shown with Optional Cover Plate (Included)

ITEM #	DIFFUSER	FINISH	DIMENSIONS	LAMPING	DRIVER	CERTIFICATION
<b>3-556-XX</b>	Matte White Acrylic	14 Polished Chrome 22 Oiled Bronze 24 Satin Nickel 40 Aged Brass	3.5"(w) x 15.125"(h) x 3.5"(ext)	1 x 12.2w, 90CRI 3000k LED	120V /277V 0-10V/Phase dimming	  

2700k, 3500k, 4000k color temperatures also available. Visit [oxygenlighting.com](http://oxygenlighting.com)

**GENERAL SPECIFICATIONS:**

- Cold rolled steel backplate and trim.
- Acrylic shade is 1/8", matte white finish.
- Unit mounts to deep 4" square junction box w/ single device mud ring or w/ optional cover plate deep 4" octagonal junction box.
- Approved for wall mount applications only.
- Unit requires 2.5" deep junction box.
- Driver mounts inside junction box.
- Total luminaire power 14.6w.
- Visit [www.oxygenlighting.com](http://www.oxygenlighting.com) for technical cut sheets.
- Oxygen reserves the right to modify designs at any time.

# ZETA SCONCE

ADA

LED



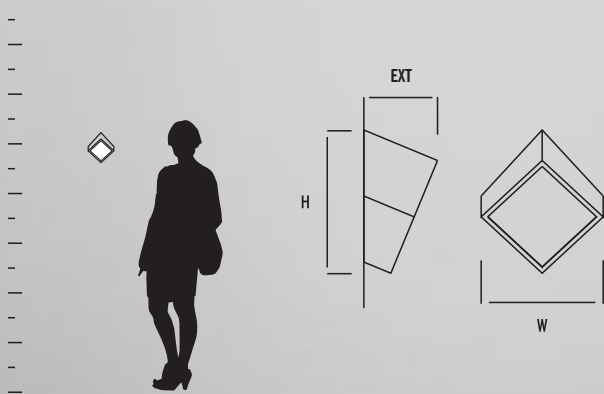

3-530-40

8 FT.





ITEM #	DIFFUSER	FINISH	DIMENSIONS	LAMPING	DRIVER	CERTIFICATION
3-530-XX	Matte White Acrylic	22 Oiled Bronze 24 Satin Nickel 40 Aged Brass	6.75"(w) x 7.75"(h) x 4"(ext)	1 x 8.2w, 90CRI 3000k LED	120/277V 0-10V/Phase dimming	  

2700k, 3500k, 4000k color temperatures also available. Visit [oxygenlighting.com](http://oxygenlighting.com)

**GENERAL SPECIFICATIONS:**

- Cold rolled steel backplate and trim.
- Acrylic shade is 1/8", matte white finish.
- Unit mounts to deep 4" octagonal or deep 2"x3" junction box.
- Driver mounts inside junction box.
- Unit requires 2.5" deep junction box.
- Approved for wall and ceiling mount applications.
- Total luminaire power 10.3w.
- Visit [www.oxygenlighting.com](http://www.oxygenlighting.com) for technical cut sheets.
- Oxygen reserves the right to modify designs at any time.



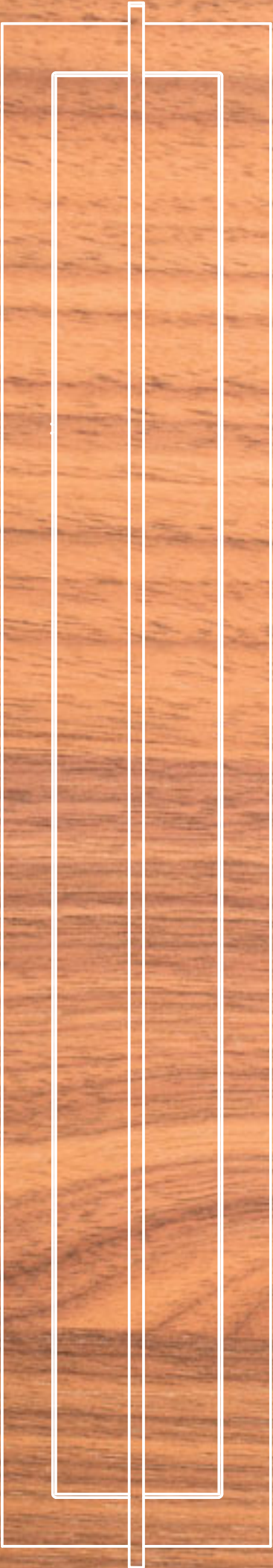



# VANITIES

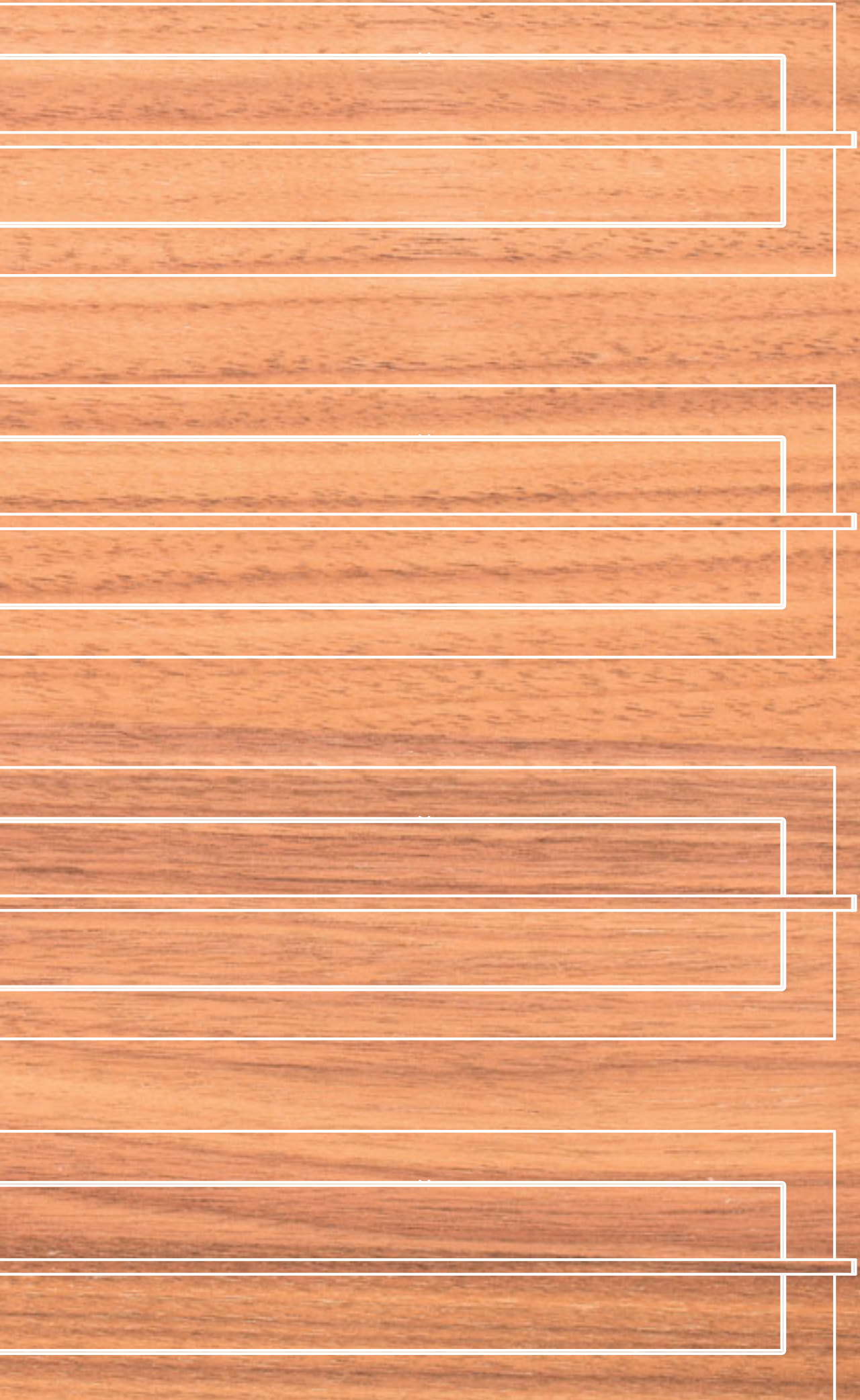



# ADAGIO VANITY

ADA

LED



3-571-20

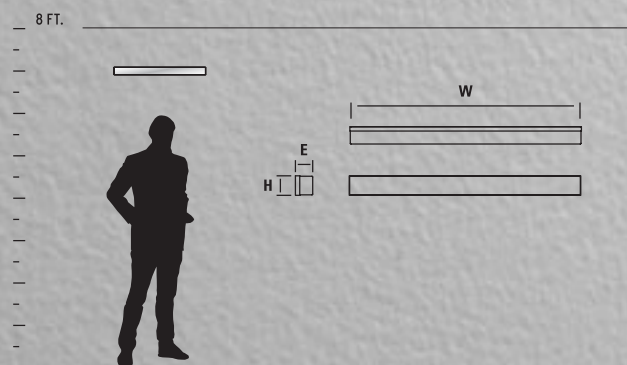





3-571-20



3-571-24

ITEM #	DIFFUSER	FINISH	DIMENSIONS	LAMPING	DRIVER	CERTIFICATION
3-571-XX	Matte White Acrylic	20 Polished Nickel 24 Satin Nickel	26.75"(w) x 2.25"(h) x 2"(ext)	1 x 11.9w, 90CRI 3000k LED	120/277V 0-10V/Phase dimming	  

2700k, 3500k, 4000k color temperatures also available. Visit [oxygenlighting.com](http://oxygenlighting.com)

**GENERAL SPECIFICATIONS:**

- Cold-rolled steel housing. • Diffuser is 1/8" thick matte white acrylic. • Unit mounts to deep 4" octagonal junction box, deep 4"x4" square junction box or a deep 4"x4" square junction box w/ single device mud ring. • Approved for wall mount applications only. • Unit requires 2.5" deep junction box. • Driver mounts inside junction box. • Total luminaire power 14.9w. • Visit [www.oxygenlighting.com](http://www.oxygenlighting.com) for technical cut sheets. • Oxygen reserves the right to modify designs at any time.

# ADELPHI VANITY

ADA

LED







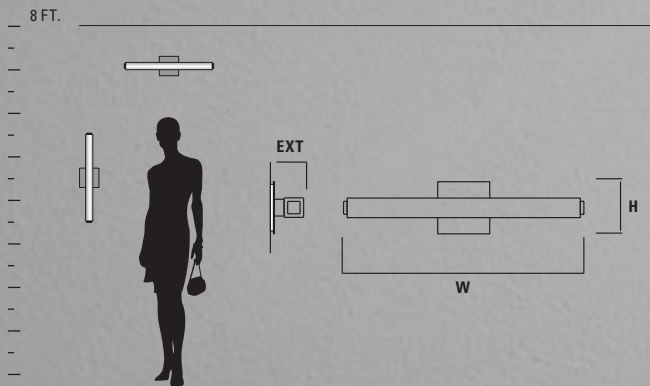





FLOURESCENT



2-5170-224





ITEM #	DIFFUSER	FINISH	DIMENSIONS	LAMPING	BALLAST	DRIVER	CERTIFICATION
2-5170-224	Matte White Acrylic	24 Satin Nickel	24.25" (w) x 5.25" (h) x 3.5" (ext)	1 x 14w T5 fluorescent (mini bi-pin)	Electronic, HPF, Programmed Start, Universal Voltage (120-277V)	--	   
3-536-XX	Matte White Acrylic	22 Oiled Bronze 24 Satin Nickel 40 Aged Brass	46.375" (w) x 4.75" (h) x 3.5" (ext)	2 x 11.6w, 90CRI 3000k LED	--	120/277V 0-10V/Phase dimming.	   
3-537-XX	Matte White Acrylic	22 Oiled Bronze 24 Satin Nickel 40 Aged Brass	24.25" (w) x 5.25" (h) x 3.5" (ext)	1 x 11.6w, 90CRI 3000k LED	--	120/277V 0-10V/Phase dimming.	   

2700k, 3500k, 4000k color temperatures also available for LED models. Visit [oxygenlighting.com](http://oxygenlighting.com)

**GENERAL SPECIFICATIONS:**

- Cold rolled steel housing. • Diffuser is 1/8" thick matte white acrylic. • Installs on 4" octagonal junction box. • Toolless access to lamp for fluorescent model. • Approved for vertical or horizontal mounting. • Approved for wall mount application only. • Total luminaire power 29.6w for 3-536-XX and 15w for 3-537-XX. • Visit [www.oxygenlighting.com](http://www.oxygenlighting.com) for technical cut sheets. • Oxygen reserves the right to modify designs at any time.

# ALCOR VANITY

ADA

LED



3-533-22

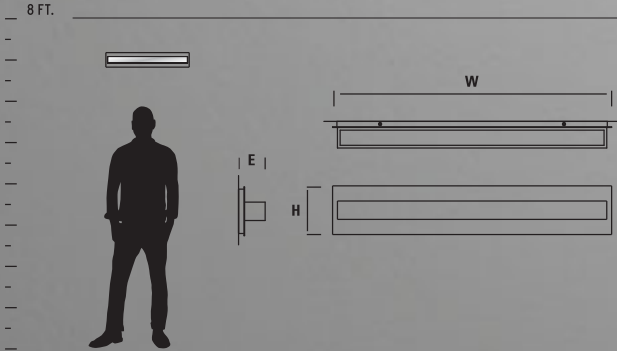





3-533-22



3-533-24

ITEM #	DIFFUSER	FINISH	DIMENSIONS	LAMPING	DRIVER	CERTIFICATION
3-533-XX	Matte White Acrylic	22 Oiled Bronze 24 Satin Nickel	26"(w) x 4.5"(h) x 2.5"(ext)	1 x 11.6w, 90CRI 3000k LED	120V/277V 0-10V/Phase dimming	  

2700k, 3500k, 4000k color temperatures also available. Visit [oxygenlighting.com](http://oxygenlighting.com)

**GENERAL SPECIFICATIONS:**

- Cold rolled steel housing. • 1/8" thick matte white acrylic. • Unit mounts to deep 4" octagonal junction box or deep 4"x4" square junction box w/ round mud ring mounting holes 2.75" on center. • Approved for vertical or horizontal mounting. • Approved for wall mount application only. • Unit requires 2.5" deep junction box. • Driver mounts inside junction box. • Total luminaire power 14.2w. • Visit [www.oxygenlighting.com](http://www.oxygenlighting.com) for technical cut sheets. • Oxygen reserves the right to modify designs at any time.



# APOLLO VANITY

ADA

FLOURESCENT



2-5105-24 & 2-5106-24

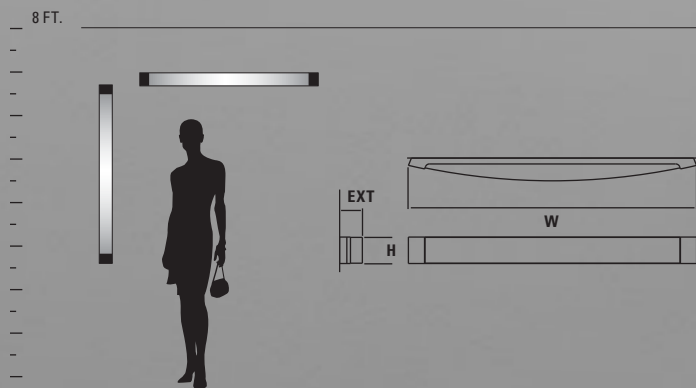















2-5104-24



2-5105-14

ITEM #	DIFFUSER	FINISH	DIMENSIONS	LAMPING	BALLAST	CERTIFICATION
<b>2-5104-XX</b> small	Matte White Acrylic	14 Polished Chrome 24 Satin Nickel	25.25"(w) x 4.75"(h) x 3"(ext)	2 x 14w T5 linear fluorescent (mini bi-pin)	Electronic HPF, Rapid Start, Universal Voltage (120-277V)	   
<b>2-5105-XX</b> medium	Matte White Acrylic	14 Polished Chrome 24 Satin Nickel	37.25"(w) x 4.75"(h) x 3.75"(ext)	2 x 21w T5 linear fluorescent (mini bi-pin)	Electronic HPF, Rapid Start, Universal Voltage (120-277V)	   
<b>2-5106-XX</b> large	Matte White Acrylic	14 Polished Chrome 24 Satin Nickel	49"(w) x 4.75"(h) x 4"(ext)	2 x 28w T5 linear fluorescent (mini bi-pin)	Electronic HPF, Programmed Start, Universal Voltage (120-277V)	   

**GENERAL SPECIFICATIONS:**

- Cold-rolled steel housing. • Diffusers are 1/8" thick matte white acrylic. • Installs to 4" octagonal junction box. • Toolless access to lamps. • Approved for vertical or horizontal mounting. • Approved for wall applications only. • Visit [www.oxygenlighting.com](http://www.oxygenlighting.com) for technical cut sheets. • Oxygen reserves the right to modify designs at any time.

# APOLLO VANITY

ADA







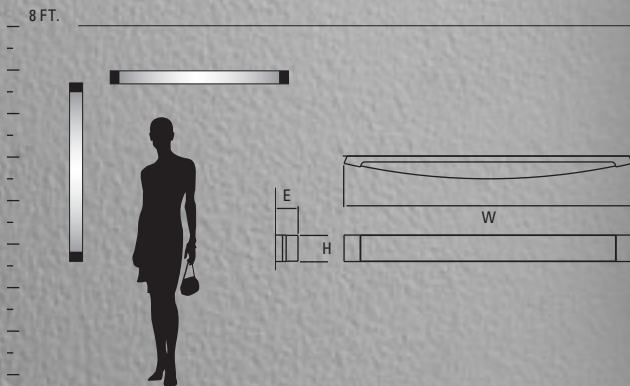

LED



3-525-22





ITEM #	DIFFUSER	FINISH	DIMENSIONS	LAMPING	DRIVER	CERTIFICATION
<b>3-524-XX</b> small	Matte White Acrylic	14 Polished Chrome 22 Oiled Bronze 24 Satin Nickel	27.75"(w) x 2.75"(h) x 2.5"(ext)	2 x 10.1w, 90CRI 3000k LED	120/277V 0-10V/Phase dimming	  
<b>3-525-XX</b> medium	Matte White Acrylic	14 Polished Chrome 22 Oiled Bronze 24 Satin Nickel	31.75"(w) x 2.75"(h) x 2.5"(ext)	2 x 10.1w, 90CRI 3000k LED	120/277V 0-10V/Phase dimming	  
<b>3-526-XX</b> large	Matte White Acrylic	14 Polished Chrome 22 Oiled Bronze 24 Satin Nickel	54"(w) x 2.75"(h) x 2.5"(ext)	2 x 11.6w, 90CRI 3000k LED	120/277V 0-10V/Phase dimming	  

2700k, 3500k, 4000k color temperatures also available. Visit [oxygenlighting.com](http://oxygenlighting.com)

**GENERAL SPECIFICATIONS:**

- Cold rolled steel housing and trim. • Diffusers are 1/8" thick matte white acrylic. • Unit mounts to a deep 4"x4" junction box w/ single device mud ring. • Approved for horizontal or vertical mounting. • Approved for wall mount applications only. • Unit requires 2.5" deep junction box. • Driver mounts inside junction box. • Total luminaire power 26.1w for 3-524-XX, 25.9w for 3-525-XX, and 29.6w for 3-526-XX. • Visit [www.oxygenlighting.com](http://www.oxygenlighting.com) for technical cut sheets. • Oxygen reserves the right to modify designs at any time.

# ARCHER VANITY

ADA

LED



3-575-24

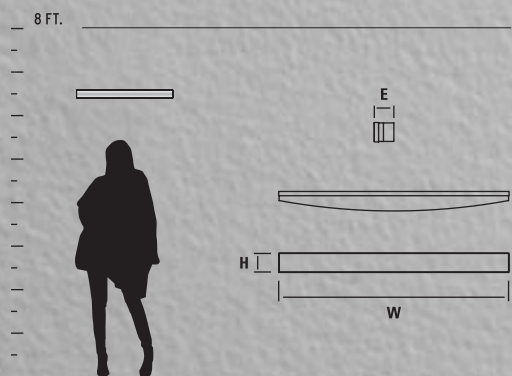







3-575-20



3-575-24

ITEM #	DIFFUSER	FINISH	DIMENSIONS	LAMPING	DRIVER	CERTIFICATION
3-575-XX	Matte White Acrylic	20 Polished Nickel 24 Satin Nickel	26.75"(w) x 2.25"(h) x 2.5"(ext)	1 x 11.9w, 90CRI 3000k LED	120/277V 0-10V/Phase dimming	  

2700k, 3500k, 4000k color temperatures also available. Visit [oxygenlighting.com](http://oxygenlighting.com)

**GENERAL SPECIFICATIONS:**

- Cold-rolled steel housing.
- Diffuser is 1/8" thick matte white acrylic.
- Unit mounts to horizontal deep 2"x3" junction box or a deep 4"x4" junction box w/ a single device mud ring.
- Approved for wall mount application only.
- Approved for vertical or horizontal mounting.
- Unit requires 2.5" deep junction box.
- Driver mounts inside junction box.
- Total luminaire power 14.6w.
- Visit [www.oxygenlighting.com](http://www.oxygenlighting.com) for technical cut sheets.
- Oxygen reserves the right to modify designs at any time.



# AXEL VANITY

ADA

LED



3-552-20

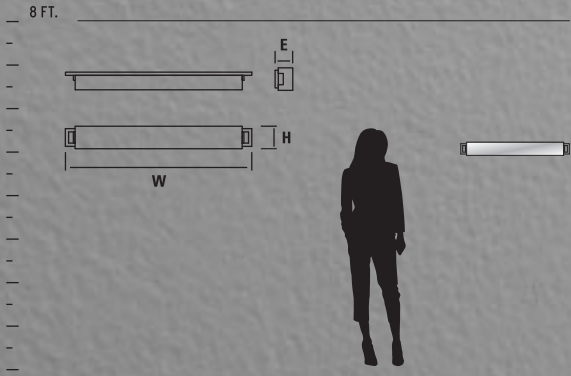



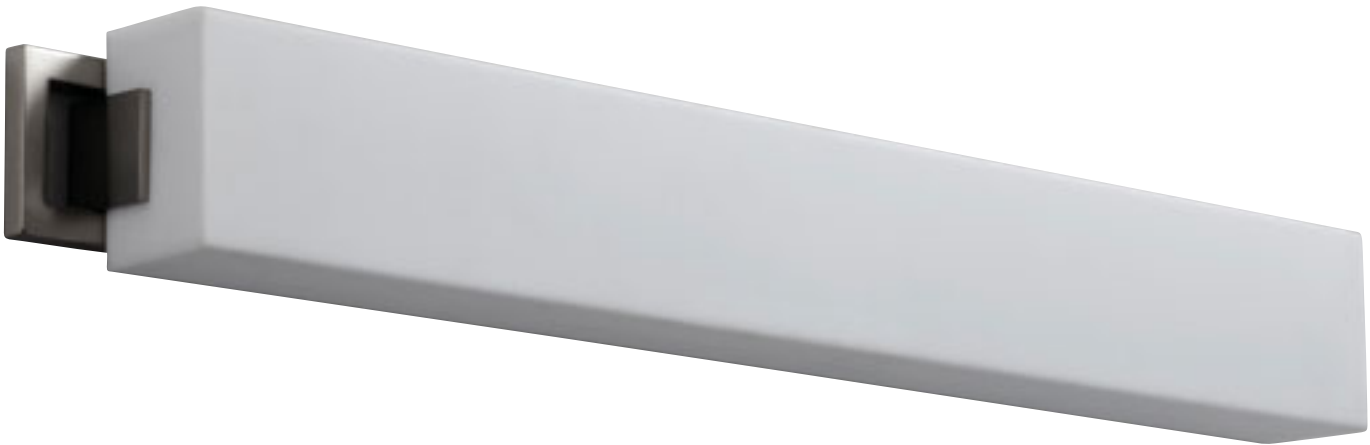

3-552-20



3-552-24

ITEM #	DIFFUSER	FINISH	DIMENSIONS	LAMPING	DRIVER	CERTIFICATION
3-552-XX	Matte White Acrylic	20 Polished Nickel 24 Satin Nickel	29"(w) x 3.5"(h) x 2.75"(ext)	1 x 11.9w, 90CRI 3000k LED	120/277V 0-10V/Phase dimming	  

2700k, 3500k, 4000k color temperatures also available. Visit [oxygenlighting.com](http://oxygenlighting.com)

**GENERAL SPECIFICATIONS:**

- Cold-rolled steel housing. • Diffuser is 1/8" thick matte white acrylic. • Unit mounts to a deep 4"x4" square junction box w/ a single device mud ring. • Approved for wall mount application only. • Approved for vertical or horizontal mounting. • Unit requires 2.5" deep junction box. • Driver mounts inside junction box. • Total luminaire power 14.5w.
- Visit [www.oxygenlighting.com](http://www.oxygenlighting.com) for technical cut sheets. • Oxygen reserves the right to modify designs at any time.

# BALANCE VANITY

ADA

LED



3-547-20-BP220

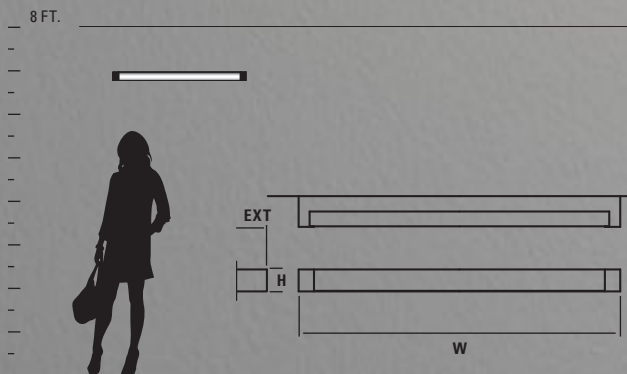



3-547-20



3-549-BP424



3-549-24

ITEM #	DIFFUSER	FINISH	DIMENSIONS	LAMPING	DRIVER	CERTIFICATION
<b>3-547-XX</b> small	Matte White Acrylic	20 Polished Nickel 24 Satin Nickel	24.75"(w) x 2.5"(h) x 3.5"(ext)	1 x 11.9w, 90CRI 3000k LED	120/277V 0-10V/Phase dimming	ADA COMPLIANT, ETL US, ETL damp
<b>3-547-XX-BP2XX</b> small w/ backplate	Matte White Acrylic	20 Polished Nickel 24 Satin Nickel	29"(w) x 4.5"(h) x 4"(ext)	1 x 11.9w, 90CRI 3000k LED	120/277V 0-10V/Phase dimming	ADA COMPLIANT, ETL US, ETL damp
<b>3-549-XX</b> large	Matte White Acrylic	20 Polished Nickel 24 Satin Nickel	48.5"(w) x 2.5"(h) x 3.5"(ext)	2 x 11.9w, 90CRI 3000k LED	120/277V 0-10V/Phase dimming	ADA COMPLIANT, ETL US, ETL damp
<b>3-549-XX-BP4XX</b> large w/ backplate	Matte White Acrylic	20 Polished Nickel 24 Satin Nickel	52.75"(w) x 4.5"(h) x 4"(ext)	2 x 11.9w, 90CRI 3000k LED	120/277V 0-10V/Phase dimming	ADA COMPLIANT, ETL US, ETL damp

2700k, 3500k, 4000k color temperatures also available. Visit [oxygenlighting.com](http://oxygenlighting.com)

**GENERAL SPECIFICATIONS:**

• Cold rolled steel housing. • Diffusers are 1/8" thick matte white acrylic. • All units mount to deep 4"x4" square junction box w/ a single device mud ring or deep 4" octagonal junction box with optional accessory backplate. • Approved for horizontal mounting only. • Approved for wall mount application only. • Unit requires 2.5" deep junction box. • Driver mounts inside junction box. • Total luminaire power 14.5w for 3-547-XX and 28.6w for 3-549-XX. • Visit [www.oxygenlighting.com](http://www.oxygenlighting.com) for technical cut sheets. • Oxygen reserves the right to modify designs at any time.

# CRESCENT VANITY

ADA



LED

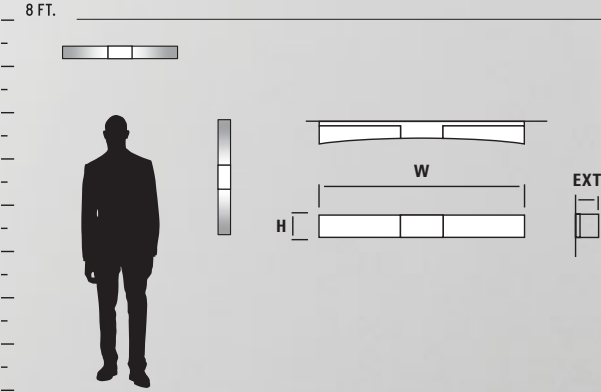

3-582-24

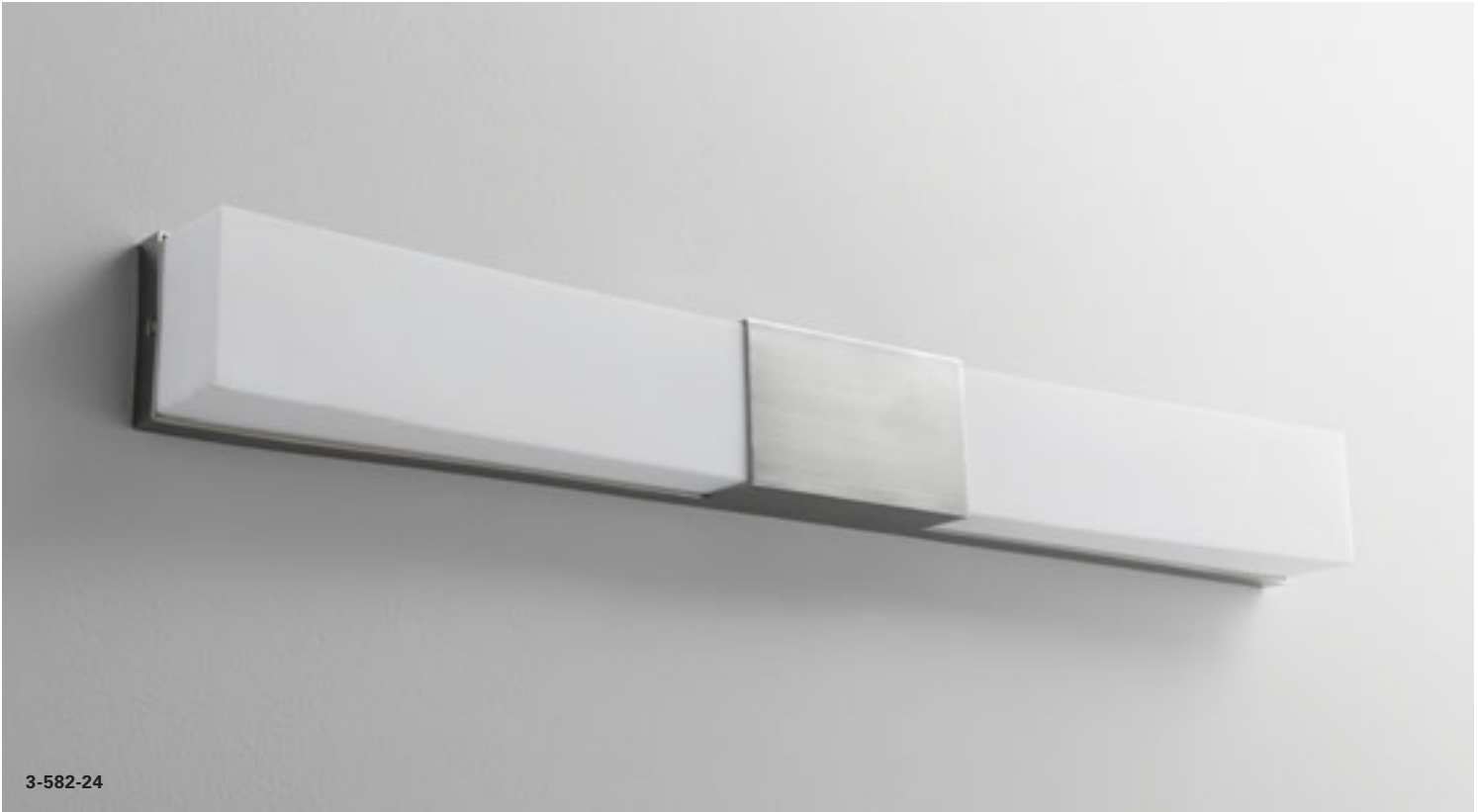



ITEM #	DIFFUSER	FINISH	DIMENSIONS	LAMPING	DRIVER	CERTIFICATION
3-582-24	Matte White Acrylic	24 Satin Nickel	30.5"(w) x 3.5"(h) x 3"(ext)	2 x 10.1w, 90CRI 3000k LED	120/277V 0-10V/Phase dimming	  

2700k, 3500k, 4000k color temperatures also available. Visit [oxygenlighting.com](http://oxygenlighting.com)

**GENERAL SPECIFICATIONS:**

- Cold rolled steel housing and trim.
- Diffusers are 1/8" thick matte white acrylic.
- Unit mounts to deep 2"x3" junction box or deep 4"x4" square junction box w/ a single device mud ring.
- Approved for horizontal or vertical mounting.
- Approved for wall mount applications only.
- Total luminaire power 25.7w.
- Visit [www.oxygenlighting.com](http://www.oxygenlighting.com) for technical cut sheets.
- Oxygen reserves the right to modify designs at any time.



# FUGIT VANITY

ADA

LED



3-5012-20

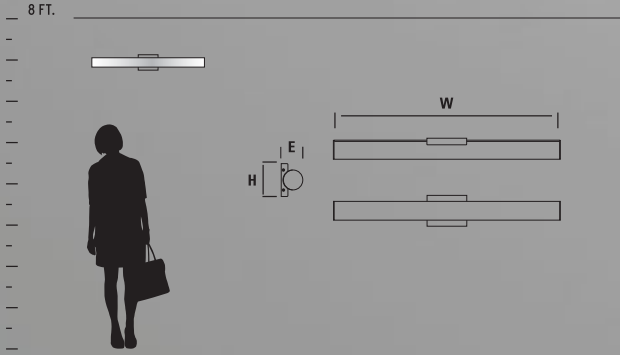



3-5011-15



3-5012-20



3-5013-24

ITEM #	DIFFUSER	FINISH	DIMENSIONS	LAMPING	DRIVER	CERTIFICATION
3-5011-XX small	Matte White Acrylic	15 Black 20 Polished Nickel 24 Satin Nickel	17.625"(w) x 4.5"(h) x 3.125"(ext)	1 x 13w, 90CRI 3000k LED	120V Triac dimming	ADA ETL
3-5012-XX medium	Matte White Acrylic	15 Black 20 Polished Nickel 24 Satin Nickel	23.25"(w) x 4.5"(h) x 3.125"(ext)	2 x 9w, 90CRI 3000k LED	120V Triac dimming	ADA ETL
3-5013-XX large	Matte White Acrylic	15 Black 20 Polished Nickel 24 Satin Nickel	34.25"(w) x 4.5"(h) x 3.125"(ext)	2 x 13w, 90CRI 3000k LED	120V Triac dimming	ADA ETL

**GENERAL SPECIFICATIONS:**

• Cold rolled steel housing. • Cast steel end caps. • 1/8" thick matte white acrylic. • Unit mounts to deep 4" octagonal junction box or deep 4"x4" square junction box w/ single device mud ring. • Approved for vertical or horizontal mounting. • Approved for wall mount application only. • Unit requires 2.5" deep junction box. • Driver mounts inside junction box. • Total luminaire power for 3-5011 is 15.5w, 3-5012 is 23.0w & 3-5013 is 32.9w. • Visit [www.oxygenlighting.com](http://www.oxygenlighting.com) for technical cut sheets. • Oxygen reserves the right to modify designs at any time.

# FUSE VANITY

ADA

LED





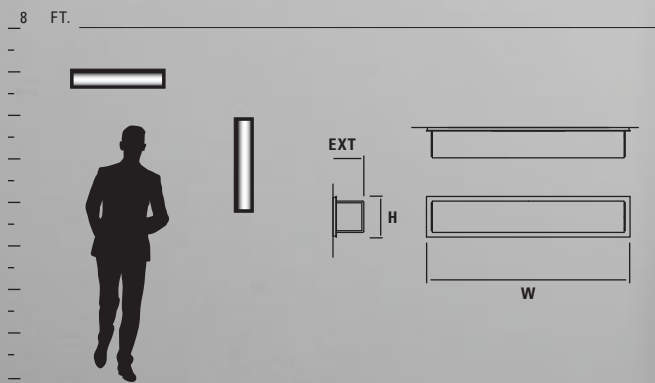

FLOURESCENT



3-544-24





ITEM #	DIFFUSER	FINISH	DIMENSIONS	LAMPING	BALLAST	DRIVER	CERTIFICATION
<b>2-5134-24</b>	Matte White Acrylic	24 Satin Nickel	26"(w) x 5"(h) x 4"(ext)	2 x 17w T8 fluorescent (medium bi-pin)	Electronic, HPF, Instant Start, Universal Voltage (120V-277V)	--	  
<b>3-544-24</b>	Matte White Acrylic	24 Satin Nickel	26"(w) x 5"(h) x 4"(ext)	2 x 10.1w, 90CRI 3000k LED	--	120/277V 0-10V/Phase dimming	  

2700k, 3500k, 4000k color temperatures also available for LED models. Visit [oxygenlighting.com](http://oxygenlighting.com)

**GENERAL SPECIFICATIONS:**

- Cold rolled steel housing. • Machined steel end caps. • Acrylic diffusers are formed, 1/8" thick matte white acrylic. • Unit mounts to 4" octagonal junction box, with additional holes provided to mount direct to structure. • Approved for wall mount application only. • Toolless access to lamps for fluorescent model. • Approved for vertical or horizontal mounting. • Unit requires 2.5" deep junction box. • Driver mounts inside junction box. • Total luminaire power 26.2w for LED models. • Visit [www.oxygenlighting.com](http://www.oxygenlighting.com) for technical cut sheets. • Oxygen reserves the right to modify designs at any time.

# HORIZON VANITY



LED

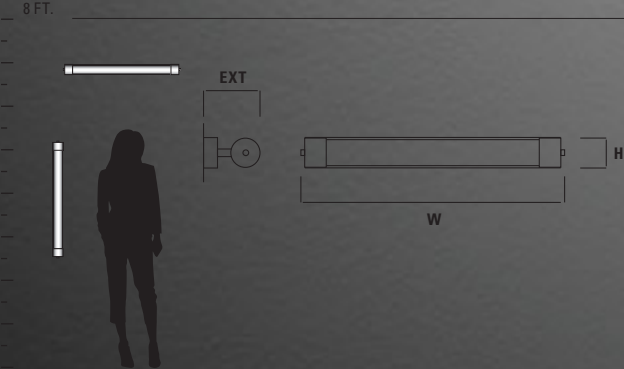

3-593-24





ITEM #	DIFFUSER	FINISH	DIMENSIONS	LAMPING	DRIVER	CERTIFICATION
3-593-XX	Matte White Acrylic	14 Polished Chrome 24 Satin Nickel	26"(w) x 3"(h) x 5.75"(ext)	1 x 11.6w, 90CRI 3000k LED	120/277V 0-10V/Phase dimming	 

2700k, 3500k, 4000k color temperatures also available. Visit [oxygenlighting.com](http://oxygenlighting.com)

**GENERAL SPECIFICATIONS:**

- Cold rolled steel housing and trim.
- Diffusers are 1/8" thick matte white acrylic.
- Unit mounts to deep 2"x3" junction box or deep 4"x4" square junction box w/ a single device mud ring with additional mounting points direct to structure.
- Allow 6" to either end of fixture to facilitate mounting of back plate.
- Approved for horizontal or vertical mounting.
- Approved for wall mount applications only.
- Total luminaire power 30.8w.
- Visit [www.oxygenlighting.com](http://www.oxygenlighting.com) for technical cut sheets.
- Oxygen reserves the right to modify designs at any time.



# MAGNETA VANITY

ADA

LED



3-590-24

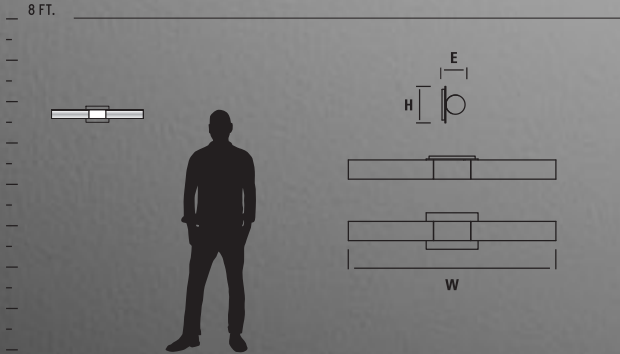

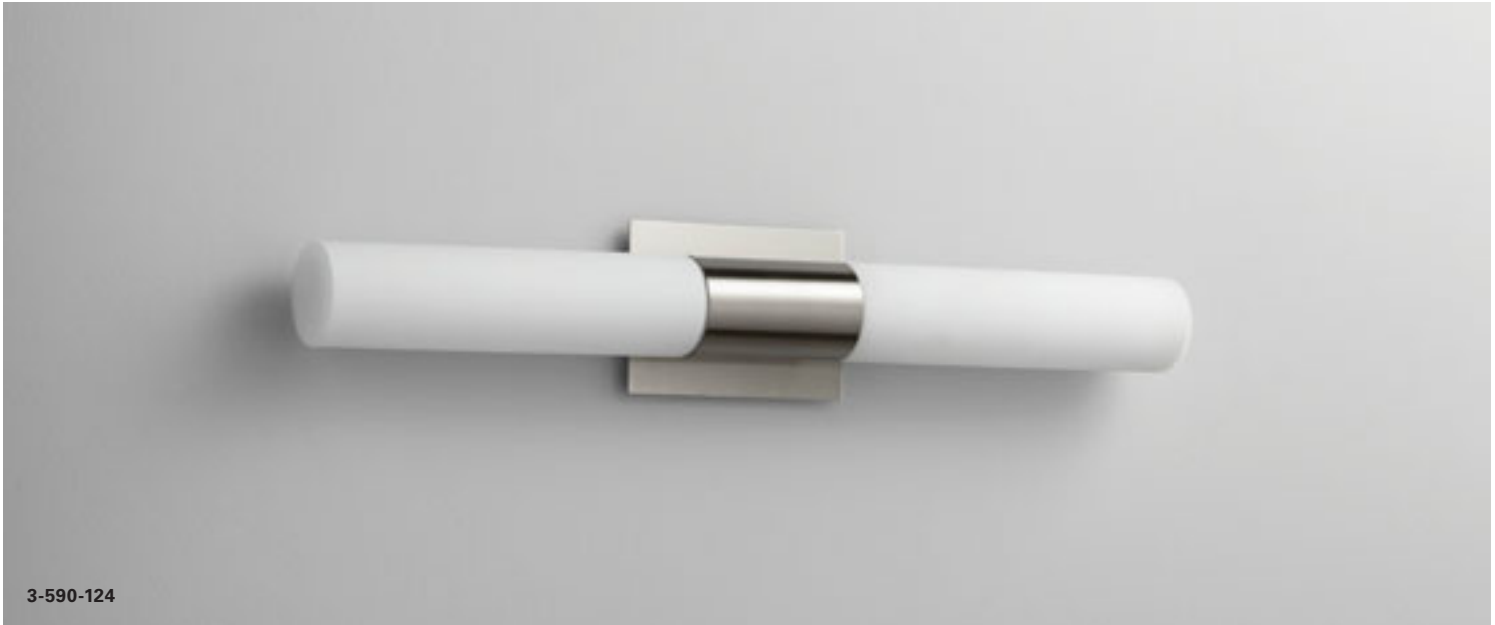



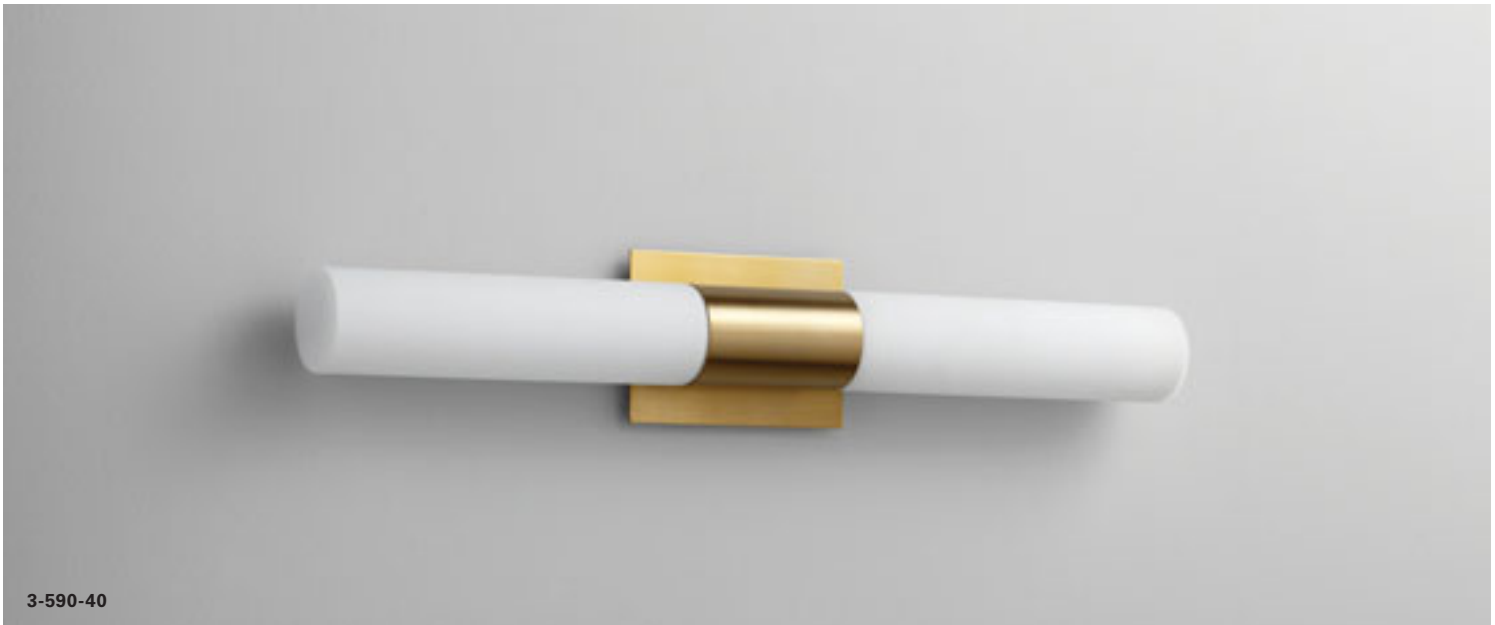



3-590-124



3-590-40

ITEM #	DIFFUSER	FINISH	DIMENSIONS	LAMPING	DRIVER	CERTIFICATION
<b>3-590-XX</b>	Matte White Acrylic	24 Satin Nickel 40 Aged Brass	27"(w) x 4.75"(h) x 3.375"(ext)	2 x 11.9w, 90CRI 3000k LED	120/277V 0-10V/Phase dimming	  
<b>3-590-1XX</b>	1 Matte Opal Glass	24 Satin Nickel 40 Aged Brass	27"(w) x 4.75"(h) x 3.375"(ext)	2 x 11.9w, 90CRI 3000k LED	120/277V 0-10V/Phase dimming	  

2700k, 3500k, 4000k color temperatures also available. Visit [oxygenlighting.com](http://oxygenlighting.com)

**GENERAL SPECIFICATIONS:**

• Aluminum housing. • Diffuser is 1/8" thick matte white acrylic or matte opal glass. • Unit mounts to deep 4" octagonal junction box, deep 4"x4" square junction box or a deep 4"x4" square junction box w/ single device mud ring. • Approved for wall mount application only. • Closed ends. • Approved for vertical or horizontal mounting. • Unit requires 2.5" deep junction box. • Driver mounts inside junction box. • Total luminaire power 29w. • Visit [www.oxygenlighting.com](http://www.oxygenlighting.com) for technical cut sheets. • Oxygen reserves the right to modify designs at any time.

# MAGNUM VANITY

ADA

LED



3-588-140

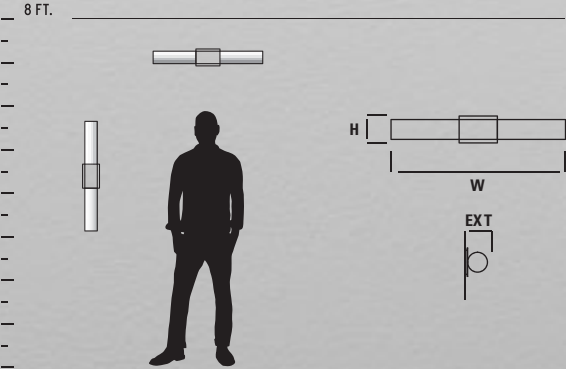

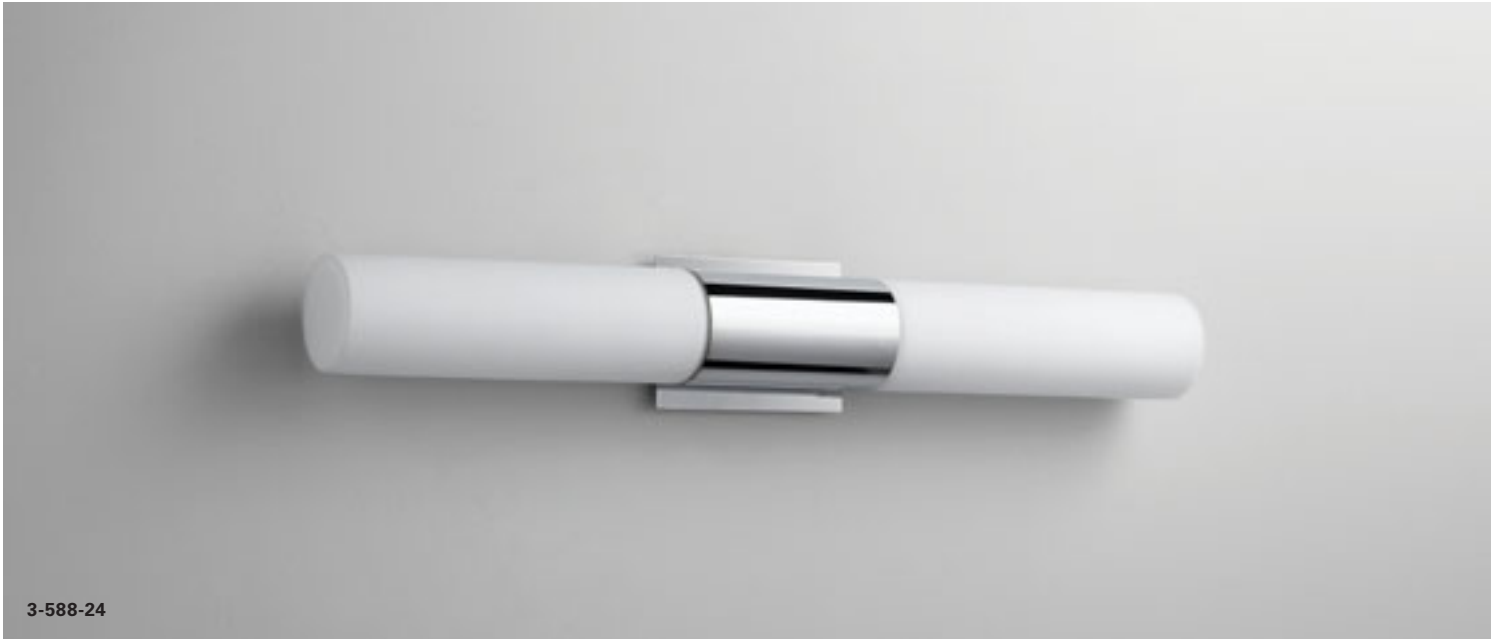







3-588-24



3-588-24



3-588-40

ITEM #	DIFFUSER	FINISH	DIMENSIONS	LAMPING	DRIVER	CERTIFICATION
<b>3-588-XX</b>	Matte White Acrylic	24 Satin Nickel 40 Aged Brass	30.75"(w) x 4.75"(h) x 4"(ext)	2 x 11.9w, 90CRI 3000k LED	120/277V 0-10V/Phase dimming available	  
<b>3-588-1XX</b>	<b>1</b> Matte Opal Glass	24 Satin Nickel 40 Aged Brass	30.75"(w) x 4.75"(h) x 4"(ext)	2 x 11.9w, 90CRI 3000k LED	120/277V 0-10V/Phase dimming available	  

2700k, 3500k, 4000k color temperatures also available. Visit [oxygenlighting.com](http://oxygenlighting.com)

**GENERAL SPECIFICATIONS:**

- Aluminum housing.
- Diffuser is 1/8" thick matte white acrylic or matte opal glass.
- Installs on 4" octagonal junction box.
- Approved for wall mount application only.
- Closed ends.
- Approved for vertical or horizontal mounting.
- Total luminaire power 30.5w.
- Visit [www.oxygenlighting.com](http://www.oxygenlighting.com) for technical cut sheets.
- Oxygen reserves the right to modify designs at any time.

# METRIX VANITY

ADA

LED

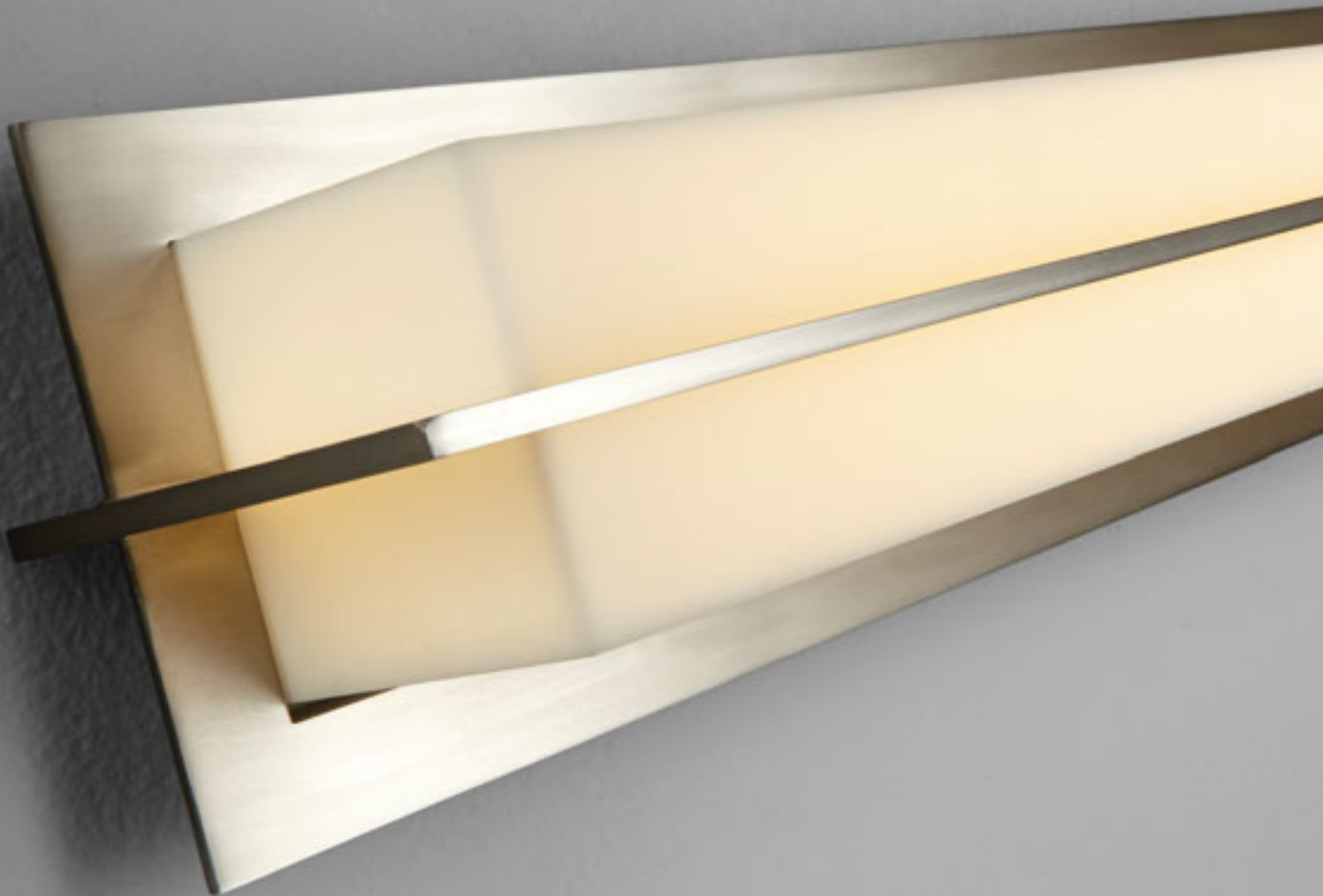

3-542-24

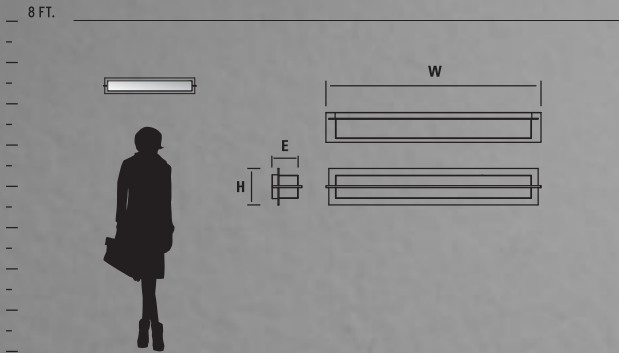





3-542-20



3-542-20

ITEM #	DIFFUSER	FINISH	DIMENSIONS	LAMPING	DRIVER	CERTIFICATION
3-542-XX	Matte White Acrylic	20 Polished Nickel 24 Satin Nickel	28"(w) x 4.75"(h) x 3.875"(ext)	1 x 11.9w, 90CRI 3000k LED	120/277V 0-10V/Phase dimming	  

2700k, 3500k, 4000k color temperatures also available. Visit [oxygenlighting.com](http://oxygenlighting.com)

**GENERAL SPECIFICATIONS:**

- Cold-rolled steel housing. • Diffuser is 1/8" thick matte white acrylic. • Unit mounts to deep 2"x3" junction box or deep 4"x4" square junction box w/ a single device mud ring.
- Approved for vertical or horizontal mounting. • Approved for wall or ceiling mount applications • Total luminaire power 14.6w. • Visit [www.oxygenlighting.com](http://www.oxygenlighting.com) for technical cut sheets. • Oxygen reserves the right to modify designs at any time.



# ORION VANITY

ADA

LED

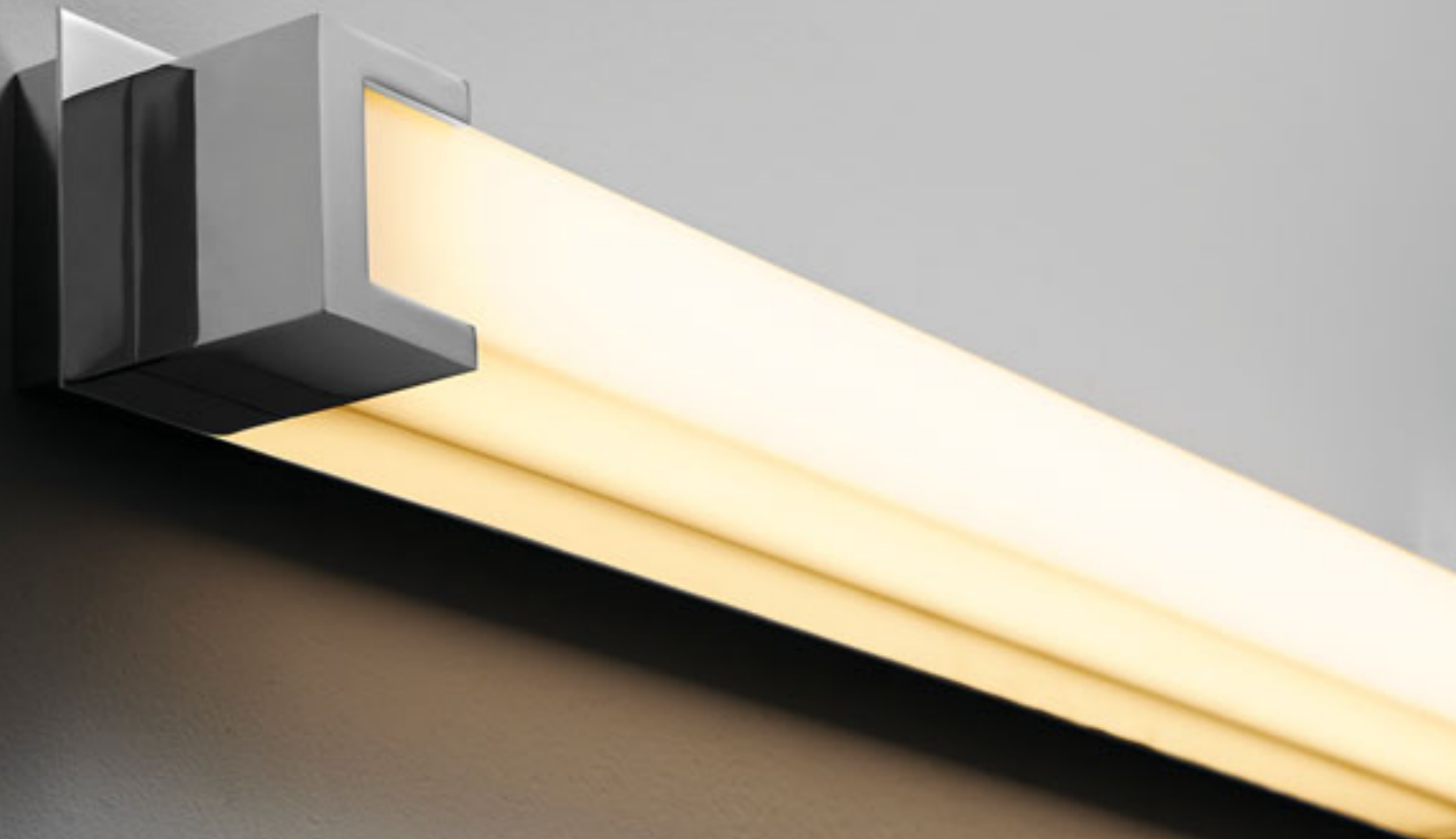

3-543-14

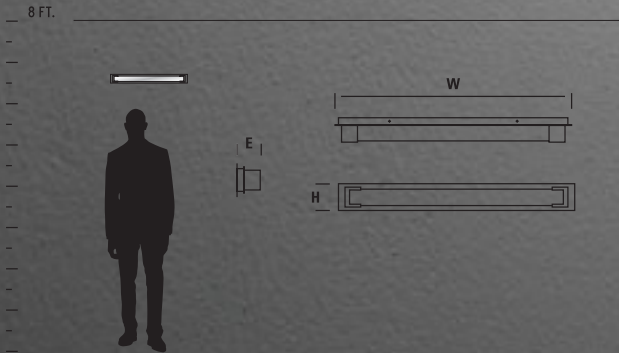





3-543-14



3-543-24

ITEM #	DIFFUSER	FINISH	DIMENSIONS	LAMPING	DRIVER	CERTIFICATION
3-543-XX	Matte White Acrylic	14 Polished Chrome 24 Satin Nickel	27"(w) x 3"(h) x 2.75"(ext)	1 x 11.6w, 90CRI 3000k LED	120V/277V 0-10V/Phase dimming	  

2700k, 3500k, 4000k color temperatures also available. Visit [oxygenlighting.com](http://oxygenlighting.com)

**GENERAL SPECIFICATIONS:**

- Cold rolled steel housing. • 1/8" thick matte white acrylic. • Unit mounts to deep 4"x4" square junction box w/ single device mud ring. • Approved for vertical or horizontal mounting. • Approved for wall mount application only. • Unit requires 2.5" deep junction box. • Driver mounts inside junction box. • Total luminaire power 14.2w.
- Visit [www.oxygenlighting.com](http://www.oxygenlighting.com) for technical cut sheets. • Oxygen reserves the right to modify designs at any time.

# PEBBLE VANITY

ADA



INCANDESCENT

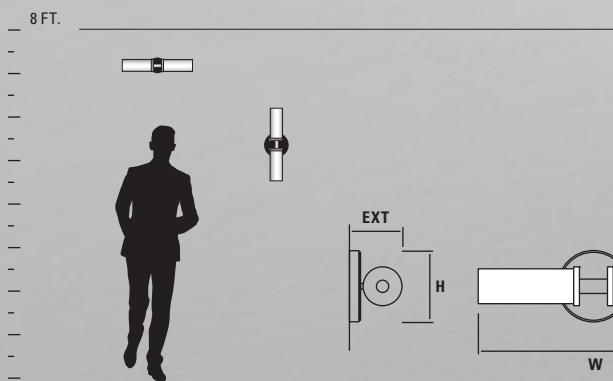

2-5121-124

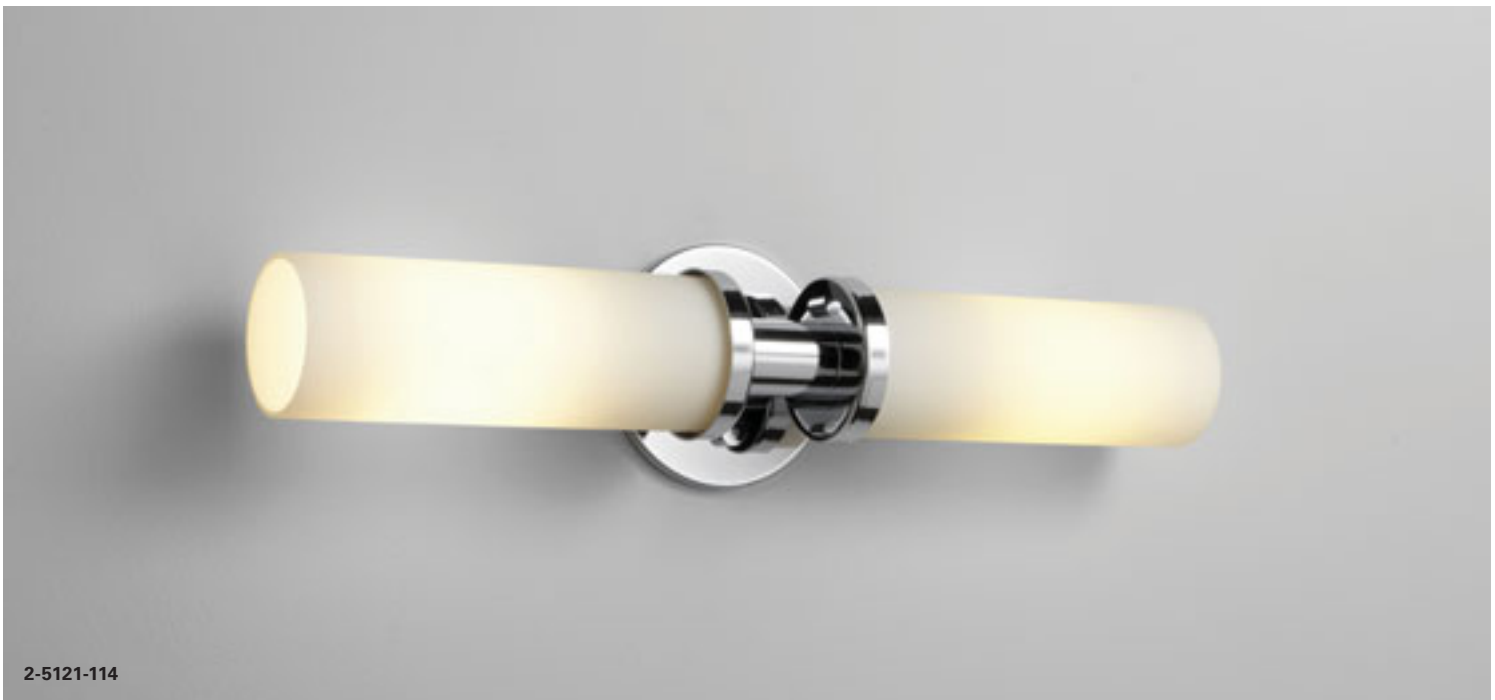
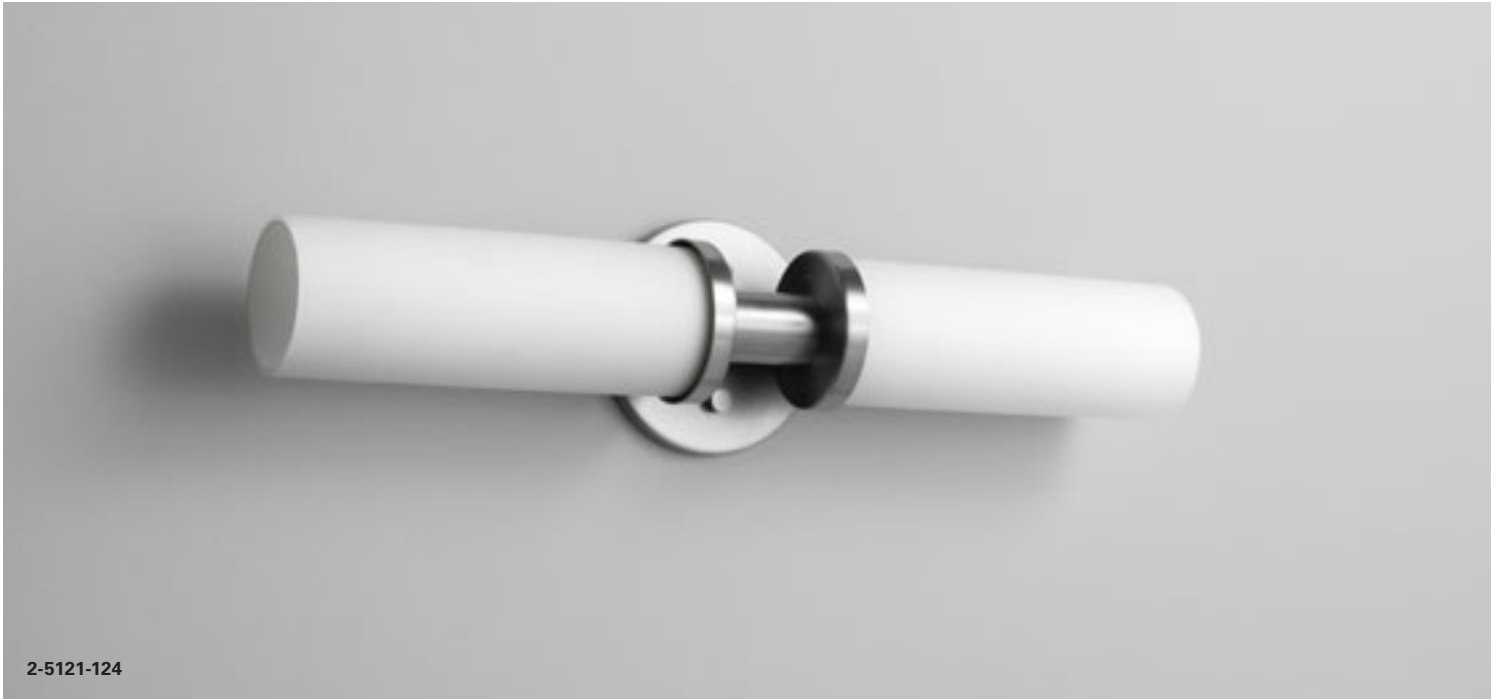



ITEM #	DIFFUSER	FINISH	DIMENSIONS	LAMPING	CERTIFICATION
2-5121-1XX	1 White Opal Glass	14 Polished Chrome 24 Satin Nickel	20.5"(w) x 4.25"(h) x 4"(ext)	2 x 60w T10 120V incandescent (medium base)	  

**GENERAL SPECIFICATIONS:**

- Cast and machined steel fittings. • Diffusers thread onto housing with integral threaded fitting. • Diffusers are 1/4" thick white opal duplex glass. • Unit mounts to 4" octagonal junction box. • Approved for wall mount application only. • Approved for vertical or horizontal mounting. • Open ends. • Visit [www.oxygenlighting.com](http://www.oxygenlighting.com) for technical cut sheets. • Oxygen reserves the right to modify designs at any time.

# PLATO VANITY

ADA

LED



3-534-24

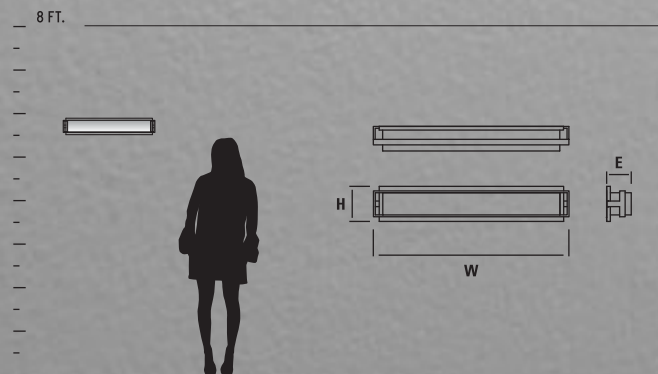





3-534-20



3-534-24

ITEM #	DIFFUSER	FINISH	DIMENSIONS	LAMPING	DRIVER	CERTIFICATION
3-534-XX	Matte White Acrylic	20 Polished Nickel 24 Satin Nickel	26.5"(w) x 4.75"(h) x 3.375"(ext)	1 x 11.6w, 90CRI 3000k LED	120/277V 0-10V/Phase dimming	  

2700k, 3500k, 4000k color temperatures also available. Visit [www.oxygenlighting.com](http://www.oxygenlighting.com)

**GENERAL SPECIFICATIONS:**

- Cold-rolled steel housing.
- Diffuser is 1/8" thick matte white acrylic.
- Unit mounts to deep 4" octagonal junction box, deep 4"x4" square junction box or a deep 4"x4" square junction box w/ single device mud ring.
- Approved for vertical or horizontal mounting.
- Approved for wall mount application only.
- Unit requires 2.5" deep junction box.
- Driver mounts inside junction box.
- Total luminaire power 14.9w.
- Visit [www.oxygenlighting.com](http://www.oxygenlighting.com) for technical cut sheets.
- Oxygen reserves the right to modify designs at any time.



# SKYLINE VANITY

ADA

FLOURESCENT



8 FT.

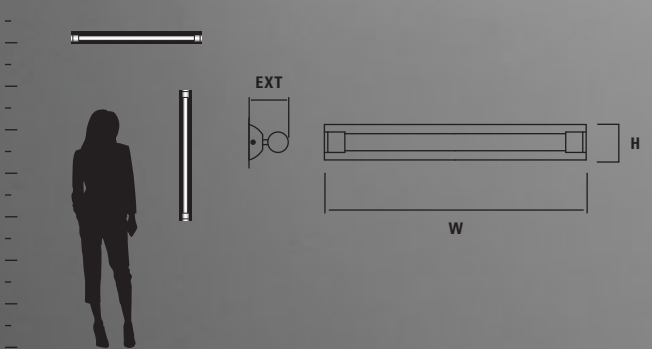









2-5131-24



2-5132-14

ITEM #	DIFFUSER	FINISH	DIMENSIONS	LAMPING	BALLAST	CERTIFICATION
2-5131-XX small	Matte White Acrylic	14 Polished Chrome 24 Satin Nickel	24"(w) x 3.25"(h) x 4"(ext)	1 x 14w T5 fluorescent (mini bi-pin)	Electronic, HPF, Programmed Start, Universal Voltage (120V - 277V)	  
2-5132-XX medium	Matte White Acrylic	14 Polished Chrome 24 Satin Nickel	36"(w) x 3.25"(h) x 4"(ext)	1 x 21w T5 fluores- cent (mini bi-pin)	Electronic, HPF, Programmed Start, Universal Voltage (120V - 277V)	  

**GENERAL SPECIFICATIONS:**

- Cold rolled steel housing. • Cast steel end caps. • Acrylic diffusers are extruded, 1/8" thick matte white acrylic. • Unit mounts to 2"x3" junction box, with additional holes for mounting direct to structure. • Approved for vertical or horizontal mounting. • Approved for wall mount application only. • Allow 6" to either end of fixture to facilitate mounting of back plate. • Toolless access to lamp. • Visit [www.oxygenlighting.com](http://www.oxygenlighting.com) for technical cut sheets. • Oxygen reserves the right to modify designs at any time.

# TEMPUS VANITY

ADA

LED



3-5002-24

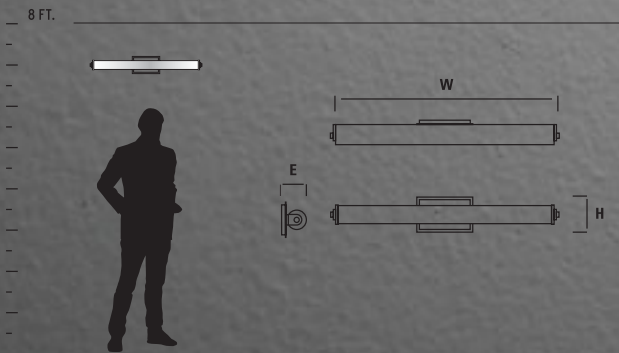











3-5001-20



3-5001-15

ITEM #	DIFFUSER	FINISH	DIMENSIONS	LAMPING	DRIVER	CERTIFICATION
3-5001-XX small	Matte White Acrylic	15 Black 20 Polished Nickel 24 Satin Nickel	18.875"(w) x 5.375"(h) x 4"(ext)	1 x 13w, 90CRI 3000k LED	120V Triac dimming	  
3-5002-XX medium	Matte White Acrylic	15 Black 20 Polished Nickel 24 Satin Nickel	24.5"(w) x 5.375"(h) x 4"(ext)	2 x 9w, 90CRI 3000k LED	120V Triac dimming	  
3-5003-XX large	Matte White Acrylic	15 Black 20 Polished Nickel 24 Satin Nickel	35.5"(w) x 5.375"(h) x 4"(ext)	2 x 13w, 90CRI 3000k LED	120V Triac dimming	  

**GENERAL SPECIFICATIONS:**

• Cold rolled steel housing. • Cast steel end caps. • 1/8" thick matte white acrylic. • Unit mounts to deep 4" octagonal junction box or deep 4"x4" square junction box w/ single device mud ring • Approved for vertical or horizontal mounting. • Approved for wall mount application only. • Unit requires 2.5" deep junction box. • Driver mounts inside junction box. • Total luminaire power for 3-5001 is 15.5w, 3-5002 is 23.0w & 3-5003 is 32.9w. • Visit [www.oxygenlighting.com](http://www.oxygenlighting.com) for technical cut sheets. • Oxygen reserves the right to modify designs at any time.

# VEGA VANITY

ADA

LED



3-569-20

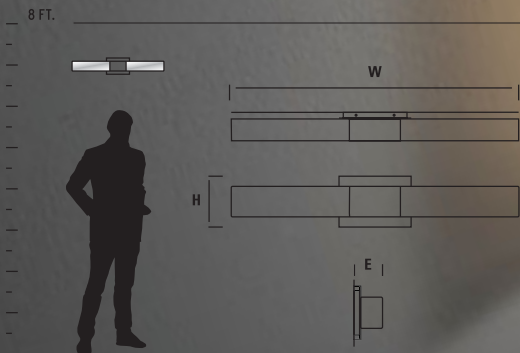



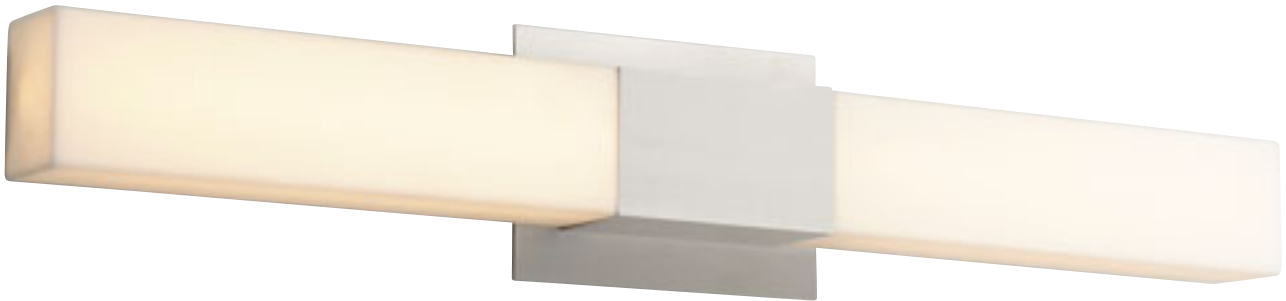

3-569-20



3-569-24

ITEM #	DIFFUSER	FINISH	DIMENSIONS	LAMPING	DRIVER	CERTIFICATION
3-569-XX	Matte White Acrylic	20 Polished Nickel 24 Satin Nickel	27"(w) x 4.75"(h) x 2.625"(ext)	2 x 12.2w, 90CRI 3000k LED	120/277V 0-10V/Phase dimming	  

2700k, 3500k, 4000k color temperatures also available. Visit [oxygenlighting.com](http://oxygenlighting.com)

**GENERAL SPECIFICATIONS:**

- Cold rolled steel housing. • 1/8" thick matte white acrylic. • Unit mounts to 4" octagonal junction box or 4"x4" square junction box w/ single device mud ring • Approved for vertical or horizontal mounting. • Approved for wall mount application only. • Total luminaire power 30.5w. • Visit [www.oxygenlighting.com](http://www.oxygenlighting.com) for technical cut sheets. • Oxygen reserves the right to modify designs at any time.



# WAVE VANITY

ADA

LED



3-5022-15

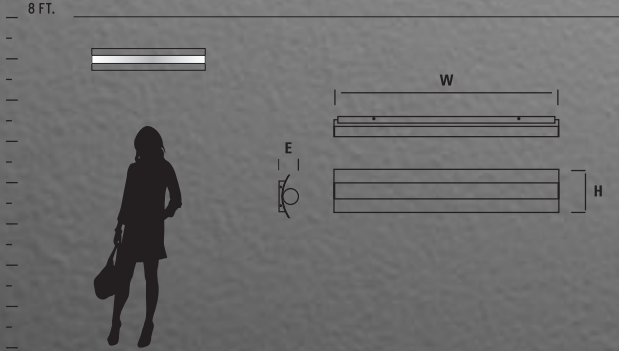





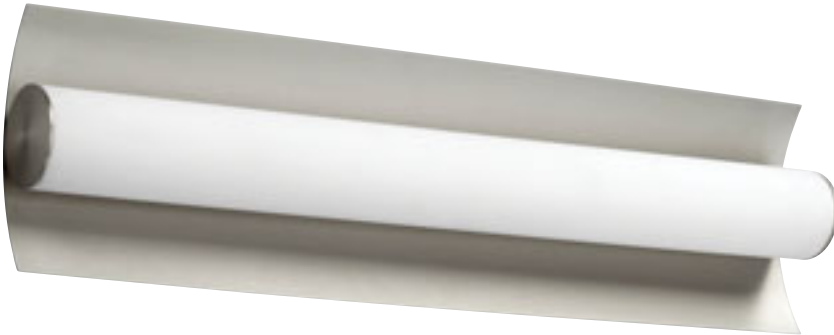





3-5021-15



3-5022-24



3-5023-15

ITEM #	DIFFUSER	FINISH	DIMENSIONS	LAMPING	DRIVER	CERTIFICATION
3-5021-XX small	Matte White Acrylic	15 Black 24 Satin Nickel	17.625"(w) x 6.25"(h) x 3"(ext)	1 x 13w, 90CRI 3000k LED	120V Triac dimming	  
3-5022-XX medium	Matte White Acrylic	15 Black 24 Satin Nickel	23.25"(w) x 6.25"(h) x 3"(ext)	2 x 9w, 90CRI 3000k LED	120V Triac dimming	  
3-5023-XX large	Matte White Acrylic	15 Black 24 Satin Nickel	34.25"(w) x 6.25"(h) x 3"(ext)	2 x 13w, 90CRI 3000k LED	120V Triac dimming	  

**GENERAL SPECIFICATIONS:**

• Cold rolled steel housing. • Cast steel end caps. • 1/8" thick matte white acrylic. • Unit mounts deep 4" octagonal junction box or deep 4"x4" square junction box w/ single device mud ring. • Approved for vertical or horizontal mounting. • Approved for wall mount application only. • Unit requires 2.5" deep junction box. • Driver mounts inside junction box. • Total luminaire power for 3-5021 is 15.5w, 3-5022 is 23.0w & 3-5023 is 32.9w. • Visit [www.oxygenlighting.com](http://www.oxygenlighting.com) for technical cut sheets. • Oxygen reserves the right to modify designs at any time.

# ZENITH II VANITY

ADA

LED

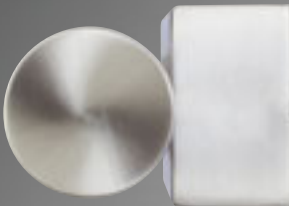

Profile View



3-557-14

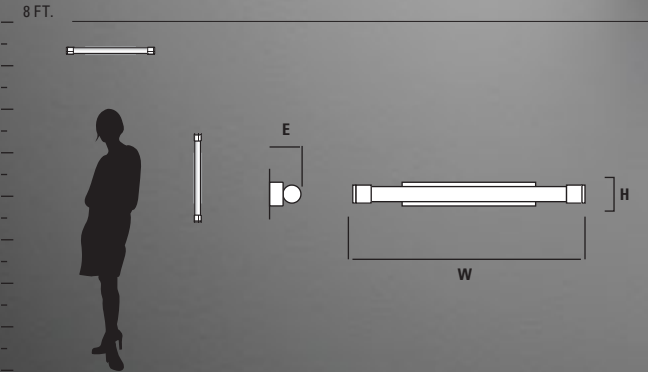

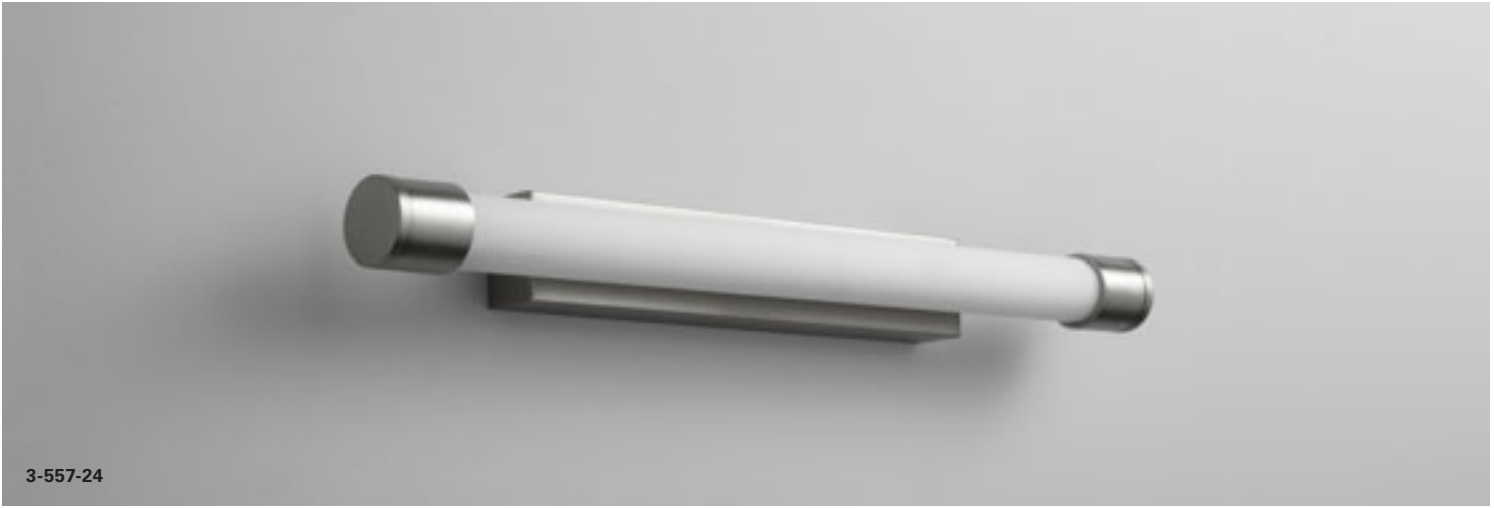







3-557-24



3-557-22



3-559-40

ITEM #	DIFFUSER	FINISH	DIMENSIONS	LAMPING	DRIVER	CERTIFICATION
<b>3-557-XX</b> small	Matte White Acrylic	14 Polished Chrome 22 Oiled Bronze 24 Satin Nickel 40 Aged Brass	24.25"(w) x 2.5"(h) x 3.25"(ext)	1 x 11.6w, 90CRI 3000k LED	120/277V 0-10V/Phase dimming	  
<b>3-559-XX</b> large	Matte White Acrylic	14 Polished Chrome 22 Oiled Bronze 24 Satin Nickel 40 Aged Brass	47.75"(w) x 2.5"(h) x 3.25"(ext)	2 x 11.6w, 90CRI 3000k LED	120/277V 0-10V/Phase dimming	  

2700k, 3500k, 4000k color temperatures also available. Visit [oxygenlighting.com](http://oxygenlighting.com)

**GENERAL SPECIFICATIONS:**

• Cold-rolled steel housing. • Diffuser is 1/8" thick matte white acrylic. • Unit mounts to deep 2"x3" junction box or deep 4"x4" square junction box w/ a single device mud ring. • Approved for vertical or horizontal mounting. • Approved for wall mount application only. • Total luminaire power 14.5w for 3-557-XX and 29.4w for 3-559-XX. • Visit [www.oxygenlighting.com](http://www.oxygenlighting.com) for technical cut sheets. • Oxygen reserves the right to modify designs at any time.

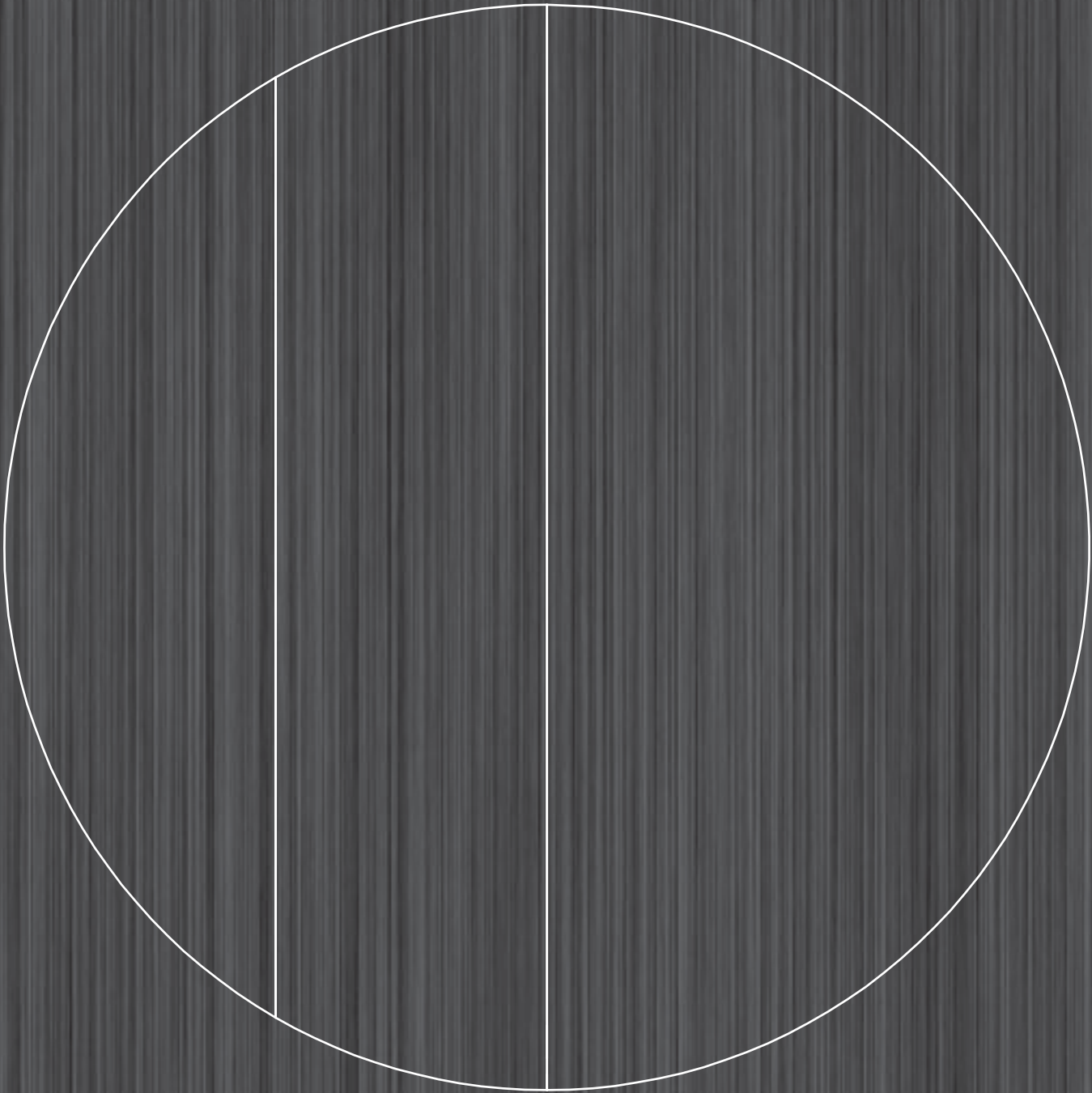
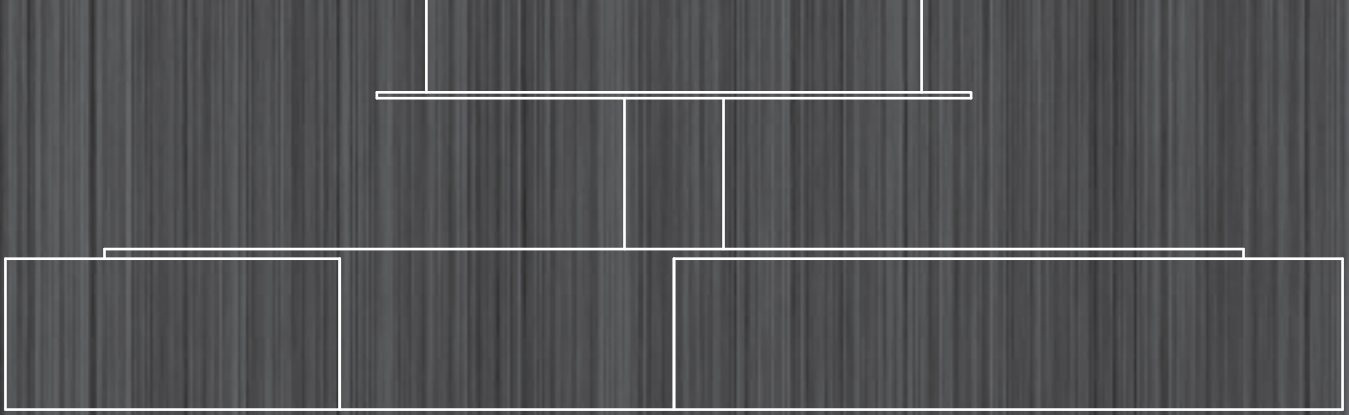

# CEILING MOUNTS



# AURORA CEILING MOUNT

ADA

LED



3-662-24

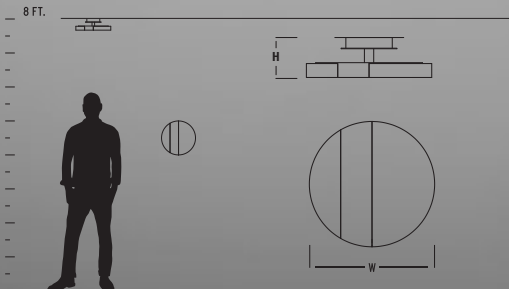





**3-662-15**



**3-662-20**

ITEM #	DIFFUSER	FINISH	DIMENSIONS	LAMPING	DRIVER	CERTIFICATION
<b>3-662-XX</b>	Matte White Acrylic	15 Black 20 Polished Nickel 24 Satin Nickel	13.5"(w) x 4"(h)	1 x 21.5w, 90CRI 3000k LED	120V/277V 0-10V/Phase dimming	  

2700k, 3500k, 4000k color temperatures also available for LED models. Visit [oxygenlighting.com](http://oxygenlighting.com)

**GENERAL SPECIFICATIONS:**

- Cold rolled steel housing. • White acrylic diffuser is 1/16" thick. • Unit mounts to deep 4" octagonal junction box or deep 4"x4" square junction box w/ single device mud ring.
- Approved for wall or ceiling mount applications. • Unit requires 2.5" deep junction box. • Driver mounts inside junction box. • Total luminaire power 25.1w.
- Visit [www.oxygenlighting.com](http://www.oxygenlighting.com) for technical cut sheets. • Oxygen reserves the right to modify designs at any time.

# DIONE CEILING MOUNT

ADA

LED

EM





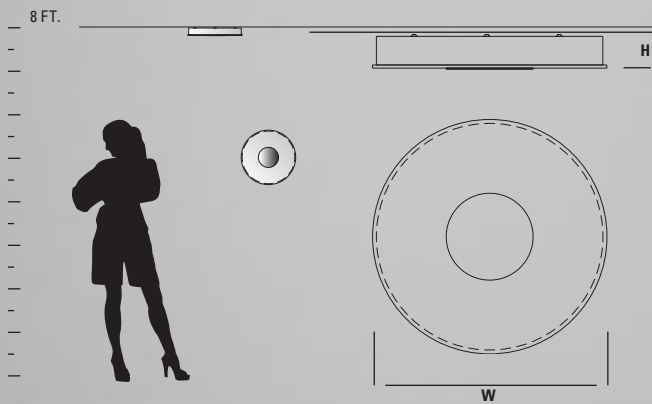







32-664-24





32-665-24

ITEM #	DIFFUSER	FINISH	DIMENSIONS	LAMPING	DRIVER	CERTIFICATION
<b>32-664-24</b> small	Frosted Glass	24 Satin Nickel	15"(w) x 2.25"(h)	1 x 9.9w, 90CRI 3000k LED	120/277V 0-10V dimming	  
<b>32-665-24</b> large	Frosted Glass	24 Satin Nickel	21"(w) x 2.25"(h)	1 x 20.7w, 90CRI 3000k LED	120/277V 0-10V dimming	  
<b>32-665-24-EM</b> large	Frosted Glass	24 Satin Nickel	21"(w) x 2.25"(h)	1 x 20.7w, 90CRI 3000k LED	120/277V 0-10V dimming	   

2700k, 3500k, 4000k color temperatures also available for non EMLED models. Visit [oxygenlighting.com](http://oxygenlighting.com)

**GENERAL SPECIFICATIONS:**

• Spun steel housing. • 1/8" frost white glass diffuser. • Units mount to 4" octagonal junction box. • Approved for wall or ceiling mount applications. • Total luminaire power 11.2w for 32-664-24 and 23.5w for 32-665-24. • Visit [www.oxygenlighting.com](http://www.oxygenlighting.com) for technical cut sheets. • Oxygen reserves the right to modify designs at any time.

**EMERGENCY BATTERY BACKUP MODELS (EM)**

• ETL required 90 minute emergency battery run time • 32 hour recharge time.

# ECHO CEILING MOUNT

LED

EM



3-694-24

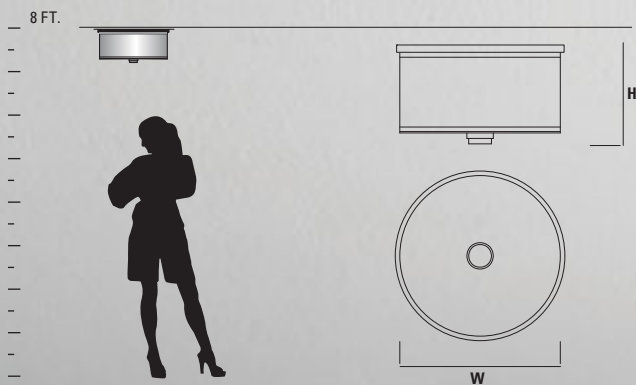









3-694-24



3-695-24

ITEM #	DIFFUSER	FINISH	DIMENSIONS	LAMPING	DRIVER	CERTIFICATION
3-694-24	Grass Shade With White Acrylic	24 Satin Nickel	14.5"(w) x 4"(h)	2 x 10.1w, 90CRI 3000k LED	120/277V 0-10V/Phase dimming	
3-694-24-EM	Grass Shade With White Acrylic	24 Satin Nickel	14.5"(w) x 4"(h)	2 x 10.1w, 90CRI 3000k LED	120/277V 0-10V/Phase dimming	 
3-695-24	Grass Shade With White Acrylic	24 Satin Nickel	14.5"(w) x 7.75"(h)	2 x 10.1w, 90CRI 3000k LED	120/277V 0-10V/Phase dimming	
3-695-24-EM	Grass Shade With White Acrylic	24 Satin Nickel	14.5"(w) x 7.75"(h)	2 x 10.1w, 90CRI 3000k LED	120/277V 0-10V/Phase dimming	 

2700k, 3500k, 4000k color temperatures also available for non EMLED models. Visit [oxygenlighting.com](http://oxygenlighting.com)

**GENERAL SPECIFICATIONS:**

• Cold rolled steel housing. • Grass shades are natural bamboo fibers. • White acrylic diffuser is 1/8" thick. • Cast steel with acrylic finial. • Unit mounts to 4" octagonal junction box. • Approved for ceiling mount applications only. • Total luminaire power 27.5w for 3-694-24 and 26.6w for 3-695-24. • Visit [www.oxygenlighting.com](http://www.oxygenlighting.com) for technical cut sheets. • Oxygen reserves the right to modify designs at any time.

**EMERGENCY BATTERY BACKUP MODELS (EM)**

• ETL required 90 minute emergency battery run time • 32 hour recharge time.



# ELLIPSE CEILING MOUNT





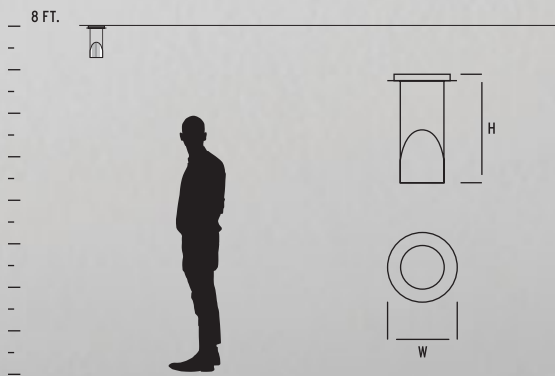

LED



3-354-120





ITEM #	DIFFUSER	FINISH	DIMENSIONS	LAMPING	DRIVER	CERTIFICATION
<b>3-353-XXX</b>	1 Matte Opal Glass 2 Matte White Acrylic	15 Black 20 Polished Nickel 24 Satin Nickel	5.875"(w) x 9.25"(h)	1 x 6.2w, 90CRI 3000k LED	120/277V 0-10V/Phase dimming	  
<b>3-354-XXX</b>	1 Matte Opal Glass 2 Matte White Acrylic	15 Black 20 Polished Nickel 24 Satin Nickel	5.875"(w) x 9.25"(h)	1 x 6.2w, 90CRI 3000k LED	120/277V 0-10V/Phase dimming	  

2700k, 3500k, 4000k color temperatures also available. Visit [oxygenlighting.com](http://oxygenlighting.com)

**GENERAL SPECIFICATIONS:**

- Cold rolled steel housing. • White acrylic diffuser is 1/16" thick. • Glass diffuser is 1/8" matte opal • Models 3-353-XXX has 2.75" dia diffuser • Models 3-354-XXX has 3.5" dia diffuser • Unit mounts to deep 4" octagonal junction box. • Driver mounts inside junction box. • Unit requires 2.5" deep junction box. • Approved for ceiling and wall mounted applications. • Total luminaire power 7.1w. • Visit [www.oxygenlighting.com](http://www.oxygenlighting.com) for technical cut sheets. • Oxygen reserves the right to modify designs at any time.

**IO** CEILING MOUNT

LED EM





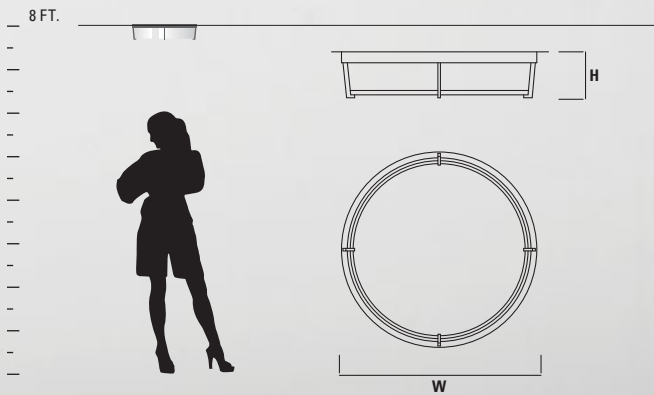



3-689-24





2-699-24

ITEM #	DIFFUSER	FINISH	DIMENSIONS	LAMPING	BALLAST	DRIVER	CERTIFICATION
2-699-24	Matte White Acrylic	24 Satin Nickel	17"(w) x 4 "(h)	22w + 40w T5 circline fluorescent (2GX13)	Electronic, HPF, Programmed Start, Universal Voltage (120-277V)	--	 
3-689-XX	Matte White Acrylic	24 Satin Nickel 40 Aged Brass	17"(w) x 4 "(h)	2 x 10.1w, 90CRI 3000k LED	--	120/277V 0-10V/Phase dimming	 
3-689-XX-EM	Matte White Acrylic	24 Satin Nickel 40 Aged Brass	17"(w) x 4 "(h)	2 x 10.1w, 90CRI 3000k LED	--	120/277V 0-10V/Phase dimming	  

2700k, 3500k, 4000k color temperatures also available for non EMLED models. Visit [oxygenlighting.com](http://oxygenlighting.com)

**GENERAL SPECIFICATIONS:**

• Cold rolled steel housing. • Matte white acrylic is formed 1/16" thick. • Unit mounts to 4" octagonal junction box. • Toolless access to lamp for fluorescent model. • Approved for ceiling mount applications only. • Total luminaire power 25.6w for LED models. • Visit [www.oxygenlighting.com](http://www.oxygenlighting.com) for technical cut sheets. • Oxygen reserves the right to modify designs at any time.

**EMERGENCY BATTERY BACKUP MODELS (EM)**

• ETL required 90 minute emergency battery run time • 32 hour recharge time.

# JOURNEY CEILING MOUNT

LED



3-624-14















3-622-24



3-626-24

ITEM #	DIFFUSER	FINISH	DIMENSIONS	LAMPING	DRIVER	CERTIFICATION
3-622-24 small	Matte Opal Glass	24 Satin Nickel	11"(w) x 4.5"(h)	1 x 8.2w, 90CRI 3000k LED	120/277V 0-10V/Phase dimming	 
3-623-XX medium	Matte Opal Glass	14 Polished Chrome 24 Satin Nickel	14"(w) x 4.5"(h)	1 x 10.1w, 90CRI 3000k LED	120/277V 0-10V/Phase dimming	 
3-624-XX medium	Matte Opal Glass	14 Polished Chrome 24 Satin Nickel	14"(w) x 4.5"(h)	2 x 10.1w, 90CRI 3000k LED	120/277V 0-10V/Phase dimming	 
3-625-24 medium	Matte White Acrylic	24 Satin Nickel	14"(w) x 4.5"(h)	1 x 10.1w, 90CRI 3000k LED	120/277V 0-10V/Phase dimming	 
3-626-XX medium	Matte White Acrylic	14 Polished Chrome 24 Satin Nickel	14"(w) x 4.5"(h)	2 x 10.1w, 90CRI 3000k LED	120/277V 0-10V/Phase dimming	 

2700k, 3500k, 4000k color temperatures also available. Contact Visit [oxygenlighting.com](http://oxygenlighting.com)

**GENERAL SPECIFICATIONS:**

- Spun steel housing. • Matte white acrylic is 1/16" thick. • Opal glass diffuser is 1/8" thick. • Unit mounts to 4" octagonal junction box. • Approved for ceiling mount applications only.
- Total luminaire power 10.1w for 3-622-24, 13.03w for 3-623-XX, 25.7w for 3-624-XX, 12.9w for 3-625-24, and 25.9w for 3-626-XX. • Visit [www.oxygenlighting.com](http://www.oxygenlighting.com) for technical cut sheets. • Oxygen reserves the right to modify designs at any time.



# JOURNEY CEILING MOUNT

LED

EM



3-623-24-EM











3-625-24-EM



3-623-14-EM

ITEM #	DIFFUSER	FINISH	DIMENSIONS	LAMPING	DRIVER	CERTIFICATION
<b>3-623-XX-EM</b> medium	Matte Opal Glass	14 Polished Chrome 24 Satin Nickel	14"(w) x 4.5"(h)	1 x 10.1w, 90CRI 3000k LED	120/277V 0-10V/Phase dimming	  
<b>3-625-24-EM</b> medium	Matte White Acrylic	24 Satin Nickel	14"(w) x 4.5"(h)	1 x 10.1w, 90CRI 3000k LED	120/277V 0-10V/Phase dimming	  

**GENERAL SPECIFICATIONS:**

- Spun steel housing. • Matte white acrylic is 1/16" thick. • Opal glass diffuser is 1/8" thick. • Unit mounts to 4" octagonal junction box. • Approved for ceiling mount applications only.
- Total luminaire power 13.03w for 3-623-XX-EM, 12.9w for 3-625-24-EM. • Visit [www.oxygenlighting.com](http://www.oxygenlighting.com) for technical cut sheets. • Oxygen reserves the right to modify designs at any time.

**EMERGENCY BATTERY BACKUP MODELS (EM)**

- ETL required 90 minute emergency battery run time • 32 hour recharge time.

# MODULO CEILING MOUNT

LED EM



3-683-24









3-683-24



3-683-40-EM

ITEM #	DIFFUSER	FINISH	DIMENSIONS	LAMPING	DRIVER	CERTIFICATION
<b>3-683-XX</b> large	Matte White Acrylic	24 Satin Nickel 40 Aged Brass	16"(w) x 4.75"(h)	2 x 10.1w, 90CRI 3000k LED	120V 0-10V/Phase dimming	 
<b>3-683-XX-EM</b> large	Matte White Acrylic	24 Satin Nickel 40 Aged Brass	16"(w) x 4.75"(h)	2 x 10.1w, 90CRI 3000k LED	120V 0-10V/Phase dimming	  

2700k, 3500k, 4000k color temperatures also available for non EMLED models. Visit [oxygenlighting.com](http://oxygenlighting.com)

**GENERAL SPECIFICATIONS:**

• Cold rolled steel housing. • Matte white acrylic is formed 1/16" thick. • Unit mounts to 4" octagonal junction box. • Approved for ceiling mount applications only. • Total luminaire power 26.2w for 3-683-XX. • Visit [www.oxygenlighting.com](http://www.oxygenlighting.com) for technical cut sheets. • Oxygen reserves the right to modify designs at any time.

**EMERGENCY BATTERY BACKUP MODELS (EM)**

• ETL required 90 minute emergency battery run time • 32 hour recharge time.

# ORACLE CEILING MOUNT

ADA

LED



3-620-24

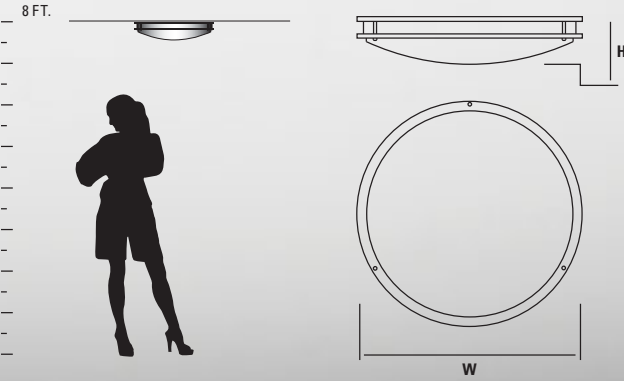









3-618-22



3-620-40

ITEM #	DIFFUSER	FINISH	DIMENSIONS	LAMPING	DRIVER	CERTIFICATION
<b>3-618-XX</b> small	Matte White Acrylic	14 Polished Chrome 22 Oiled Bronze 24 Satin Nickel 40 Aged Brass	10.5"(w) x 3.5"(h)	1 x 8.2w, 90CRI 3000k LED	120/277V 0-10V/Phase dimming	  
<b>3-619-XX</b> medium	Matte White Acrylic	14 Polished Chrome 22 Oiled Bronze 24 Satin Nickel 40 Aged Brass	17.75"(w) x 4.25"(h)	1 x 10.1w, 90CRI 3000k LED	120/277V 0-10V/Phase dimming	 
<b>3-620-XX</b> medium	Matte White Acrylic	14 Polished Chrome 22 Oiled Bronze 24 Satin Nickel 40 Aged Brass	17.75"(w) x 4.25"(h)	2 x 10.1w, 90CRI 3000k LED	120/277V 0-10V/Phase dimming	 

2700k, 3500k, 4000k color temperatures also available. Visit [oxygenlighting.com](http://oxygenlighting.com)

**GENERAL SPECIFICATIONS:**

• Cold rolled steel housing. • Formed steel trim. • White acrylic diffuser is 1/16" thick. • Unit mounts to 4" octagonal junction box. • Approved for wall or ceiling mount applications. • Total luminaire power 10.4w for 3-618-XX, 13.2w for 3-619-XX, and 26.3w for 3-620-XX. • Visit [www.oxygenlighting.com](http://www.oxygenlighting.com) for technical cut sheets. • Oxygen reserves the right to modify designs at any time.



# ORACLE CEILING MOUNT

LED EM



3-619-40-EM

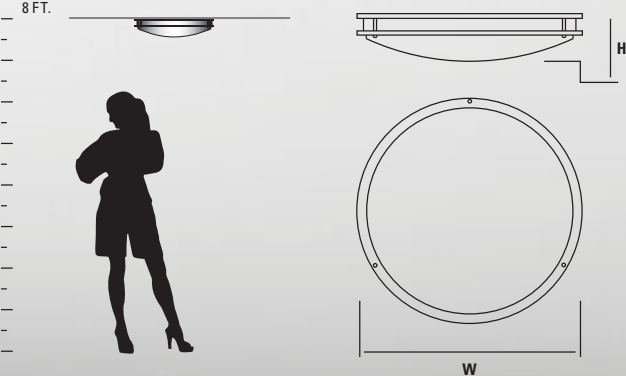





3-619-22-EM



3-620-24-EM

ITEM #	DIFFUSER	FINISH	DIMENSIONS	LAMPING	DRIVER	CERTIFICATION
<b>3-619-XX-EM</b> medium	Matte White Acrylic	14 Polished Chrome 22 Oiled Bronze 24 Satin Nickel 40 Aged Brass	17.75"(w) x 4.25"(h)	1 x 10.1w, 90CRI 3000k LED	120/277V 0-10V/Phase dimming	
<b>3-620-XX-EM</b> medium	Matte White Acrylic	14 Polished Chrome 22 Oiled Bronze 24 Satin Nickel 40 Aged Brass	17.75"(w) x 4.25"(h)	2 x 10.1w, 90CRI 3000k LED	120/277V 0-10V/Phase dimming	

**GENERAL SPECIFICATIONS:**

• Cold rolled steel housing. • Formed steel trim. • White acrylic diffuser is 1/16" thick. • Unit mounts to 4" octagonal junction box. • Approved for wall or ceiling mount applications. • Total luminaire power 13.2w for 3-619-XX-EM, and 26.3w for 3-620-XX-EM. • Visit [www.oxygenlighting.com](http://www.oxygenlighting.com) for technical cut sheets. • Oxygen reserves the right to modify designs at any time.

**EMERGENCY BATTERY BACKUP MODELS (EM)**

• ETL required 90 minute emergency battery run time • 32 hour recharge time.

# PEEPERS CEILING MOUNT

ADA

LED



3-600-24

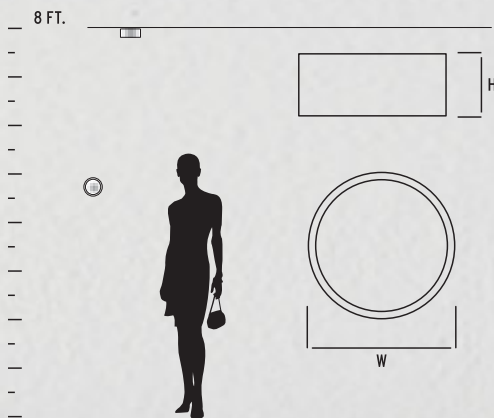





3-600-40



3-600-22

ITEM #	DIFFUSER	FINISH	DIMENSIONS	LAMPING	DRIVER	CERTIFICATION
3-600-XX	Matte White Acrylic	22 Oiled Bronze 24 Satin Nickel 40 Aged Brass	4.75"(w) x 2"(h)	1 x 8.2w, 90CRI 3000k LED	120/277V 0-10V/Phase dimming	  

2700k, 3500k, 4000k color temperatures also available. Visit [oxygenlighting.com](http://oxygenlighting.com)

**GENERAL SPECIFICATIONS:**

• Cold rolled steel housing. • White acrylic diffuser is 1/16" thick. • Unit mounts to deep 4" octagonal junction box. • Unit requires 2.5" deep junction box. • Driver mounts inside junction box. • Approved for ceiling and wall mounted applications. • Total luminaire power 10.2w. • Visit [www.oxygenlighting.com](http://www.oxygenlighting.com) for technical cut sheets. • Oxygen reserves the right to modify designs at any time.



# PEEPERS CEILING MOUNT

ADA

LED

EM



32-601-40

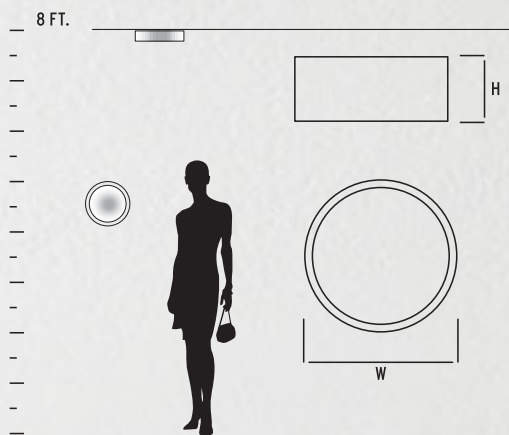









32-601-20



32-601-24

ITEM #	DIFFUSER	FINISH	DIMENSIONS	LAMPING	DRIVER	CERTIFICATION
32-601-XX	Matte White Acrylic	20 Polished Nickel 24 Satin Nickel 40 Aged Brass	10.25"(w) x 2.5"(h)	1 x 18w, 90CRI 3000k LED	120/277V 0-10V dimming	  
32-601-XX-EM	Matte White Acrylic	20 Polished Nickel 24 Satin Nickel 40 Aged Brass	10.25"(w) x 2.5"(h)	1 x 18w, 90CRI 3000k LED	120/277V 0-10V dimming	   

2700k, 3500k, 4000k color temperatures also available for non EMLED models. Visit [oxygenlighting.com](http://oxygenlighting.com)

**GENERAL SPECIFICATIONS:**

• Cold rolled steel housing. • White acrylic diffuser is 1/16" thick. • Unit mounts to deep 4" octagonal or deep 2"x3" junction box. • Approved for ceiling and wall mounted applications. • Total luminaire power 21.2w. • Visit [www.oxygenlighting.com](http://www.oxygenlighting.com) for technical cut sheets. • Oxygen reserves the right to modify designs at any time.

**EMERGENCY BATTERY BACKUP MODELS (EM)**

• ETL required 90 minute emergency battery run time • 32 hour recharge time.



# PILAR CEILING MOUNT

LED



3-309-115

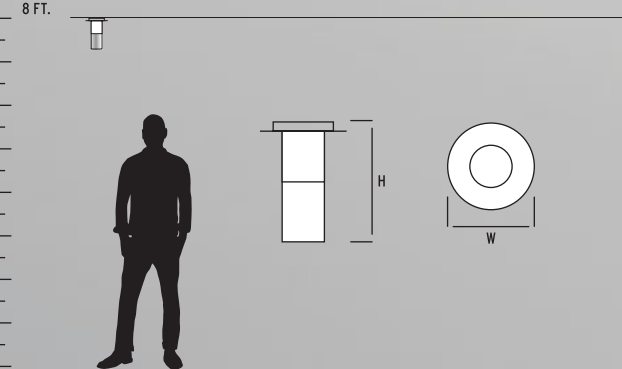









3-308-120



3-309-224

ITEM #	DIFFUSER	FINISH	DIMENSIONS	LAMPING	DRIVER	CERTIFICATION
<b>3-308-XXX</b>	1 Matte Opal Glass 2 Matte White Acrylic	15 Black 20 Polished Nickel 24 Satin Nickel	5.875"(w) x 9"(h)	1 x 6.2w, 90CRI 3000k LED	120/277V 0-10V/Phase dimming	  
<b>3-309-XXX</b>	1 Matte Opal Glass 2 Matte White Acrylic	15 Black 20 Polished Nickel 24 Satin Nickel	5.875"(w) x 10.75"(h)	1 x 6.2w, 90CRI 3000k LED	120/277V 0-10V/Phase dimming	  

2700k, 3500k, 4000k color temperatures also available. Visit [oxygenlighting.com](http://oxygenlighting.com)

**GENERAL SPECIFICATIONS:**

• Cold rolled steel housing. • White acrylic diffuser is 1/16" thick. • Glass difusser is 1/8" thick matte opal • Diffuser screws onto housing with integral threaded fitting. • Model 3-308-XXX has 2.75" dia diffuser • Model 3-309-XXX has 3.5" dia diffuser • Unit mounts to deep 4" octagonal junction box. • Driver mounts inside junction box. • Unit requires 2.5" deep junction box. • Approved for ceiling and wall mounted applications. • Total luminaire power 7.1w. • Visit [www.oxygenlighting.com](http://www.oxygenlighting.com) for technical cut sheets. • Oxygen reserves the right to modify designs at any time.

# PYXIS CEILING MOUNT

ADA

LED



3-610-24

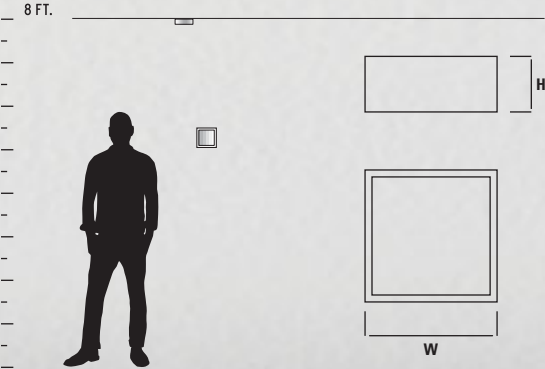



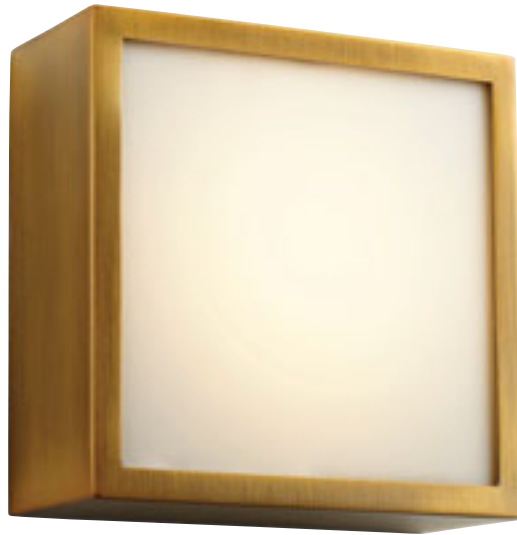

3-610-22



3-610-40

ITEM #	DIFFUSER	FINISH	DIMENSIONS	LAMPING	DRIVER	CERTIFICATION
3-610-XX	Matte White Acrylic	22 Oiled Bronze 24 Satin Nickel 40 Aged Brass	4.75"(w) x 2"(h)	1 x 8.2w, 90CRI 3000k LED	120/277V 0-10V/Phase dimming.	  

2700k, 3500k, 4000k color temperatures also available. Visit [oxygenlighting.com](http://oxygenlighting.com)

**GENERAL SPECIFICATIONS:**

- Cold rolled steel housing.
- White acrylic diffuser is 1/16" thick.
- Unit mounts to deep 4" octagonal junction box.
- Driver mounts inside junction box.
- Unit requires 2.5" deep junction box.
- Approved for ceiling and wall mounted applications.
- Total luminaire power 10.3w.
- Visit [www.oxygenlighting.com](http://www.oxygenlighting.com) for technical cut sheets.
- Oxygen reserves the right to modify designs at any time.

# PYXIS CEILING MOUNT

ADA

LED



32-612-40

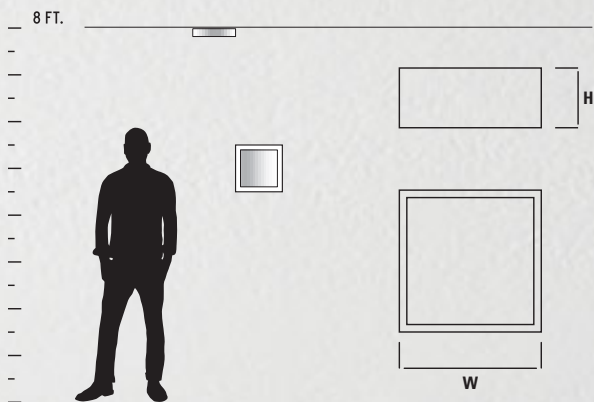





32-612-20



32-612-24

ITEM #	DIFFUSER	FINISH	DIMENSIONS	LAMPING	DRIVER	CERTIFICATION
32-612-XX	Matte White Acrylic	20 Polished Nickel 24 Satin Nickel 40 Aged Brass	10.25"(w) x 3.25"(h)	1 x 22.2w, 90CRI 3000k LED	120/277V 0-10V dimming	  

2700k, 3500k, 4000k color temperatures also available. Visit [oxygenlighting.com](http://oxygenlighting.com)

**GENERAL SPECIFICATIONS:**

• Cold rolled steel housing. • White acrylic diffuser is 1/16" thick. • Unit mounts to deep 4" octagonal or deep 2"x3" junction box. • Approved for ceiling and wall mounted applications. • Total luminaire power 26.1w. • Visit [www.oxygenlighting.com](http://www.oxygenlighting.com) for technical cut sheets. • Oxygen reserves the right to modify designs at any time.



# RHYTHM CEILING MOUNT

ADA

LED

FLOURESCENT



3-648-6 and 3-649-6

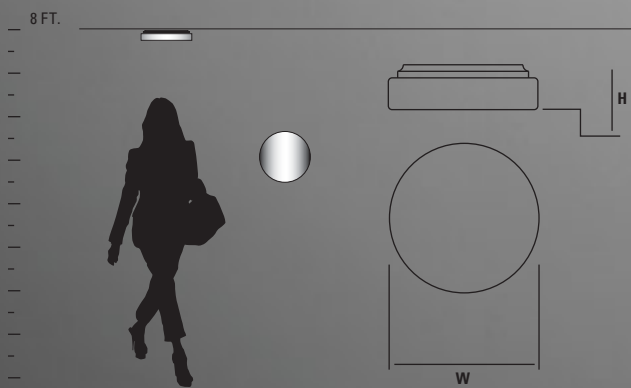















2-6138-6



3-649-6

ITEM #	DIFFUSER	FINISH	DIMENSIONS	LAMPING	BALLAST	DRIVER	CERTIFICATION
<b>2-6138-6</b> small	Matte White Acrylic	6 White	10"(w) x 3"(h)	1 x 22w T9 circline fluorescent (G10Q)	Electronic HPF, instant start, 120V	--	  
<b>2-6139-6</b> large	Matte White Acrylic	6 White	14"(w) x 2.75"(h)	22w + 32w T9 circline fluorescent (G10Q)	Electronic HPF, instant start, 120V	--	  
<b>3-648-6</b> small	Matte White Acrylic	6 White	10"(w) x 3"(h)	1 x 8.2w, 90CRI 3000k LED	--	120/277V 0-10V/Phase dimming	  
<b>3-649-6</b> large	Matte White Acrylic	6 White	14"(w) x 2.75"(h)	2 x 10.1w, 90CRI 3000k LED	--	120/277V 0-10V/Phase dimming	  

2700k, 3500k, 4000k color temperatures also available. Visit [oxygenlighting.com](http://oxygenlighting.com)

**GENERAL SPECIFICATIONS:**

• Cold rolled steel housing. • White acrylic diffuser is 1/16" thick. • Unit mounts to 4" octagonal junction box. • Toolless access to lamp for fluorescent models. • Approved for wall or ceiling mount applications. • Total luminaire power 10.3w for 3-648-6 and 25.8w for 3-649-6. • Visit [www.oxygenlighting.com](http://www.oxygenlighting.com) for technical cut sheets. • Oxygen reserves the right to modify designs at any time.

# ZURI CEILING MOUNT

ADA

LED



32-630-15

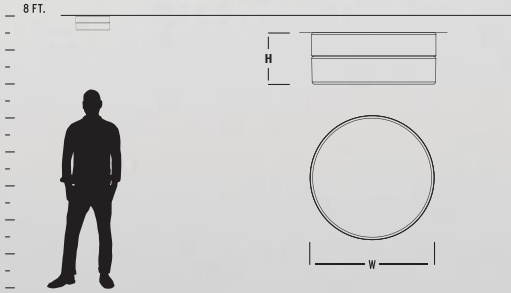









32-630-40



32-631-24

ITEM #	DIFFUSER	FINISH	DIMENSIONS	LAMPING	DRIVER	CERTIFICATION
32-630-XX	Matte White Acrylic	15 Black 24 Satin Nickel 40 Aged Brass	7.25"(w) x 3"(h)	1 x 8.2w, 90CRI 3000k LED	120V/277V 0-10V/Phase dimming	  
32-631-XX	Matte White Acrylic	15 Black 24 Satin Nickel 40 Aged Brass	11.25"(w) x 3.5"(h)	1 x 20.7w, 90CRI 3000k LED	120V/277V 0-10V/Phase dimming	  

2700k, 3500k, 4000k color temperatures also available for LED models. Visit [oxygenlighting.com](http://oxygenlighting.com)

**GENERAL SPECIFICATIONS:**

- Unit mounts to deep 4" octagonal junction box or deep 4"x4" square junction box w/ single device mud ring.
- Approved for ceiling mount applications only.
- Unit requires 2.5" deep junction box.
- Driver mounts inside junction box.
- Total luminaire power 10.1w.
- Visit [www.oxygenlighting.com](http://www.oxygenlighting.com) for technical cut sheets.
- Oxygen reserves the right to modify designs at any time.





# PENDANTS





# CORNET PENDANT

LED

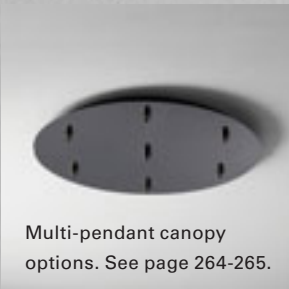

3-651-1314

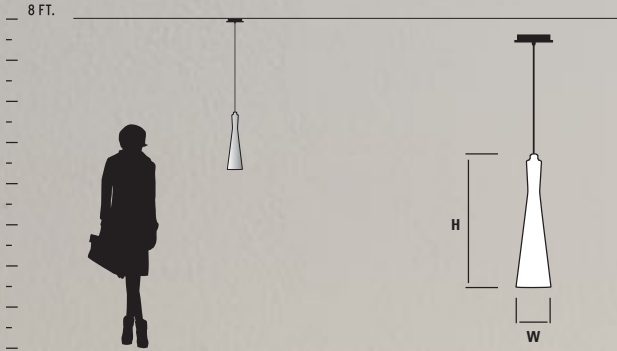



ITEM #	DIFFUSER	FINISH	DIMENSIONS	LAMPING	DRIVER	CERTIFICATION
<b>3-651-14</b>	Clear Glass	14 Polished Chrome	4.25"(w) x 17.25"(h)*	1 x 6.2w, 90CRI 3000k LED	120/277V 0-10V/Phase dimming	
<b>3-651-1314</b>	<b>13</b> Smoked Ombre Glass	14 Polished Chrome	4.25"(w) x 17.25"(h)*	1 x 6.2w, 90CRI 3000k LED	120/277V 0-10V/Phase dimming	
<b>3-651-2018</b>	<b>20</b> Coffee Ombre Glass	18 Gunmetal	4.25"(w) x 17.25"(h)*	1 x 6.2w, 90CRI 3000k LED	120/277V 0-10V/Phase dimming	

2700k, 3500k, 4000k color temperatures also available. Visit [oxygenlighting.com](http://oxygenlighting.com)

**GENERAL SPECIFICATIONS:**

• Cold rolled steel canopy. • Blown glass is 1/16" thick. • \*Height measured not including adjustable cord or ceiling canopy. • Fixture supplied with 10' cord. • Unit mounts to 4" octagonal junction box. • Optional multi-pendant canopies available for 3, 5, and 7 lights. • Unit requires 2.5" deep junction box. • Driver mounts inside junction box. • Total luminaire power 7.1w. • Visit [www.oxygenlighting.com](http://www.oxygenlighting.com) for technical cut sheets. • Oxygen reserves the right to modify designs at any time.

# ECHO PENDANT





LED

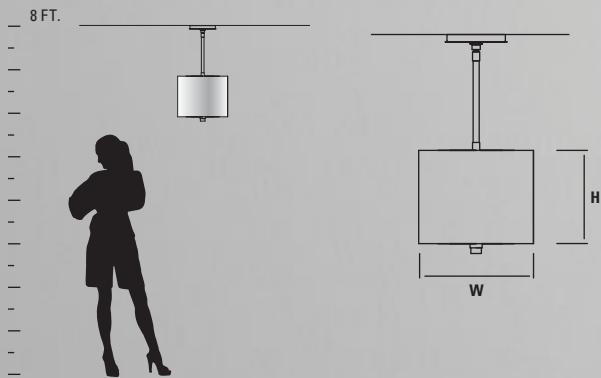

3-639-24





ITEM #	DIFFUSER	FINISH	DIMENSIONS	LAMPING	DRIVER	CERTIFICATION
<b>3-639-24</b> medium	White Grass Shade with Acrylic	24 Satin Nickel	24"(w) x 10.625"(h)*	3 x 9w, 90CRI 3000k LED	120/277V 0-10V/Phase dimming	 
<b>3-640-24</b> large	White Grass Shade with Acrylic	24 Satin Nickel	30"(w) x 10.625"(h)*	4 x 9w, 90CRI 3000k LED	120/277V 0-10V/Phase dimming	 

2700k, 3500k, 4000k color temperatures also available. Visit [oxygenlighting.com](http://oxygenlighting.com)

**GENERAL SPECIFICATIONS:**

- Cold rolled Steel Canopy. • Grass shades are natural bamboo fibers. • Acrylic diffuser. • Cast steel with acrylic finial. • \*Height measured not including stem or ceiling canopy.
- Stem is custom cut at oxygen facility to customer's specification (maximum stem length 60"). • Canopy swivel allows for mounting on sloped ceilings – up to 30-degrees.
- Unit mounts to 4" octagonal junction box. • Total luminaire power 38.9w for 3-639-24, and 52.6w for 3-640-24. • Visit [www.oxygenlighting.com](http://www.oxygenlighting.com) for technical cut sheets.
- Oxygen reserves the right to modify designs at any time.

# ELLIPSE PENDANT

LED



3-677-124

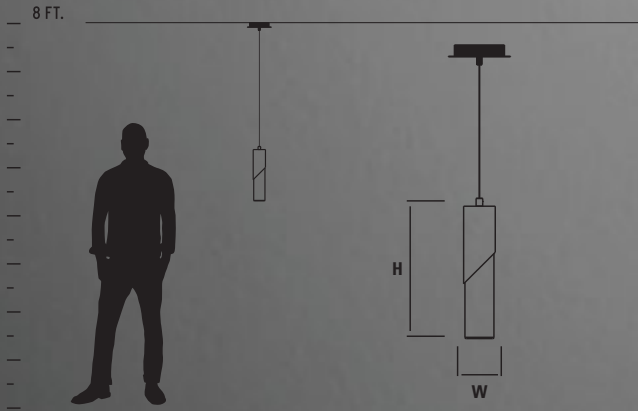



3-677-215











3-668-220



3-678-224



3-668-120

ITEM #	DIFFUSER	FINISH	DIMENSIONS	LAMPING	DRIVER	CERTIFICATION
<b>3-667-XXX</b>	1 White Opal Glass 2 Matte White Acrylic	15 Black 20 Polished Nickel 24 Satin Nickel	3"(w) x 9.25"(h)*	1 x 6.2w, 90CRI 3000k LED	120/277V 0-10V/Phase dimming	 
<b>3-668-XXX</b>	1 White Opal Glass 2 Matte White Acrylic	15 Black 20 Polished Nickel 24 Satin Nickel	3"(w) x 13.25"(h)*	1 x 6.2w, 90CRI 3000k LED	120/277V 0-10V/Phase dimming	 
<b>3-677-XXX</b>	1 White Opal Glass 2 Matte White Acrylic	15 Black 20 Polished Nickel 24 Satin Nickel	3.75"(w) x 10.75"(h)*	1 x 6.2w, 90CRI 3000k LED	120/277V 0-10V/Phase dimming	 
<b>3-678-XXX</b>	1 White Opal Glass 2 Matte White Acrylic	15 Black 20 Polished Nickel 24 Satin Nickel	3.75"(w) x 16.75"(h)*	1 x 6.2w, 90CRI 3000k LED	120/277V 0-10V/Phase dimming	 

2700k, 3500k, 4000k color temperatures also available. Visit [oxygenlighting.com](http://oxygenlighting.com)

**GENERAL SPECIFICATIONS:**

- Cold rolled steel canopy. • Blown glass and acrylic diffusers are 1/8" thick. • \*Height measured not including adjustable cord or ceiling canopy. • Fixture supplied with 10' cord.
- Unit mounts to deep 4" octagonal junction box or deep 4"x4" square junction box w/ single device mud ring. • Optional multi-pendant canopies available for 3, 5, and 7 lights.
- Unit requires 2.5" deep junction box. • Driver mounts inside junction box. • Total luminaire power 7.1w. • Visit [www.oxygenlighting.com](http://www.oxygenlighting.com) for technical cut sheets. • Oxygen reserves the right to modify designs at any time.



# GALAXY PENDANT

LED

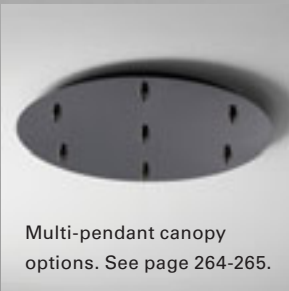

3-634-2018

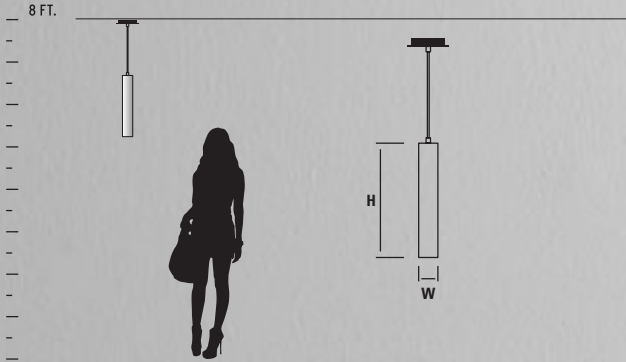



**3-634-1314**



**3-634-1314**



**3-634-2018**

ITEM #	DIFFUSER	FINISH	DIMENSIONS	LAMPING	DRIVER	CERTIFICATION
<b>3-634-1314</b>	<b>13</b> Smoked Ombre Glass	<b>14</b> Polished Chrome	2.75"(w) x 17"(h)	1 x 6.2w, 90CRI 3000k LED	120/277V 0-10V/Phase dimming	
<b>3-634-2018</b>	<b>20</b> Coffee Ombre Glass	<b>18</b> Gunmetal	2.75"(w) x 17"(h)	1 x 6.2w, 90CRI 3000k LED	120/277V 0-10V/Phase dimming	

2700k, 3500k, 4000k color temperatures also available. Visit [oxygenlighting.com](http://oxygenlighting.com)

**GENERAL SPECIFICATIONS:**

• Cold rolled steel canopy. • Blown glass is 1/16" thick. • \*Height measured not including adjustable cord or ceiling canopy. • Fixture supplied with 10' cord. • Unit mounts to 4" octagonal junction box or deep 4"x4" square junction box w/ single device mud ring. • Optional multi-pendant canopies available for 3, 5, and 7 lights. • Unit requires 2.5" deep junction box. • Driver mounts inside junction box. • Total luminaire power 7.1w. • Visit [www.oxygenlighting.com](http://www.oxygenlighting.com) for technical cut sheets. • Oxygen reserves the right to modify designs at any time.

# GRATIS PENDANT

LED



Multi-pendant canopy options. See page 264-265.



3-609-1414

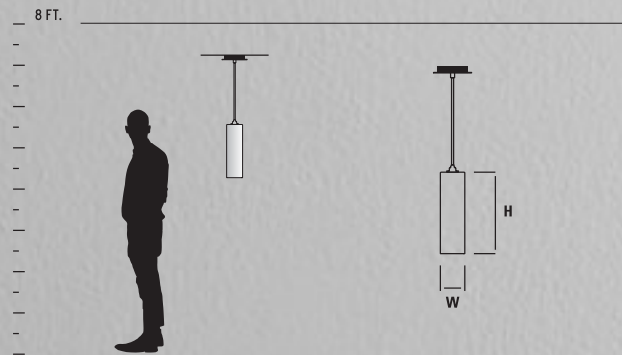



ITEM #	DIFFUSER	FINISH	DIMENSIONS	LAMPING	DRIVER	CERTIFICATION
<b>3-609-14</b>	Clear Glass	14 Polished Chrome	3.75"(w) x 15.5"(h)	1 x 6.2w, 90CRI 3000k LED	120/277V 0-10V/Phase dimming	
<b>3-609-124</b>	Satin Opal Glass	24 Satin Nickel	3.75"(w) x 15.5"(h)	1 x 6.2w, 90CRI 3000k LED	120/277V 0-10V/Phase dimming	
<b>3-609-1414</b>	14 Mirrored Glass	14 Polished Chrome	3.75"(w) x 15.5"(h)	1 x 6.2w, 90CRI 3000k LED	120/277V 0-10V/Phase dimming	

2700k, 3500k, 4000k color temperatures also available. Visit [oxygenlighting.com](http://oxygenlighting.com)

**GENERAL SPECIFICATIONS:**

• Cold rolled steel canopy. • Blown glass is 1/16" thick. • \*Height measured not including adjustable cord or ceiling canopy. • Fixture supplied with 10' cord. • Unit mounts to 4" octagonal junction box or deep 4"x4" square junction box w/ single device mud ring. • Optional multi-pendant canopies available for 3, 5, and 7 lights. • Unit requires 2.5" deep junction box. • Driver mounts inside junction box. • Total luminaire power 7.1w. • Visit [www.oxygenlighting.com](http://www.oxygenlighting.com) for technical cut sheets. • Oxygen reserves the right to modify designs at any time.

# IDOL PENDANT

LED



3-635-24

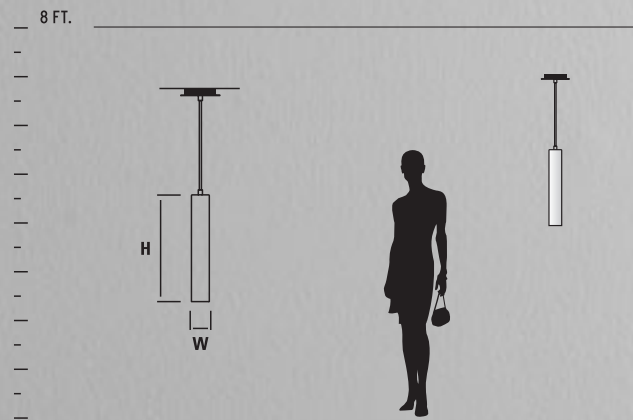



ITEM #	FINISH/DIFFUSER	DIMENSIONS	LAMPING	DRIVER	CERTIFICATION
<b>3-635-XX</b>	14 Polished Chrome 18 Gunmetal 24 Satin Nickel	2.75"(w) x 18.5"(h)*	1 x 6.2w, 90CRI 3000k LED	120/277V 0-10V/Phase dimming	

2700k, 3500k, 4000k color temperatures also available. Visit [www.oxygenlighting.com](http://www.oxygenlighting.com)

**GENERAL SPECIFICATIONS:**

• Cold rolled steel canopy. • \*Height measured not including adjustable cord or ceiling canopy. • Fixture supplied with 10' cord. • Unit mounts to 4" octagonal junction box or deep 4"x4" square junction box w/ single device mud ring. • Optional multi-pendant canopies available for 3, 5, and 7 lights. • Unit requires 2.5" deep junction box. • Driver mounts inside junction box. • Total luminaire power 7.1w. • Visit [www.oxygenlighting.com](http://www.oxygenlighting.com) for technical cut sheets. • Oxygen reserves the right to modify designs at any time.



# KLONE PENDANT

LED



32-642-15

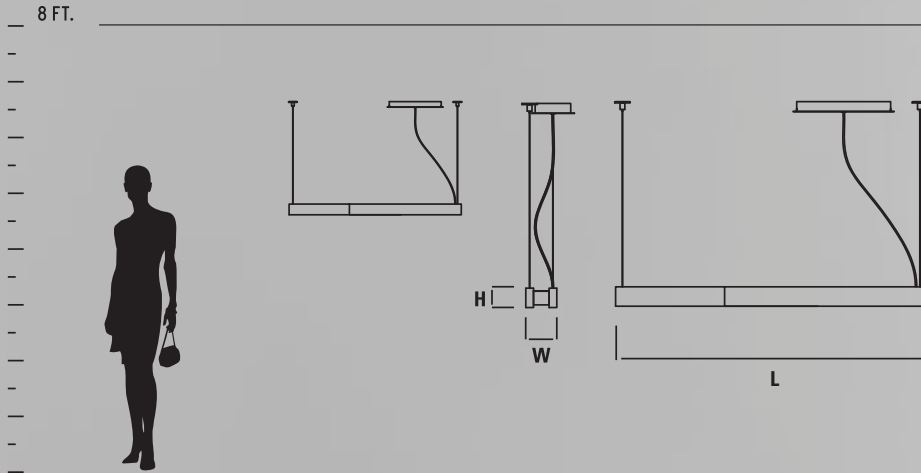





32-642-24



32-642-20

ITEM #	DIFFUSER	FINISH	DIMENSIONS	LAMPING	DRIVER	CERTIFICATION
32-642-XX	Matte White Acrylic	15 Black 20 Polished Nickel 24 Satin Nickel	38"(l) x 4"x(w) 2.5"(h)*	2 x 25w, 90CRI 3000k LED	120/277V 0-10V dimming	 

2700k, 3500k, 4000k color temperatures also available. Visit [oxygenlighting.com](http://oxygenlighting.com)

**GENERAL SPECIFICATIONS:**

- Cold rolled steel canopy. • Unit mounts to 4" octagonal junction box. • Fixture supplied with 10' cord and 12.5' aircraft cable. • Total luminaire power 56.7w.
- Visit [www.oxygenlighting.com](http://www.oxygenlighting.com) for technical cut sheets. • Oxygen reserves the right to modify designs at any time.

# LIBERTY PENDANT

LED

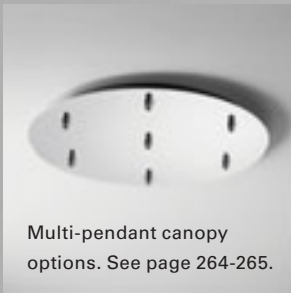

Multi-pendant canopy options. See page 264-265.



3-652-14

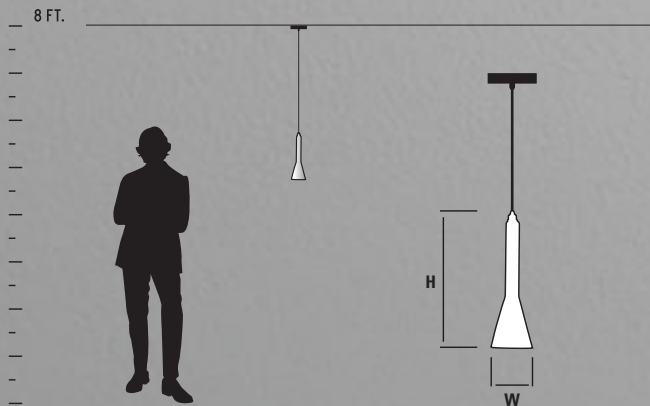



ITEM #	DIFFUSER	FINISH	DIMENSIONS	LAMPING	DRIVER	CERTIFICATION
<b>3-652-14</b>	Clear Glass	14 Polished Chrome	5"(w) x 16.25"(h)*	1 x 6.2w, 90CRI 3000k LED	120/277V 0-10V/Phase dimming	
<b>3-652-1314</b>	13 Smoked Ombre Glass	14 Polished Chrome	5"(w) x 16.25"(h)*	1 x 6.2w, 90CRI 3000k LED	120/277V 0-10V/Phase dimming	
<b>3-652-2018</b>	20 Coffee Ombre Glass	18 Gunmetal	5"(w) x 16.25"(h)*	1 x 6.2w, 90CRI 3000k LED	120/277V 0-10V/Phase dimming	

2700k, 3500k, 4000k color temperatures also available. Visit [oxygenlighting.com](http://oxygenlighting.com)

**GENERAL SPECIFICATIONS:**

• Cold rolled steel canopy. • Blown glass is 1/16" thick. • \*Height measured not including adjustable cord or ceiling canopy. • Fixture supplied with 10' cord. • Unit mounts to 4" octagonal junction box or deep 4"x4" square junction box w/ single device mud ring. • Optional multi-pendant canopies available for 3, 5, and 7 lights. • Unit requires 2.5" deep junction box. • Driver mounts inside junction box. • Total luminaire power 7.1w. • Visit [www.oxygenlighting.com](http://www.oxygenlighting.com) for technical cut sheets. • Oxygen reserves the right to modify designs at any time.

# LOTUS PENDANT

FLOURESCENT



2-6107-24

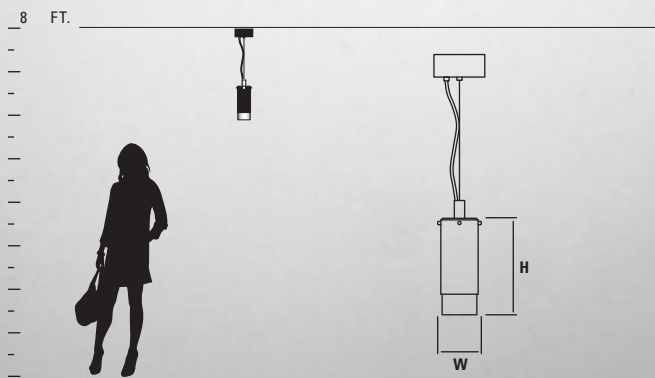

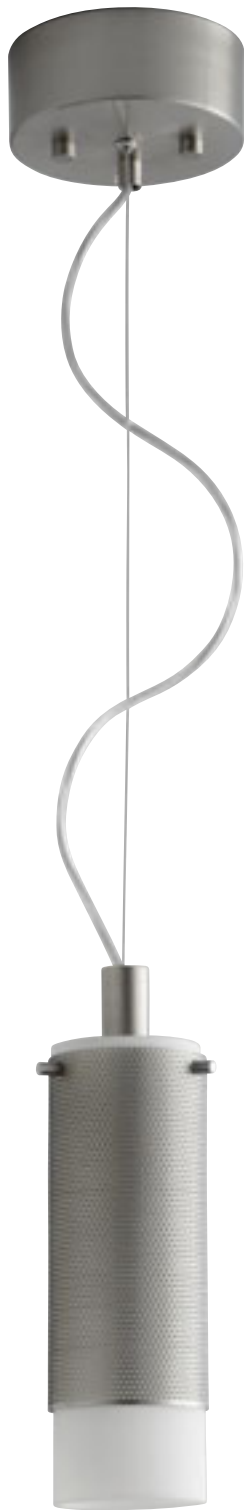

**2-6107-24**

shown with optional perforated sleeve (Included)



**2-6107-24**

ITEM #	DIFFUSER	FINISH	DIMENSIONS	LAMPING	BALLAST	CERTIFICATION
<b>2-6107-24</b>	White Opal Glass	24 Satin Nickel	3.25"(w) x 9.5"(h)*	1 x 13w quad 4-pin fluorescent (G24q-1)	Electronic, HPF, instant start, 120V	

**GENERAL SPECIFICATIONS:**

• Formed steel canopy. • Cold rolled steel housing. • White Opal glass diffuser is 3/16" thick. • \*Height measured not including adjustable cord or ceiling canopy. • Optional perforated sleeve included. • Perforated metal overlay in natural steel finish. • Unit mount to standard 4" octagonal junction box. • To avoid possible abnormal end of life, use lamps with integral End of Life protection. • 10' cord provided. • Visit [www.oxygenlighting.com](http://www.oxygenlighting.com) for technical cut sheets. • Oxygen reserves the right to modify designs at any time.



# LUNA PENDANT

LED



3-670-40

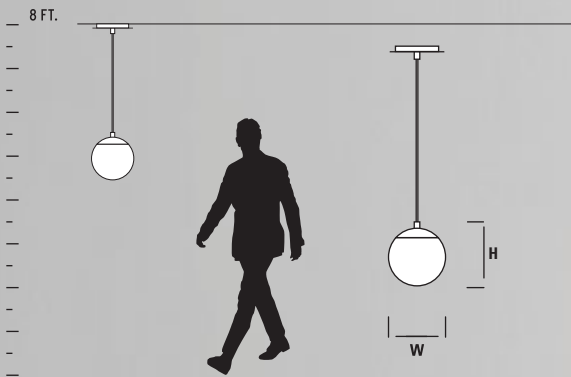



ITEM #	DIFFUSER	FINISH	DIMENSIONS	LAMPING	DRIVER	CERTIFICATION
<b>3-670-XX</b>	Matte Opal Glass	20 Polished Nickel 22 Oiled Bronze 24 Satin Nickel 40 Aged Brass	6"(w) x 8.25"(h)*	1 x 6.2w, 90CRI 3000k LED	120/277V 0-10V/Phase dimming	
<b>3-671-XX</b>	Matte Opal Glass	20 Polished Nickel 22 Oiled Bronze 24 Satin Nickel 40 Aged Brass	8"(w) x 9.5"(h)*	1 x 6.2w, 90CRI 3000k LED	120/277V 0-10V/Phase dimming	
<b>3-672-XX</b>	Matte Opal Glass	20 Polished Nickel 22 Oiled Bronze 24 Satin Nickel 40 Aged Brass	10"(w) x 13"(h)*	1 x 8.2w, 90CRI 3000k LED	120/277V 0-10V/Phase dimming	
<b>3-673-XX</b>	Matte Opal Glass	20 Polished Nickel 22 Oiled Bronze 24 Satin Nickel 40 Aged Brass	12"(w) x 13.75"(h)*	1 x 8.2w, 90CRI 3000k LED	120/277V 0-10V/Phase dimming	

2700k, 3500k, 4000k color temperatures also available. Visit [oxygenlighting.com](http://oxygenlighting.com)

**GENERAL SPECIFICATIONS:**

- Cold rolled steel housing and canopy. • Matte opal glass is 1/8" thick. • \*Height measured not including adjustable cord or ceiling canopy. • Fixture supplied with 10' cord.
- Unit mounts to 4" octagonal junction box or deep 4"x4" square junction box w/ single device mud ring. • Optional multi-pendant canopies available for 3, 5, and 7 lights.
- Unit requires 2.5" deep junction box. • Driver mounts inside junction box. • Total luminaire power 7.1w for 3-670-XX and 3-671-XX, 10.5w for 3-672-XX and 3-673-XX.
- Visit [www.oxygenlighting.com](http://www.oxygenlighting.com) for technical cut sheets. • Oxygen reserves the right to modify designs at any time.

# MAGNETA PENDANT

LED

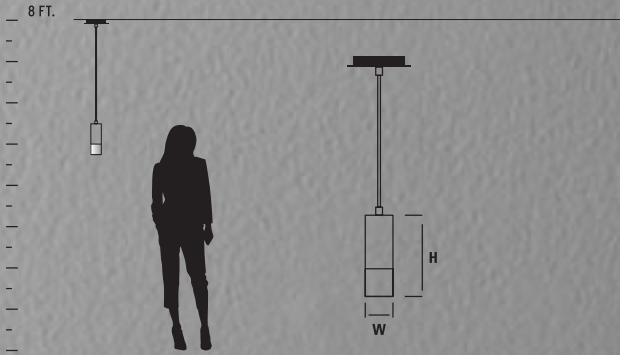
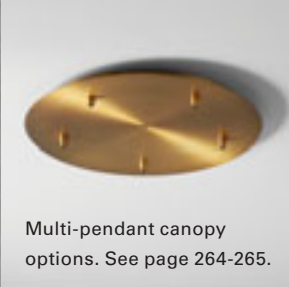



3-607-24



3-607-40



3-607-124

ITEM #	DIFFUSER	FINISH	DIMENSIONS	LAMPING	DRIVER	CERTIFICATION
3-607-XX	Matte White Acrylic	24 Satin Nickel 40 Aged Brass	2.75"(w) x 9.75"(h)	1 x 6.2w, 90CRI 3000k LED	120/277V 0-10V/Phase dimming	ETL US ETL damp
3-607-1XX	1 Matte Opal Glass	24 Satin Nickel 40 Aged Brass	2.75"(w) x 9.75"(h)	1 x 6.2w, 90CRI 3000k LED	120/277V 0-10V/Phase dimming	ETL US ETL damp

**GENERAL SPECIFICATIONS:**

• Cold rolled steel canopy. • Matte white acrylic is 1/16" thick. • Blown glass is 1/8" thick. • \*Height measured not including adjustable cord or ceiling canopy. • Fixture supplied with 10' cord. • Unit mounts to 4" octagonal junction box or deep 4"x4" square junction box w/ single device mud ring. • Unit requires 2.5" deep junction box. • Driver mounts inside junction box. • Optional multi-pendant canopies available for 3, 5, and 7 lights. • Total luminaire power 7.1w. • Visit [www.oxygenlighting.com](http://www.oxygenlighting.com) for technical cut sheets. • Oxygen reserves the right to modify designs at any time.

# MAGNUM PENDANT

LED

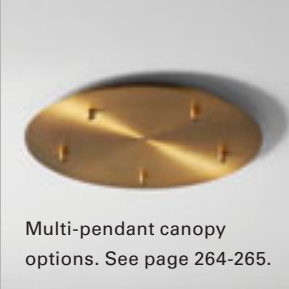

3-653-40

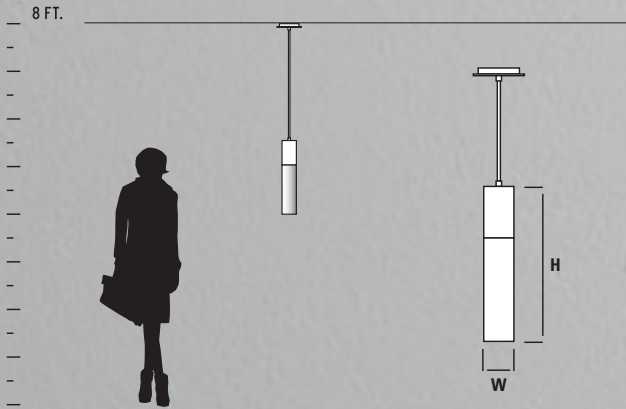





3-653-14



3-653-24



3-653-24

ITEM #	DIFFUSER	FINISH	DIMENSIONS	LAMPING	DRIVER	CERTIFICATION
<b>3-653-XX</b>	Matte White Acrylic	14 Polished Chrome 24 Satin Nickel 40 Aged Brass	3.5"(w) x 18"(h)*	1 x 6.2w, 90CRI 3000k LED	120/277V 0-10V/Phase dimming	
<b>3-653-1XX</b>	<b>1</b> Matte Opal Glass	14 Polished Chrome 24 Satin Nickel 40 Aged Brass	3.5"(w) x 18"(h)*	1 x 6.2w, 90CRI 3000k LED	120/277V 0-10V/Phase dimming	

2700k, 3500k, 4000k color temperatures also available. Visit [oxygenlighting.com](http://oxygenlighting.com)

**GENERAL SPECIFICATIONS:**

• Aluminum housing. • Cold rolled steel canopy. • Matte white acrylic is 1/16" thick. • Blown glass is 1/8" thick. • \*Height measured not including adjustable cord or ceiling canopy. • Fixture supplied with 10' cord. • Unit mounts to 4" octagonal junction box or deep 4"x4" square junction box w/ single device mud ring.. • Unit requires 2.5" deep junction box. • Driver mounts inside junction box. • Optional multi-pendant canopies available for 3, 5, and 7 lights. • Total luminaire power 7.1w. • Visit [www.oxygenlighting.com](http://www.oxygenlighting.com) for technical cut sheets. • Oxygen reserves the right to modify designs at any time.



# OPUS PENDANT



LED

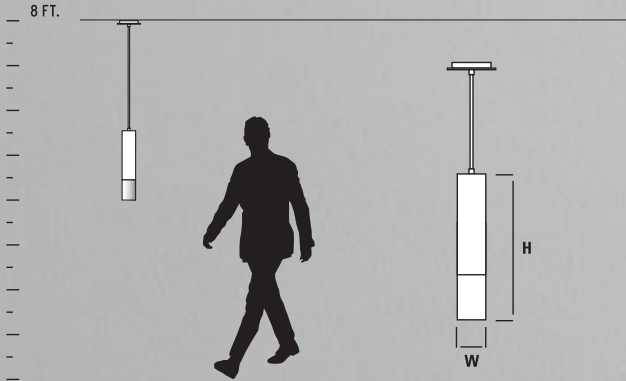

3-654-24





ITEM #	DIFFUSER	FINISH	DIMENSIONS	LAMPING	DRIVER	CERTIFICATION
<b>3-654-XX</b>	Matte White Acrylic	14 Polished Chrome 24 Satin Nickel 25 Satin Copper 40 Aged Brass	3.5"(w) x 18"(h)*	1 x 6.2w, 90CRI 3000k LED	120V 0-10V/Phase dimming	
<b>3-654-1XX</b>	1 Matte Opal Glass	14 Polished Chrome 24 Satin Nickel 25 Satin Copper 40 Aged Brass	3.5"(w) x 18"(h)*	1 x 6.2w, 90CRI 3000k LED	120V 0-10V/Phase dimming	

2700k, 3500k, 4000k color temperatures also available. Visit [oxygenlighting.com](http://oxygenlighting.com)

**GENERAL SPECIFICATIONS:**

- Aluminum housing. • Cold rolled steel canopy. • Matte white acrylic is 1/16" thick. • Blown glass is 1/8" thick. • \*Height measured not including adjustable cord or ceiling canopy. • Fixture supplied with 10' cord. • Unit mounts to 4" octagonal junction box or deep 4"x4" square junction box w/ single device mud ring.. • Unit requires 2.5" deep junction box. • Driver mounts inside junction box. • Optional multi-pendant canopies available for 3, 5, and 7 lights. • Total luminaire power 7.1w.
- Visit [www.oxygenlighting.com](http://www.oxygenlighting.com) for technical cut sheets. • Oxygen reserves the right to modify designs at any time.

# RUVO PENDANT

LED



3-6202-25

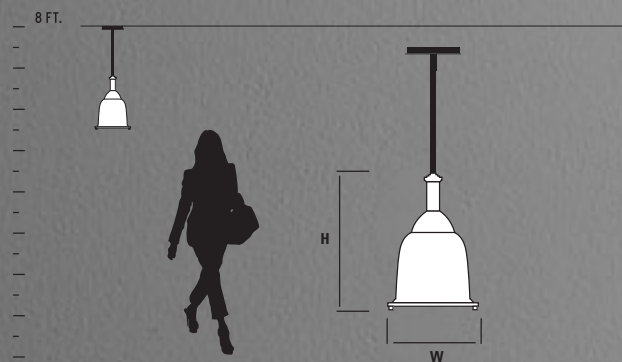



ITEM #	DIFFUSER	FINISH	DIMENSIONS	LAMPING	CERTIFICATION
<b>3-6202-XX</b>	Steel shade with White Tiffany glass	22 Oiled Bronze 24 Satin Nickel 25 Satin Copper	10.5"(w) x 16.5"(h)*	1 x 24w MAX PAR20/30/38, A21,A19 Medium Base 120V LED only (lamp not included)	

**GENERAL SPECIFICATIONS:**

• Cold rolled Steel Canopy. • White Tiffany glass diffuser. • \*Height measured not including stem or ceiling canopy. • Stem is custom cut at oxygen facility to customer's specification (maximum stem length 60"). • Toolless lamp access. • Canopy swivel allows for mounting on sloped ceilings – up to 30-degrees. • Unit mounts to 4" octagonal junction box. • Visit [www.oxygenlighting.com](http://www.oxygenlighting.com) for technical cut sheets. • Oxygen reserves the right to modify designs at any time.

# SPINDLE PENDANT

LED



Multi-pendant canopy options. See page 264-265.



3-656-2018

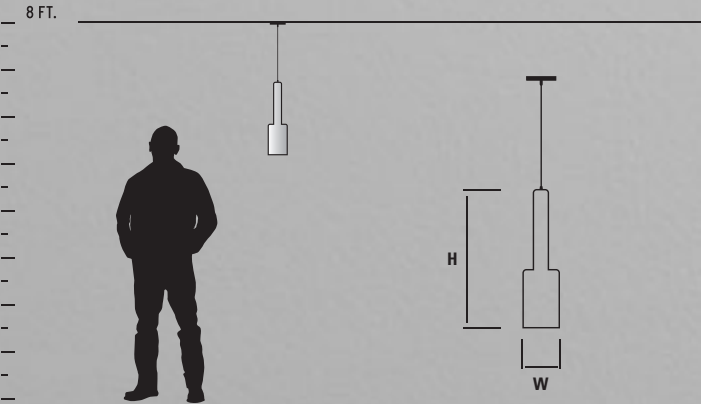



ITEM #	DIFFUSER	FINISH	DIMENSIONS	LAMPING	DRIVER	CERTIFICATION
<b>3-656-14</b>	Clear Glass	14 Polished Chrome	5"(w) x 19"(h)*	1 x 6.2w, 90CRI 3000k LED	120/277V 0-10V/Phase dimming	
<b>3-656-1314</b>	<b>13</b> Smoked Ombre Glass	14 Polished Chrome	5"(w) x 19"(h)*	1 x 6.2w, 90CRI 3000k LED	120/277V 0-10V/Phase dimming	
<b>3-656-2018</b>	<b>20</b> Coffee Ombre Glass	18 Gunmetal	5"(w) x 19"(h)*	1 x 6.2w, 90CRI 3000k LED	120/277V 0-10V/Phase dimming	

2700k, 3500k, 4000k color temperatures also available. Visit [oxygenlighting.com](http://oxygenlighting.com)

**GENERAL SPECIFICATIONS:**

• Cold rolled steel canopy. • Blown glass is 1/16" thick. • \*Height measured not including adjustable cord or ceiling canopy. • Fixture supplied with 10' cord. • Unit mounts to 4" octagonal junction box or deep 4"x4" square junction box w/ single device mud ring. • Unit requires 2.5" deep junction box. • Driver mounts inside junction box. • Optional multi-pendant canopies available for 3, 5, and 7 lights. • Total luminaire power 7.1w. • Visit [www.oxygenlighting.com](http://www.oxygenlighting.com) for technical cut sheets. • Oxygen reserves the right to modify designs at any time.



# VIDA PENDANT

LED



3-6203-22

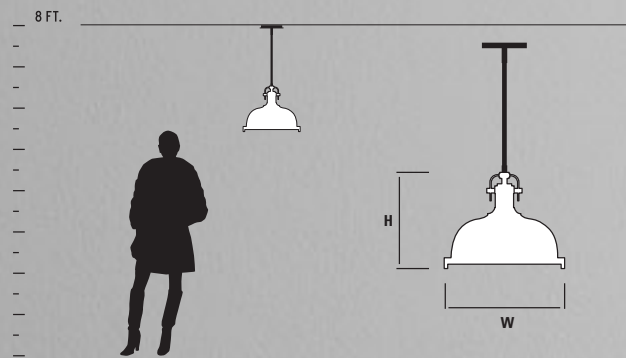



ITEM #	DIFFUSER	FINISH	DIMENSIONS	LAMPING	CERTIFICATION
3-6203-XX	Steel shade with White Tiffany glass	22 Oiled Bronze 24 Satin Nickel	16.5"(w) x 13"(h)*	1 x 24w MAX PAR20/30/38, A21,A19 Medium Base 120V LED only (lamp not included)	 

**GENERAL SPECIFICATIONS:**

- Cold rolled Steel Canopy. • White Tiffany glass diffuser. • \*Height measured not including stem or ceiling canopy. • Stem is custom cut at oxygen facility to customer's specification (maximum stem length 60"). • Toolless lamp access. • Canopy swivel allows for mounting on sloped ceilings – up to 30-degrees. • Unit mounts to 4" octagonal junction box. • Visit [www.oxygenlighting.com](http://www.oxygenlighting.com) for technical cut sheets • Oxygen reserves the right to modify designs at any time.

# ZEPP PENDANT

LED



32-633-15

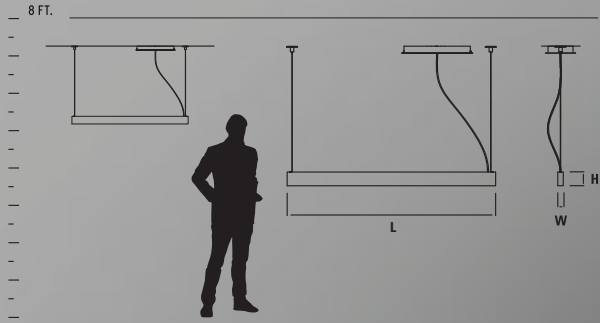





32-632-20



32-632-24

ITEM #	DIFFUSER	FINISH	DIMENSIONS	LAMPING	DRIVER	CERTIFICATION
<b>32-632-XX</b>	Matte White Acrylic	15 Black 20 Polished Nickel 24 Satin Nickel	38"(l) x 1"(w) x 2.5"(h)	1 x 33w, 90CRI 3000k LED	120/277V 0-10V Dimming	
<b>32-633-XX</b>	Matte White Acrylic	15 Black 20 Polished Nickel 24 Satin Nickel	50"(l) x 1"(w) x 2.5"(h)	2 x 25w, 90CRI 3000k LED	120/277V 0-10V Dimming	

2700k, 3500k, 4000k color temperatures also available. Visit [oxygenlighting.com](http://oxygenlighting.com)

**GENERAL SPECIFICATIONS:**

- Cold rolled steel housing and canopy. • \*Height measured not including adjustable cord or ceiling canopy. • Fixture supplied with 10' cord and 12.5' aircraft cable. • Unit mounts to 4" octagonal junction box. • Total luminaire power 38w for 32-632-XX and 56w for 32-633-XX. • Visit [www.oxygenlighting.com](http://www.oxygenlighting.com) for technical cut sheets. • Oxygen reserves the right to modify designs at any time.







# OUTDOOR

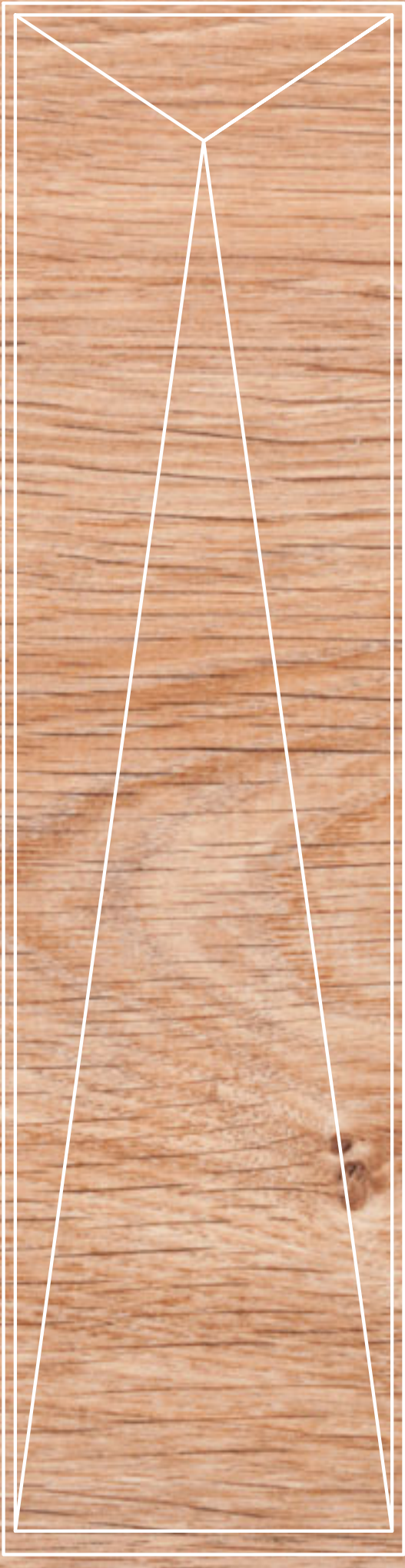



# CALYPSO SCONCE

ADA





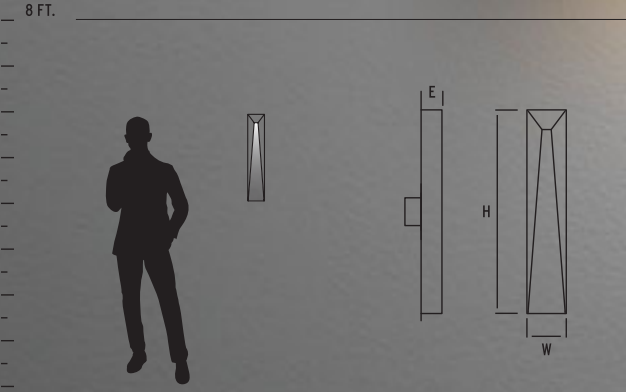

LED



3-730-16





ITEM #	DIFFUSER	FINISH	DIMENSIONS	LAMPING	DRIVER	CERTIFICATION
<b>3-730-XX</b> small	Polished White Polycarbonate	16 Gray 22 Oiled Bronze	4.25"(w) x 16.5"(h) x 2.25"(ext)	1 x 10.1w, 90CRI 3000k LED	120/277V 0-10V/Phase dimming	  
<b>3-731-XX</b> large	Polished White Polycarbonate	16 Gray 22 Oiled Bronze	4.25"(w) x 22"(h) x 2.25"(ext)	2 x 10.1w, 90CRI 3000k LED	120/277V 0-10V/Phase dimming	  

2700k, 3500k, 4000k color temperatures also available. Visit [oxygenlighting.com](http://oxygenlighting.com)

**GENERAL SPECIFICATIONS:**

- Cast aluminum housing.
- Matte white polycarbonate diffuser is 1/16" thick.
- Unit mounts to deep 4" octagonal or deep 4"x4" junction box w/ horizontally mounted single device mud ring.
- Driver mounts inside junction box.
- Unit requires 2.5" deep junction box.
- Approved for wall mount applications.
- Total luminaire power 13w for 3-730-XX and 25.9w for 3-731-XX.
- Visit [www.oxygenlighting.com](http://www.oxygenlighting.com) for technical cut sheets.
- Oxygen reserves the right to modify designs at any time.

# CERES SCONCE



LED

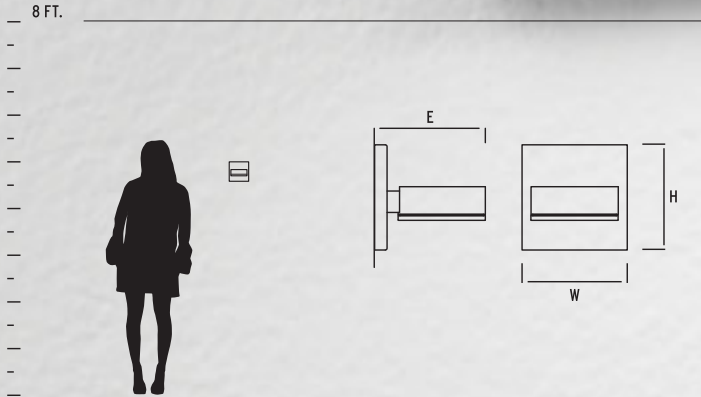

3-727-22





ITEM #	DIFFUSER	FINISH	DIMENSIONS	LAMPING	DRIVER	CERTIFICATION
<b>3-726-XX</b>	Frosted Glass	16 Gray 22 Oiled Bronze	4.75"(w) x 4.75"(h) x 5"(ext)	1 x 8.2w, 90CRI 3000k LED	120/277V 0-10V/Phase dimming	
<b>3-727-XX</b>	Frosted Glass	16 Gray 22 Oiled Bronze	4.75"(w) x 4.75"(h) x 5"(ext)	2 x 8.2w, 90CRI 3000k LED	120/277V 0-10V/Phase dimming	

2700k, 3500k, 4000k color temperatures also available. Visit [oxygenlighting.com](http://oxygenlighting.com)

**GENERAL SPECIFICATIONS:**

• Cast aluminum housing. • Frosted glass lenses. • Unit mounts to deep 4" octagonal or deep 4"x4" junction box. • Driver mounts inside junction box. • Unit requires 2.5" deep junction box. • Approved for wall mount application only. • Approved for vertical and horizontal wall mount applications. • Total luminaire power 10.3w for 3-726-XX and 20.5w for 3-727-XX. • Visit [www.oxygenlighting.com](http://www.oxygenlighting.com) for technical cut sheets. • Oxygen reserves the right to modify designs at any time.

# DUO SCONCE

ADA





LED

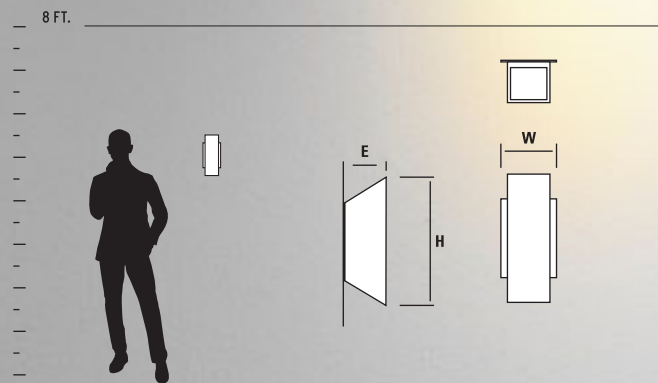

3-703-16





ITEM #	DIFFUSER	FINISH	DIMENSIONS	LAMPING	DRIVER	CERTIFICATION
<b>3-702-XX</b> small	Frosted Glass	16 Gray 22 Oiled Bronze	5.25"(w) x 12.125"(h) x 4"(ext)	2 x 8.4w, 90CRI 3000k LED	120/277V 0-10V/Phase dimming	  
<b>3-703-XX</b> large	Frosted Glass	16 Gray 22 Oiled Bronze	6"(w) x 14"(h) x 6"(ext)	2 x 8.4w, 90CRI 3000k LED	120/277V 0-10V/Phase dimming	 

2700k, 3500k, 4000k color temperatures also available. Visit [oxygenlighting.com](http://oxygenlighting.com)

**GENERAL SPECIFICATIONS:**

- Cast aluminum housing. • Frosted glass lenses. • 3-702-XX mounts to 4" octagonal junction box. • 3-703-XX mounts to 4" octagonal junction box w/ horizontally mounted single device mud ring. • Approved for wall mount applications only. • Total luminaire power 20.3w for 3-702-XX and 20.5w for 3-703-XX. • Visit [www.oxygenlighting.com](http://www.oxygenlighting.com) for technical cut sheets. • Oxygen reserves the right to modify designs at any time.



# ELIF SCONCE

ADA





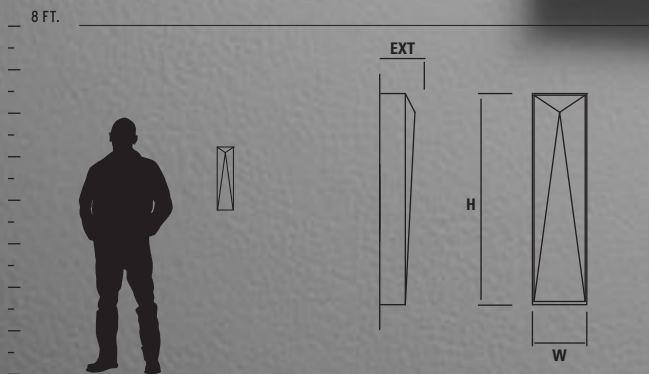

LED



3-736-16





ITEM #	DIFFUSER	FINISH	DIMENSIONS	LAMPING	DRIVER	CERTIFICATION
<b>3-736-XX</b> small	Polished White Polycarbonate	16 Gray 22 Oiled Bronze	4.25"(w) x 16.5"(h) x 2.75"(ext)	1 x 10.1w, 90CRI 3000k LED	120/277V 0-10V/Phase dimming	  
<b>3-737-XX</b> large	Polished White Polycarbonate	16 Gray 22 Oiled Bronze	4.25"(w) x 22"(h) x 2.75"(ext)	2 x 10.1w, 90CRI 3000k LED	120/277V 0-10V/Phase dimming	  

2700k, 3500k, 4000k color temperatures also available. Visit [oxygenlighting.com](http://oxygenlighting.com)

**GENERAL SPECIFICATIONS:**

- Cast aluminum housing. • Matte white polycarbonate diffuser is 1/16" thick. • Unit mounts to deep 4" octagonal or deep 4"x4" junction box. • Driver mounts inside junction box.
- Unit requires 2.5" deep junction box. • Approved for wall mount applications. • Total luminaire power 13w for 3-736-XX and 25.7w for 3-737-XX. • Visit [www.oxygenlighting.com](http://www.oxygenlighting.com) for technical cut sheets. • Oxygen reserves the right to modify designs at any time.

# ERIS SCONCE

ADA

LED







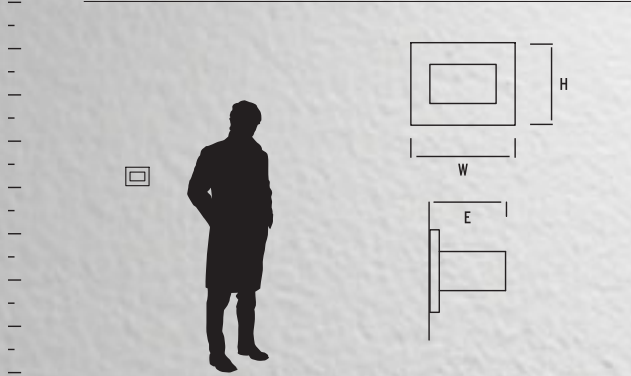

3-721-16

8 FT.





ITEM #	DIFFUSER	FINISH	DIMENSIONS	LAMPING	DRIVER	CERTIFICATION
<b>3-720-XX</b>	Frosted Glass	16 Gray 22 Oiled Bronze	6"(w) x 4.75"(h) x 4"(ext)	1 x 8.2w, 90CRI 3000k LED	120/277V 0-10V/Phase dimming	  
<b>3-721-XX</b>	Frosted Glass	16 Gray 22 Oiled Bronze	6"(w) x 4.75"(h) x 4"(ext)	2 x 8.2w, 90CRI 3000k LED	120/277V 0-10V/Phase dimming	  

2700k, 3500k, 4000k color temperatures also available. Visit [oxygenlighting.com](http://oxygenlighting.com)

**GENERAL SPECIFICATIONS:**

- Cast aluminum housing. • Frosted glass lenses. • Unit mounts to deep 4" octagonal or deep 4"x4" junction box. • Driver mounts inside junction box. • Unit requires 2.5" deep junction box. • Approved for wall mount application only. • Approved for horizontal or vertical mounting. • Total luminaire power 10.4w for 3-720-XX and 20.3w for 3-721-XX.
- Visit [www.oxygenlighting.com](http://www.oxygenlighting.com) for technical cut sheets. • Oxygen reserves the right to modify designs at any time.

# KARME SCONCE

ADA

LED



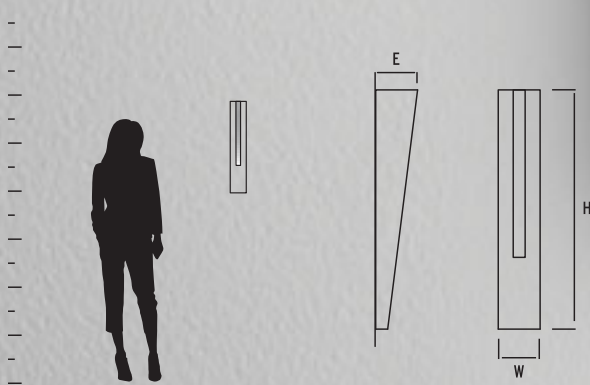

3-739-16

8 FT.





**3-739-22**

ITEM #	DIFFUSER	FINISH	DIMENSIONS	LAMPING	DRIVER	CERTIFICATION
<b>3-739-XX</b>	Matte White Acrylic	16 Gray 22 Oiled Bronze	3.5"(w) x 20"(h) x 3.5"(ext)	1 x 11.9w, 90CRI 3000k LED	120/277V 0-10V/Phase dimming	  

2700k, 3500k, 4000k color temperatures also available. Visit [oxygenlighting.com](http://oxygenlighting.com)

**GENERAL SPECIFICATIONS:**

- Cast aluminum housing. • Matte white polycarbonate diffuser is 1/16" thick. • Matte white acrylic lense • Unit mounts to deep 4"x4" junction box w/ single device mud ring.
- Driver mounts inside junction box. • Unit requires 2.5" deep junction box. • Approved for wall mount applications. • Total luminaire power15.3w. • Visit [www.oxygenlighting.com](http://www.oxygenlighting.com) for technical cut sheets. • Oxygen reserves the right to modify designs at any time.



# LEDA SCONCE

LED

EM



3-713-222

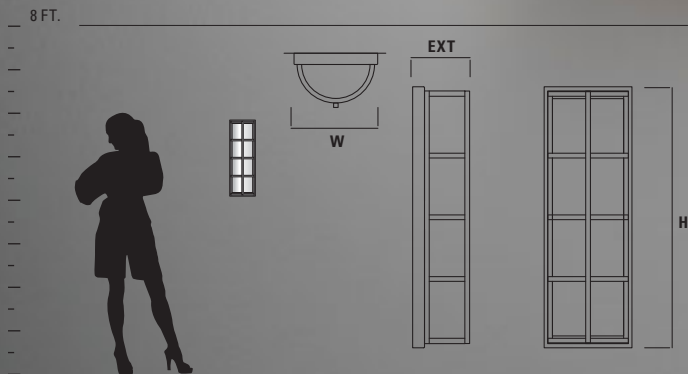



ITEM #	DIFFUSER	FINISH	DIMENSIONS	LAMPING	BALLAST	DRIVER	CERTIFICATION
<b>3-712-2XX</b> small	Matte White Acrylic	22 Oiled Bronze 24 Satin Nickel	7.25"(w) x 16.5"(h) x 4.75"(ext)	1 x 10.1w, 90CRI 3000k LED	--	120/277V 0-10V/Phase dimming	
<b>3-712-2XX-EM</b> small	Matte White Acrylic	22 Oiled Bronze 24 Satin Nickel	7.25"(w) x 16.5"(h) x 4.75"(ext)	1 x 10.1w, 90CRI 3000k LED	--	120/277V 0-10V/Phase dimming	
<b>3-713-2XX</b> large	Matte White Acrylic	22 Oiled Bronze 24 Satin Nickel	7.25"(w) x 21.75"(h) x 4.75"(ext)	2 x 10.1w, 90CRI 3000k LED	--	120/277V 0-10V/Phase dimming	
<b>3-713-2XX-EM</b> large	Matte White Acrylic	22 Oiled Bronze 24 Satin Nickel	7.25"(w) x 21.75"(h) x 4.75"(ext)	2 x 10.1w, 90CRI 3000k LED	--	120/277V 0-10V/Phase dimming	

2700k, 3500k, 4000k color temperatures also available for non EM LED models. Visit [oxygenlighting.com](http://oxygenlighting.com)

**GENERAL SPECIFICATIONS:**

Stainless steel housing. • White acrylic diffuser is extruded 1/8" thick. • Unit mounts to 4" octagonal junction box. • Approved for wall mount application only. • Approved for vertical mounting only. • Total luminaire power 13w for 3-712-XX and 26w for 3-713-XX. • Visit [www.oxygenlighting.com](http://www.oxygenlighting.com) for technical cut sheets. • Oxygen reserves the right to modify designs at any time.

**EMERGENCY BATTERY BACKUP MODELS (EM)**

• ETL required 90 minute emergency battery run time • 32 hour recharge time.

# MAGNETA SCONCE

ADA



LED

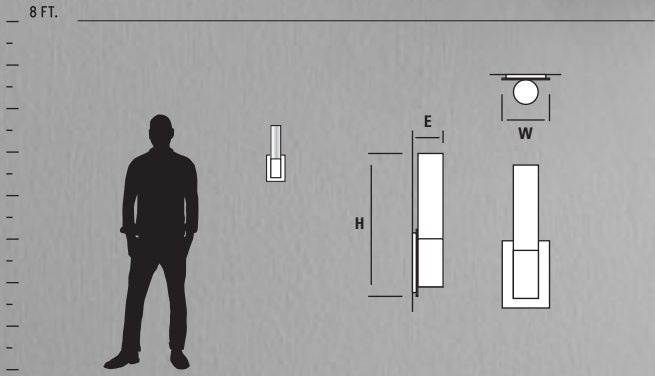

3-728-16





ITEM #	DIFFUSER	FINISH	DIMENSIONS	LAMPING	DRIVER	CERTIFICATION
<b>3-728-XX</b>	Matte Opal Glass	15 Black 16 Gray 22 Oiled Bronze	4.75"(w) x 14.5"(h) x 3.5"(ext)	1 x 11.9w, 90CRI 3000k LED	120/277V 0-10V/Phase dimming	  

2700k, 3500k, 4000k color temperatures also available. Visit [oxygenlighting.com](http://oxygenlighting.com)

**GENERAL SPECIFICATIONS:**

- Cast aluminum housing • Diffuser is 1/8" thick matte opal glass. • Unit mounts to deep 4" octagonal junction box. • Driver mounts inside junction box. • Unit requires 2.5" deep junction box. • Approved for wall mount application only. • Total luminaire power 15.2w. • Visit [www.oxygenlighting.com](http://www.oxygenlighting.com) for technical cut sheets. • Oxygen reserves the right to modify designs at any time.

# MAIA SCONCE

ADA





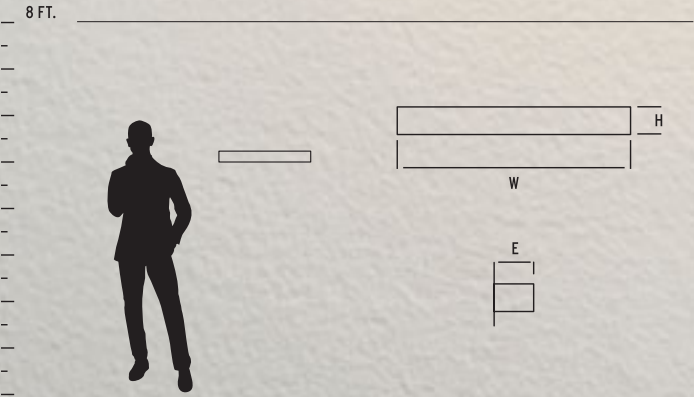

LED



3-740-22  
shown with optional cover plate (included)





ITEM #	DIFFUSER	FINISH	DIMENSIONS	LAMPING	DRIVER	CERTIFICATION
<b>3-740-XX</b> small	Matte White Acrylic	16 Gray 22 Oiled Bronze	11"(w) x 5"(h) x 4"(ext) w/ optional cover plate	1 x 10.1w, 90CRI 3000k LED	120/277V 0-10V/Phase dimming	  
<b>3-742-XX</b> large	Matte White Acrylic	16 Gray 22 Oiled Bronze	24"(w) x 5"(h) x 4"(ext) w/ optional cover plate	2 x 11.9w, 90CRI 3000k LED	120/277V 0-10V/Phase dimming	  

2700k, 3500k, 4000k color temperatures also available. Visit [oxygenlighting.com](http://oxygenlighting.com)

**GENERAL SPECIFICATIONS:**

- Cast aluminum housing. • Matte white polycarbonate diffuser • Unit mounts to deep 4" octagonal or deep 4"x4" junction box w/ single device mud ring. • Driver mounts inside junction box. • Unit requires 2.5" deep junction box. • Mounts to 4" octagonal junction box with optional cover plate. • Approved for vertical and horizontal wall mount applications. • Total luminaire power 13w for 3-740-XX and 30.3 for 3-742-XX. • Visit [www.oxygenlighting.com](http://www.oxygenlighting.com) for technical cut sheets. • Oxygen reserves the right to modify designs at any time.



# REALM SCONCE

LED



3-750-22

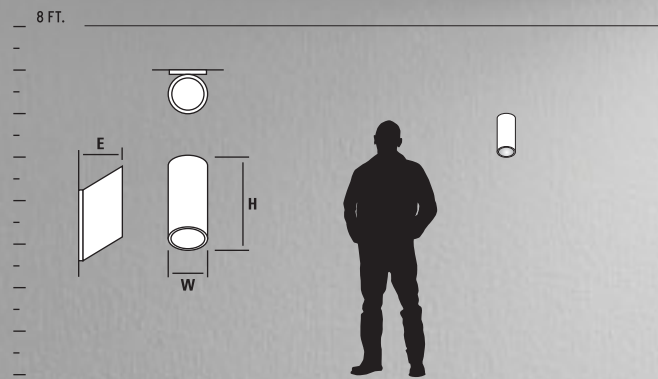



**3-750-16**

ITEM #	DIFFUSER	FINISH	DIMENSIONS	LAMPING	DRIVER	CERTIFICATION
<b>3-750-XX</b>	Frosted Glass	<b>16</b> Gray <b>22</b> Oiled Bronze	5"(w) x 12"(h) x 5.5"(ext)	2 x 8.4w, 90CRI 3000k LED	120/277V 0-10V/Phase dimming	

2700k, 3500k, 4000k color temperatures also available. Visit [oxygenlighting.com](http://oxygenlighting.com)

**GENERAL SPECIFICATIONS:**

- Cast aluminum housing. • Frosted glass lenses. • Unit mounts to 4" octagonal junction box. • Approved for wall mount application only. • Total luminaire power 20.5w.
- [www.oxygenlighting.com](http://www.oxygenlighting.com) for technical cut sheets. • Oxygen reserves the right to modify designs at any time.

# REGIO SCONCE

ADA

LED



3-719-16

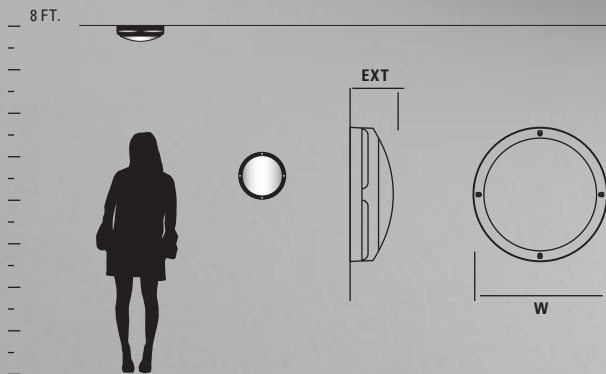



3-719-16



3-719-15

ITEM #	DIFFUSER	FINISH	DIMENSIONS	LAMPING	DRIVER	CERTIFICATION
3-719-XX	Polished White Polycarbonate	15 Black 16 Gray	13"(w) x 4.25"(ext)	2 x 10.1w, 90CRI 3000k LED	120/277V 0-10V/Phase dimming	

2700k, 3500k, 4000k color temperatures also available. Visit [oxygenlighting.com](http://oxygenlighting.com)

**GENERAL SPECIFICATIONS:**

- Cast aluminum housing.
- Injected molded polycarbonate diffuser.
- Captive, stainless steel, tamper resistant hardware.
- Vandal resistant construction.
- Unit mounts to 4" octagonal junction box.
- Approved for wall or ceiling mount applications.
- Total luminaire power 26.2w.
- Visit [www.oxygenlighting.com](http://www.oxygenlighting.com) for technical cut sheets.
- Oxygen reserves the right to modify designs at any time.

# SCOPE SCONCE

LED



3-752-16

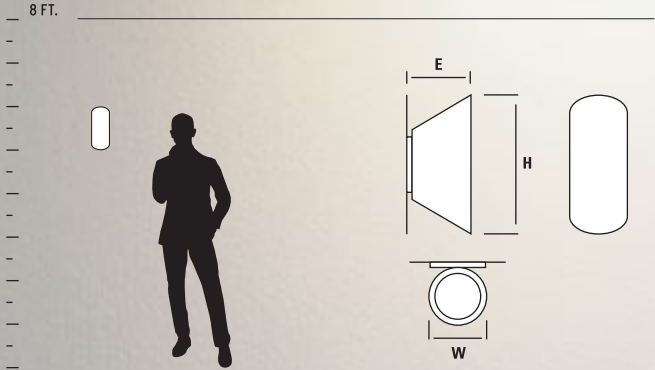



**3-752-22**

ITEM #	DIFFUSER	FINISH	DIMENSIONS	LAMPING	DRIVER	CERTIFICATION
<b>3-752-XX</b>	Frosted Glass	16 Gray 22 Oiled Bronze	5"(w) x 12"(h) x 5.5"(ext)	2 x 8.4w, 90CRI 3000k LED	120/277V 0-10V/Phase dimming	

2700k, 3500k, 4000k color temperatures also available. Visit [oxygenlighting.com](http://oxygenlighting.com)

**GENERAL SPECIFICATIONS:**

- Cast aluminum housing. • Frosted white lenses. • Unit mounts to 4" octagonal junction box. • Approved for wall mount application only. • Total luminaire power 20.5w.
- Visit [www.oxygenlighting.com](http://www.oxygenlighting.com) for technical cut sheets. • Oxygen reserves the right to modify designs at any time.



# TELSHOR SCONCE

LED

EM



3-711-224





ITEM #	DIFFUSER	FINISH	DIMENSIONS	LAMPING	DRIVER	CERTIFICATION
<b>3-710-2XX</b> small	2 Matte White Acrylic	22 Oiled Bronze 24 Satin Nickel	7.25"(w) x 16.5"(h) x 5"(ext)	1 x 10.1W, 90CRI 3000k LED	120/277V 0-10V/Phase dimming	
<b>3-710-2XX-EM</b> small	2 Matte White Acrylic	22 Oiled Bronze 24 Satin Nickel	7.25"(w) x 16.5"(h) x 5"(ext)	1 x 10.1W, 90CRI 3000k LED	120/277V 0-10V/Phase dimming	
<b>3-711-2XX</b> large	2 Matte White Acrylic	22 Oiled Bronze 24 Satin Nickel	9"(w) x 21.75"(h) x 5"(ext)	2 x 10.1W, 90CRI 3000k LED	120/277V 0-10V/Phase dimming	
<b>3-711-2XX-EM</b> large	2 Matte White Acrylic	22 Oiled Bronze 24 Satin Nickel	9"(w) x 21.75"(h) x 5"(ext)	2 x 10.1W, 90CRI 3000k LED	120/277V 0-10V/Phase dimming	

2700k, 3500k, 4000k color temperatures also available for non EM LED models. Visit [oxygenlighting.com](http://oxygenlighting.com)

**GENERAL SPECIFICATIONS:**

• Stainless steel housing. • White acrylic diffuser is formed 1/8" thick. • Unit mounts to 4" octagonal junction box. • Approved for wall mount application only. • Approved for vertical mounting only. • Total luminaire power 13w for 3-710-XX and 26w for 3-711-XX. • Visit [www.oxygenlighting.com](http://www.oxygenlighting.com) for technical cut sheets. • Oxygen reserves the right to modify designs at any time.

**EMERGENCY BATTERY BACKUP MODELS (EM)**

• ETL required 90 minute emergency battery run time • 32 hour recharge time.

# UNO SCONCE

ADA





LED

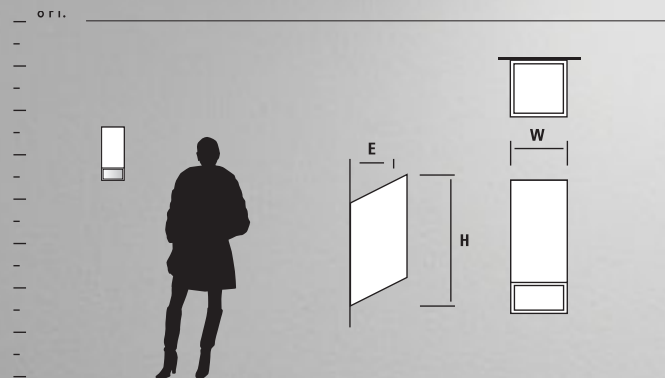

3-701-16





ITEM #	DIFFUSER	FINISH	DIMENSIONS	LAMPING	DRIVER	CERTIFICATION
<b>3-700-XX</b> small	Frosted Glass	16 Gray 22 Oiled Bronze	5.25"(w) x 9.25"(h) x 4"(ext)	1 x 8.4w, 90CRI 3000k LED	120/277V 0-10V/Phase dimming	  
<b>3-701-XX</b> large	Frosted Glass	16 Gray 22 Oiled Bronze	6"(w) x 14"(h) x 6"(ext)	2 x 8.4w, 90CRI 3000k LED	120/277V 0-10V/Phase dimming	 

2700k, 3500k, 4000k color temperatures also available. Visit [oxygenlighting.com](http://oxygenlighting.com)

**GENERAL SPECIFICATIONS:**

- Cast aluminum housing.
- Frosted glass lenses.
- 3-700-XX mounts to 4" octagonal junction box.
- 3-701-XX mounts to 4" octagonal junction box.
- Approved for wall mount application only.
- Total luminaire power 10.3w for 3-700-XX and 20.5w for 3-701-XX.
- Visit [www.oxygenlighting.com](http://www.oxygenlighting.com) for technical cut sheets.
- Oxygen reserves the right to modify designs at any time.



# ACCESSORIES





# ACCESSORIES

## GENERAL SPECIFICATIONS:

Multi-pendant canopies are available in assorted configurations that are compatible with the following pendant designs to create a stunning visual display.

• Cornet • Ellipse • Galaxy • Gratis • Idol • Liberty • Luna • Magneta • Magnum • Opus • Spindle





**POLISHED CHROME**

- 3-8-6714** - 7 light - 20.75"(w) x 2.25"(h)
- 3-8-6514** - 5 light - 19"(w) x 2.25"(h) (shown)
- 3-8-6314** - 3 light - 13.125"(w) x 2.25"(h)



**POLISHED CHROME**

- 3-8-7514** - 5 light - 48"(l) x 5.5"(w) x 1.875"(h) (shown)
- 3-8-7314** - 3 light - 36"(l) x 5.5"(w) x 1.875"(h)
- 3-8-7214** - 2 light - 24"(l) x 5.5"(w) x 1.875"(h)



**GUNMETAL**

- 3-8-6718** - 7 light - 20.75"(w) x 2.25"(h) (shown)
- 3-8-6518** - 5 light - 19"(w) x 2.25"(h)
- 3-8-6318** - 3 light - 13.125"(w) x 2.25"(h)



**GUNMETAL**

- 3-8-7518** - 5 light - 48"(l) x 5.5"(w) x 1.875"(h)
- 3-8-7318** - 3 light - 36"(l) x 5.5"(w) x 1.875"(h) (shown)
- 3-8-7218** - 2 light - 24"(l) x 5.5"(w) x 1.875"(h)



**SATIN NICKEL**

- 3-8-6724** - 7 light - 20.75"(w) x 2.25"(h) (shown)
- 3-8-6524** - 5 light - 19"(w) x 2.25"(h)
- 3-8-6324** - 3 light - 13.125"(w) x 2.25"(h)



**SATIN NICKEL**

- 3-8-7524** - 5 light - 48"(l) x 5.5"(w) x 1.875"(h)
- 3-8-7324** - 3 light - 36"(l) x 5.5"(w) x 1.875"(h)
- 3-8-7224** - 2 light - 24"(l) x 5.5"(w) x 1.875"(h) (shown)



**AGED BRASS**

- 3-8-6740** - 7 light - 20.75"(w) x 2.25"(h)
- 3-8-6540** - 5 light - 19"(w) x 2.25"(h)
- 3-8-6340** - 3 light - 13.125"(w) x 2.25"(h) (shown)



**AGED BRASS**

- 3-8-7540** - 5 light - 48"(l) x 5.5"(w) x 1.875"(h) (shown)
- 3-8-7340** - 3 light - 36"(l) x 5.5"(w) x 1.875"(h)
- 3-8-7240** - 2 light - 24"(l) x 5.5"(w) x 1.875"(h)

# ACCESSORIES

## OPTIONAL 1/2" DOWNRODS

These downrods allow you to choose how far your fan will hang from the ceiling. We offer a complete line of extension rods to match oxygen finishes. Remember your fan should always hang at least 7 feet above the floor.

DOWNROD FINISH	12"	18"	24"	36"	48"	60"	72"
White	3-6-1206	3-6-1806	3-6-2406	3-6-3606	3-6-4806	3-6-6006	3-6-7206
Black	3-6-1215	3-6-1815	3-6-2415	3-6-3615	3-6-4815	3-6-6015	3-6-7215
Polished Nickel	3-6-1220	3-6-1820	3-6-2420	3-6-3620	3-6-4820	3-6-6020	3-6-7220
Oiled Bronze	3-6-1222	3-6-1822	3-6-2422	3-6-3622	3-6-4822	3-6-6022	3-6-7222
Satin Nickel	3-6-1224	3-6-1824	3-6-2424	3-6-3624	3-6-4824	3-6-6024	3-6-7224



DIFFUSERS



white opal glass



matte white acrylic



smoked ombre glass



coffee ombre glass



clear glass



white glass



mirrored glass

FINISHES



6 - white



14 - polished chrome



15 - black



16 - gray



18 - gunmetal



20 - polished nickel

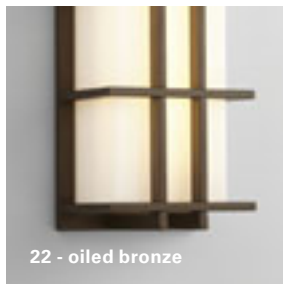

22 - oiled bronze



24 - satin nickel



25 - satin copper

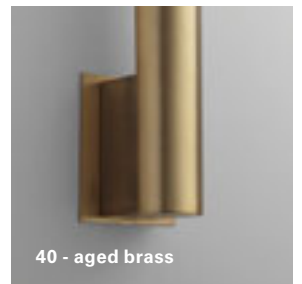

40 - aged brass

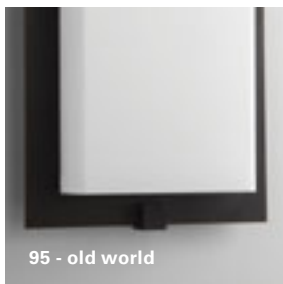

95 - old world

# INDEX

item #. . . . . pg #	item #. . . . . pg #	item #. . . . . pg #	item #. . . . . pg #
2-597-124 . . . . . 43	3-6-2422 . . . . . 266	3-8-7240 . . . . . 265	3-105-06 . . . . . 19
2-597-224 . . . . . 43	3-6-2424 . . . . . 266	3-8-7314 . . . . . 265	3-105-022 . . . . . 19
2-699-24 . . . . . 171	3-6-3606 . . . . . 266	3-8-7318 . . . . . 265	3-105-024 . . . . . 19
2-5104-14 . . . . . 121	3-6-3615 . . . . . 266	3-8-7324 . . . . . 265	3-106-6 . . . . . 29
2-5104-24 . . . . . 121	3-6-3620 . . . . . 266	3-8-7340 . . . . . 265	3-106-22 . . . . . 29
2-5105-14 . . . . . 121	3-6-3622 . . . . . 266	3-8-7514 . . . . . 265	3-106-24 . . . . . 29
2-5105-24 . . . . . 121	3-6-3624 . . . . . 266	3-8-7518 . . . . . 265	3-107-6 . . . . . 33
2-5106-14 . . . . . 121	3-6-4806 . . . . . 266	3-8-7524 . . . . . 265	3-107-15 . . . . . 33
2-5106-24 . . . . . 121	3-6-4815 . . . . . 266	3-8-7540 . . . . . 265	3-107-24 . . . . . 33
2-5107-24 . . . . . 39	3-6-4820 . . . . . 266	3-8-61306 . . . . . 19	3-308-115 . . . . . 187
2-5121-114. . . . . 147	3-6-4822 . . . . . 266	3-8-61322 . . . . . 19	3-308-120 . . . . . 187
2-5121-124 . . . . . 147	3-6-4824 . . . . . 266	3-8-61324 . . . . . 19	3-308-124 . . . . . 187
2-5131-14 . . . . . 151	3-6-6006 . . . . . 266	3-100-6 . . . . . 23	3-308-215 . . . . . 187
2-5131-24 . . . . . 151	3-6-6015 . . . . . 266	3-100-15 . . . . . 23	3-308-220 . . . . . 187
2-5132-14 . . . . . 151	3-6-6020 . . . . . 266	3-100-20 . . . . . 23	3-308-224 . . . . . 187
2-5132-24 . . . . . 151	3-6-6022 . . . . . 266	3-100-22 . . . . . 23	3-309-115 . . . . . 187
2-5134-24 . . . . . 135	3-6-6024 . . . . . 266	3-100-24 . . . . . 23	3-309-120 . . . . . 187
2-5154-124 . . . . . 57	3-6-7206 . . . . . 266	3-101-6 . . . . . 25	3-309-124 . . . . . 187
2-5154-224 . . . . . 57	3-6-7215 . . . . . 266	3-101-15. . . . . 25	3-309-215 . . . . . 187
2-5156-124 . . . . . 85	3-6-7220 . . . . . 266	3-101-20 . . . . . 25	3-309-220 . . . . . 187
2-5170-224 . . . . . 117	3-6-7222 . . . . . 266	3-101-22 . . . . . 25	3-309-224 . . . . . 187
2-6107-24 . . . . . 215	3-6-7224 . . . . . 266	3-101-24 . . . . . 25	3-353-115 . . . . . 169
2-6138-6 . . . . . 193	3-8-6314 . . . . . 265	3-102-6 . . . . . 27	3-353-120 . . . . . 169
2-6139-6 . . . . . 193	3-8-6318 . . . . . 265	3-102-15 . . . . . 27	3-353-124 . . . . . 169
3-6-1206 . . . . . 266	3-8-6324 . . . . . 265	3-102-20 . . . . . 27	3-353-215 . . . . . 169
3-6-1215 . . . . . 266	3-8-6340 . . . . . 265	3-102-22 . . . . . 27	3-353-220 . . . . . 169
3-6-1220 . . . . . 266	3-8-6514 . . . . . 265	3-102-24 . . . . . 27	3-353-224 . . . . . 169
3-6-1222 . . . . . 266	3-8-6518 . . . . . 265	3-103-6 . . . . . 21	3-354-115 . . . . . 169
3-6-1224 . . . . . 266	3-8-6524 . . . . . 265	3-103-15 . . . . . 21	3-354-120 . . . . . 169
3-6-1806 . . . . . 266	3-8-6540 . . . . . 265	3-103-20 . . . . . 21	3-354-124 . . . . . 169
3-6-1815 . . . . . 266	3-8-6714 . . . . . 265	3-103-22 . . . . . 21	3-354-215 . . . . . 169
3-6-1820 . . . . . 266	3-8-6718 . . . . . 265	3-103-24 . . . . . 21	3-354-220 . . . . . 169
3-6-1822 . . . . . 266	3-8-6724 . . . . . 265	3-104-6 . . . . . 31	3-354-224 . . . . . 169
3-6-1824 . . . . . 266	3-8-6740 . . . . . 265	3-104-15 . . . . . 31	3-500-18 . . . . . 99
3-6-2406 . . . . . 266	3-8-7214 . . . . . 265	3-104-20 . . . . . 31	3-500-24 . . . . . 99
3-6-2415 . . . . . 266	3-8-7218 . . . . . 265	3-104-22 . . . . . 31	3-500-40 . . . . . 99
3-6-2420 . . . . . 266	3-8-7224 . . . . . 265	3-104-24 . . . . . 31	3-504-14 . . . . . 91

item #. . . . . pg #	item #. . . . . pg #	item #. . . . . pg #	item #. . . . . pg #
3-504-24 . . . . . 91	3-521-24 . . . . . 47	3-535-40 . . . . . 61	3-553-20 . . . . . 45
3-504-25 . . . . . 91	3-521-40 . . . . . 47	3-536-22 . . . . . 117	3-553-24 . . . . . 45
3-504-40 . . . . . 91	3-522-24 . . . . . 87	3-536-24 . . . . . 117	3-556-14 . . . . . 109
3-509-18 . . . . . 53	3-522-24-EM . . . . . 87	3-536-40 . . . . . 117	3-556-22 . . . . . 109
3-509-24 . . . . . 53	3-523-224 . . . . . 83	3-537-22 . . . . . 117	3-556-24 . . . . . 109
3-509-40 . . . . . 53	3-523-224-EM . . . . . 83	3-537-24 . . . . . 117	3-556-40 . . . . . 109
3-511-14 . . . . . 63	3-523-295 . . . . . 83	3-537-40 . . . . . 117	3-557-14 . . . . . 159
3-511-22 . . . . . 63	3-523-295-EM . . . . . 83	3-538-22 . . . . . 77	3-557-22 . . . . . 159
3-511-24 . . . . . 63	3-524-14 . . . . . 123	3-538-24 . . . . . 77	3-557-24 . . . . . 159
3-511-40 . . . . . 63	3-524-22 . . . . . 123	3-539-22 . . . . . 79	3-557-40 . . . . . 159
3-512-24 . . . . . 51	3-524-24 . . . . . 123	3-539-24 . . . . . 79	3-559-14 . . . . . 159
3-513-24 . . . . . 51	3-525-14 . . . . . 123	3-540-14 . . . . . 81	3-559-22 . . . . . 159
3-514-14 . . . . . 49	3-525-22 . . . . . 123	3-540-24 . . . . . 81	3-559-24 . . . . . 159
3-514-22 . . . . . 49	3-525-24 . . . . . 123	3-540-40 . . . . . 81	3-559-40 . . . . . 159
3-514-24 . . . . . 49	3-526-14 . . . . . 123	3-541-20 . . . . . 71	3-560-22 . . . . . 107
3-514-40 . . . . . 49	3-526-22 . . . . . 123	3-541-24 . . . . . 71	3-560-24 . . . . . 107
3-515-14 . . . . . 61	3-526-24 . . . . . 123	3-542-20 . . . . . 143	3-560-40 . . . . . 107
3-515-24 . . . . . 61	3-527-20 . . . . . 103	3-542-24 . . . . . 143	3-563-114 . . . . . 93
3-515-25 . . . . . 61	3-527-22 . . . . . 103	3-543-14 . . . . . 145	3-563-124 . . . . . 93
3-515-40 . . . . . 61	3-527-24 . . . . . 103	3-543-24 . . . . . 145	3-563-214 . . . . . 93
3-516-24 . . . . . 75	3-528-24 . . . . . 67	3-544-24 . . . . . 135	3-563-224 . . . . . 93
3-516-40 . . . . . 75	3-528-40 . . . . . 67	3-545-20 . . . . . 65	3-564-122 . . . . . 57
3-517-14 . . . . . 89	3-528-124 . . . . . 67	3-545-24 . . . . . 65	3-564-124 . . . . . 57
3-517-24 . . . . . 89	3-528-140 . . . . . 67	3-547-20 . . . . . 129	3-564-140 . . . . . 57
3-518-24 . . . . . 69	3-530-22 . . . . . 111	3-547-20-BP220 . . . 129	3-564-222 . . . . . 57
3-518-25 . . . . . 69	3-530-24 . . . . . 111	3-547-24 . . . . . 129	3-564-224 . . . . . 57
3-518-40 . . . . . 69	3-530-40 . . . . . 111	3-547-24-BP224 . . . 129	3-564-240 . . . . . 57
3-518-124 . . . . . 69	3-532-22 . . . . . 37	3-549-20 . . . . . 129	3-567-115 . . . . . 55
3-518-125 . . . . . 69	3-532-24 . . . . . 37	3-549-20-BP420 . . . 129	3-567-120 . . . . . 55
3-518-140 . . . . . 69	3-532-40 . . . . . 37	3-549-24 . . . . . 129	3-567-124 . . . . . 55
3-519-20 . . . . . 101	3-533-22 . . . . . 119	3-549-24-BP424 . . . 129	3-567-215 . . . . . 55
3-519-24 . . . . . 101	3-533-24 . . . . . 119	3-551-15 . . . . . 41	3-567-220 . . . . . 55
3-520-14 . . . . . 73	3-534-20 . . . . . 149	3-551-20 . . . . . 41	3-567-224 . . . . . 55
3-520-24 . . . . . 73	3-534-24 . . . . . 149	3-551-24 . . . . . 41	3-569-20 . . . . . 155
3-520-40 . . . . . 73	3-535-14 . . . . . 61	3-552-20 . . . . . 127	3-569-24 . . . . . 155
3-521-14 . . . . . 47	3-535-24 . . . . . 61	3-552-24 . . . . . 127	3-570-24 . . . . . 39
3-521-22 . . . . . 47	3-535-25 . . . . . 61	3-553-15 . . . . . 45	3-571-20 . . . . . 115



# INDEX

item #. . . . . pg #	item #. . . . . pg #	item #. . . . . pg #	item #. . . . . pg #
3-571-24 . . . . . 115	3-619-14-EM . . . . . 181	3-651-2018 . . . . . 199	3-670-22 . . . . . 217
3-575-20 . . . . . 125	3-619-22 . . . . . 179	3-652-14 . . . . . 213	3-670-24 . . . . . 217
3-575-24 . . . . . 125	3-619-22-EM . . . . . 181	3-652-1314 . . . . . 213	3-670-40 . . . . . 217
3-582-24 . . . . . 131	3-619-24 . . . . . 179	3-652-2018 . . . . . 213	3-671-20 . . . . . 217
3-587-124 . . . . . 43	3-619-24-EM . . . . . 181	3-653-14 . . . . . 221	3-671-22 . . . . . 217
3-587-195 . . . . . 43	3-619-40 . . . . . 179	3-653-24 . . . . . 221	3-671-24 . . . . . 217
3-587-224 . . . . . 43	3-619-40-EM . . . . . 181	3-653-40 . . . . . 221	3-671-40 . . . . . 217
3-587-295 . . . . . 43	3-620-14 . . . . . 179	3-653-114 . . . . . 221	3-672-20 . . . . . 217
3-588-24 . . . . . 141	3-620-14-EM . . . . . 181	3-653-124 . . . . . 221	3-672-22 . . . . . 217
3-588-40 . . . . . 141	3-620-22 . . . . . 179	3-653-140 . . . . . 221	3-672-24 . . . . . 217
3-588-124 . . . . . 141	3-620-22-EM . . . . . 181	3-654-14 . . . . . 223	3-672-40 . . . . . 217
3-588-140 . . . . . 141	3-620-24 . . . . . 179	3-654-24 . . . . . 223	3-673-20 . . . . . 217
3-589-124 . . . . . 95	3-620-24-EM . . . . . 181	3-654-25 . . . . . 223	3-673-22 . . . . . 217
3-590-24 . . . . . 139	3-620-40 . . . . . 179	3-654-40 . . . . . 223	3-673-24 . . . . . 217
3-590-40 . . . . . 139	3-620-40-EM . . . . . 181	3-654-114 . . . . . 223	3-673-40 . . . . . 217
3-590-124 . . . . . 139	3-622-24 . . . . . 173	3-654-124 . . . . . 223	3-677-115 . . . . . 203
3-590-140 . . . . . 139	3-623-14 . . . . . 173	3-654-125 . . . . . 223	3-677-120 . . . . . 203
3-593-14 . . . . . 137	3-623-14-EM . . . . . 175	3-654-140 . . . . . 223	3-677-124 . . . . . 203
3-593-24 . . . . . 137	3-623-24 . . . . . 173	3-656-14 . . . . . 227	3-677-215 . . . . . 203
3-600-22 . . . . . 183	3-623-24-EM . . . . . 175	3-656-1314 . . . . . 227	3-677-220 . . . . . 203
3-600-24 . . . . . 183	3-624-14 . . . . . 173	3-656-2018 . . . . . 227	3-677-224 . . . . . 203
3-600-40 . . . . . 183	3-624-24 . . . . . 173	3-662-15 . . . . . 163	3-678-115 . . . . . 203
3-607-24 . . . . . 219	3-625-24 . . . . . 173	3-662-20 . . . . . 163	3-678-120 . . . . . 203
3-607-40 . . . . . 219	3-625-24-EM . . . . . 175	3-662-24 . . . . . 163	3-678-124 . . . . . 203
3-607-124 . . . . . 219	3-626-14 . . . . . 173	3-667-115 . . . . . 203	3-678-215 . . . . . 203
3-607-140 . . . . . 219	3-626-24 . . . . . 173	3-667-120 . . . . . 203	3-678-220 . . . . . 203
3-609-14 . . . . . 207	3-634-1314 . . . . . 205	3-667-124 . . . . . 203	3-678-224 . . . . . 203
3-609-124 . . . . . 207	3-634-2018 . . . . . 205	3-667-215 . . . . . 203	3-683-24 . . . . . 177
3-609-1414 . . . . . 207	3-635-14 . . . . . 209	3-667-220 . . . . . 203	3-683-24-EM . . . . . 177
3-610-22 . . . . . 191	3-635-18 . . . . . 209	3-667-224 . . . . . 203	3-683-40 . . . . . 177
3-610-24 . . . . . 191	3-635-24 . . . . . 209	3-668-115 . . . . . 203	3-683-40-EM . . . . . 177
3-610-40 . . . . . 191	3-639-24 . . . . . 201	3-668-120 . . . . . 203	3-689-24 . . . . . 171
3-618-14 . . . . . 179	3-640-24 . . . . . 201	3-668-124 . . . . . 203	3-689-24-EM . . . . . 171
3-618-22 . . . . . 179	3-648-6 . . . . . 193	3-668-215 . . . . . 203	3-689-40 . . . . . 171
3-618-24 . . . . . 179	3-649-6 . . . . . 193	3-668-220 . . . . . 203	3-689-40-EM . . . . . 171
3-618-40 . . . . . 179	3-651-14 . . . . . 199	3-668-224 . . . . . 203	3-694-24 . . . . . 167
3-619-14 . . . . . 179	3-651-1314 . . . . . 199	3-670-20 . . . . . 217	3-694-24-EM . . . . . 167

item #. . . . . pg #	item #. . . . . pg #	item #. . . . . pg #	item #. . . . . pg #
3-695-24 . . . . . 167	3-728-16 . . . . . 249	3-5011-15. . . . . 133	32-631-40 . . . . . 195
3-695-24-EM. . . . . 167	3-728-22 . . . . . 249	3-5011-20 . . . . . 133	32-632-15 . . . . . 231
3-700-16 . . . . . 261	3-730-16 . . . . . 235	3-5011-24 . . . . . 133	32-632-20 . . . . . 231
3-700-22 . . . . . 261	3-730-22 . . . . . 235	3-5012-15 . . . . . 133	32-632-24 . . . . . 231
3-701-16 . . . . . 261	3-731-16 . . . . . 235	3-5012-20 . . . . . 133	32-633-15 . . . . . 231
3-701-22 . . . . . 261	3-731-22 . . . . . 235	3-5012-24 . . . . . 133	32-633-20 . . . . . 231
3-702-16 . . . . . 239	3-736-16 . . . . . 241	3-5013-15 . . . . . 133	32-633-24 . . . . . 231
3-702-22 . . . . . 239	3-736-22 . . . . . 241	3-5013-20 . . . . . 133	32-642-15 . . . . . 211
3-703-16 . . . . . 239	3-737-16 . . . . . 241	3-5013-24 . . . . . 133	32-642-20 . . . . . 211
3-703-22 . . . . . 239	3-737-22 . . . . . 241	3-5020-15 . . . . . 105	32-642-24 . . . . . 211
3-710-222 . . . . . 259	3-739-16 . . . . . 245	3-5020-24 . . . . . 105	32-664-24 . . . . . 165
3-710-222-EM . . . . . 259	3-739-22 . . . . . 245	3-5020-40 . . . . . 105	32-665-24 . . . . . 165
3-710-224 . . . . . 259	3-740-16 . . . . . 251	3-5021-15 . . . . . 157	32-665-24-EM . . . . . 165
3-710-224-EM . . . . . 259	3-740-22 . . . . . 251	3-5021-24 . . . . . 157	
3-711-222 . . . . . 259	3-742-16 . . . . . 251	3-5022-15 . . . . . 157	
3-711-222-EM . . . . . 259	3-742-22 . . . . . 251	3-5022-24 . . . . . 157	
3-711-224 . . . . . 259	3-750-16 . . . . . 253	3-5023-15 . . . . . 157	
3-711-224-EM . . . . . 259	3-750-22 . . . . . 253	3-5023-24 . . . . . 157	
3-712-222 . . . . . 247	3-752-16 . . . . . 257	3-6202-22 . . . . . 225	
3-712-222-EM . . . . . 247	3-752-22 . . . . . 257	3-6202-24 . . . . . 225	
3-712-224 . . . . . 247	3-5000-15 . . . . . 97	3-6202-25 . . . . . 225	
3-712-224-EM . . . . . 247	3-5000-20 . . . . . 97	3-6203-22 . . . . . 229	
3-713-222 . . . . . 247	3-5000-24 . . . . . 97	3-6203-24 . . . . . 229	
3-713-222-EM . . . . . 247	3-5000-40 . . . . . 97	32-601-20 . . . . . 185	
3-713-224 . . . . . 247	3-5001-15 . . . . . 153	32-601-20-EM . . . . . 185	
3-713-224-EM . . . . . 247	3-5001-20 . . . . . 153	32-601-24 . . . . . 185	
3-719-15 . . . . . 255	3-5001-24 . . . . . 153	32-601-24-EM . . . . . 185	
3-719-16 . . . . . 255	3-5002-15 . . . . . 153	32-601-40 . . . . . 185	
3-720-16 . . . . . 243	3-5002-20 . . . . . 153	32-601-40-EM . . . . . 185	
3-720-22 . . . . . 243	3-5002-24 . . . . . 153	32-612-20 . . . . . 191	
3-721-16 . . . . . 243	3-5003-15 . . . . . 153	32-612-24 . . . . . 191	
3-721-22 . . . . . 243	3-5003-20 . . . . . 153	32-612-40 . . . . . 191	
3-726-16 . . . . . 237	3-5003-24 . . . . . 153	32-630-15 . . . . . 195	
3-726-22 . . . . . 237	3-5010-15 . . . . . , 4	32-630-24 . . . . . 195	
3-727-16 . . . . . 237	3-5010-20 . . . . . , 4	32-630-40 . . . . . 195	
3-727-22 . . . . . 237	3-5010-24 . . . . . , 4	32-631-15 . . . . . 195	
3-728-15 . . . . . 249	3-5010-40 . . . . . , 4	32-631-24 . . . . . 195	

# 2019-2020 ORDERING INFORMATION

phone: 877.607.0202

fax: 877.607.0203

email: [customersupport@oxygenlighting.com](mailto:customersupport@oxygenlighting.com)

## HOW TO ORDER

Orders are placed with authorized Oxygen sales representatives.

## WAREHOUSE/ORDERING HOURS

Warehouse operations are open from 8:00am - 5:30pm Central Standard Time Monday through Friday.

## PRICES

Buyer agrees to pay Company's established prices in effect on date of shipment if shipment is from other persons or firms, or on date of delivery if delivered from Company's stock. Prices are F.O.B. shipping point. Where transportation charges are expressly included, the same are based on present rates, and are subject to adjustment for any increase or decrease in effect at time of shipment. Any direct tax, including sales or use tax, imposed by law with respect to the sale or manufacture of any merchandise sold is to be added.

## TERMS

All invoices are due and payable on a net 30-day basis from invoice date unless otherwise stated on the invoice. All past due invoices arising hereunder or otherwise owing to Company by Buyer shall bear interest at the maximum rate per annum provided by law, but in no event any rate in excess of that permitted by law.

## CREDIT

All sales are subject to approval by the credit department of Company. If the credit rating of Buyer becomes unsatisfactory in the opinion of the credit department of Company prior to delivery of the merchandise covered by any order, the sale may be cancelled by Company. If Buyer fails to fulfill any terms of the purchase agreed upon in connection with this or any other order, Company may defer delivery until compliance therewith is made, or at its option may cancel any sale. For credit approval of new accounts, a completed and signed Company credit application must be in our possession before credit verification can begin. New accounts normally take 48 hours to process. Company uses the services of Dun & Bradstreet and other credit reporting companies for credit analysis. We report delinquent accounts to those companies. We fill orders only after credit approval. Active accounts will be credit determined the same day the order is received. Orders for past due accounts are not shipped until the account status is current.

## DELIVERY

Company shall not be responsible for any delay or failure to make delivery which is occasioned by causes beyond its control, including but not restricted to fires, floods, strikes, labor disputes, accidents, embargoes, delays in transportation, fuel, material or labor shortages, failure to obtain delivery from manufacturers or subcontractors, any ruling, regulation or law of any government bureau or agency, or by any Act of God. Delays so caused shall not release Buyer from his obligation to accept and pay for goods. Company's responsibility ceases upon delivery of the merchandise to the carrier.

## SHIPPING POINT FOR ALL PURPOSES

All shipments are FOB Company's warehouse, in Fort Worth, Tarrant County, Texas.

## FREIGHT PROGRAM

Company ships via the least expensive, not necessarily the fastest, carriers. If Buyer has a preferred carrier and wishes to pay the freight charges directly to the carrier, please provide your account number for the carrier of your choice. For basic ground transportation services, the Buyer may be asked to pay a premium for custom selected carriers. Buyer will be required to pay the entire Freight Services charge for any shipments using expedited ground transport or air transport services. All orders are shipped Prepaid and Add, unless the Customer requests to be billed Third Party. For orders of \$500 or more: Freight charges for standard LTL commercial delivery or parcel delivery will be equal to 10% of the total order amount for shipments in the USA. If the invoice is paid within its dating Terms, the customer may deduct the Freight charges. For orders less than \$500: Freight charges for Standard LTL commercial delivery or parcel delivery will be equal to 10% of the total order amount for shipments in the USA. Any shipment outside the USA, Buyer should contact Company's Customer Service Department for a freight quote. If any items are backordered, they will also be billed at the same freight rate as the original order, when they ship. Company contracts with LTL Freight carriers for standard commercial delivery only. Residential deliveries or accessorial services from LTL Carriers will incur additional charges that are in addition to the freight rates stated above. If you advise us that you need such services when you place your order, we will prepay for the services and add them to your invoice. Otherwise, the freight carrier will bill you directly for such additional services. Parcel shipments (such as UPS) will not incur additional charges for residential delivery or accessorial services.

## SHORTAGE CLAIMS

Any claim for shortage must be made to Company within 3 days of delivery.

## FREIGHT CLAIMS

We assure that products are in good condition prior to packing and shipping. Company is not responsible for shipments after they leave our warehouse. The carrier signs for acceptance at that time. Buyers must examine all arriving shipments for evidence of damage or breakage, and must refuse acceptance or file a claim with the carrier for compensation. UNDER NO

CIRCUMSTANCES SHALL OXYGEN BE RESPONSIBLE FOR DAMAGE IN U.P.S./FED EX SHIPMENTS. All shipments are FOB Company's warehouse in Fort Worth, Tarrant County, Texas.

## RETURNED GOODS

Merchandise Returned for Credit must be accompanied by a returned merchandise authorization (RMA) number issued by Company within 90 days of our invoice date. Merchandise must be returned, freight prepaid, in its original factory sealed packaging and is subject to a 50% restocking fee. Discontinued, non-standard, modified (CDX) or unsaleable merchandise will not be accepted as returned goods for credit. Merchandise Returned Under Warranty for Credit must be accompanied by a return merchandise authorization (RMA) number issued by us within the warranty period. In addition, ceiling fan warranty claims made by Company dealers on behalf of end users must be accompanied by a copy of the end user's dated proof of purchase as evidence of warranty validity. Merchandise must be returned, freight prepaid, in its original factory packaging. Merchandise that has been modified, or is missing parts, or that is not in its original packaging will be repaired and returned freight prepaid (if the warranty claim is approved). If merchandise cannot be repaired, credit will be issued at the invoiced value, less the value of any missing parts.

## CANCELLATION BY BUYER

No merchandise may be returned for credit or replacement except on written approval by Company. Orders placed with and accepted by Company may not be cancelled except with Company's written consent. Purchase orders cancelled more than 5 days after the date of Acknowledgement / Proforma are subject to a 50% cancellation fee.

## DROP SHIPMENTS

Company reserves the right to refuse drop shipment or pick-up orders that are bound for destinations outside the Buyer's regular or assigned selling or service area. Drop shipments are subject to additional charges and at Company's discretion.

## LIMITED WARRANTY

Company warrants that our products are free of defects in workmanship and materials. **Such warranty is in lieu of all other warranties including, without limitation, any implied warranties of merchantability or fitness for a particular purpose.** Company will, at our sole option, repair or replace, FOB shipping point, freight prepaid within the Continental U.S., any of our products defective in workmanship or materials. Such repair or replacement is the sole and exclusive remedy against Company and is limited to one (1) year from the date of invoice to the original end user of all lighting, ceiling fan and accessory products (except Energy Star lighting products). Company warrants our Energy Star lighting products for three (3) years from the date of the invoice to the original end user. The Company warrants our integral LED light fixtures for five (5) years from the date of invoice to the original end user on driver and array parts. The Company also offers specific warranty on its ceiling fans directly to the end users of such products and such warranties will vary between models. Consult the warranty inside each ceiling fan box for further information. The Company's warranties are not applicable to any lighting product that is not installed and operated in accordance with the National Electric Code (NEC) and Company's product instructions, including, but not limited to, lamping requirements and installation instructions. Consult the warranty included inside each light fixture box for further information. Company does not warrant any product which we promote and sell as "discontinued" or any product which has been altered or repaired outside of our factory or any product which, in our opinion, has been subject to abuse, misuse, negligence, accident or improper installation, maintenance or storage. **Company will not be responsible for any costs incurred in the removal or reinstallation of any product nor any consequential or incidental damages arising out of or in connection with product use or performance or any breach of aforementioned warranties.** The terms, specifications, and conditions contained herein supersede all previous terms, specifications, and conditions, and are subject to change without notice.

## PLACE OF PAYMENT AND APPLICABLE LAW

Buyer agrees to pay all sums which may become due under this order or which he may otherwise owe to Company at the principal office of Company in Fort Worth, Tarrant County, Texas. This agreement shall be governed by and construed in accordance with the laws of the State of Texas. Buyer hereby agrees and consents to the jurisdiction of the Courts of the State of Texas and further consents to the exclusive and mandatory venue in Tarrant County, Texas, for any dispute arising between the Company and Buyer.

## FORBEARANCE/NO WAIVER

Forbearance or failure of Company to enforce any of these conditions or to exercise any right accruing from any default of Buyer shall not affect or impair Company's rights should such default continue or in case of any subsequent default of Buyer, nor shall such forbearance or failure be deemed a waiver of Company's rights in case of other or future defaults of Buyer.

## SECURITY INTEREST

Buyer grants Company a security interest in all goods purchased from Company, the exact description of which goods is found in each invoice presented to Buyer. Buyer appoints Company, as Buyer's attorney-in-fact for purposes of signing and filing with appropriate authority a Financing Statement (UCC-1) or any modification or extension thereof.

CATBIGX19

Oxygen Rev. 1-1-19



# OXXYGEN

2019/20 LIGHTING & FANS