



**BESALIGHTING**

2017 SUPPLEMENT



# BUILD YOUR OWN MULTI LIGHT PENDANT

## 3-LIGHT ROUND, FIXED CONNECT - T23X (12V) OR T33X (120V)

For Pendants using 10" diameter shades MAX, with staggered heights.



## 3-LIGHT LARGE ROUND, FIXED CONNECT - T23XL (12V) OR T33XL (120V)

For Pendants using 16" diameter shades MAX, with staggered heights.



## 6-LIGHT ROUND, FIXED CONNECT - T26X (12V) OR T36X (120V)

For Pendants using 10" diameter shades MAX, with staggered heights.



## 9-LIGHT ROUND, FIXED CONNECT - T29X (12V) OR T39X (120V)

For Pendants using 10" diameter shades MAX, with staggered heights.



## 3-LIGHT BAR, FIXED CONNECT - T23V (12V) OR T33V (120V)

For Pendants using 20" diameter shades MAX, with staggered heights.



## 4-LIGHT BAR, FIXED CONNECT - T24V (12V) OR T34V (120V)

For Pendants using 20" diameter shades MAX, with staggered heights.

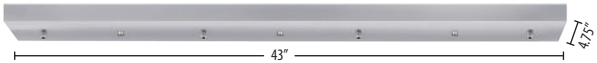

## 7-LIGHT BAR, FIXED CONNECT - T27V (12V) OR T37V (120V)

For Pendants using 14" diameter shades MAX, with staggered heights.

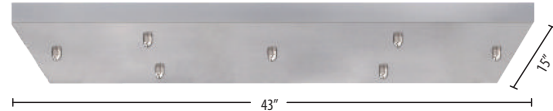

### BUILD YOUR OWN 12V MULTI LIGHT PENDANT



Ordering code for the example shown to the left:

1x T23X-SN  
1x X-JADEAC-SN  
1x X-JADEEG-SN  
1x X-JADEPB-SN

\*For LED pendants, LED Canopy must be ordered.

### 12V MULTIPOINT CANOPY ORDERING

ITEM	- LAMPING	- FINISH	- OPTIONS
T23X	3-light round (blank) Halogen	BR Bronze	277 277V
T23XL	3-light large round LED	SN Satin Nickel	
T26X	6-light round		
T29X	9-light round		
T23V	3-light bar		
T24V	4-light bar		
T27V	7-light bar		

These fixed-connect canopies install easily on std. ceiling junction boxes. Integral low voltage (12V) 60W Class 2 electronic transformers. 120V or 277V input versions.

### BUILD YOUR OWN 120V MULTI LIGHT PENDANT

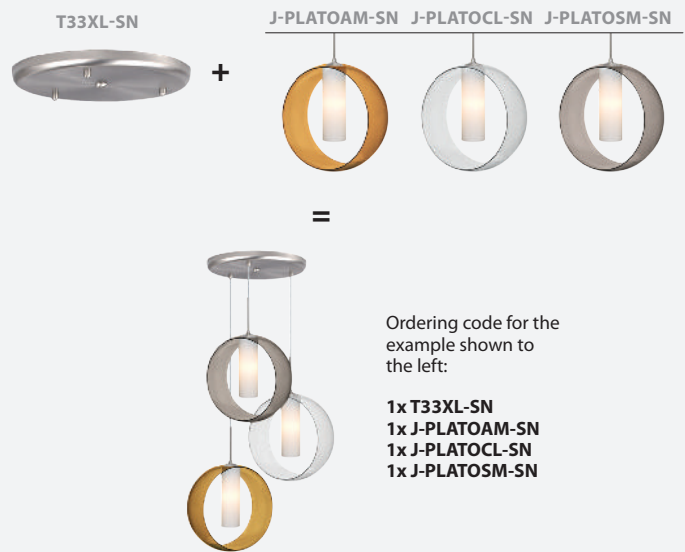

Ordering code for the example shown to the left:

1x T33XL-SN  
1x J-PLATOAM-SN  
1x J-PLATOCL-SN  
1x J-PLATOSM-SN

### 120V MULTIPOINT CANOPY ORDERING

ITEM	- FINISH
T33X	3-light round BR Bronze
T33XL	3-light large round SN Satin Nickel
T36X	6-light round
T39X	9-light round
T33V	3-light bar
T34V	4-light bar
T37V	7-light bar

# PLATO

120V PENDANTS



PLATOBL  
TRANS. BLUE/OPAL



PLATOAM  
TRANS AMBER/OPAL



\*Shown with No Inner Glass (NI) and Plumen lamp (PLU)

PLATOCL  
CLEAR/OPAL

PLATOSM  
TRANS. SMOKE/OPAL



The Plato is a playful double-glass pendant, with a cylindrical-shaped opal glass centered in a radiused outer transparent glass ring.



**STD. LAMP:** 60W B10 120V, lamp not included.

**LED:** 5W Replaceable source, 120V, dimmable, 80+ CRI, 300 lumens, 30,000 hours. Lamp included.

**EDI:** 40W Edison S-style lamp, lamp included. (For No Inner (NI) only)

**PLU:** 9W Plumen lamp, lamp included. (For No Inner (NI) only)

**LOW WATTAGE LABELING:** Incandescent fixture supplied with 16 watt relamp label

**LOCATION: DAMP**

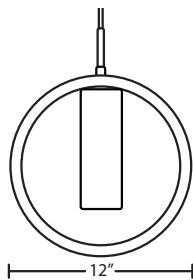

CONNECTION	SHADE OPTIONS	LAMP OPTIONS	METAL FINISH	OPTIONS
Pendant Fixtures	<b>PLATOAM</b> Trans. Amber/Opal	<b>(blank)</b> 60W Incan	<b>BR</b> Bronze	<b>L</b> 15' cord
<b>1JC</b> Dome Canopy	<b>PLATOBL</b> Trans. Blue/Opal	<b>LED</b> 5W LED 120V, dimmable	<b>SN</b> Satin Nickel	<b>LW</b> Low wattage labeling
<b>1JT</b> Flat Canopy	<b>PLATOCL</b> Clear/Opal	<b>EDI</b> 40W Edison (For NI option)		<b>NI</b> No Inner Glass
Stem Fixtures	<b>PLATOSM</b> Trans. Smoke/Opal	<b>PLU</b> 9W Plumen (For NI option)		
<b>1TT</b> Flat Canopy				

Multi light  
J For Multi light Canopy



For more information refer to inside cover

**Ex. 1JT-PLATOCL-SN**  
Plato Glass Pendant, Clear/Opal, Satin Nickel Finish



# PHANTOM 6

120V PENDANTS



PHAN6CL  
CLEAR



PHAN6SC  
SMOKE/CLEAR



PHAN6WC  
WHITE/CLEAR

The Phantom 6 Pendant is composed of a bell-shaped glass shade, with an interesting cascading optical pattern blown as an additional transparent layer along the top upper portion of the glass.

**STD. LAMP:** 60W T10 120V, lamp not included.

**EDIL:** 5W Replaceable LED Filament lamp, 120V, dimmable, 80+ CRI, 450 lumens, 15,000 hours, lamp included.

**LOW WATTAGE LABELING:** Incandescent fixture supplied with 16 watt relamp label

**LOCATION:** DAMP

**CONNECTION**

- Pendant Fixtures
- 1JC Dome Canopy
- 1JT Flat Canopy

**SHADE OPTIONS**

- 1TT Flat Canopy

**LAMP OPTIONS**

- Multi light
- J For Multi light Canopy



For more information refer to inside cover

**SHADE OPTIONS**

- PHAN6CL Clear
- PHAN6SC Smoke/Clear
- PHAN6WC White/Clear

**LAMP OPTIONS**

- (blank) 60W T10
- EDIL 5W LED Filament

**METAL FINISH**

- BR Bronze
- SN Satin Nickel

**OPTIONS**

- L 15' cord
- LW Low wattage labeling

**Ex. 1JT-PHAN6SC-SN**

Phantom 6 Pendant, Smoke/Clear Shade, Satin Nickel Finish

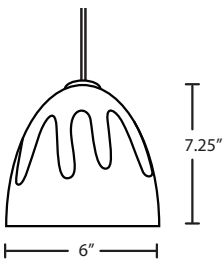



# ROCKY

120V PENDANTS



ROCKYBK  
BLACK



ROCKYWH  
WHITE



ROCKYCP  
COPPER

\*Shown with LED lamp (LED)

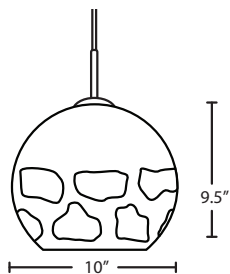

The Rocky Pendant features a unique globe shade that enhances the beauty of shimmering glass with the visual interesting cutouts, resulting in a compelling optical display in a smartly modern design.



**STD LAMP:** 60W A19 120V, lamp not included.

**LED:** 9W Replaceable source, 120V, dimmable, 80+ CRI, 3000°K CCT, 800 lumens, 30,000 hours. Lamp included.

**LOW WATTAGE LABELING:** Incandescent fixture supplied with 16 watt relamp label

**LOCATION: DAMP**

CONNECTION	SHADE OPTIONS	LAMP OPTIONS	METAL FINISH	OPTIONS
Pendant Fixtures	ROCKYBK Black	(blank) 60W Incan	BR Bronze	L 15' cord
1JC Dome Canopy	ROCKYCP Copper	LED 9W LED 120V, dimmable	SN Satin Nickel	LW Low wattage labeling
1JT Flat Canopy	ROCKYWH White			

Stem Fixtures  
1TT Flat Canopy

Multi light  
J For Multi light Canopy



For more information refer to inside cover

**Ex. 1JT-ROCKYCP-SN**  
Rocky Glass Pendant, Copper, Satin Nickel Finish





# OMEGA 12

## 120V PENDANTS



OMEGA12WH  
WHITE/CLEAR

*\*Shown with LED Filament lamp (EDIL)*



OMEGA12CL  
CLEAR

*\*Shown with LED Filament lamp (EDIL)*



OMEGA12AM  
AMBER/CLEAR

*\*Shown with LED Filament lamp (EDIL) and in Bronze finish (BR)*

OMEGA12RD  
RED/CLEAR



OMEGA12ST  
STEEL/CLEAR

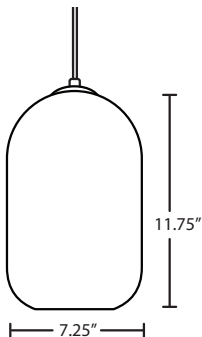

*The Omega 12 Pendant is a transitional design composed of a transparent blown glass cylinder pendant, with an artistic gradient pattern from top to bottom of the glass.*



**STD. LAMP:** 60W T10 120V, lamp not included.

**EDIL:** 4W Replaceable LED Filament lamp, 120V, dimmable, 80+ CRI, 320 lumens, 15,000 hours, lamp included.

**LOW WATTAGE LABELING:** Incandescent fixture supplied with 16 watt relamp label

**LOCATION: DAMP**

CONNECTION	SHADE OPTIONS	LAMP OPTIONS	METAL FINISH	OPTIONS
Pendant Fixtures	<b>OMEGA12AM</b> Amber/Clear	<b>(blank)</b> 60W T10	<b>BR</b> Bronze	<b>L</b> 15' cord
<b>1JC</b> Dome Canopy	<b>OMEGA12CL</b> Clear	<b>EDIL</b> 4W LED	<b>SN</b> Satin Nickel	<b>LW</b> Low wattage labeling
<b>1JT</b> Flat Canopy	<b>OMEGA12RD</b> Red/Clear	Filament		
Stem Fixtures	<b>OMEGA12ST</b> Steel/Clear			
<b>1TT</b> Flat Canopy	<b>OMEGA12WH</b> White/Clear			

Multi light  
**J** For Multi light Canopy



For more information refer to inside cover

**Ex. 1XT-OMEGA12ST-LED-SN**  
Omega 12 LED Pendant, Steel Shade, Satin Nickel Finish





# LITHIUM 8 / 12

## 120V PENDANTS

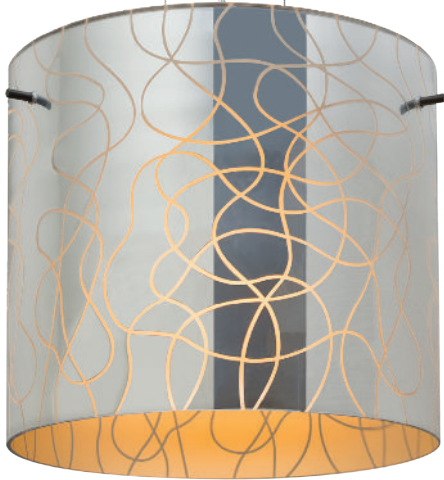

LITH120R  
LITHIUM ORANGE



LITH8RD  
LITHIUM RED

\*Shown as Stem Fixture (1TT)



LITH8PL  
LITHIUM PURPLE

LITHIUM CREME

LITHIUM BLUE



Lithium 8: LITH8

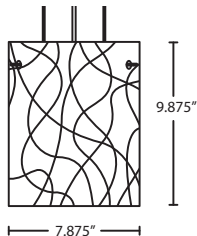

Lithium 12: LITH12

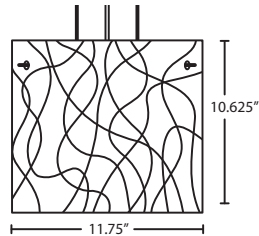

Our Lithium is a distinctive double-glass pendant, with a colored inner cylinder centered within the randomly etched mirror outer glass, designed to suit any modern decor ready for a splash of color.



**STD. LAMP:** 100W A19 120V, lamp not included.

**LED:** 11W Replaceable source, 120V, dimmable, 80+ CRI, 3000°K CCT, 1100 lumens, 30,000 hours. Lamp included.

**LOCATION: DAMP**

CONNECTION	GLASS OPTIONS	LAMP OPTIONS	METAL FINISH
3x Cable Fixtures	LITH8BL 8" Lithium Blue	(blank) 100W Incan	BR Bronze
1KG Flat Canopy	LITH8OR 8" Lithium Orange	LED 11W LED	SN Satin Nickel
Stem Fixture	LITH8RD 8" Lithium Red		
1TT Flat Canopy	LITH8PL 8" Lithium Purple		
	LITH8CR 8" Lithium Creme		

CONNECTION	GLASS OPTIONS	LAMP OPTIONS	METAL FINISH
3x Cable Fixtures	LITH12BL 12" Lithium Blue	(blank) 100W Incan	BR Bronze
1KG Flat Canopy	LITH12OR 12" Lithium Orange	LED 11W LED	SN Satin Nickel
Stem Fixture	LITH12RD 12" Lithium Red		
1TT Flat Canopy	LITH12PL 12" Lithium Purple		
	LITH12CR 12" Lithium Creme		

**Ex. 1KG-LITHIUM12BL-LED-SN**  
Lithium 12 LED Pendant, Lithium Blue Shade, Satin Nickel Finish



# VENUS

## 120V PENDANTS



VENUS

*\*White Acrylic diffuser can be removed for an optional open bottom appearance.*

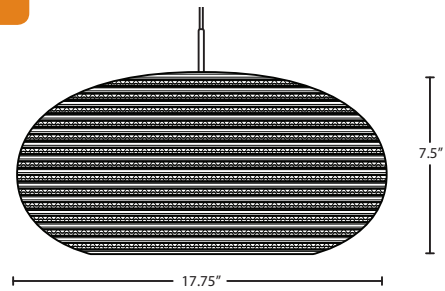

*The urban stylings of our Venus LED pendant are ideal for today's modern architecture, composed of intricately cut layers of tan corrugated cardboard that are fused together in a broadly curved shade.*



**LED:** 9W Replaceable source, 120V, dimmable, 80+ CRI, 3000°K CCT, 800 lumens, 30,000 hours. Lamp included.

**LOW WATTAGE LABELING:** Incandescent fixture supplied with 16 watt relamp label

**LOCATION:** DRY

CONNECTION	SHADE OPTIONS	LAMP OPTIONS	METAL FINISH	OPTIONS
Pendant Fixtures	<b>VENUS</b> Venus	<b>LED</b> 9W LED 120V, dimmable	<b>BR</b> Bronze <b>SN</b> Satin Nickel	<b>L</b> 15' cord <b>LW</b> Low wattage labeling
Stem Fixtures	Corrugated Cardboard			
<b>1JC</b> Dome Canopy				
<b>1JT</b> Flat Canopy				
<b>1TT</b> Flat Canopy				

**\*Consult factory for multi light options**

**Ex. 1JT-VENUS-LED-SN**  
Venus Pendant,  
Satin Nickel Finish



# KIRK 6

## 120V PENDANTS

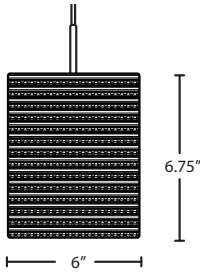

Our geometrically inspired Kirk 6 LED pendant is ideal for urban spaces, composed of intricately cut layers of tan corrugated cardboard, that are fused together in a diminutive cube shade. Can be paired with our Kirk 12 in a multi light configuration to create an interesting eclectic display.



**LED:** 9W Replaceable source, 120V, dimmable, 80+ CRI, 3000°K CCT, 800 lumens, 30,000 hours. Lamp included.

**LOW WATTAGE LABELING:** Incandescent fixture supplied with 16 watt relamp label

**LOCATION: DRY**



KIRK 6

CONNECTION	SHADE OPTIONS	LAMP OPTIONS	METAL FINISH	OPTIONS
Pendant Fixtures	<b>KIRK6</b> Kirk 6	<b>LED</b> 9W LED 120V, dimmable	<b>BR</b> Bronze <b>SN</b> Satin Nickel	<b>L</b> 15' cord <b>LW</b> Low wattage labeling
<b>1JC</b> Dome Canopy	Corrugated			
<b>1JT</b> Flat Canopy	Cardboard			
<b>1TT</b> Flat Canopy				

Multi light  
**J** For Multi light Canopy

For more information refer to inside cover

**Ex. 1JT-KIRK6-LED-SN**  
Kirk 6 Pendant,  
Satin Nickel Finish

# KIRK 12

## 120V PENDANTS

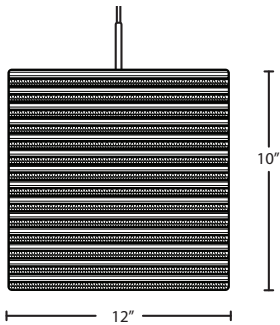

Our geometrically inspired Kirk 12 LED pendant is ideal for urban spaces, composed of intricately cut layers of tan corrugated cardboard, that are fused together in a cube shade.



**LED:** 9W Replaceable source, 120V, dimmable, 80+ CRI, 3000°K CCT, 800 lumens, 30,000 hours. Lamp included.

**LOW WATTAGE LABELING:** Incandescent fixture supplied with 16 watt relamp label

**LOCATION: DRY**



KIRK 12

\*White Acrylic diffuser can be removed for an optional open bottom appearance.

CONNECTION	SHADE OPTIONS	LAMP OPTIONS	METAL FINISH	OPTIONS
Pendant Fixtures	<b>KIRK12</b> Kirk 12	<b>LED</b> 9W LED 120V, dimmable	<b>BR</b> Bronze <b>SN</b> Satin Nickel	<b>L</b> 15' cord <b>LW</b> Low wattage labeling
<b>1JC</b> Dome Canopy	Corrugated			
<b>1JT</b> Flat Canopy	Cardboard			
<b>1TT</b> Flat Canopy				

Multi light  
**J** For Multi light Canopy

For more information refer to inside cover

**Ex. 1JT-KIRK12-LED-SN**  
Kirk 12 Pendant,  
Satin Nickel Finish



*9-light round 12V LED multiport canopy with five Boca 3 12V LED Mini pendants in Clear Bubble and four Boca 5 12V LED Mini Pendants in Clear Bubble.*

*Ordering Code:*

*1x T29X-LED-SN*

*5x X-BOCA3BB-LED-SN*

*4x X-BOCA5BB-LED-SN*



# BOCA 3 / 5

## 12V MINI PENDANTS



BOCA3CL  
CLEAR



BOCA3BB  
CLEAR BUBBLE



BOCA5CL  
CLEAR



BOCA5BB  
CLEAR BUBBLE

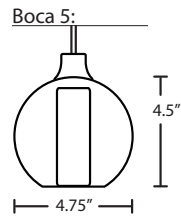
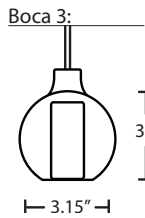

The Boca LED Mini Pendant is comprised of an appealing globe-shaped clear or bubble-patterned solid glass, accented by an inner frosted tube to diffuse the light source. Particularly zen-like when used in multi light configurations, where the sizes and decors can be mixed together.



**LAMP:** 35W Low-pressure Halogen 12V Bi-Pin GY6.35, lamp included.

**LED:** 6W source, dimmable, 85+ CRI, 3000°K CCT, 450 lumens, 30,000 hours, lamp included.

**LOCATION: DRY**

CONNECTION	GLASS OPTIONS	LAMP OPTIONS	METAL FINISH
Quick-Connect	<b>BOCA3BB</b> 3.15" Clear Bubble	(blank) 35W Hal	<b>BR</b> Bronze
<b>XP</b> Jack Only	<b>BOCA3CL</b> 3.15" Clear	<b>LED</b> 6W LED	<b>SN</b> Satin Nickel
<b>RXP</b> Rail-Ready	<b>BOCA5BB</b> 4.75" Clear Bubble	* LED option is for X, 1XC or 1XT fixtures ONLY.	
<b>1XP</b> Flat Canopy	<b>BOCA5CL</b> 4.75" Clear		

Pendant Fixtures

**1XC** Dome Canopy

**1XT** Flat Canopy

Multi light

**X** For Multi light Canopy



For more information refer to inside cover

**Ex. 1XT-BOCA5CL-LED-SN**  
Boca 5 LED Pendant, Clear Shade, Satin Nickel Finish



# EVE

## 120V PENDANTS

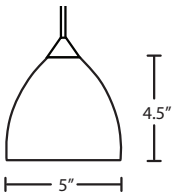

*Eve is a classic bell-shaped shade of handcrafted glass, a shape that stands the test of time. The decor is a clear blown glass with an outer texture of coarse sandstone, with distressed metal foil hand applied on the inner surface.*



**LAMP:** 50W Low-pressure Halogen 12V Bi-Pin GY6.35, lamp included.

**LED:** 6W source, dimmable, 85+ CRI, 3000°K CCT, 450 lumens, 30,000 hours, lamp included.

**LOCATION:** DRY



EVECS  
STONE SILVER FOIL

EVECS  
STONE COPPER FOIL

EVECS  
STONE GOLD FOIL

### CONNECTION

- Quick-Connect
- XP** Jack Only
- RXP** Rail-Ready
- 1XP** Flat Canopy

### GLASS OPTIONS

- EVECS** Stone Copper Foil
- EVEGS** Stone Gold Foil
- EVESS** Stone Silver Foil

### LAMP OPTIONS

- (blank) 50W Hal
- LED** 6W LED

### METAL FINISH

- BR** Bronze
- SN** Satin Nickel

\* LED option is for X, 1XC or 1XT fixtures ONLY.

- Pendant Fixtures
- 1XC** Dome Canopy
- 1XT** Flat Canopy

Multi light

- X** For Multi light Canopy



For more information refer to inside cover

### Ex. 1XT-EVECS-LED-SN

Eve LED Pendant, Stone Copper Foil Shade, Satin Nickel Finish



# JADE

## 12V MINI PENDANTS



JADEEG  
EMERALD/GOLD



JADEAC  
AMBER/CREME  
*\*Shown in Bronze finish (BR)*

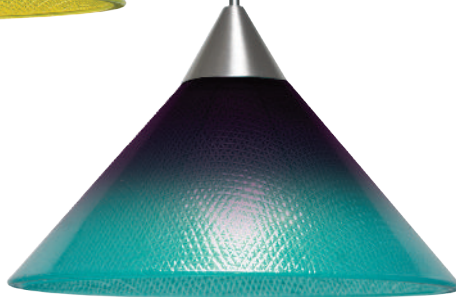

JADEPB  
PURPLE/BLUE

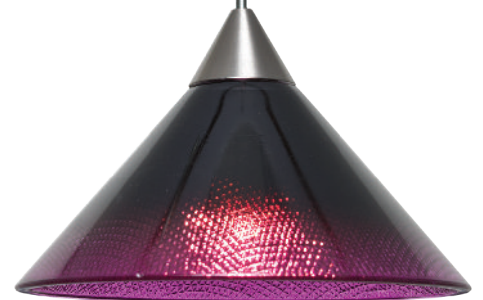

JADEBP  
BLACK/PLUM

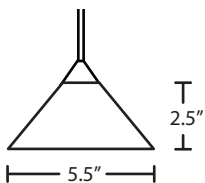

The Jade Mini pendant features a bicolor glass, melding the two complimentary colors to create a refined contemporary look. Our prismatic cone-shaped glass is internally stippled with a glossy outer finish, enhancing the appeal of the vibrant colors.

**LAMP:** 50W Low-pressure Halogen 12V Bi-Pin GY6.35, lamp included.

**LED:** 6W source, dimmable, 85+ CRI, 3000°K CCT, 450 lumens, 30,000 hours, lamp included.

**LOCATION: DRY**

CONNECTION	GLASS OPTIONS	LAMP OPTIONS	METAL FINISH
Quick-Connect	JADEAC Amber/Creme	(blank) 50W Hal	BR Bronze
XP Jack Only	JADEBP Black/Plum	LED 6W LED	SN Satin Nickel
RXP Rail-Ready	JADEEG Emerald/Gold		
1XP Flat Canopy	JADEPB Purple/Blue		

*\* LED option is for X, 1XC or 1XT fixtures ONLY.*

Pendant Fixtures  
1XC Dome Canopy  
1XT Flat Canopy

Multi light  
X For Multi light  
Canopy



For more  
information refer  
to inside cover

**Ex. 1XT-JADEEG-LED-SN**  
Jade LED Pendant, Emerald/Gold Shade,  
Satin Nickel Finish

# VIBE 8

## 12V MINI PENDANTS



VIBE8SM  
SMOKE



VIBE8CL  
CLEAR

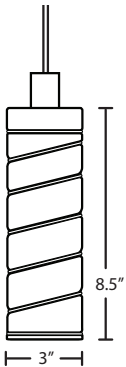

The Vibe 8 LED Mini Pendant is comprised of an appealing clear tubular glass, accented by an interesting dimensioned metal spiral formed into the glass from top to the bottom. The splash of concealed LED downlight onto the encased metal winding makes the Vibe 8 a stunning display of light accents and shadows.



**LED:** 2W Integrated source, dimmable, 85+ CRI, 3000°K CCT, 300 lumens, 30,000 hours, lamp included.

**LOCATION: DRY**

CONNECTION	GLASS OPTIONS	LAMP OPTIONS	METAL FINISH
Quick-Connect	VIBE8CL 8.5" Clear	LED 2W LED	BR Bronze
XP Jack Only	VIBE8SM 8.5" Smoke		SN Satin Nickel
RXP Rail-Ready			
1XP Flat Canopy			

Pendant Fixtures  
**1XC** Dome Canopy  
**1XT** Flat Canopy

Multi light  
**X** For Multi light Canopy



For more information refer to inside cover

**Ex. 1XT-VIBE8CL-LED-SN**  
 Vibe 8 LED Pendant, Clear Glass, Satin Nickel Finish





## TIMO 6

### 12V MINI PENDANTS



TIMO6BC  
CLEAR/BLACK



TIMO6WC  
CLEAR/WHITE



TIMO6BS  
SMOKE/BLACK



TIMO6WS  
SMOKE/WHITE

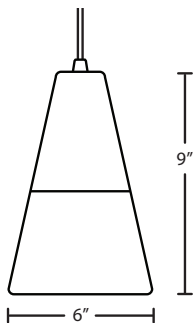

*Our Timo 6 LED Mini Pendant is equipped with a black or white capped conical transparent shade, concealing a focused downlight source for effective task lighting.*



**LED:** 7W Integrated source, dimmable, 85+ CRI, 3000°K CCT, 500 lumens, 30,000 hours, lamp included.

**LOCATION: DRY**

CONNECTION	GLASS OPTIONS	LAMP OPTIONS	METAL FINISH
Quick-Connect	<b>TIMO6BC</b> 6" Clear/Black	<b>LED 7W LED</b>	<b>BR</b> Bronze
<b>XP</b> Jack Only	<b>TIMO6WC</b> 6" Clear/White		<b>SN</b> Satin Nickel
<b>RXP</b> Rail-Ready	<b>TIMO6BS</b> 6" Smoke/Black		
<b>1XP</b> Flat Canopy	<b>TIMO6WS</b> 6" Smoke/White		

Pendant Fixtures  
**1XC** Dome Canopy  
**1XT** Flat Canopy

**Ex. 1XT-TIMO6BC-LED-SN**  
 Timo 6 LED Pendant, Clear/Black Shade, Satin Nickel Finish

Multi light  
**X** For Multi light Canopy  
  
 For more information refer to inside cover

# TOPPER 12

FLUSH MOUNT CEILING



TOPPER12SMC  
OPAL/SMOKE



TOPPER12CLC  
OPAL/CLEAR

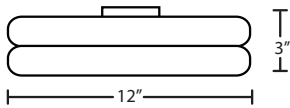

*The low-profile Topper 12 flush mount uses a multi-layered glass, with an upper white ring and lower transparent ring fused together onto a flat white glass.*



**STD LAMPS:** 40W G9 Halogen, lamp included, suitable for dimming.

**LED:** 16W integrated source, 120V, dimmable, 85+ CRI, 3000°K CCT, 30,000 hours.

**LOCATION: DAMP**

FIXTURE/DECOR	LAMP OPTIONS
TOPPER12CLC 12" Dia. Opal/Clear	HAL 2x40W G9 Hal
TOPPER12SMC 12" Dia. Opal/Smoke	LED 16W LED 120V, 1500 lumens

**Ex. TOPPER12CLC-LED**  
Topper 12 Ceiling, Opal/Clear Stone Shade



# PACO 12

FLUSH MOUNT CEILING



PACO12CLC  
OPAL/CLEAR STONE



PACO12SMC  
OPAL/SMOKE STONE

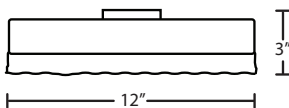

The low-profile Paco 12 flush mount uses a multi-layered glass design, with an upper opal cylinder and lower textured cylinder fused together onto a flat white glass.



**STD LAMPS:** 40W G9 Halogen, lamp included, suitable for dimming

**LED:** 16W integrated source, 120V, dimmable, 85+ CRI, 3000°K CCT, 30,000 hours.

**LOCATION: DAMP**

FIXTURE/DECOR	LAMP OPTIONS
PACO12CLC 12" Dia. Opal/Clear Stone	HAL 2x40W G9 Hal
PACO12SMC 12" Dia. Opal/Smoke Stone	LED 16W LED 120V, 1500 lumens

**Ex. PACO12CLC-LED**  
Paco 12 Ceiling, Opal/Clear Stone Shade

# TUCA 15 / 19

## FLUSH MOUNT CEILING



TUCA19SFC  
OPAL/SILVER FOIL



TUCA15GFC  
OPAL/GOLD FOIL

Tuca 15:

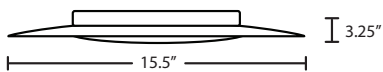

Tuca 19:

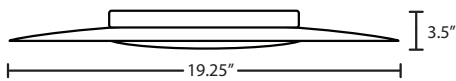

*Tuca LED flush mount marries a clean white handcrafted glass diffuser with a decorative glass ring, consisting of a glossy clear face and distressed metal foil applied to the back.*



**LED:** 16W or 20W integrated source, 120V, dimmable, 85+ CRI, 3000°K CCT, 30,000 hours.

**LOCATION: DAMP**

### FIXTURES

**TUCA15GFC** 15.75" Opal/Gold Foil  
**TUCA15SFC** 15.75" Opal/Silver Foil

### LAMP OPTIONS

**LED** 16W LED 120V  
1600 lumens

### FIXTURES

**TUCA19GFC** 19.25" Opal/Gold Foil  
**TUCA19SFC** 19.25" Opal/Silver Foil

### LAMP OPTIONS

**LED** 20W LED 120V  
2200 lumens

# UNO 16

## FLUSH MOUNT CEILING

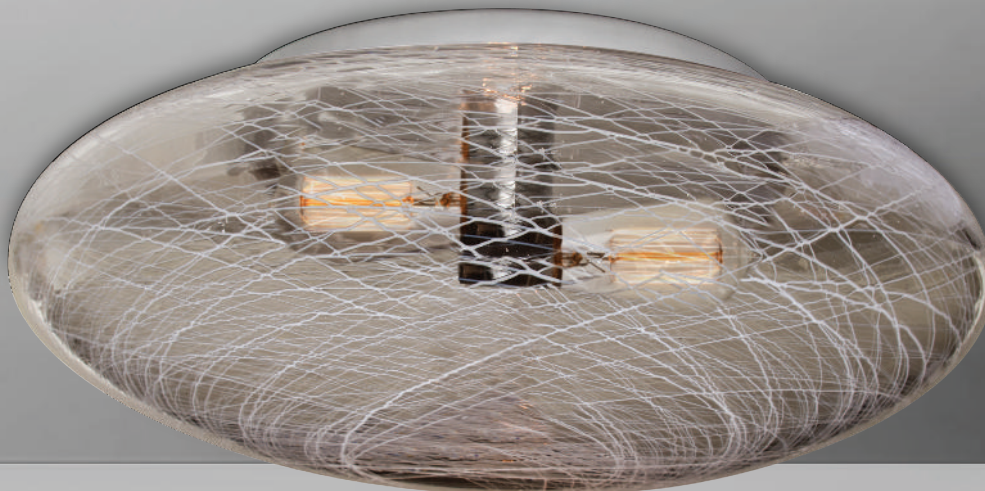

9289SMC  
SMOKE

*\*Shown with Edison lamp  
(EDI)*



9289CLC  
CLEAR

*\*Shown with Edison lamp  
(EDI)*

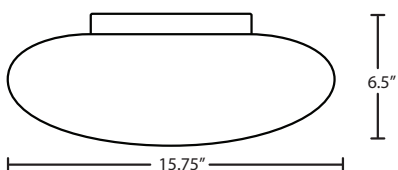

*The Uno 16 semi-flush mount uses a visually appealing weave patterning hand applied onto the clear transparent cloud-shaped glass diffuser.*



**STD. LAMP:** 100W A19 120V, lamp not included.

**EDI:** 40W Edison lamp, lamp included.

**EDIL:** 5W Replaceable LED Filament lamp, 120V, dimmable, 80+ CRI, 450 lumens, 15,000 hours, lamp included.

**LOCATION: DAMP**

FIXTURE/DECOR	LAMP OPTIONS
9289CLC Uno 15.75" Clear	(blank) 2x 100W Incan
9289SMC Uno 15.75" Smoke	EDI 2x 40W Edison
	EDIL 2x 5W LED Filament

**Ex. 9289SMC**  
Uno 16 Ceiling, Smoke Shade



# VENUS

## SEMI-FLUSH MOUNT CEILING



VENUS

*\*White Acrylic diffuser can be removed for an optional open bottom appearance.*

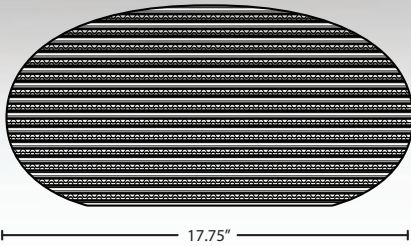

7.5"

*The urban stylings of our Venus LED semi-flush mount are ideal for today's modern architecture, composed of intricately cut layers of tan corrugated cardboard.*



**LED:** 9W Replaceable source, 120V, dimmable, 80+ CRI, 3000°K CCT, 800 lumens, 30,000 hours. Lamp included.

**LOCATION: DRY**

FIXTURE/DECOR	LAMP OPTIONS	METAL FINISH
<b>VENUSC</b> Venus Corrugated Cardboard	<b>LED</b> 9W LED 120V, dimmable	<b>BR</b> Bronze <b>SN</b> Satin Nickel

**Ex. VENUSC-LED-SN**  
Venus Ceiling, Satin Nickel Finish

# KIRK 12

## SEMI-FLUSH MOUNT CEILING

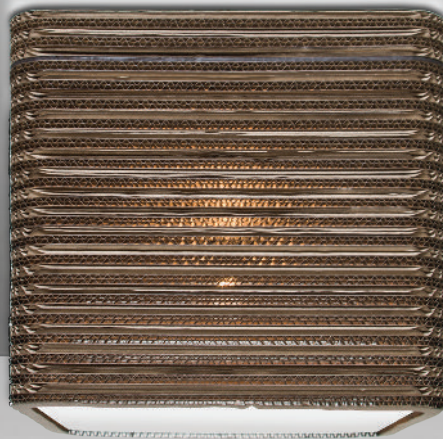

KIRK 12

*\*White Acrylic diffuser can be removed for an optional open bottom appearance.*

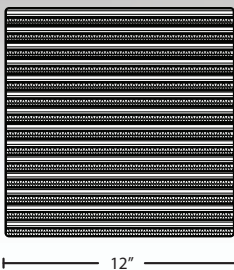

10"

*The urban stylings of our Kirk 12 LED semi-flush mount are ideal for today's modern architecture, composed of intricately cut layers of tan corrugated cardboard.*



**LED:** 9W Replaceable source, 120V, dimmable, 80+ CRI, 3000°K CCT, 800 lumens, 30,000 hours. Lamp included.

**LOCATION: DRY**

FIXTURE/DECOR	LAMP OPTIONS	METAL FINISH
<b>KIRK12C</b> Kirk 12 Corrugated Cardboard	<b>LED</b> 9W LED 120V, dimmable	<b>BR</b> Bronze <b>SN</b> Satin Nickel

**Ex. KIRK12C-LED-SN**  
Kirk 12 Ceiling, Satin Nickel Finish

# 8490 SERIES

## FLUSH MOUNT CEILING



8490CLC  
CLEAR BUBBLE



8490SMC  
SMOKE BUBBLE

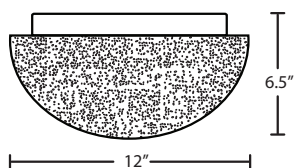

The 8490 Series is a clear semi-flush design composed of a transparent glass diffuser, with an interesting bubble pattern blown randomly throughout the glass.



**STD LAMP:** 60W A19 120V, lamp not included.

**EDI:** 40W Edison, 120V, lamp included.

**EDIL:** 5W Replaceable LED Filament lamp, 120V, dimmable, 80+ CRI, 450 lumens, 15,000 hours, lamp included.

**LOCATION: DAMP, WET WHEN USED WITH COVERED CEILING**

FIXTURE/DECOR	LAMP OPTIONS
8490CLC Clear Bubble	(blank) 60W Incan
8490SMC Smoke Bubble	EDI 40W Edison
	EDIL 5W LED Filament

**Ex. 8490CLC**  
8490 Series Ceiling, Clear Bubble



# CABO

## SCONCES & VANITIES



2WT-962759-CR  
FROST/BUBBLE

1WT-962759-SN  
9.25" L x 5.1" H x 5.5" D



\*Glass shades can be installed vertically on adjustable fitter

2WT-962759-SN  
22" L x 5.1" H x 5.5" D



3WT-962759-SN  
34.75" L x 5.1" H x 5.5" D



The Cabo vanity is a contemporary bath bar featuring handcrafted frosted/bubble glass on a low profile plated bracket, designed to allow for rotation of the glass fitters.



**STD LAMP:** 60W A19 120V, lamp not included.

**LED:** 9W Replaceable source, 120V, dimmable, 80+ CRI, 3000°K CCT, 800 lumens, 30,000 hours. Lamp included.

**LOCATION: DAMP**

FIXTURE	SHADE OPTIONS	LAMP OPTIONS	METAL FINISH
1WT Sconce	962759 Frost/Bubble	(blank) 60W A19 Incan	BR Bronze
2WT 2-Light		LED 9W LED 120V, dimmable	CR Chrome
3WT 3-Light			SN Satin Nickel

**Ex. 2WT-962759-CR**  
Cabo 2-Light Vanity, Frost/Bubble, Chrome Finish



# LIDO

## SCONCES & VANITIES



2WT-888607-SN  
OPAL MATTE



\*Glass shades can be installed vertically on adjustable fitter

1WT-888607-SN  
8.5" L x 4.75" H x 5.25" D



*The Lido vanity is a simple, bath bar featuring handcrafted Opal glass on a low profile plated bracket, designed to allow for rotation of the glass fitters.*



**STD LAMP:** 60W A19 120V, lamp not included.

**LED:** 9W Replaceable source, 120V, dimmable, 80+ CRI, 3000°K CCT, 800 lumens, 30,000 hours. Lamp included.

**LOCATION: DAMP**

2WT-888607-SN  
21" L x 4.75" H x 5.25" D



FIXTURE	SHADE OPTIONS	LAMP OPTIONS	METAL FINISH
1WT Sconce	888607 Opal Matte	(blank) 60W A19 Incan	BR Bronze
2WT 2-Light		LED 9W LED 120V, dimmable	CR Chrome
3WT 3-Light			SN Satin Nickel

3WT-888607-SN  
33.75" L x 4.75" H x 5.25" D



**Ex. 2WT-888607-CR**  
Lido 2-Light Vanity, Opal Matte, Chrome Finish



# BOCA

## SCONCES & VANITIES

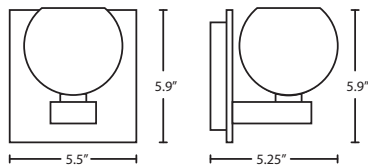

2WF: 14" L x 5.9" H x 5.25" D



3WF: 22" L x 5.9" H x 5.25" D



4WF: 30" L x 5.9" H x 5.25" D





3WF-BOACL-SN w/ S1005-WW ACCESSORY CLEAR

*\*Shown in Satin Nickel finish (SN) and Weathered Wood accessory (S1005-WW)*

*The Boca Vanity is comprised of an appealing globe-shaped clear or bubble-patterned solid glass, accented by an inner frosted tube to diffuse the light source. The wood backplate can be ordered separately to provide warmth to the overall appearance.*



**STD LAMPS:** 40W G9 Halogen, lamp included, suitable for dimming

**LED:** 5W Replaceable source, 120V, dimmable, 80+ CRI, 450 lumens, 3000°K CCT, 30,000 hours.

**LOCATION: DAMP**

FIXTURE	GLASS OPTIONS	LAMP OPTIONS	METAL FINISH
1WF Sconce	BOCABB Clear Bubble	(blank) 40W G9 Hal	BR Bronze
2WF 2-Light	BOACL Clear	LED 5W LED	SN Satin Nickel
3WF 3-Light			
4WF 4-Light			

**Ex. 2WF-BOCABB-SN**  
Boca 2-Light Vanity, Clear Bubble, Satin Nickel

**WOOD BACKPLATE ACCESSORY - WEATHERED WOOD OR EBONY**

- S1003-WW or EB 1 Light Wood Plate, Weathered Wood (WW) or Ebony (EB)
- S1004-WW or EB 2 Light Wood Plate, Weathered Wood (WW) or Ebony (EB)
- S1005-WW or EB 3 Light Wood Plate, Weathered Wood (WW) or Ebony (EB)
- S1006-WW or EB 4 Light Wood Plate, Weathered Wood (WW) or Ebony (EB)



# PHANTOM 6

## SCONCES & VANITIES



PHAN6SC  
SMOKE/CLEAR

PHAN6CL  
CLEAR

PHAN6WC  
WHITE/CLEAR

1WC: 6" L x 9" H x 8.25" D



2WC: 16" L x 9" H x 8.25" D



The Phantom 6 vanity is composed of clear glass bell-shaped shades mounted onto a softly curved flat rail bracket, with an interesting cascading optical pattern blown as an additional transparent layer along the top outer wall of the glass.

**STD. LAMP:** 60W T10 120V, lamp not included.

**EDIL:** 5W Replaceable LED Filament lamp, 120V, dimmable, 80+ CRI, 450 lumens, 15,000 hours, lamp included.

**LOCATION: DAMP**

3WC: 25" L x 9" H x 8.25" D



FIXTURE	SHADE OPTIONS	LAMP OPTIONS	METAL FINISH
1WC Sconce	PHAN6CL Clear	(blank) 60W T10 Incan	BR Bronze
2WC 2-Light	PHAN6SC Smoke/Clear	EDIL 5W LED Filament	SN Satin Nickel
3WC 3-Light	PHAN6WC White/Clear		

**Ex. 1WC-PHAN6SC-BR**  
Phantom 6 Sconce, Smoke/Clear,  
Bronze Finish

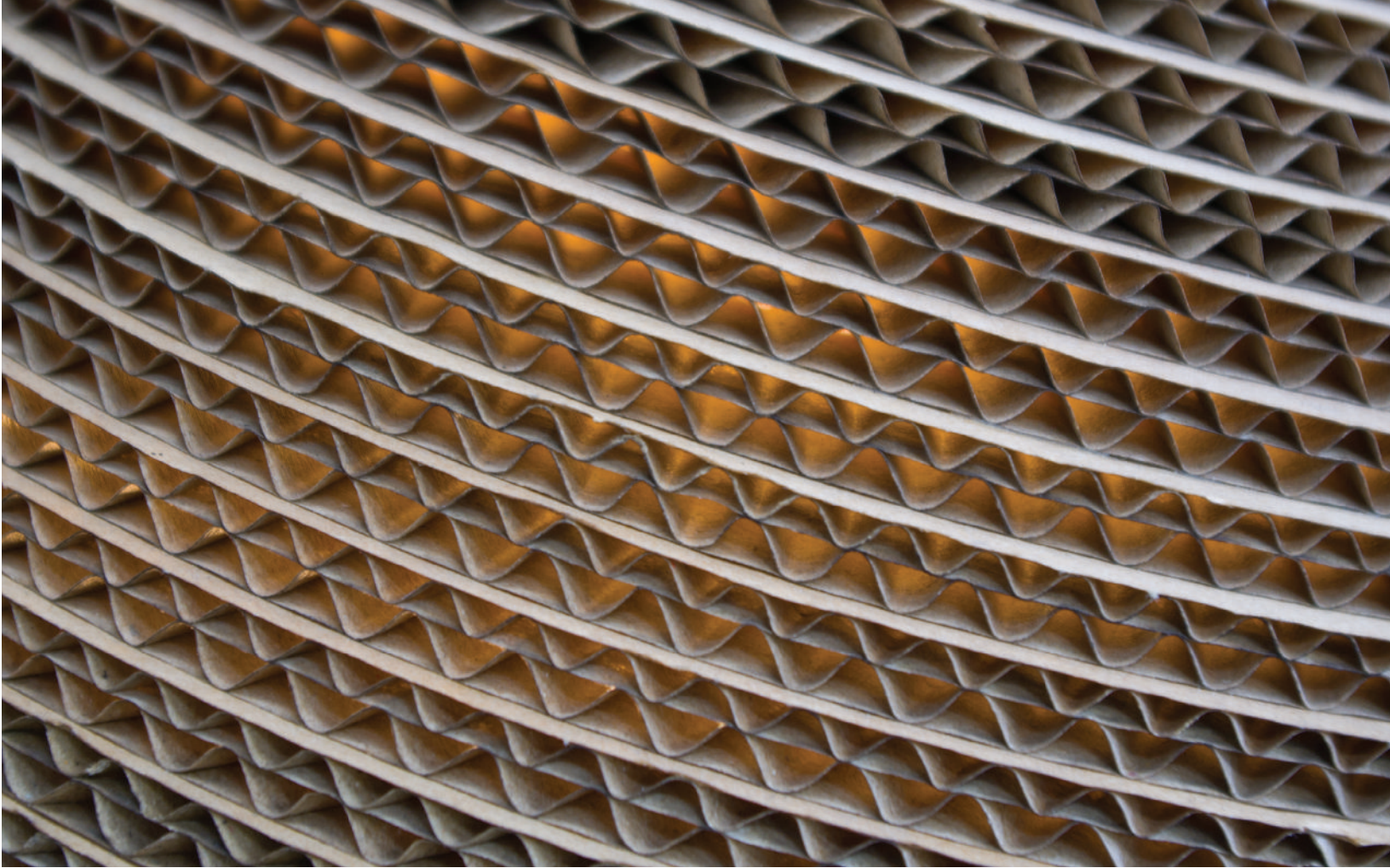

# KIRK 6

## WALL SCONCE



KIRK6

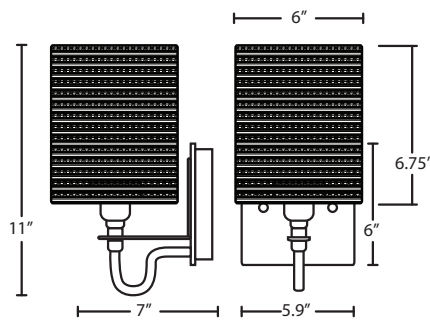

Our geometrically inspired Kirk 6 LED is ideal for urban spaces, composed of intricately cut layers of tan corrugated cardboard, that are fused together in a diminutive cube shade.



**LED:** 5W Replaceable source, 120V, dimmable, 80+ CRI, 450 lumens, 30,000 hours. Lamp included.

**LOCATION:** DRY

FIXTURE	SHADE OPTIONS	LAMP OPTIONS	METAL FINISH
1WG Sconce	KIRK6 Kirk 6 Corrugated Cardboard	LED 5W LED	BK Black

**Ex. 1WG-KIRK6-LED-BK**  
Kirk 6 Sconce, Black Finish





# KILLIAN 26

ADA  
COMPLIANT

## WALL SCONCE

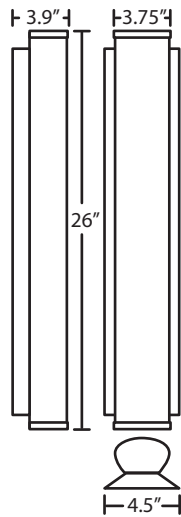

*The visually pleasing Killian wall sconce features a clean tubular satin opal glass diffuser with plated metal endcaps, ideal for vanity applications.*



**STD LAMP:** 3x 40W G9 Halogen, 120V, lamp included.

**FL:** Non-dimming.

**LED:** 5W Replaceable source, 120V, non-dimmable, 80+ CRI, 3000°K CCT, 500 lumens, 30,000 hours, lamp included.

**LOCATION:** DAMP

FIXTURE	LAMP OPTIONS	METAL FINISH
KILLIAN26 Satin White	(blank) 3x 40W G9 Hal 124T5 24W T5 120V/277V LED 3x 5W LED	CR Chrome SN Satin Nickel



KILLIAN26-LED-CR  
CHROME



KILLIAN26-LED-SN  
SATIN NICKEL



# PLATO

## WALL PENDANT



PLATOCL  
CLEAR/OPAL



PLATOSM  
TRANS SMOKE/OPAL  
\* Shown in Bronze finish (BR)

PLATOBL  
TRANS. BLUE/OPAL

PLATOAM  
TRANS. AMBER/OPAL

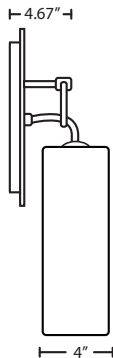
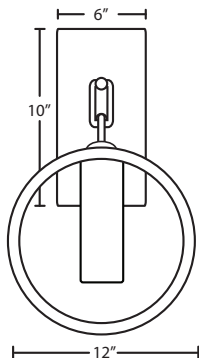

*The Plato is a playful double-glass pendant, with a cylindrical-shaped opal glass centered in a radiused outer transparent glass ring.*



**STD. LAMP:** 60W B10 120V, lamp not included.

**LED:** 5W Replaceable source, 120V, dimmable, 80+ CRI, 300 lumens, 30,000 hours. Lamp included.

**EDI:** 40W Edison S-style lamp, lamp included. (For No Inner (NI) only)

**PLU:** 9W Plumen lamp, lamp included. (For No Inner (NI) only)

**LOCATION: DAMP**

FIXTURE	SHADE OPTIONS	LAMP OPTIONS	METAL FINISH	OPTIONS
1WP Wall Pendant	PLATOAM Trans. Amber/Opal PLATOBL Trans. Blue/Opal PLATOCL Clear/Opal PLATOSM Trans. Smoke/Opal	(blank) 60W Incan LED 5W LED 120V, dimmable EDI 40W Edison (For NI option) PLU 9W Plumen (For NI option)	BR Bronze SN Satin Nickel	NI No Inner Glass

**Ex. 1WP-PLATOCL-SN**  
Plato Wall Pendant, Clear/Opal, Satin Nickel Finish

# 3532 SERIES



## OUTDOOR SCNCE



353299  
BRONZE/SMOKE BUBBLE



353258  
BLACK/SMOKE BUBBLE

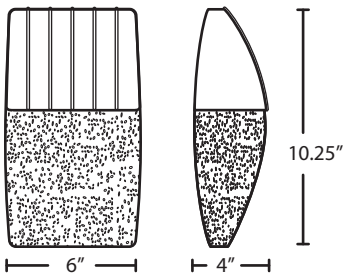

*The 3532 Outdoor Wall fixture is a mid-century sconce design composed of a transparent / painted glass diffuser, with an interesting bubble pattern blown randomly throughout the glass.*



**STD. LAMP:** 75W A19 120V, lamp not included.

Flush mount stainless steel fitter

**LOCATION: WET**

FIXTURE	LAMP OPTIONS
353258 Black/Smoke Bubble	(blank) 75W Incan
353299 Bronze/Smoke Bubble	

# 3534 SERIES

## OUTDOOR SCONCE



353499  
BRONZE/SMOKE BUBBLE



353458  
BLACK/SMOKE BUBBLE

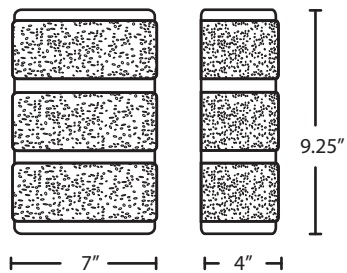

The 3534 Outdoor Wall fixture is a radiused sconce design composed of a transparent/painted glass diffuser, with an interesting bubble pattern blown randomly throughout the glass.

**STD. LAMP:** 75W A19 120V, lamp not included.

Flush mount stainless steel fitter

**LOCATION: WET**



FIXTURE	LAMP OPTIONS
353458 Black/Smoke Bubble	(blank) 75W Incan
353499 Bronze/Smoke Bubble	



# 3533 SERIES



## OUTDOOR SCNCE



35338  
BLACK/SMOKE BUBBLE



35339  
BRONZE/SMOKE BUBBLE

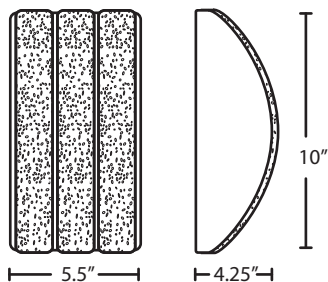

The 3533 Outdoor Wall fixture is a radiused sconce design composed of a transparent/painted glass diffuser, with an interesting bubble pattern blown randomly throughout the glass.



**STD. LAMP:** 75W A19  
120V, lamp not included.

Flush mount stainless steel fitter

**LOCATION: WET**

FIXTURE	LAMP OPTIONS
353358 Black/Smoke Bubble	(blank) 75W Incan
353399 Bronze/Smoke Bubble	

# 3513 SERIES

## OUTDOOR SCNCE



351399-WALL  
BRONZE/SMOKE BUBBLE



351358-POST  
BLACK/SMOKE BUBBLE

3513 Post Mount:

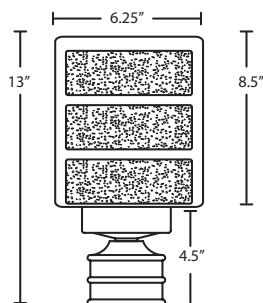

3513 Wall Mount:

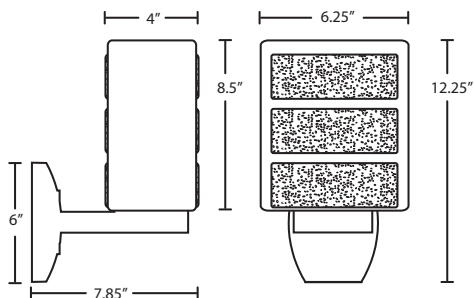

*The 3513 Outdoor wall and post fixtures are a mission style design composed of a transparent/painted glass diffuser, with an interesting bubble pattern blown randomly throughout the glass.*



**STD. LAMP:** 75W A19 120V, lamp not included.

Available with powder coated cast aluminum post fitter or wall bracket. Post fitter is suitable for installation onto a 3" post top (not included).

**LOCATION: WET**

FIXTURE	LAMP OPTIONS	MOUNTING
351358 Black/Smoke Bubble	(blank) 75W Incan	POST Post Fitter
351399 Bronze/Smoke Bubble		WALL Wall Mount





**BESA** LIGHTING

6695 Taylor Rd. Blacklick, OH 43004

tel (614) 762-8900 (800) 446-2372 fax (614) 762-8901

**BESALIGHTING.COM** **FACEBOOK.COM/BESALIGHTING**

Every effort has been made to ensure the accuracy of the information contained within this catalog. We regret any errors, oversights or omissions.

We reserve the right to make any corrections without liability.

Besa Lighting reserves the right to make design changes without prior notice. In the event that design changes are required (in order to comply with regulatory, safety laboratory requirements or due to availability of supplies), Besa assumes no responsibility for the previous design of the modified items should that previous design become unusable or obsolete.

Receipt or possession of this catalog does not constitute an agreement to sell.

All orders between buyer and seller (Besa Lighting Co., Inc.) shall be governed by and construed in accordance with the laws of the State of Ohio, applicable to contracts made and to be performed in that state.

All of the products, images, designs, layouts and text in this catalog are considered the unique intellectual property of Besa Lighting Co., Inc. and are protected by U.S. and international law. Many of the designs shown herein are patented or patent pending. Design infringement will not be tolerated and violators will be prosecuted to the fullest extent of the law.