

MAXIM



LED
COUNTERMAX[®]
STARSTRAND[®]
CONVERT

LED • Under cabinet • Tape • Recessed Lighting



LMXCAT1408

LMXCAT1408



Maxim Lighting's CounterMax® full line of under cabinet lighting fixtures and StarStrand® LED Tape Lighting Systems cast the perfect light throughout the home. In kitchens, granite countertops sparkle under the direct beam and food preparation becomes safer and more enjoyable. In bathrooms and studies, they brighten the room with a warm indirect glow. They even eliminate unwanted shadows in wet bars, curio cabinets, and bookcases with sleek profiles that conceal so discreetly you will never see the source of the gentle light.

COUNTERMAX®

MX-FD Series Direct Wire Fluorescent Under Cabinet Lighting	14
MX-L120DC Series LED Under Cabinet Lighting	10
MX-L120-DL Series LED Under Cabinet Lighting	7
MX-L120-EL Series LED Under Cabinet Lighting	6
MX-L120-LO Series LED Under Cabinet Lighting	5
MX-LD Series LED Discs	17
MX-LD-D Series LED Discs	15
MX-L-LPC Series LED Under Cabinet Lighting	9
MX-X12 Series 12V Xenon Under Cabinet Lighting	13
MX-X120 Series 120V Xenon Under Cabinet Lighting	11
MX-X120c Series Linkable 120V Xenon Under Cabinet Lighting	12
Series Details	19

STARSTRAND®

Aqua Star 24	41
Basic Star 24	23
Channel Star 24	45
Color Flex Star 24	35
Digital Rainbow Star	39
Elite Star 24	31
Glow 24	25
LV Star	22
Rainbow Aqua Star 24	43
Rainbow Channel Star 24	47
Rainbow Dial RGB Controller System	49
Rainbow Star 24	37
Solar Star 24	33
Spec Star	27
Ultima Star 24	29
Maximum Run Chart	59
Drivers	51
Controllers	54
Layout Diagrams	56, 58
Installation and Design Guidelines	57, 58
Kits	50
Displays	61

Recessed Lighting

Diverse Collection	62
Convert Collection	63

COUNTERMAX™

Maxim Lighting's CounterMax under cabinet and puck lights are key ingredients in a home's lighting scheme, providing task lighting and drama to any style living space. CounterMax lighting fixtures work great as concealed task lights, where labor-intensive activities require powerful illumination, such as the utility room, office, kitchen, or craft room. CounterMax comes in your choice of fluorescent, xenon or LED lamping options. The enclosed designs of CounterMax sleek and narrow profile lights make installation easy. To illuminate tighter spaces, CounterMax LED strips work well as accent or indirect lighting, creating beautiful silhouettes and ambiance. CounterMax LED discs focus pools of light for down lighting as exposed or recessed fixtures.

Here are some of the latest techniques to create a stylish and functional lighting scheme with the extensive line of Maxim Lighting's CounterMax fixtures.



Add Spotlight:

Provide a dose of drama by spot lighting the inside of cabinets to reflect off the dishes, glasses or art displayed. Install CounterMax puck lights inside the top cabinets as concealed down lights for even illumination that diffuses as it reflects.



Light Underneath Cabinets: Down light for Dimension:

For food prep areas, install under-cabinet lighting towards the front of the cabinet for the widest beam of light. CounterMax fixtures work well in heat intensive areas, such as the kitchen, because they generate less heat than halogen or xenon bulbs. For stronger light output, consider the CounterMax LED sleek low profile fixture, fully dimmable with an airflow design to keep cabinets cool.



Light Wine Cellars:

CounterMax's line of profile fixtures and discs are ideal for wine cellars, where heat is a concern. To spotlight prized bottles, down light with CounterMax MX-LD-R LED discs that install on the surface or as recessed fixtures with frosted diffusers or CounterMax sleek profile LED discs that can link up to 30 discs without additional hardware. Backlight the cellar with LED strip lights installed behind the wine shelves.

MX-L120-LO SERIES LED Under Cabinet Lighting

COUNTERMAX®

The MX-L120-LO is our economy LED under counter. It features an extruded aluminum body with anodized finishes and a frosted acrylic lens. Its easy mount end caps make for easy and quick installation without the use of clips. Can be direct wired with the use of direct wire box or plugged directly into an outlet.

Features:

- 3000K color temperature
- CRI 80 +
- 40,000 rated life hours
- Linkable end to end or with MX Interlink 5
- Value pricing
- Frosted lens



10" LED Under Cabinet
89901BRZ Anodized Bronze
89901WT White
 10"L x 2"W x 1"H
 Total Wattage 6W
 390 Initial Lumens



Anodized
Bronze



White



21" LED Under Cabinet
89902BRZ Anodized Bronze
89902WT White
 21"L x 2"W x 1"H
 Total Wattage 10W
 650 Initial Lumens



30" LED Under Cabinet
89903BRZ Anodized Bronze
89903WT White
 30"L x 2"W x 1"H
 Total Wattage 12W
 780 Initial Lumens



40" LED Under Cabinet
89904BRZ Anodized Bronze
89904WT White
 40"L x 2"W x 1"H
 Total Wattage 14W
 910 Initial Lumens



MXInterLink5 Direct Wire Box
89958WT White
89958BK Black
 2.75"W x 1"H x 6.5"L



MXInterLink5 Power Cord
89954WT White
89954BK Black
 72"
 Includes on/off switch



Plastic Wire Clip
53255
 .5"W x .25"H x 1"L



MXInterLink5 Connector Cord
 9" **89951WT** White
 9" **89951BK** Black
 18" **89952WT** White
 18" **89952BK** Black
 24" **89953WT** White
 24" **89953BK** Black

The MX-L120-EL features a new edge illuminated technology, which provides even light without the common LED spots on the counter. The enclosed design does not need to be open for either wiring or for mounting. Knockouts for wiring are on a removable plate on the back for quick and easy wiring.

Features:

- 2700K color temperature
- CRI 90 +
- 120° beam spread
- Dimmable using a Lutron® C.L.™ standard dimmer
- 40,000 rated life hours
- Linkable end to end with MX InterLink 4
- No glare lenses



10" LED Under Cabinet

89962AL Brushed Aluminum
89962BRZ Anodized Bronze
89962WT White
10"L x 4"W x 1"H
Total Wattage 1.8W
320 Initial Lumens



13" LED Under Cabinet

89963AL Brushed Aluminum
89963BRZ Anodized Bronze
89963WT White
13"L x 4"W x 1"H
Total Wattage 6.5W
420 Initial Lumens



21" LED Under Cabinet

89964AL Brushed Aluminum
89964BRZ Anodized Bronze
89964WT White
21"L x 4"W x 1"H
Total Wattage 10.5W
680 Initial Lumens



30" LED Under Cabinet

89965AL Brushed Aluminum
89965BRZ Anodized Bronze
89965WT White
30"L x 4"W x 1"H
Total Wattage 15W
975 Initial Lumens



40" LED Under Cabinet

89966AL Brushed Aluminum
89966BRZ Anodized Bronze
89966WT White
40"L x 4"W x 1"H
Total Wattage 20W
1400 Initial Lumens



MX InterLink4 Connector Cord

9" 87876WT White
9" 87876BK Black
18" 87877WT White
18" 87877BK Black
24" 87878WT White
24" 87878BK Black



MX InterLink4 Direct Wire Box

87885WT White
87885BK Black
2.25"W x 1"H x 5"L



MX InterLink4 Power Cord

87880WT White
87880BK Black
72"



Plastic Wire Clip

53255
.5"W x .25"H x 1"L

MX-L120-DL SERIES LED Under Cabinet Lighting

COUNTERMAX®

The MX-L120-DL features a low profile frame and dimming capability, as well as offers increased lumen output. This series is presented with the new LG 5630 LED for closer spacing, better light distribution, and lower operating temperatures for longer life. The hinged top gives access for easy installation with captured mounting and quick wire connectors.



Features:

- 2700K color temperature
- CRI 82
- 120° beam spread
- Dimmable using a Lutron® C.L.™ standard dimmer
- 50,000 rated life hours
- Knockouts are 3/8"
- Includes one Romex connector
- Linkable end to end or with MX InterLink 4
- Frosted glass diffuser



7" LED Under Cabinet
89932MB Metallic Bronze
89932SN Satin Nickel
89932WT White
 7"L x 4"W x 1"H
 Total Wattage 5.1W
 289 Initial Lumens



13" LED Under Cabinet
89933MB Metallic Bronze
89933SN Satin Nickel
89933WT White
 13"L x 4"W x 1"H
 Total Wattage 7.7W
 436 Initial Lumens



21" LED Under Cabinet
89934MB Metallic Bronze
89934SN Satin Nickel
89934WT White
 21"L x 4"W x 1"H
 Total Wattage 10W
 587 Initial Lumens



30" LED Under Cabinet
89936MB Metallic Bronze
89936SN Satin Nickel
89936WT White
 30"L x 4"W x 1"H
 Total Wattage 15W
 882 Initial Lumens



Frost Acrylic Lens
 7" **87892WT** White For 89932
 13" **87893WT** White For 89933
 21" **87894WT** White For 89934
 30" **87896WT** White For 89936



MX InterLink4 Connector Cord
 9" **87876WT** White
 9" **87876BK** Black
 18" **87877WT** White
 18" **87877BK** Black
 24" **87878WT** White
 24" **87878BK** Black



MX InterLink4 Direct Wire Box
87885WT White
87885BK Black
 2.25"W x 1"H x 5"L



MX InterLink4 Power Cord
87880WT White
87880BK Black
 72"



Plastic Wire Clip
53255
 .5"W x .25"H x 1"L

The MX-L120-DL features a low profile frame and dimming capability, as well as offers increased lumen output. This series is presented with the new LG 5630 LED for closer spacing, better light distribution, and lower operating temperatures for longer life. The hinged top gives access for easy installation with captured mounting and quick wire connectors.

Features:

- 3000K color temperature
- CRI 82
- 120° beam spread
- Dimmable using a Lutron[®] C.L.™ standard dimmer
- 50,000 rated life hours
- Knockouts are 3/8"
- Includes one Romex connector
- Linkable end to end or with MX InterLink 4
- Frosted glass diffuser



Metallic Bronze

Satin Nickel

White



7" LED Under Cabinet

89972MB Metallic Bronze
 89972SN Satin Nickel
 89972WT White
 7"L x 4"W x 1"H
 Total Wattage 5.1W
 289 Initial Lumens



13" LED Under Cabinet

89973MB Metallic Bronze
 89973SN Satin Nickel
 89973WT White
 13"L x 4"W x 1"H
 Total Wattage 7.7W
 436 Initial Lumens



21" LED Under Cabinet

89974MB Metallic Bronze
 89974SN Satin Nickel
 89974WT White
 21"L x 4"W x 1"H
 Total Wattage 10W
 587 Initial Lumens



30" LED Under Cabinet

89976MB Metallic Bronze
 89976SN Satin Nickel
 89976WT White
 30"L x 4"W x 1"H
 Total Wattage 15W
 882 Initial Lumens



Plastic Wire Clip
 53255
 .5"W x .25"H x 1"L



MXInterLink4 Power Cord
 87880WT White
 87880BK Black
 72"



MXInterLink4 Direct Wire Box
 87885WT White
 87885BK Black
 2.25"W x 1"H x 5"L



MXInterLink4 Connector Cord
 9" 87876WT White
 9" 87876BK Black
 18" 87877WT White
 18" 87877BK Black
 24" 87878WT White
 24" 87878BK Black



Frost Acrylic Lens
 7" 87892WT White For 89972
 13" 87893WT White For 89973
 21" 87894WT White For 89974
 30" 87896WT White For 89976

The CounterMax MX-L-LPC series, a state-of-the-art low profile LED under cabinet light, installs easily under the cabinet and emits a crisp white light, which illuminates without shadows. Dimmable using a wall dimmer, cabinets stay cool and safe with LED light output. CounterMax MX-L-LPC series is connectable with or without cords using MXInterLink5 technology, making this series convenient, as well as beautiful.



Features:

- 3000K color temperature
- CRI 85
- 120° beam spread
- Dimmable using a Lutron® C.L.™ dimmer
- CREE® LED
- Available in three sizes: 12", 18", and 24"
- Available in three colors: Brushed Aluminum, Anodized Bronze, and White
- Built in driver; No external driver required
- 50,000 rated life hours
- Knockouts are 3/8"
- Includes one Romex connector
- Linkable with or without cord using MX InterLink 5
- Frosted glass diffuser

Patent Pending



12" 4-Light LED Under Cabinet

- 89941AL Brushed Aluminum
- 89941BRZ Anodized Bronze
- 89941WT White
- 12"L x 3"W x .55"H
- Total Wattage 9.89W
- 461 Rated Lumens



18" 6-Light LED Under Cabinet

- 89942AL Brushed Aluminum
- 89942BRZ Anodized Bronze
- 89942WT White
- 18"L x 3"W x .55"H
- Total Wattage 14.74W
- 640 Rated Lumens

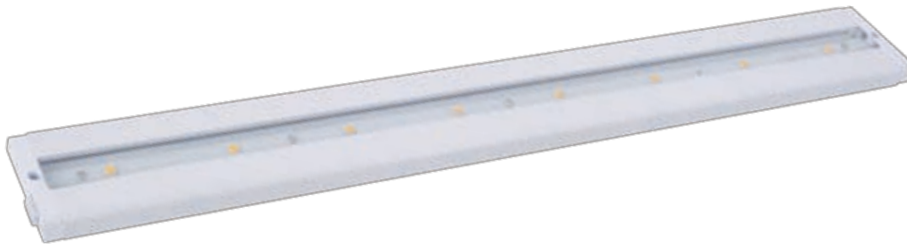

24" 8-Light LED Under Cabinet

- 89943AL Brushed Aluminum
- 89943BRZ Anodized Bronze
- 89943WT White
- 24"L x 3"W x .55"H
- Total Wattage 18.97W
- 903 Rated Lumens



MXInterLink5 Connector Cord

- 9" 89951WT White
- 9" 89951BK Black
- 18" 89952WT White
- 18" 89952BK Black
- 24" 89953WT White
- 24" 89953BK Black



MXInterLink5 Power Cord

- 89954WT White
- 89954BK Black
- 72"
- Includes on/off switch



MXInterLink5 Direct Wire Box

- 89958WT White
- 89958BK Black
- 2.75"W x 1"H x 6.5"L



Plastic Wire Clip

- 53255
- .5"W x .25"H x 1"L

The fully dimmable CounterMax® MX-L120DC is ultramodern with its sleek silhouette, warm white light and direct wiring. Illuminated by Luxeon® 2700K LED, manufactured by Philips, does not cast shadows. The hinged top gives easy access for installation and wiring. Cabinets stay safe and cool to the touch with the dimmable LED light output.

Features:

- 2700K color temperature
- CRI 85
- 120° beam spread
- Dimmable using a Lutron® C.L.™ dimmer
- Cool to touch
- 50,000 rated life hours
- Knockouts are 3/8"
- Includes one Romex connector
- Linkable with or without cord using MX InterLink 4



Metallic Bronze



Satin Nickel



White



7" 2-Light LED Under Cabinet

89922MB Metallic Bronze

89922SN Satin Nickel

89922WT White

7"L x 4"W x 1"H

Total Wattage 4.49W

142 Rated Lumens



13" 4-Light LED Under Cabinet

89923MB Metallic Bronze

89923SN Satin Nickel

89923WT White

13"L x 4"W x 1"H

Total Wattage 9.26W

284 Rated Lumens



21" 6-Light LED Under Cabinet

89924MB Metallic Bronze

89924SN Satin Nickel

89924WT White

21"L x 4"W x 1"H

Total Wattage 13.89W

426 Rated Lumens



30" 8-Light LED Under Cabinet

89926MB Metallic Bronze

89926SN Satin Nickel

89926WT White

30"L x 4"W x 1"H

Total Wattage 18.3W

568 Rated Lumens



MXInterLink4 Connector Cord

9" 87876WT White

9" 87876BK Black

18" 87877WT White

18" 87877BK Black

24" 87878WT White

24" 87878BK Black



MXInterLink4 Direct Wire Box

87885WT White

87885BK Black

2.25"W x 1"H x 5"L



MXInterLink4 Power Cord

87880WT White

87880BK Black

72"



Plastic Wire Clip

53255

.5"W x .25"H x 1"L



Frost Acrylic Lens

7" 87892WT White For 89922

13" 87893WT White For 89923

21" 87894WT White For 89924

30" 87896WT White For 89926

With a sleek profile and direct wiring, this unit installs easily under the cabinet and emits a warm light. The hinged top gives easy access to the long-lasting Xenon bulbs and wiring. Cabinets stay cool and safe, due to the unique airflow design that limits heat transfer.

Features

- 2900K color temperature
- Standard dimmable
- 3,500 rated life hours
- Xenon 120V
- Multiple, full size, 1/2" knockouts
- Push-in wire connectors
- Direct wire installation



Bronze



Satin Nickel



White



7" 1-Light 120V Xenon Under Cabinet
 87830MB Bronze
 87830SN Satin Nickel
 87830WT White
 7"L x 5"W x 1.25"H
 1 x 20W Xenon Bulb (Included)
 225 Rated Lumens

13" 2-Light 120V Xenon Under Cabinet
 87831MB Bronze
 87831SN Satin Nickel
 87831WT White
 13"L x 5"W x 1.25"H
 2 x 20W Xenon Bulb (Included)
 450 Rated Lumens

21" 3-Light 120V Xenon Under Cabinet
 87832MB Bronze
 87832SN Satin Nickel
 87832WT White
 21"L x 5"W x 1.25"H
 3 x 20W Xenon Bulb (Included)
 675 Rated Lumens

30" 4-Light 120V Xenon Under Cabinet
 87833MB Bronze
 87833SN Satin Nickel
 87833WT White
 30"L x 5"W x 1.25"H
 4 x 20W Xenon Bulb (Included)
 900 Rated Lumens

40" 5-Light 120V Xenon Under Cabinet
 87834MB Bronze
 87834SN Satin Nickel
 87834WT White
 40"L x 5"W x 1.25"H
 5 x 20W Xenon Bulb (Included)
 1125 Rated Lumens

With a sleek profile, linkability and direct wiring, this unit installs easily under the cabinet and emits a warm light. The hinged top gives easy access to the long-lasting Xenon bulbs and wiring. Cabinets stay cool and safe, due to the unique airflow design that limits heat transfer.



White



Bronze

Features

- 2900K color temperature
- Standard dimmable
- 3,500 rated life hours
- Xenon 120V
- Full-Size, 1/2" knockouts
- Push-in wire connectors
- Direct wire installation
- Linkable with or without cord using MX InterLink 3



7" 1-Light 120V Xenon Under Cabinet
87840WT White
87840MB Bronze
 7"L x 5"W x 1.25"H
 1 x 20W Xenon Bulb (Included)
 225 Rated Lumens

13" 2-Light 120V Xenon Under Cabinet
87841WT White
87841MB Bronze
 13"L x 5"W x 1.25"H
 2 x 20W Xenon Bulb (Included)
 450 Rated Lumens

21" 3-Light 120V Xenon Under Cabinet
87842WT White
87842MB Bronze
 21"L x 5"W x 1.25"H
 3 x 20W Xenon Bulb (Included)
 675 Rated Lumens

30" 4-Light 120V Xenon Under Cabinet
87843WT White
87843MB Bronze
 30"L x 5"W x 1.25"H
 4 x 20W Xenon Bulb (Included)
 900 Rated Lumens

40" 5-Light 120V Xenon Under Cabinet
87844WT White
87844MB Bronze
 40"L x 5"W x 1.25"H
 5 x 20W Xenon Bulb (Included)
 1125 Rated Lumens

OPTIONAL COMPONENTS



MXInterLink3 Connector Cord
 24" **87858WT** White
 24" **87858BK** Black
 18" **87857WT** White
 18" **87857BK** Black
 9" **87856WT** White
 9" **87856BK** Black



MXInterLink3 Direct Wire Box
 87850WT White
 87850BK Black
 5"W x 1"H x 2.25"L



MXInterLink3 Power Cord
 87860WT White
 87860BK Black
 72"L



Plastic Wire Clip
 53255
 .5"W x .25"H x 1"L

This ultra low-profile design conceals long-lasting, low-voltage xenon bulbs that distribute a crisp bright light. Hinged tops allow for convenient bulb replacement and push-in wire connectors in the junction box make either direct wire or plug-in installation quick and simple.

Features

- 2900K color temperature
- Low voltage dimmable
- 10,000 rated life hours
- Airflow design keeps cabinets cool
- Hi-Low adjustable light level switch
- Linkable with or without cord using MX InterLink 3
- 12V Xenon bulbs included



Bronze

White

Black Accessories White Accessories



Starter Kit Includes:

- One MXInterLink3 Direct Wire Box
- One 18" MXInterLink3 Connector Cord

7" 1-Light 12V Xenon Starter Kit Under Cabinet
 87849WT White
 87849MB Bronze
 7"L x 5"W x 1.13"H
 1 x 18W Xenon Bulb (Included)
 264 Rated Lumens

13" 2-Light 12V Xenon Starter Kit Under Cabinet
 87851WT White
 87851MB Bronze
 13"L x 5"W x 1.13"H
 2 x 18W Xenon Bulb (Included)
 528 Rated Lumens

21" 3-Light 12V Xenon Starter Kit Under Cabinet
 87852WT White
 87852MB Bronze
 21"L x 5"W x 1.13"H
 3 x 18W Xenon Bulb (Included)
 792 Rated Lumens

30" 4-Light 12V Xenon Starter Kit Under Cabinet
 87853WT White
 87853MB Bronze
 30"L x 5"W x 1.13"H
 4 x 18W Xenon Bulb (Included)
 1056 Rated Lumens

ADD - ONS



Slim 1.125" Profile



Xenon

We use 10,000 life hour Xenon Xenon Bulbs

7" 1-Light 12V Xenon Add-On Under Cabinet
 87859WT White
 87859MB Bronze
 7"L x 5"W x 1.13"H
 1 x 18W Xenon Bulb (Included)
 264 Rated Lumens

13" 2-Light 12V Xenon Add-On Under Cabinet
 87861WT White
 87861MB Bronze
 13"L x 5"W x 1.13"H
 2 x 18W Xenon Bulb (Included)
 528 Rated Lumens

21" 3-Light 12V Xenon Add-On Under Cabinet
 87862WT White
 87862MB Bronze
 21"L x 5"W x 1.13"H
 3 x 18W Xenon Bulb (Included)
 792 Rated Lumens

30" 4-Light 12V Xenon Add-On Under Cabinet
 87863WT White
 87863MB Bronze
 30"L x 5"W x 1.13"H
 4 x 18W Xenon Bulb (Included)
 1056 Rated Lumens

OPTIONAL COMPONENTS



MXInterLink3 Direct Wire Box
 87850WT White
 87850BK Black
 5"W x 1"H x 2.25"L



MXInterLink3 Power Cord
 87860WT White
 87860BK Black
 72"L



MXInterLink3 Connector Cord
 24" 87858WT White
 24" 87858BK Black
 18" 87857WT White
 18" 87857BK Black
 9" 87856WT White
 9" 87856BK Black



Plastic Wire Clip
 53255
 .5"W x .25"H x 1"L

This direct wire collection of fluorescent under cabinet lights boasts T5 high lumen technology in sizes from 12" to 43" in length. Full size knockouts allow for easy installation in any application.

Features

- 3100K color temperature
- Non-dimmable
- 7,500 rated life hours
- T5 high lumens technology
- Full size knockouts
- Long life fluorescent lamps

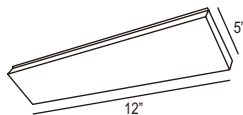

12" 1-Light Fluorescent Under Cabinet
87805WT White
12"L x 5"W x 1.25"H
1 F8 T5 (Included)
400 Rated Lumens

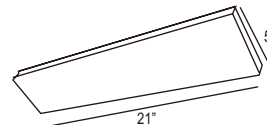

21" 1-Light Fluorescent Under Cabinet
87806WT White
21"L x 5"W x 1.25"H
1 F13 T5 (Included)
870 Rated Lumens

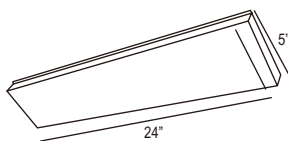

24" 1-Light Fluorescent Under Cabinet
87807WT White
24"L x 5"W x 1.25"H
1 F16 T5 (Included)
1360 Rated Lumens

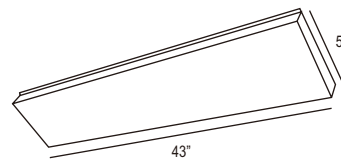

43" 1-Light Fluorescent Under Cabinet
87809WT White
43"L x 5"W x 1.25"H
1 F26 T5 (Included)
2700 Rated Lumens

The versatile CounterMax® MX-LD-D LED disc features two piece aluminum construction that allows for both surface mounting or recessed installation and are designed for daisy chain installation of up to nine discs on one driver with direct-wire installation. MX-LD-D LED discs operate at a fraction of the heat of halogen or xenon discs and consume less than three watts of electricity. When used in conjunction with the available dimmable driver, MX-LD-D LED discs are dimmable using a standard dimmer. This combination of versatility, safety, energy efficiency, and dimmability make the MX-LD-D LED disc the smart choice for disc lighting.

Features

- 3000K color temperature
- Dimmable using a standard dimmer
- 40,000 rated life hours
- Surface or recessed installation
- Two 12" wire leads (Black for Anodized Bronze and Brushed Aluminum finishes, White for White finish)
- Twist lock connectors
- 24 volt low voltage lighting system
- Two piece aluminum construction
- Frosted light guard diffuser
- Mounting screws
- Up to nine MX-LD-D LED discs on a single driver



Brushed Aluminum
53860AL



Anodized Bronze
53860BRZ



White
53860WT

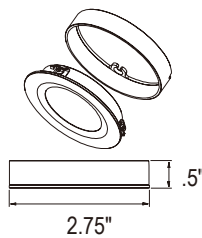

LED Discs

- 53860AL Brushed Aluminum
- 53860BRZ Anodized Bronze
- 53860WT White
- 2.75"W x .5"H
- 1 x 2.3W LED (Integrated)
- 220 Total Rated Lumens

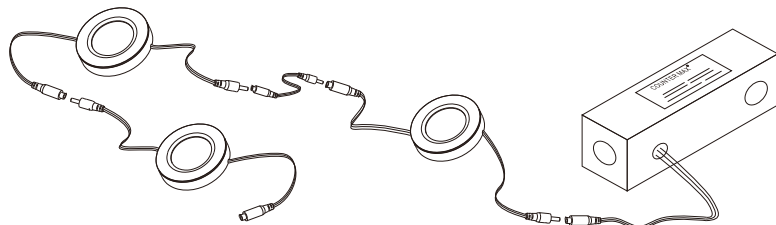



Recessed



Surface



Two piece aluminum construction

3000K Warm White

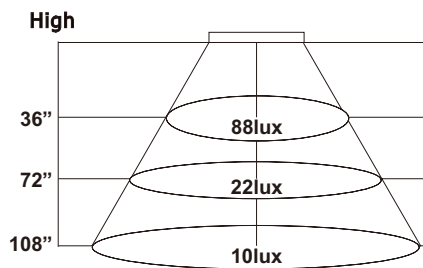

Angular Displacement Degree

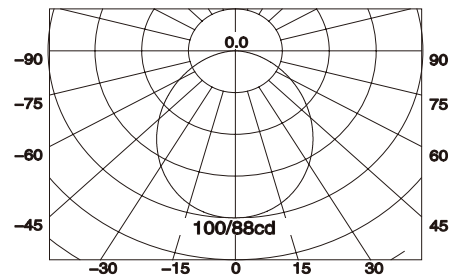

24V 20W Direct Wire Driver

- 53878BK** (Dimmable)
7.75"L x 2"W x 1.25"H
- 110V/277V input
 - 24V, .83A output
 - Operates Up To six MX-LD-D LED discs
 - 72" output cord
 - Direct wire junction box
 - Dimmable using standard dimmer



24V 30W Direct Wire Driver

- 53879BK** (Dimmable)
9.5"L x 2"W x 1.25"H
- 110V/277V input
 - 24V, 1.25A output
 - Operates Up To nine MX-LD-D LED discs
 - 72" output cord
 - Direct wire junction box
 - Dimmable using standard dimmer

Extension Cords

- Extends distance between driver and MX-LD-D LED disc
- Extends distance between any two MX-LD-D LED discs
- Maximum amount of extension cords on a single driver is 120"



- 12" 53868WT White
- 12" 53868BK Black
- 24" 53869WT White
- 24" 53869BK Black

24V 24W Plug-In Driver

53874-DND-24V-24W-PL

- Electronic plug-in driver
- 120V-240V input
- 24V, 1A Output
- Operating temperature 32°F to 104°F
- Includes 60" cord and on-off switch
- Operates up to nine discs



Maxim LED discs mount easily under any cabinet and can link up to 30 discs without additional hardware. The energy efficient LED discs uses only 1.7 watts, requires no additional driver, and stays cool to the touch making it safer than both halogen and xenon. The warm white color lasts long and complements any room.



Features

- 3500K color temperature
- CRI 70-75
- 120° beam spread
- Non-dimmable
- 40,000 rated life hours
- Easy to install
- Cool to the touch polycarbonate housing
- Requires no additional driver
- Expands up to 30 discs



White
White Accessories



Silver
White Accessories



Black
Black Accessories



1-Light Disc Add-On

87881WT White
87881SV Silver
87881BK Black
 3.125"W x .875"H
 1 x 1.7W
 130 Rated Lumens
 Includes One 18" MXInterLink2 Cord
 and Installation Hardware



3-Light Disc Kit

87883WT White
87883SV Silver
87883BK Black
 Total Wattage 5.1W
 390 Rated Lumens

Kit Includes:

- > Three MX-LD LED Discs
- > On/Off Switch
- > Installation Hardware
- > One 72" MXInterLink2 Power Cord
- > Two 18" MXInterLink2 Cords



OPTIONAL COMPONENTS



MXInterLink2 Power Cord
 87817WT White
 87817BK Black
 72"L



MXInterLink2 Coupler
 87820WT White
 87820BK Black
 2"W x .47"H x .5"L



MXInterLink2 Connector Cord
 18" 87819WT White
 18" 87819BK Black
 9" 87818WT White
 9" 87818BK Black



MXInterLink2 Cord Coupler
 87823WT White
 87823BK Black
 .625"W x .375"H x 2.125"L



Plastic Wire Clip
 53255
 .5"W x .25"H x 1"L



MXInterLink2 Direct Wire Box
 87803WT White
 87803BK Black
 2"W x 1"H x 4"L

SERIES DETAILS

COUNTERMAX®

Series	Item	Measurements	Lamping	Lumens	Color Temp	Life Hours	Installation	Replacement Bulb
MX-FD	87805	5"W x 1.25"H x 12"L	1 x 8W Mini Bi Pin T5	400	3100	7500	DW	BUFT508011
	87806	5"W x 1.25"H x 21"L	1 x 13W Mini Bi Pin T5	870	3100	7500	DW	BUFT513012
	87807	5"W x 1.25"H x 24"L	1 x 16W Mini Bi Pin T5	1360	3100	7500	DW	BUFT516013
	87809	5"W x 1.25"H x 43"L	1 x 26W Mini Bi Pin T5	2700	3100	7500	DW	BUFT526015
MX-L120-DL 2700K	89932	4"W x 1"H x 7"L	5.1W LED	289	2700	50000	DW,CP4,DW4,IL4	
	89933	4"W x 1"H x 13"L	7.7W LED	436	2700	50000	DW,CP4,DW4,IL4	
	89934	4"W x 1"H x 21"L	10W LED	587	2700	50000	DW,CP4,DW4,IL4	
	89936	4"W x 1"H x 30"L	15W LED	882	2700	50000	DW,CP4,DW4,IL4	
MX-L120-DL 3000K	89972	4"W x 1"H x 7"L	5.1W LED	289	3000	50000	DW,CP4,DW4,IL4	
	89973	4"W x 1"H x 13"L	7.7W LED	436	3000	50000	DW,CP4,DW4,IL4	
	89974	4"W x 1"H x 21"L	10W LED	587	3000	50000	DW,CP4,DW4,IL4	
	89976	4"W x 1"H x 30"L	15W LED	882	3000	50000	DW,CP4,DW4,IL4	
MX-L120-EL	89962	4"W x 1"H x 10"L	1.8W LED	320	2700	40000	DW,CP4,DW4,IL4	
	89963	4"W x 1"H x 13"L	6.5W LED	420	2700	40000	DW,CP4,DW4,IL4	
	89964	4"W x 1"H x 21"L	10.5W LED	680	2700	40000	DW,CP4,DW4,IL4	
	89965	4"W x 1"H x 30"L	15W LED	975	2700	40000	DW,CP4,DW4,IL4	
	89966	4"W x 1"H x 40"L	20W LED	1400	2700	40000	DW,CP4,DW4,IL4	
MX-L120DC 2700K	89922	4"W x 1"H x 7"L	4.49W LED	142	2700	50000	DW,CP4,DW4,IL4	
	89923	4"W x 1"H x 13"L	9.26W LED	284	2700	50000	DW,CP4,DW4,IL4	
	89924	4"W x 1"H x 21"L	13.89W LED	426	2700	50000	DW,CP4,DW4,IL4	
	89926	4"W x 1"H x 30"L	18.3W LED	568	2700	50000	DW,CP4,DW4,IL4	
MX-L120-LO	89901	2"W x 1"H x 10"L	6W LED	390	3000	40000	DW,CP5,DW5,IL5	
	89902	2"W x 1"H x 21"L	10W LED	650	3000	40000	DW,CP5,DW5,IL5	
	89903	2"W x 1"H x 30"L	12W LED	780	3000	40000	DW,CP5,DW5,IL5	
	89904	2"W x 1"H x 40"L	14W LED	910	3000	40000	DW,CP5,DW5,IL5	

Series	Item	Measurements	Lamping	Lumens	Color Temp	Life Hours	Installation	Replacement Bulb
MX-LD	Single Disc	3.125"W x 0.875"H	1 x 1.7W LED	130	3500	40000	CP2, DW2, IL2	
MX-LD-D	Single Disc	2.75"W x .5"H	1 x 2.3W LED	220	3000	40000	CP	
MX-L-LPC	89941	3"W x 0.55"H x 12"L	9.89W LED	461	3000	50000	CP5, DW5, IL5	
	89942	3"W x 0.55"H x 18"L	14.74W LED	640	3000	50000	CP5, DW5, IL5	
	89943	3"W x 0.55"H x 24"L	18.97W LED	903	3000	50000	CP5, DW5, IL5	
MX-X12	87849/87859	5"W x 1.125"H x 7"L	1 x 18W Wedge T5 Xelogen	264	2900	10000	CP3, DW3, IL3	BUX20023
	87851/87861	5"W x 1.125"H x 13"L	2 x 18W Wedge T5 Xelogen	528	2900	10000	CP3, DW3, IL3	BUX20023
	87852/87862	5"W x 1.125"H x 21"L	3 x 18W Wedge T5 Xelogen	792	2900	10000	CP3, DW3, IL3	BUX20023
	87853/87863	5"W x 1.125"H x 30"L	4 x 18W Wedge T5 Xelogen	1056	2900	10000	CP3, DW3, IL3	BUX20023
MX-X120	87830	5"W x 1.25"H x 7"L	1 x 20W C8	225	2900	3500	DW	BUX20016
	87831	5"W x 1.25"H x 13"L	2 x 20W C8	450	2900	3500	DW	BUX20016
	87832	5"W x 1.25"H x 21"L	3 x 20W C8	675	2900	3500	DW	BUX20016
	87833	5"W x 1.25"H x 30"L	4 x 20W C8	900	2900	3500	DW	BUX20016
	87834	5"W x 1.25"H x 40"L	5 x 20W C8	1125	2900	3500	DW	BUX20016
MX-X120c	87840	5"W x 1.25"H x 7"L	1 x 20W C8	225	2900	3500	DW, CP3, DW3, IL3	BUX20016
	87841	5"W x 1.25"H x 13"L	2 x 20W C8	450	2900	3500	DW, CP3, DW3, IL3	BUX20016
	87842	5"W x 1.25"H x 21"L	3 x 20W C8	675	2900	3500	DW, CP3, DW3, IL3	BUX20016
	87843	5"W x 1.25"H x 30"L	4 x 20W C8	900	2900	3500	DW, CP3, DW3, IL3	BUX20016
	87844	5"W x 1.25"H x 40"L	5 x 20W C8	1125	2900	3500	DW, CP3, DW3, IL3	BUX20016

Cord and Plug

CP - Cord/Plug
 CP2 - MXInterLink2 Cord/Plug
 CP3 - MXInterLink3 Cord/Plug
 CP4 - MXInterLink4 Cord/Plug
 CP5 - MXInterLink5 Cord/Plug

Direct Wire

DW - Direct Wire
 DW2 - MXInterLink2 Direct Wire Box
 DW3 - MXInterLink3 Direct Wire Box
 DW4 - MXInterLink4 Direct Wire Box
 DW5 - MXInterLink5 Direct Wire Box

Link Connector

IL2 - MXInterLink2 Connector Cord
 IL3 - MXInterLink3 Connector Cord
 IL4 - MXInterLink4 Connector Cord
 IL5 - MXInterLink5 Connector Cord

STARSTRAND®

As industry leaders in LED technology, Maxim Lighting is turning wasted space into wow features with the latest LED tape lighting tools. StarStrand LED tape, available in a wide range of color temperatures, from a warm golden glow to sparkling white light, as well as the versatility of the color changing Rainbow strips, provides new opportunities for lighting small spaces, once inaccessible by traditional bulb technology.

Available in 12V and 24V tape and also enclosed as channel lighting, StarStrand's energy-efficient technology provides both practical and artistic illumination. In addition to energy savings, StarStrand is easy to install and works indoors and outdoors to highlight the latest architectural features in home design, such as floating vanities, ceiling coves and recessed walls and niches.



Light Outdoors for Highlight:

LED tape lighting adds architectural dimension to structures, pools, under awnings, fountains, and pergolas. With LED tape, you can conceal the light so not to take away from the style of the structure. Light underneath outdoor furniture to create puddles of colorful light for a nightclub vibe.

Light Coves:

Draw attention to architectural features by lighting a cove or tray ceiling with LED tape to reflect light off the ceiling, giving the illusion of height. Show off artwork with LED tape lights hidden behind a painting.

Light Toe Kicks:

Install LED tape underneath the bottom of base cabinets as toe kick lighting that traces a glowing silhouette and works as a nightlight.

Illuminate Countertops:

Deliver a dose of drama by transforming countertops, wet bars and shelving into tangible light elements. Install LED tape under translucent countertops like onyx, to create a mystic glow. The concealed light source only becomes exposed when switched on.

Features

- 3000K color temperature
- CRI 70-75
- 120° beam spread
- Easy to install, simply plug it in
- Includes AC/DC converter (no driver required)
- Suitable for wet locations (cannot be submersed into water)
- Supplied with one mount clip for every 24"
- Field cut every 20" (cannot be reconnected)

Applications

- Cove and accent lighting
- Outdoor porch and patio
- Pathway lighting
- Backlighting of signs and displays
- Under cabinet lighting

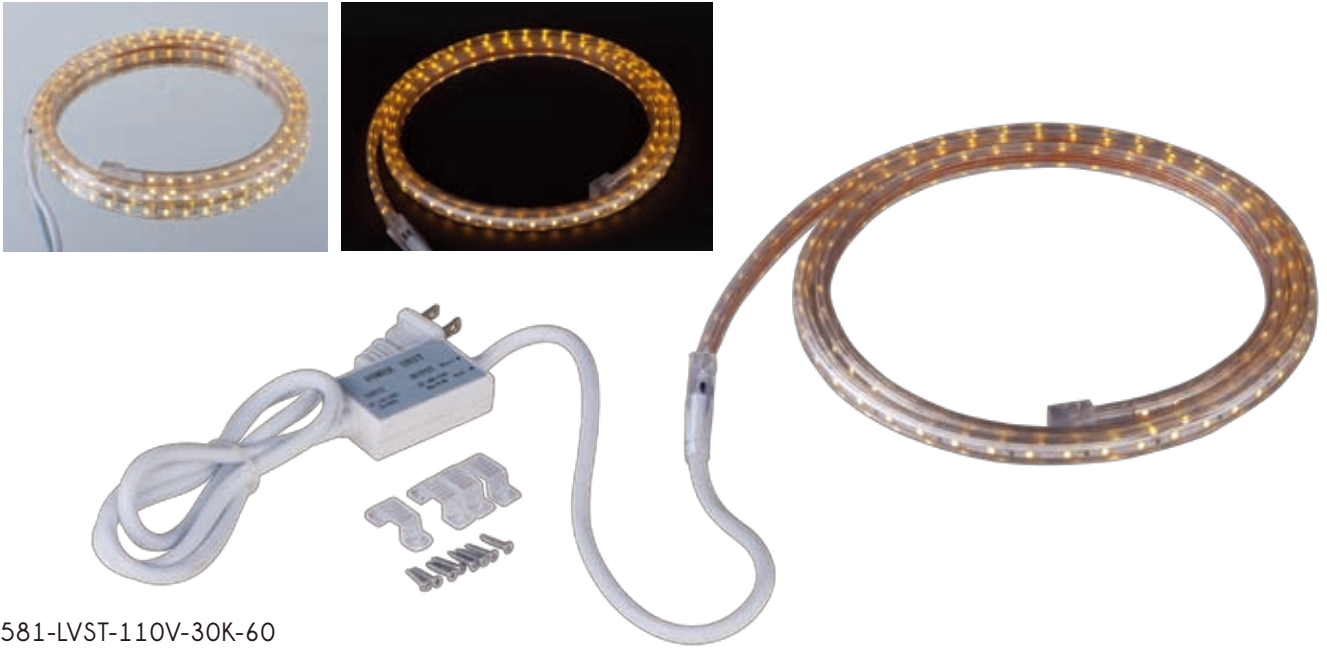

- 53581-LVST-110V-30K-60
- 53582-LVST-110V-30K-120
- 53583-LVST-110V-30K-180
- 53584-LVST-110V-30K-240
- 53585-LVST-110V-30K-300
- 53586-LVST-110V-30K-360
- 53588-LVST-110V-30K-480
- 53590-LVST-110V-30K-600

Item	Length	Diodes	Wattage	Lumens	Color Temp	CRI	PC Board	Beam	Voltage	Current
53581	5'	90	7.2	375	3000K	70 - 75	White	120°	110V	66mA
53582	10'	180	14.4	750	3000K	70 - 75	White	120°	110V	132mA
53583	15'	270	21.6	1125	3000K	70 - 75	White	120°	110V	198mA
53584	20'	360	28.8	1500	3000K	70 - 75	White	120°	110V	264mA
53585	25'	450	36	1875	3000K	70 - 75	White	120°	110V	330mA
53586	30'	540	43.3	2250	3000K	70 - 75	White	120°	110V	396mA
53588	40'	720	57.6	3000	3000K	70 - 75	White	120°	110V	528mA
53590	50'	930	74.4	3875	3000K	70 - 75	White	120°	110V	682mA

Mounting Clips



- 53577**
- Clips x 10 pcs
 - screws x 20 pcs
 - White Box Packing

STARSTRAND® Basic Star 24

Features

- 3000K color temperature
- CRI 70-75
- 120° beam spread
- Low power consumption with 1.4 watts per foot
- 40,000 rated life hours
- Highly flexible material that is backed with 3M adhesive tape for easy installation
- No heat and no UV radiation
- Supplied in 16' 4" continuous lengths and can be field cut every 2" and reconnected as necessary, using specified accessories
- Soldered connectors supplied on each end
- Additional two power feeds and one splicer supplied

Applications

- Cove and toe kick accent lighting
- Cabinet lighting
- Architectural features
- Point of purchase displays
- Backlighting of signs and displays
- Wine cellars
- Closets

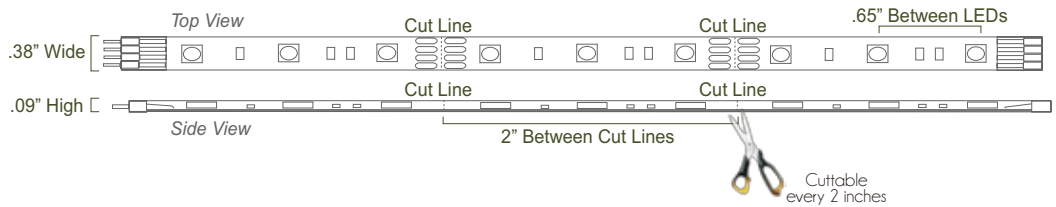

53204-BASI-24V-30K-196

Item	Length	Diodes	Wattage	Lumens	Color Temp	CRI	PC Board	Beam	Voltage	Current
53204	196"	300	19	1350	3000K	70-75	Copper	120°	24V	.8A

Model Number	Wattage	Maximum Run	Wiring Diagram
53324, 53326	30 Watts	22'	7
53313	60 Watts	32'	7

Wiring Diagram on page 56

3000K 120°	
Distance	Foot Candles
12in	16.55
24in	4.61
36in	2.06
48in	1.21

Shown using 1 foot section of Basic Star 24

Rough In Terminal Block



- 53257**
4"L x .75"W x .5"H
- Rough in for new installation construction between 24V Driver and Basic Star 24
 - Female connector on one end with four-wire quick connector on opposite end
 - Includes one 4-Pin Male/Male Adapter and installation screw

End Power Feed



- 53260**
3"L x 1"W x .25"H
- Required if tape is cut
 - Two included with Basic Star 24
 - Female end
 - Package of 6

Flexible Aluminum Channel



- 53254**
36"L x .5"W x .6"H
- Creates valance to conceal tape
 - Irregular surfaces installation
 - Includes screws for installation

4-Pin 4-Way Connector



- 53263**
1.5"L x 1.5"W x .25"H
- Allows for L, T, and X installations between 24V Driver and Basic Star 24
 - Creates a power block for branching between 24V Drivers and Basic Star 24
 - Includes two 4-Pin Male End Caps and one 4-Pin Male/Male Adapter

45° Angle Mounting Channel



- 53374**
48"L x 1"W x .75"H
- Surface mount to angle tape for accent lighting
 - Aluminum screws included

4-Pin Silicone End Cap

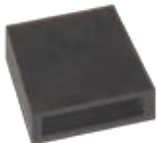

- 53269**
.75"L x .5"W x .1"H
- Placed on run termination
 - Protects against dust and damage
 - Package of 10

Flexible Connector



- 53259**
3"L x 1"W x .25"H
- Use for corners and angles
 - Package of 6

Drivers

(See page 51-52 for detailed driver information)

- 53324** 24V 30W Class II Driver
53326 24V 30W Class II Dimmable Driver
53313 24V 60W Class II Plug In Driver

4-Pin Connecting Cords



- 53265** 3"L x .5"W x .25"H
53266 7"L x .5"W x .25"H
53267 13"L x .5"W x .25"H
53268 73"L x .5"W x .25"H
- Extends distance between 24V Driver and Basic Star 24
 - Connect sections of Basic Star 24 together

Tape Splicer



- 53261**
1"L x .5"W x .25"H
- Joins two sections, if tape is cut
 - One included with Basic Star 24
 - Package of 10

4-Pin Male/Male Adapter

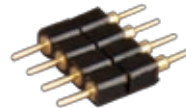

- 53262**
.5"L x .5"W x .25"H
- Changes female end of Basic Star 24 to male end
 - Package of 10

Plastic Wire Clip



- 53255**
1"L x .5"W x .25"H
- Secures to surface connecting cords and input/output cords of drivers, controllers, and amplifiers
 - Backed with 3M adhesive
 - Package of 10

Heat Shrink Wrap



- 53256**
3"L x 1"W x .25"H
- Secures connections when in walls
 - Waterproof for damp locations
 - Heat gun required for installation
 - Package of 10

Aluminum Channel



- 53373**
60"L x .75"W x .75"H
- Can be recessed or surface mounted
 - Aluminum screws included

STARSTRAND® Glow 24

Features

- 2700K or 3000K color temperature
- CRI 80
- 120° beam spread
- Two dimmable driver options
- 40,000 rated life hours
- Low power consumption with 2.78 watts per foot
- Highly flexible material that is backed with 3M adhesive tape for easy installation
- No heat and no UV radiation
- Supplied in 35 sections of 12" each, that can be field cut every 6"
- Soldered connectors supplied on each end

Applications

- Cove and toe kick accent lighting
- Cabinet lighting
- Architectural features
- Backlighting of signs and displays
- Wine cellars
- Closets

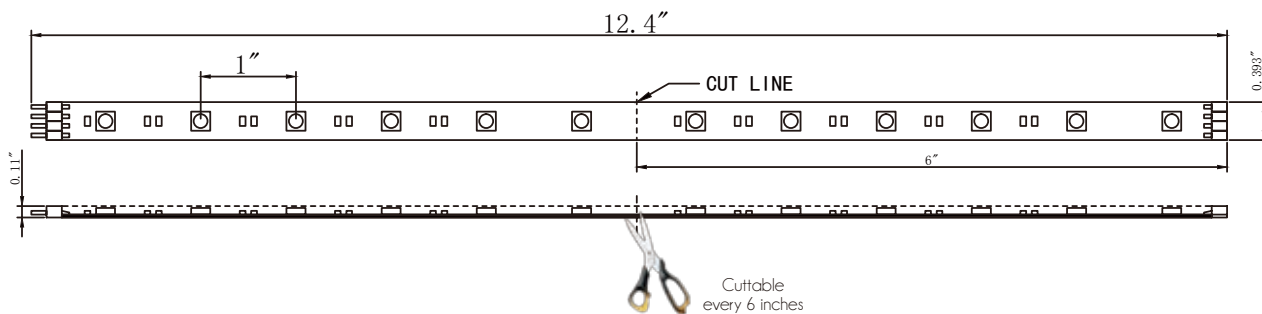

53206-SP-LED-GLOW-24V-27K-420

53207-SP-LED-GLOW-24V-30K-420

Item	Length	Diodes	Wattage	Lumens	Color Temp	CRI	PC Board	Beam	Voltage	Current
53206	420"	420	97.3	7000	2700K	80	White	120°	24V	4.2A
53207	420"	420	97.3	7175	3000K	80	White	120°	24V	4.2A

4-Pin 4-Way Connector



- 53263**
1.5"L x 1.5"W x .25"H
- Allows for L, T, and X installations between 24V Driver and Glow 24
 - Creates a power block for branching between 24V Drivers and Glow 24
 - Includes two 4-Pin Male End Caps and one 4-Pin Male/Male Adapter

Flexible Aluminum Channel



- 53254**
36"L x .5"W x .6"H
- Creates valance to conceal tape
 - Irregular surfaces installation
 - Includes screws for installation

4-Pin Mounting Clip



- 53272**
.5"L x .5"W x .25"H
- Use on irregular surfaces when adhesive backing is not sufficient
 - Recommended interval is every 12"
 - Package of 20

45° Angle Mounting Channel



- 53374**
48"L x 1"W x .75"H
- Surface mount to angle tape for accent lighting
 - Aluminum screws included

4-Pin Silicone End Cap

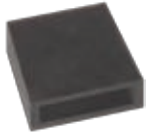

- 53269**
.75"L x .5"W x .1"H
- Placed on run termination
 - Protects against dust and damage
 - Package of 10

4-Pin Connecting Cords



- 53265** 3"L x .5"W x .25"H
53266 7"L x .5"W x .25"H
53267 13"L x .5"W x .25"H
53268 73"L x .5"W x .25"H
- Extends distance between 24V Driver and Glow 24
 - Connect sections of Glow 24 together

Drivers

(See page 52 for detailed driver information)

- 53323** 24V 30W Dimmable Driver in Wire Box (Maximum Run 10')
53332 24V 100W Dimmable Driver (Maximum Run 35')

Rough In Terminal Block



- 53257**
4"L x .75"W x .5"H
- Rough in for new installation construction between 24V Driver and Glow 24
 - Female connector on one end with four-wire quick connector on opposite end
 - Includes one 4-Pin Male/Male Adapter and installation screw

4-Pin Male/Male Adapter

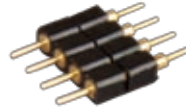

- 53262**
.5"L x .5"W x .25"H
- Changes female end of Glow 24 to male end
 - Package of 10

Plastic Wire Clip



- 53255**
1"L x .5"W x .25"H
- Secures to surface connecting cords and input/output cords of drivers, controllers, and amplifiers
 - Backed with 3M adhesive
 - Package of 10

Heat Shrink Wrap



- 53256**
3"L x 1"W x .25"H
- Secures connections when in walls
 - Waterproof for damp locations
 - Heat gun required for installation
 - Package of 10

4-Pin Male End Cap



- 53264**
.5"L x .5"W x .10"H
- Placed on female end of run termination
 - Protects against dust and damage
 - Package of 10

STARSTRAND® Spec Star

Features

- 3300K color temperature
- CRI 97+
- 120° beam spread
- Non-dimmable
- 60,000 rated life hours
- Superior quality Seoul Semiconductor LED
- High lumens
- Heat sink included for 24/7 operation
- UL approved for damp locations

Applications

- Retail display
- Walkway lighting
- Work areas
- Accent lighting
- Counter lighting

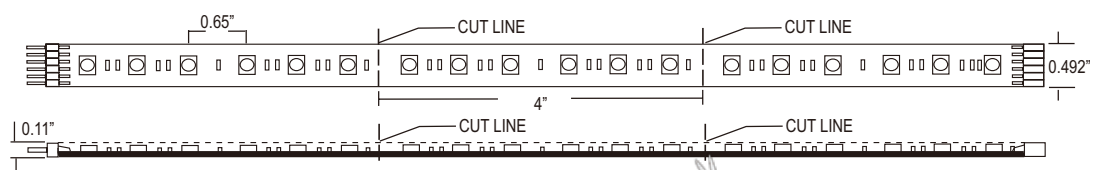
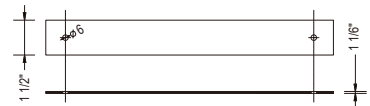

- 53570-SPEC-24V-33K-4
- 53571-SPEC-24V-33K-12
- 53572-SPEC-24V-33K-60
- 53574-SPEC-24V-33K-120
- 53575-SPEC-24V-33K-240

Item	Length	Diodes	Wattage	Lumens	Color Temp	CRI	PC Board	Beam	Voltage	Current
53570	4"	6	1.44	102	3300K	97+	White	120°	24V	60mA
53571	12"	18	4.3	307	3300K	97+	White	120°	24V	180mA
53572	60"	90	21.5	1535	3300K	97+	White	120°	24V	900mA
53574	120"	180	43	3070	3300K	97+	White	120°	24V	1.8A
53575	240"	360	86	6140	3300K	97+	White	120°	24V	3.6A

Model Number	Wattage	Maximum Run	Wiring Diagram	Drivers
53324, 53326	30 Watts	6'	1	(See page 51-52 for detailed driver information) 53324 24V 30W Class II Driver 53326 24V 30W Dimmable Driver 53313 24V 60W Plug-In Driver 53318 24V 60W Class II Driver 53286 24V 96W Class II Driver 53330 24V 100W Dimmable Driver 53331 24V 100W Dimmable Driver 277V
53313, 53318	60 Watts	12'	1	
53286	96 Watts	22'	1	
53330, 53331	100 Watts	22'	1	
Wiring Diagram on page 56				



6-Pin 4-Way Connector



53350
 1.5"L x 1.5"W x .25"H
 · Creates a power block for branching between Spec Star, 24V Driver or 24V Dimming Controller
 · Includes two 6-Pin Male End Caps, one 6-Pin Male/Male Adapter, and one Male Extender

6-Pin Rough-In Terminal Block



53258
 4"L x .75"W x .5"H
 · Rough in for new installation construction between Spec Star, 24V Driver or 24V Dimming Controller
 · Female connector on one end with two wire quick connectors on opposite end
 · Includes one 6-Pin Male/Male Adapter and installation screw

6-Pin Connecting Cords



53465 5"L x .75"W x .25"H
53467 13"L x .75"W x .25"H
53468 73"L x .75"W x .25"H
 · Extends distance between Spec Star, 24V Driver or 24V Dimming Controller

6-Pin 90° Connector



53464
 1.25"L x 1.25"W x .25"H
 · For 90° corners
 · Reversible for left or right
 · Includes 3M adhesive for easy mounting

6-Pin Male/Male Adapter



53342
 .5"L x .5"W x .25"H
 · Changes female end to male
 · Package of 6

Adjustable 6-Pin Connector



53462
 1.18"W x .25"H x 2.3"L
 · Used for irregular turns on a flat surface
 · Adjusts from 90° to 180°
 · Great for radius turn alcoves

Plastic Wire Clip



53255
 1"L x .5"W x .25"H
 · Secures to surface connecting cords and input/output cords of drivers and controllers
 · Backed with 3M adhesive
 · Package of 10

6-Pin Male Extender



53341
 .5"L x .5"W x .25"H
 · Used to connect 6-Pin 4-Way Connector to 6-Pin Connecting Cords and the 6-Pin output cords on 24V drivers and 24V Dimming Controller
 · Package of 6
 · One included with 53350

Heat Shrink Wrap



53256
 3"L x 1"W x .25"H
 · Secures connections when in walls
 · Waterproof for damp locations
 · Heat gun required for installation
 · Package of 10

6-Pin Silicone End Cap



53469
 .75"L x .5"W x .1"H
 · Placed on run termination
 · Protects against dust and damage
 · Package of 10

6-Pin Male End Cap



53344
 .5"L x .5"W x .25"H
 · Placed on female end of run termination
 · Protects against dust and damage
 · Package of 6

6-Pin Mounting Clip



53273
 .5"W x .25"H x .5"L
 · Use on irregular surfaces when adhesive backing is not sufficient
 · Recommended interval is every 12"
 · Package of 20

STARSTRAND® Ultima Star 24

Features

- 3500K color temperature
- CRI 70-75
- 120° beam spread
- Magnetic low-voltage dimmer
- 30,000 rated life hours
- Highly flexible material that is backed with 3M adhesive tape for easy installation
- Highest StarStrand lumen light output
- Long runs up to 100'
- Silicone covered to reduce static failure
- Multiple lengths with soldered connectors for trouble free installation
- UL approved for Damp locations
- Field cuttable every 4"

Applications

- Office task lighting
- Under cabinet lighting
- Closets
- Work areas
- Display counters
- Steps and railings

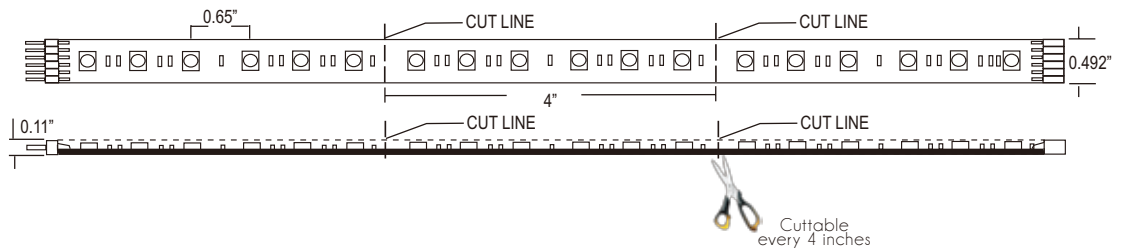

- 53450-ULTI-24V-35K-4
- 53451-ULTI-24V-35K-12
- 53452-ULTI-24V-35K-60
- 53453-ULTI-24V-35K-120
- 53454-ULTI-24V-35K-240
- 53455-ULTI-24V-35K-20

Item	Length	Diodes	Wattage	Lumens	Color Temp	CRI	PC Board	Beam	Voltage	Current
53450	4"	6	1.23	85	3500K	70-75	White	120°	24V	51mA
53451	12"	18	3.7	254	3500K	70-75	White	120°	24V	154mA
53455	20"	30	6.17	423	3500K	70-75	White	120°	24V	257mA
53452	60"	90	18.5	1270	3500K	70-75	White	120°	24V	771mA
53453	120"	180	37	2540	3500K	70-75	White	120°	24V	1.5A
53454	240"	360	74	5080	3500K	70-75	White	120°	24V	3.1A

Model Number	Wattage	Maximum Run	Maximum Run Using 2 Output Cords	Wiring Diagram
53324, 53326	30 Watts	8'	1
53313, 55318	60 Watts	13'	1
53286	96 Watts	22'	1
53330, 53331	100 Watts	22'	1
53287	150 Watts	32'	1
53288	320 Watts	50'	70'
53289	480 Watts	50'	100'

3500K 120°	
Distance	Foot Candles
12in	51.47
24in	14.47
36in	6.65
48in	3.85

Wiring Diagram on page 56 Shown using 1 foot section of Ultima Star 24

6-Pin 4-Way Connector



- 53350**
1.5"L x 1.5"W x .25"H
- Creates a power block for branching between Ultima Star 24, 24V Driver, or 24V Dimming Controller
 - Includes two 6-Pin Male End Caps, one 6-Pin Male/Male Adapter, and one Male Extender

6-Pin Male Extender



- 53341**
.5"L x .5"W x .25"H
- Used to connect 6-Pin 4-Way Connector to 6-Pin Connecting Cords and the 6-Pin output cords on 24V drivers and 24V Dimming Controller
 - Package of 6
 - One included with 53350

6-Pin Connecting Cords



- 53465** 5"L x .75"W x .25"H
53467 13"L x .75"W x .25"H
53468 73"L x .75"W x .25"H
- Extends distance between Ultima Star 24, 24V Driver, or 24V Dimming Controller

6-Pin 90° Connector



- 53464**
1.25"L x 1.25"W x .25"H
- For 90° corners
 - Reversible for left or right
 - Includes 3M adhesive for easy mounting

Flexible Aluminum Channel



- 53254**
36"L x .5"W x .6"H
- Creates valance to conceal tape
 - Irregular surfaces installation
 - Includes screws for installation

6-Pin Male/Male Adapter



- 53342**
.5"L x .5"W x .25"H
- Changes female end to male
 - Package of 6

Adjustable 6-Pin Connector



- 53462**
1.18"W x .25"H x 2.3"L
- Used for irregular turns on a flat surface
 - Adjusts from 90° to 180°
 - Great for radius turn alcoves

Drivers

(See page 51-52 for detailed driver information)

53324	24V 30W Class II Driver	53330	24V 100W Dimmable Driver
53326	24V 30W Dimmable Driver	53331	24V 100W Dimmable Driver 277V
53313	24V 60W Plug-In Driver	53287	24V 150W Driver
53318	24V 60W Class II Driver	53288	24V 320W Driver
53286	24V 96W Class II Driver	53289	24V 480W Driver

Plastic Wire Clip



- 53255**
1"L x .5"W x .25"H
- Secures to surface connecting cords and input/output cords of drivers and controllers
 - Backed with 3M adhesive
 - Package of 10

6-Pin Rough-In Terminal Block



- 53258**
4"L x .75"W x .5"H
- Rough in for new installation construction between Ultima Star 24, 24V Driver or 24V Dimming Controller
 - Female connector on one end with two wire quick connectors on opposite end
 - Includes one 6-Pin Male/Male Adapter and installation screw

6-Pin Mounting Clip



- 53273**
.5"W x .25"H x .5"L
- Use on irregular surfaces when adhesive backing is not sufficient
 - Recommended interval is every 12"
 - Package of 20

6-Pin Silicone End Cap

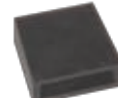

- 53469**
.75"L x .5"W x .1"H
- Placed on run termination
 - Protects against dust and damage
 - Package of 10

Heat Shrink Wrap



- 53256**
3"L x 1"W x .25"H
- Secures connections when in walls
 - Waterproof for damp locations
 - Heat gun required for installation
 - Package of 10

6-Pin Male End Cap



- 53344**
.5"L x .5"W x .25"H
- Placed on female end of run termination
 - Protects against dust and damage
 - Package of 6

STARSTRAND® Elite Star 24

Features

- 3500K color temperature
- CRI 70-75
- 120° beam spread
- Magnetic low-voltage dimmer
- 30,000 rated life hours
- High lumen light output
- Long runs up to 150'
- Silicone covered to reduce static failure
- Multiple lengths with soldered connectors for trouble free installation
- Highly flexible material that is backed with 3M adhesive tape for easy installation
- UL approved for Damp locations
- Field cuttable every 4"

Applications

- Cove and toe kick accent lighting
- Outdoor covered porch and patio
- Under cabinet lighting
- Step lighting
- Restaurants and lounges
- Boats and RV

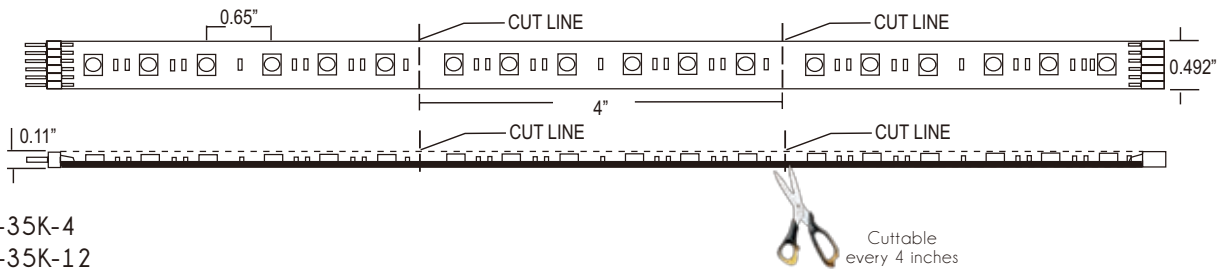

- 53430-ELIT-24V-35K-4
- 53431-ELIT-24V-35K-12
- 53432-ELIT-24V-35K-60
- 53433-ELIT-24V-35K-120
- 53434-ELIT-24V-35K-240

Item	Length	Diodes	Wattage	Lumens	Color Temp	CRI	PC Board	Beam	Voltage	Current
53430	4"	6	0.9	43	3500K	70-75	Black	120°	24V	38mA
53431	12"	18	2.7	130	3500K	70-75	Black	120°	24V	113mA
53432	60"	90	13.5	650	3500K	70-75	Black	120°	24V	563mA
53433	120"	180	27	1300	3500K	70-75	Black	120°	24V	1.1A
53434	240"	360	54	2600	3500K	70-75	Black	120°	24V	2.3A

Model Number	Wattage	Maximum Run	Maximum Run Using 2 Output Cords	Wiring Diagram
53324, 53326	30 Watts	11'	1
53313, 55318	60 Watts	20'	1
53286	96 Watts	33'	1
53330, 53331	100 Watts	33'	1
53287	150 Watts	50'	1
53288	320 Watts	75'	105'
53289	480 Watts	75'	150'

3500K 120°	
Distance	Foot Candles
12in	23.78
24in	6.77
36in	3.12
48in	1.83

Shown using 1 foot section of Elite Star 24

Wiring Diagram on page 56

6-Pin 4-Way Connector



- 53350**
1.5"L x 1.5"W x .25"H
- Creates a power block for branching between Elite Star 24, 24V Driver, or 24V Dimming Controller
 - Includes two 6-Pin Male End Caps and one 6-Pin Male/Male Adapter and one Male Extender

6-Pin Male Extender



- 53341**
.5"L x .5"W x .25"H
- Used to connect 6-Pin 4-Way Connector to 6-Pin Connecting Cords and the 6-Pin output cords on 24V drivers and 24V Dimming Controller
 - Package of 6
 - One included with 53350

6-Pin Connecting Cords



- 53465** 5"L x .75"W x .25"H
53467 13"L x .75"W x .25"H
53468 73"L x .75"W x .25"H
- Extends distance between Elite Star 24, 24V Driver, or 24V Dimming Controller

6-Pin 90° Connector



- 53464**
1.25"L x 1.25"W x .25"H
- For 90° corners
 - Reversible for left or right
 - Includes 3M adhesive for easy mounting

Flexible Aluminum Channel



- 53254**
36"L x .5"W x .6"H
- Creates valance to conceal tape
 - Irregular surfaces installation
 - Includes screws for installation

6-Pin Male/Male Adapter



- 53342**
.5"L x .5"W x .25"H
- Changes female end to male
 - Package of 6

Adjustable 6-Pin Connector



- 53462**
1.18"W x .25"H x 2.3"L
- Used for irregular turns on a flat surface
 - Adjusts from 90° to 180°
 - Great for radius turn alcoves

Plastic Wire Clip



- 53255**
1"L x .5"W x .25"H
- Secures to surface connecting cords and input/output cords of drivers and controllers
 - Backed with 3M adhesive
 - Package of 10

6-Pin Rough-In Terminal Block



- 53258**
4"L x .75"W x .5"H
- Rough in for new installation construction between Elite Star 24, 24V Driver or 24V Dimming Controller
 - Female connector on one end with two wire quick connector on opposite end
 - Includes one 6-Pin Male/Male Adapter and installation screw

6-Pin Mounting Clip



- 53273**
.5"W x .25"H x .5"L
- Use on irregular surfaces when adhesive backing is not sufficient
 - Recommended interval is every 12"
 - Package of 20

6-Pin Silicone End Cap

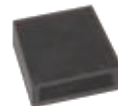

- 53469**
.75"L x .5"W x .1"H
- Placed on run termination
 - Protects against dust and damage
 - Package of 10

Heat Shrink Wrap



- 53256**
3"L x 1"W x .25"H
- Secures connections when in walls
 - Waterproof for damp locations
 - Heat gun required for installation
 - Package of 10

6-Pin Male End Cap



- 53344**
.5"L x .5"W x .25"H
- Placed on female end of run termination
 - Protects against dust and damage
 - Package of 6

Drivers

(See page 51-52 for detailed driver information)

53324	24V 30W Class II Driver	53330	24V 100W Dimmable Driver
53326	24V 30W Dimmable Driver	53331	24V 100W Dimmable Driver 277V
53313	24V 60W Plug-In Driver	53287	24V 150W Driver
53318	24V 60W Class II Driver	53288	24V 320W Driver
53286	24V 96W Class II Driver	53289	24V 480W Driver

STARSTRAND® Solar Star 24

Features

- 2700K color temperature
- CRI 82
- 120° beam spread
- Magnetic low-voltage dimmer
- 40,000 rated life hours
- Highly flexible material that is backed with 3M adhesive tape for easy installation
- Highest StarStrand lumen light output
- Long runs up to 100'
- Silicone covered to reduce static failure
- Multiple lengths with soldered connectors for trouble free installation
- UL approved for damp locations
- Field cuttable every 4"

Applications

- Office task lighting
- Under cabinet lighting
- Closets
- Work areas
- Display counters
- Steps and railings

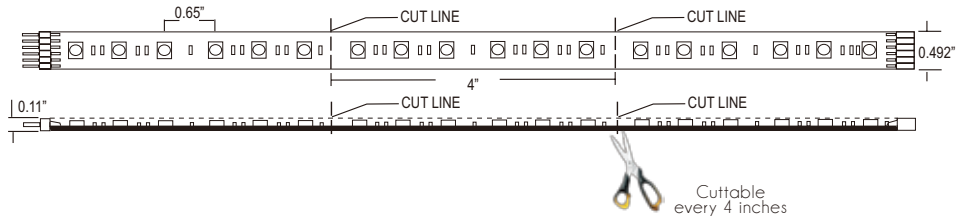

- 53470-SOLA-24V-27K-4
- 53471-SOLA-24V-27K-12
- 53472-SOLA-24V-27K-60
- 53473-SOLA-24V-27K-120
- 53474-SOLA-24V-27K-240

Item	Length	Diodes	Wattage	Lumens	Color Temp	CRI	PC Board	Beam	Voltage	Current
53470	4"	6	1.23	80	2700K	82	Black	120°	24V	51mA
53471	12"	18	3.7	239	2700K	82	Black	120°	24V	154mA
53472	60"	90	18.5	1195	2700K	82	Black	120°	24V	770mA
53473	120"	180	37	2390	2700K	82	Black	120°	24V	1.5A
53474	240"	360	74	4780	2700K	82	Black	120°	24V	3.1A

Model Number	Wattage	Maximum Run	Maximum Run Using 2 Output Cords	Wiring Diagram
53324, 53326	30 Watts	8'	1
53313, 55318	60 Watts	13'	1
53286	96 Watts	22'	1
53330, 53331	100 Watts	22'	1
53287	150 Watts	32'	1
53288	320 Watts	50'	70'
53289	480 Watts	50'	100'

2700K 120°	
Distance	Foot Candles
12in	51.47
24in	14.47
36in	6.65
48in	3.85

Wiring Diagram on page 56

Shown using 1 foot section of Solar Star 24

6-Pin 4-Way Connector



- 53350**
 1.5"L x 1.5"W x .25"H
- Creates a power block for branching between Solar Star 24, 24V Driver, or 24V Dimming Controller
 - Includes two 6-Pin Male End Caps and one 6-Pin Male/Male Adapter and one Male Extender

6-Pin Male Extender



- 53341**
 .5"L x .5"W x .25"H
- Used to connect 6-Pin 4-Way Connector to 6-Pin Connecting Cords and the 6-Pin output cords on 24V drivers and 24V Dimming Controller
 - Package of 6
 - One included with 53350

6-Pin Connecting Cords



- 53465** 5"L x .75"W x .25"H
53467 13"L x .75"W x .25"H
53468 73"L x .75"W x .25"H
- Extends distance between Solar Star 24, 24V Driver, or 24V Dimming Controller

6-Pin 90° Connector



- 53464**
 1.25"L x 1.25"W x .25"H
- For 90° corners
 - Reversible for left or right
 - Includes 3M adhesive for easy mounting

Flexible Aluminum Channel



- 53254**
 36"L x .5"W x .6"H
- Creates valance to conceal tape
 - Irregular surfaces installation
 - Includes screws for installation

6-Pin Male/Male Adapter



- 53342**
 .5"L x .5"W x .25"H
- Changes female end to male
 - Package of 6

Adjustable 6-Pin Connector



- 53462**
 1.18"W x .25"H x 2.3"L
- Used for irregular turns on a flat surface
 - Adjusts from 90° to 180°
 - Great for radius turn alcoves

Drivers

(See page 51-52 for detailed driver information)

53324	24V 30W Class II Driver	53330	24V 100W Dimmable Driver
53326	24V 30W Dimmable Driver	53331	24V 100W Dimmable Driver 277V
53313	24V 60W Plug-In Driver	53287	24V 150W Driver
53318	24V 60W Class II Driver	53288	24V 320W Driver
53286	24V 96W Class II Driver	53289	24V 480W Driver

Plastic Wire Clip



- 53255**
 1"L x .5"W x .25"H
- Secures to surface connecting cords and input/output cords of drivers and controllers
 - Backed with 3M adhesive
 - Package of 10

6-Pin Rough-In Terminal Block



- 53258**
 4"L x .75"W x .5"H
- Rough in for new installation construction between Solar Star 24, 24V Driver or 24V Dimming Controller
 - Female connector on one end with two wire quick connector on opposite end
 - Includes one 6-Pin Male/Male Adapter and installation screw

6-Pin Mounting Clip



- 53273**
 .5"W x .25"H x .5"L
- Use on irregular surfaces when adhesive backing is not sufficient
 - Recommended interval is every 12"
 - Package of 20

6-Pin Silicone End Cap

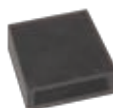

- 53469**
 .75"L x .5"W x .1"H
- Placed on run termination
 - Protects against dust and damage
 - Package of 10

Heat Shrink Wrap



- 53256**
 3"L x 1"W x .25"H
- Secures connections when in walls
 - Waterproof for damp locations
 - Heat gun required for installation
 - Package of 10

6-Pin Male End Cap



- 53344**
 .5"L x .5"W x .25"H
- Placed on female end of run termination
 - Protects against dust and damage
 - Package of 6

STARSTRAND® Color Flex Star 24

Features

- 2900K-5000K color temperature
- Adjustable color temperature from 2900K to 5000K, in conjunction with 53398
- CRI 70-75
- 120° beam spread
- Non-dimmable
- 30,000 rated life hours
- Silicone covered to reduce static failure
- Multiples lengths with soldered connectors for trouble free installation
- Suitable for damp locations
- Highly flexible material that is backed with 3M tape easy installation

Applications

- Cove and toe kick accent lighting
- Outdoor covered porch and patio
- Under cabinet lighting
- Display case
- Restaurants and lounges
- Bathroom lighting

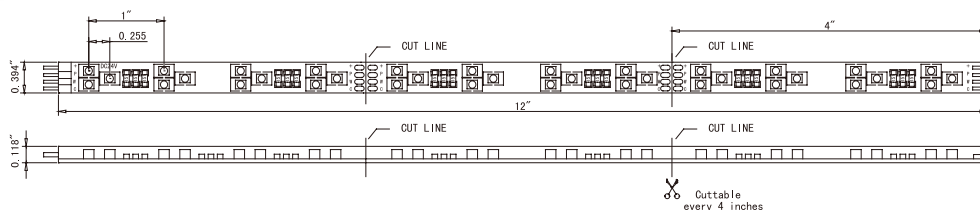

- 53550-COLF-24V-50K-4
- 53551-COLF-24V-50K-12
- 53552-COLF-24V-50K-60
- 53553-COLF-24V-50K-120
- 53554-COLF-24V-50K-240

Item	Length	Diodes	Wattage	Lumens	Color Temp	CRI	PC Board	Beam	Voltage	Current
53550	4"	6	0.96	15-16.5	2900-5000K	70-75	White	120°	24V	40mA
53551	12"	18	2.88	45-50	2900-5000K	70-75	White	120°	24V	120mA
53552	60"	90	14.4	225-250	2900-5000K	70-75	White	120°	24V	600mA
53553	120"	180	28.8	450-500	2900-5000K	70-75	White	120°	24V	1.2A
53554	240"	360	57.6	900-1000	2900-5000K	70-75	White	120°	24V	2.4A

Model Number	Wattage	Maximum Run	Wiring Diagram	Drivers
53324	30W	10'	6	53324 24V 30W Class II Driver
53313, 53318	60W	20'	6	53313 24V 60W Plug-In Driver 53318 24V 60W Class II Driver

Wiring Diagram on page 56

(See page 51-52 for detailed driver information)

4-Pin Mounting Clip



- 53272** .5"W x .25"H x .5"L
- Use on irregular surfaces when adhesive backing is not sufficient
 - Recommended interval is every 12"
 - Package of 20

24V Color Flex Controller



- 53398** 4"L x 4"W x 2"H
- Required to control up to 20' of Color Flex Star 24
 - RF remote control and wall controller are included
 - Adjusts color temperature from 2900K to 5500K
 - 4" 6-Pin power input cord, 72" 4-Pin signal output cord

Heat Shrink Wrap



- 53256** 3"L x 1"W x .25"H
- Secures connections when in walls
 - Waterproof for damp locations
 - Heat gun required for installation
 - Package of 10

6-Pin 4-Way Connector



- 53350** 1.5"L x 1.5"W x .25"H
- Creates a power block for branching between 24V Driver and 24V Color Flex Controller or 24V Amplifier
 - Includes two 6-Pin Male End Caps and one 6-Pin Male/Male Adapter and one Male Extender

45° Angle Mounting Channel



- 53374** 48"L x 1"W x .75"H
- Surface mount to angle tape for accent lighting
 - Aluminum screws included

6-Pin Rough-In Terminal Block



- 53258** 4"L x .75"W x .5"H
- Rough in for new installation construction between 24V Driver and 24V Color Flex Controller or 24V Amplifier
 - Female connector on one end with two wire quick connector on opposite end
 - Includes one 6-Pin Male/Male Adapter and installation screw

4-Pin 4-Way Connector

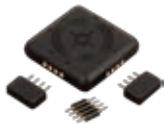

- 53263** 1.5"L x 1.5"W x .25"H
- Allows for L, T, and X installations between 24V Color Flex Controller or 24V Amplifier and Color Flex Star 24
 - Includes two 4-Pin Male End Caps and one 4-Pin Male/Male Adapter

4-Pin Silicone End Cap

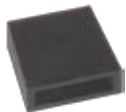

- 53269** .75"L x .5"W x .1"H
- Placed on run termination
 - Protects against dust and damage
 - Package of 10

4-Pin Male End Cap



- 53264** .5"L x .5"W x .25"H
- Placed on female end of run termination
 - Protects against dust and damage
 - Package of 10

6-Pin Connecting Cords



- 53465** 5"L x .75"W x .25"H
53467 13"L x .75"W x .25"H
53468 73"L x .75"W x .25"H
- Extends distance between 24V Driver and 24V Color Flex Controller or 24V Amplifier

24V Amplifier



- 53386** 4"L x 2.5"W x .8"H
- Synchronizes additional runs up to 20' of Color Flex Star 24 to one 24V Color Flex Controller
 - Maximum 27 amplifiers per controller
 - Requires an additional 24V Driver
 - 6" 6-Pin power input cord, 6" 4-Pin signal input cord, 6" 4-Pin signal output cord

Flexible Aluminum Channel



- 53254** 36"L x .5"W x .6"H
- Creates valance to conceal tape
 - Irregular surfaces installation
 - Includes screws for installation

Plastic Wire Clip



- 53255** 1"L x .5"W x .25"H
- Secures to surface connecting cords and input/output cords of drivers and controllers
 - Backed with 3M adhesive
 - Package of 10

Aluminum Channel



- 53373** 60"L x .75"W x .75"H
- Can be recessed or surface mounted
 - Aluminum screws included

4-Pin Rough-In Terminal Block



- 53383** 4"L x .75"W x .5"H
- Rough in for new installation construction between 24V Color Flex Controller or 24V Amplifier and Color Flex Star 24
 - Female connector on one end with four wire quick connector on opposite end
 - Includes one 4-Pin Male/Male Adapter and installation screw

4-Pin Connecting Cords



- 53265** 3"L x .5"W x .25"H
53266 7"L x .5"W x .25"H
53267 13"L x .5"W x .25"H
53268 73"L x .5"W x .25"H
- Extends distance between 24V Color Flex Controller or 24V Amplifier and Color Flex Star 24
 - Connect sections of Color Flex Star 24 together

4-Pin Male/Male Adapter

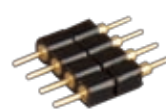

- 53262** .5"L x .5"W x .25"H
- Changes female end of Color Flex Star 24 to male end
 - Package of 10

STARSTRAND® Rainbow Star 24

Features

- Thousands of colors on one tape
- 120° beam spread
- Non-dimmable
- 30,000 rated life hours
- Long run up to 30'
- DMX interface with optional controller
- Silicone covered to reduce static failure
- ETL approved for damp locations
- Multiple lengths with soldered connectors for trouble free installation
- Field cuttable every 4"

Applications

- Cove and toe kick accent lighting
- Restaurants, bars, and lounges
- Store front displays
- Back lighting of glass and acrylic panels
- Game and theatre rooms
- Discos and clubs

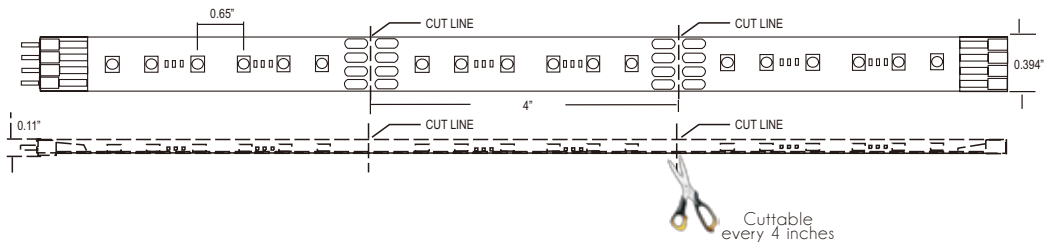
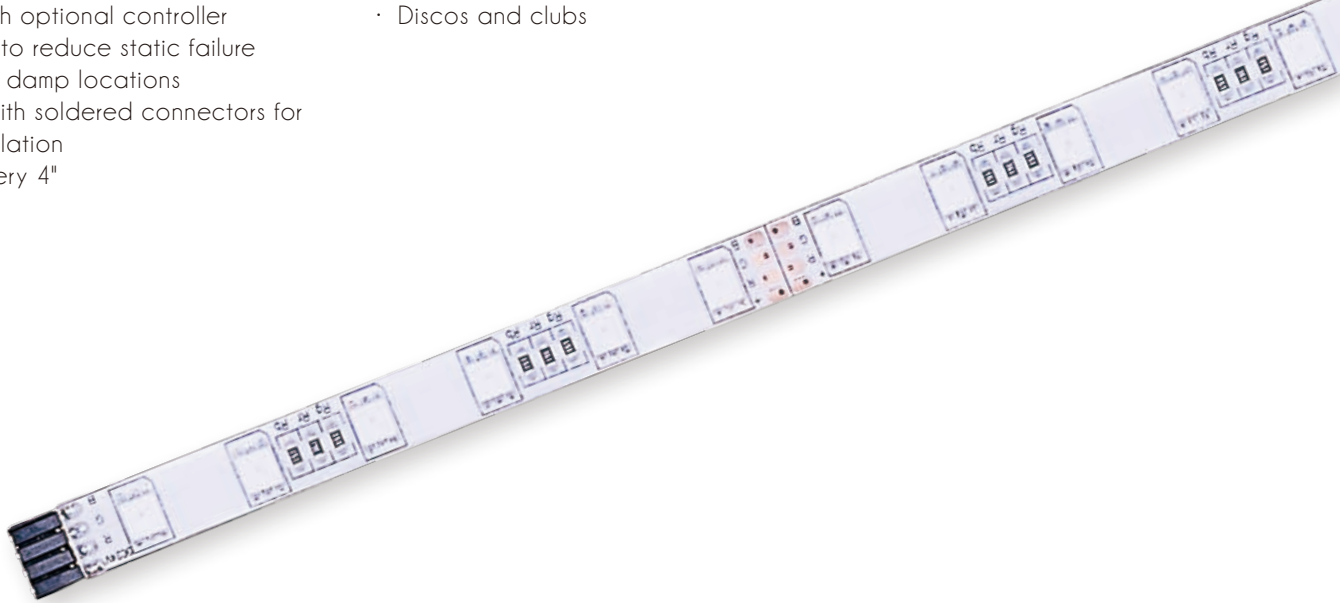

- 53530-RAIS-24V-4
- 53531-RAIS-24V-12
- 53533-RAIS-24V-60
- 53534-RAIS-24V-120
- 53535-RAIS-24V-240

Item	Length	Diodes	Wattage	Lumens	PC Board	Beam	Voltage	Current
53530	4"	6	1.44	R:18 G:30 B:9	White	120°	24V	60mA
53531	12"	18	4.32	R:54 G:90 B:27	White	120°	24V	180mA
53533	60"	90	21.6	R:270 G:450 B:135	White	120°	24V	900mA
53534	120"	180	43.2	R:540 G:900 B:270	White	120°	24V	1.8A
53535	240"	360	86.4	R:1080 G:1800 B:540	White	120°	24V	3.6A

Model Number	Wattage	Maximum Run	Wiring Diagram	Drivers
53324	30 Watts	6'	3	53324 24V 30W Class II Driver
53313, 53318	60 Watts	13'	3	53313 24V 60W Plug-In Driver
53286	96 Watts	22'	3	53318 24V 60W Class II Driver
53287	150 Watts	30'	3	53286 24V 96W Class II Driver
				53287 24V 150W Driver

Wiring Diagram on page 56

(See page 51-52 for detailed driver information)

24V RGB Controller



- 53385** 2.5"W x .75"H x 6"L
- Controls up to 30' of Rainbow Star 24 using included RF remote control
 - 4" 6-Pin power input cord and 72" 4-Pin signal output cord

24V DMX512 Interface/Decoder & Standalone RGB Controller



- 53387** 4.5"W x 1.5"H x 7.5"L
- Controls up to 30' of Rainbow Star 24 using included RF remote control
 - Meets DMX512 protocol and can be used as a DMX decoder
 - 4" 6-Pin power input cord and 72" 4-Pin signal output cord

24V Amplifier



- 53386** 2.5"W x .8"H x 4"L
- Synchronizes additional runs up to 30' of Rainbow Star 24 to one 24V RGB Controller
 - Requires an additional 24V Driver
 - 6" 6-Pin power input cord, 6" 4-Pin signal input cord, 6" 4-Pin signal output cord
 - Maximum 27 amplifiers per controller

4-Pin Silicone End Cap

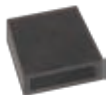

- 53269** .5"W x .1"H x .75"L
- Placed on run termination
 - Protects against dust and damage
 - Package of 10

4-Pin Male End Cap



- 53264** .5"W x .25"H x .5"L
- Placed on female end of run termination
 - Protects against dust and damage
 - Package of 10

4-Pin 4-Way Connector



- 53263** 1.5"W x .25"H x 1.5"L
- Allows for L, T, and X installations between 24V RGB Controller or 24V Amplifier and Rainbow Star 24
 - Includes two 4-Pin Male End Caps and one 4-Pin Male/Male Adapter

45° Angle Mounting Channel



- 53374** 1"W x .75"H x 48"L
- Surface mounts to angle tape for accent lighting
 - Aluminum screws included

Heat Shrink Wrap



- 53256** 1"W x .25"H x 3"L
- Secures connections when in walls
 - Waterproof for damp locations
 - Heat gun required for installation
 - Package of 10

4-Pin Male/Male Adapter

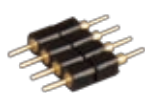

- 53262** .5"W x .25"H x .5"L
- Changes female end of Rainbow Star 24 to male end
 - Package of 10

Plastic Wire Clip



- 53255** .5"W x .25"H x 1"L
- Secures to surface connecting cords and input/output cords of drivers, controllers, and amplifiers
 - Backed with 3M adhesive
 - Package of 10

Rainbow Dial Controller



- 53600** 9"W x 1.8"H
- Controls up to 30' of Rainbow Star 24 using included RF remote control
 - 4" 6-Pin power input cord, 72" 4-Pin signal output cord

4-Pin Rough-In Terminal Block



- 53383** .75"W x .5"H x 4"L
- Rough in for new installation construction between 24V RGB Controller or 24V Amplifier and Rainbow Star 24
 - Female connector on one end with four wire quick connector on opposite end
 - Includes one 4-Pin Male/Male Adapter and stallation screw

6-Pin Rough-In Terminal Block



- 53258** .75"W x .5"H x 4"L
- Rough in for new installation construction between 24V Driver and 24V RGB Controller or 24V Amplifier
 - Female connector on one end with two wire quick connector on opposite end
 - Includes one 6-Pin Male/Male Adapter and installation screw

Flexible Aluminum Channel



- 53254** .5"W x .6"H x 36"L
- Creates valance to conceal tape
 - Irregular surfaces installation
 - Includes screws for installation

4-Pin Mounting Clip



- 53272** .5"W x .25"H x .5"L
- Use on irregular surfaces when adhesive backing is not sufficient
 - Recommended interval is every 12"
 - Package of 20

6-Pin 4-Way Connector



- 53350** 1.5"W x .25"H x 1.5"L
- Creates a power block for branching between 24V Driver and 24V RGB Controller or 24V Amplifier
 - Includes two 6-Pin Male End Caps and one 6-Pin Male/Male Adapter

Aluminum Channel



- 53373** .75"W x .75"H x 60"L
- Can be recessed or surface mounted
 - Aluminum screws included

6-Pin Connecting Cords



- 53465** 5'L x .75"W x .25"H
53467 13"L x .75"W x .25"H
53468 73"L x .75"W x .25"H
- Extends distance between 24V Driver and 24V RGB Controller or 24V Amplifier

4-Pin Connecting Cords



- 53265** 3"L x .5"W x .25"H
53266 7"L x .5"W x .25"H
53267 13"L x .5"W x .25"H
53268 73"L x .5"W x .25"H
- Extends distance between 24V RGB Controller or 24V Amplifier and Rainbow Star 24
 - Connect sections of Rainbow Star 24 together

STARSTRAND® Digital Rainbow Star

Features

- CRI 70-75
- 120° beam spread
- Non-dimmable
- 30,000 rated life hours
- Integral IC chip that allows for individual operation of each diode
- Endless modes can be created, including chasing
- Over 300' of run without additional signal amplifiers
- DMX interface with optional controller
- iPad® / iPhone® interface with optional controller*
- ETL approved for damp locations
- Field cuttable every 4"

* Requires devices be connected to the same wireless network

Download "Digi Star" from your respective iPad, iPhone, iPod touch and Android app store

Applications

- Cove and toe kick accent lighting
- Discos and clubs
- Store front displays
- Recreation rooms
- Game and theater rooms

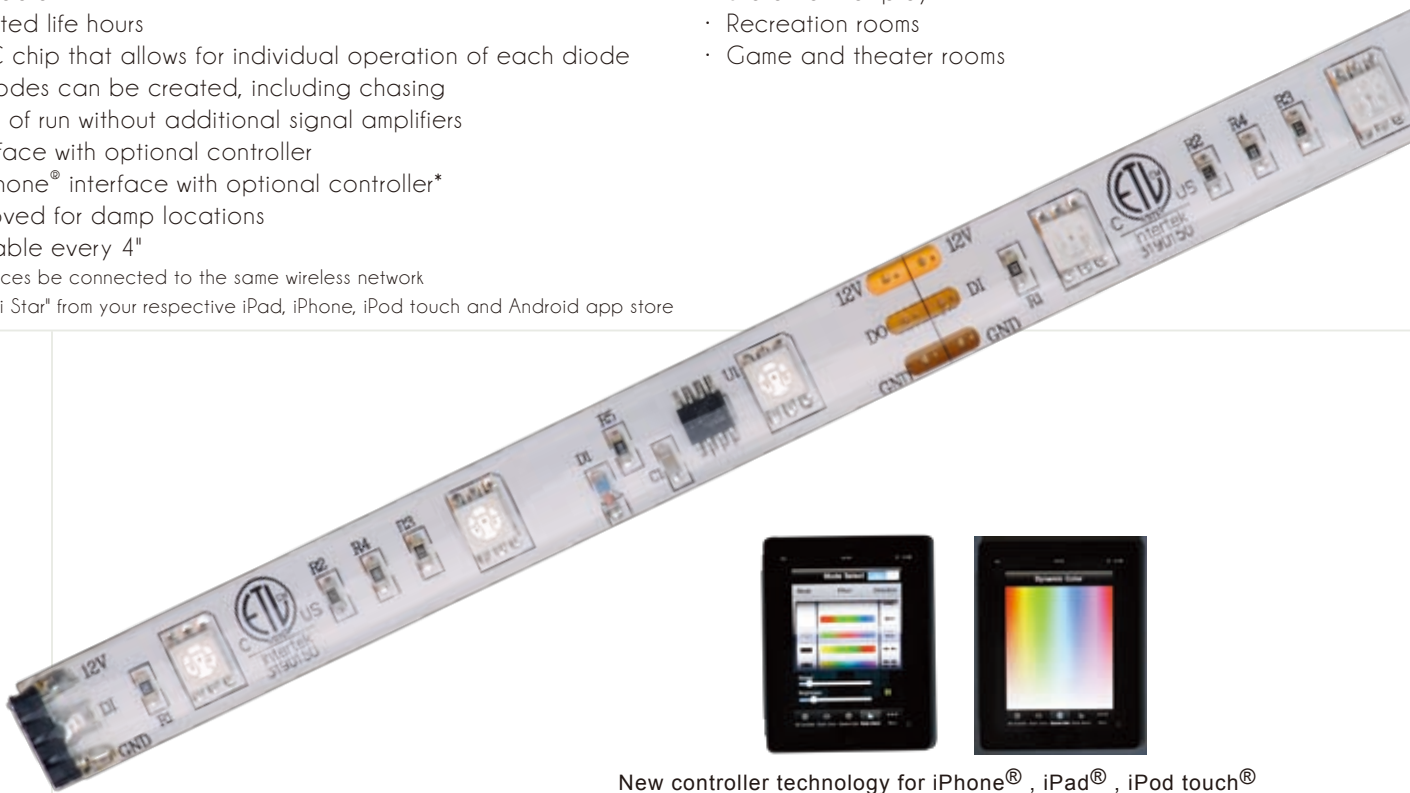

New controller technology for iPhone®, iPad®, iPod touch®
Download "Digi Star" from your respective iPad, iPhone, iPod touch and Android app store

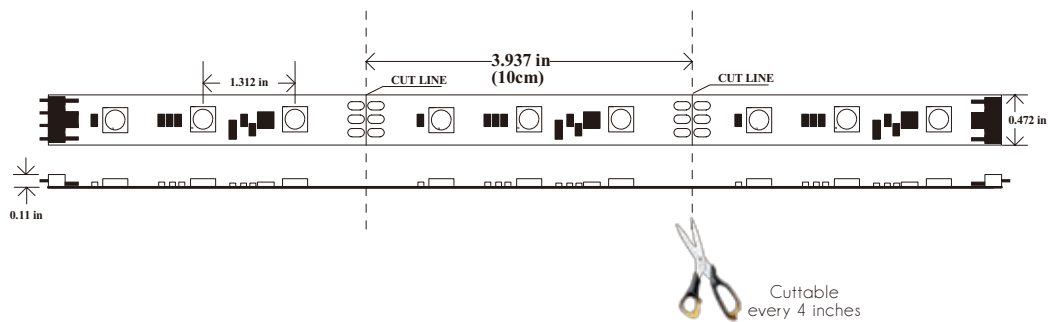

Item	Length	Diodes	Wattage	CRI	PC Board	Beam	Voltage	Current
53560	4"	3	0.32	70-75	White	120°	12V	13.3mA
53561	12"	9	0.96	70-75	White	120°	12V	40mA
53562	60"	45	2.88	70-75	White	120°	12V	120mA
53563	120"	90	14.4	70-75	White	120°	12V	600mA

Model Number	Wattage	Maximum Run	Wiring Diagram
53329	40 Watts	16'	8

Wiring Diagram on page 58

Digital Rainbow Star Controller



- 53391**
2.5"W x 1"H x 4"L
- Controls up to 300' of StarStrand Digital Rainbow Star
 - 36 modes and patterns
 - 20 levels of speed adjustment
 - 16 levels of brightness
 - Power off data memory
 - Remote control included

Digital Rainbow Star DMX Interface/Controller



- 53388**
4.5"W x 1.5"H x 7.5"L
- Controls up to four 300' sections of StarStrand Digital Rainbow Star
 - Four channels of simultaneous output
 - 36 modes and patterns
 - One DMX512 (1990) protocol mode
 - 32 grayscale levels
 - 60 levels of speed adjustment
 - Power off data memory
 - LCD screen shows working status

4-Pin Mounting Clip



- 53272**
.5"W x .25"H x .5"L
- Use on irregular surfaces when adhesive backing is not sufficient
 - Recommended interval is every 12"
 - Package of 20

4-Pin Connecting Cords



- 53265** 3"L x .5"W x .25"H
53266 7"L x .5"W x .25"H
53267 13"L x .5"W x .25"H
53268 73"L x .5"W x .25"H
- Extends distance between Digital Rainbow Star controllers and Digital Rainbow Star
 - Connect sections of Digital Rainbow Star

4-Pin Male End Cap



- 53264**
.5"W x .25"H x .5"L
- Placed on female end of run termination
 - Protects against dust and damage
 - Package of 10

Flexible Aluminum Channel



- 53254**
.5"W x .6"H x 36"L
- Creates valance to conceal tape
 - Irregular surface installations
 - Includes screws for installation

Drivers

(See page 51 for detailed driver information)

53329 12V 40W Class II Driver

Digital Rainbow Star WiFi Controller



- 53392**
2.95"W x 1"H x 4"L
- Uses iPad® / iPhone® / iPod touch® to control system when both device and controller are on the same network
 - Download free app from iTunes
 - IOS user interface for easy operation
 - 347 preset chasing modes
 - 50 user defined custom modes

12V 40w Class II Driver



- 53329**
4"W x 1.5"H x 5.75"L
- Required every 16'
 - Electronic direct wire driver
 - 120V 277V input
 - 12V 3.3A output
 - Short circuit protection
 - Constant voltage
 - IP67 rated
 - Includes wiring compartment
 - Includes 72" 4-Pin output cord
 - Includes one power feed (53566)

Digital Rainbow Star Power Feed



- 53566**
1"W x .15"H x 1"L
- Powers additional StarStrand Digital Rainbow Star tape
 - Required every 16'
 - One included in every driver (53329)
 - Package of 6

4-Pin Rough-In Terminal Block



- 53383**
.75"W x .5"H x 4"L
- Rough-in for new installation construction between Digital Rainbow Star controllers and Digital Rainbow Star
 - Female connector on one end with four wire quick connector on opposite end
 - Includes one 4-Pin Male/Male Adapter and installation screw

4-Pin Silicone End Cap

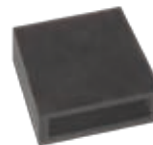

- 53269**
.5"W x .1"H x .75"L
- Placed on run termination
 - Protects against dust and damage
 - Package of 10

Plastic Wire Clip



- 53255**
.5"W x .25"H x 1"L
- Secures to surface connecting cords and input/output cords of drivers, controllers, and amplifiers
 - Backed with 3M adhesive
 - Package of 10

STARSTRAND® Aqua Star 24

Features

- 3500K color temperature
- CRI 70-75
- 120° beam spread
- Magnetic low-voltage dimmer
- 30,000 rated life hours
- High lumen light output
- Long runs up to 50'
- Waterproof IP68 LED tape
- Chemical and UV resistant plastic cover
- Installs into aluminum channel or silicone mounting clips
- Multiple lengths with water light IP68 connectors
- Field cuttable every 4"

*See IP Chart on page 53

Applications

- Swimming pools and fountains
- Outdoor decks
- Step and stairs
- Landscape lighting
- Outdoor building accent lighting
- Driveway and sidewalk illumination

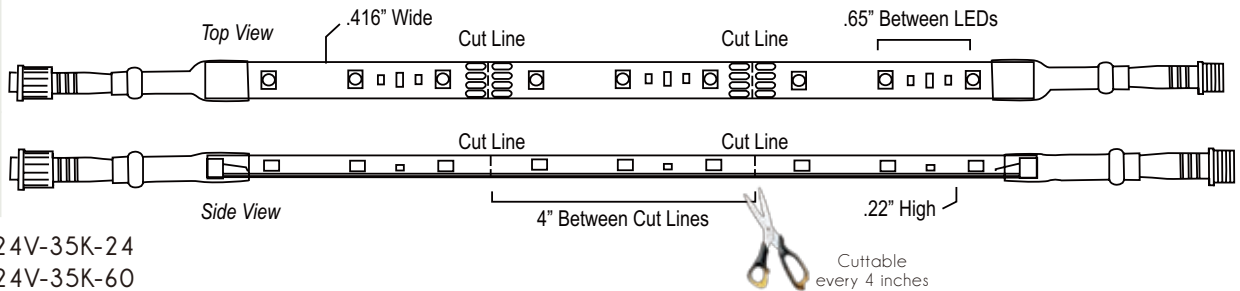

- 53441-AQUA-24V-35K-24
- 53442-AQUA-24V-35K-60
- 53443-AQUA-24V-35K-120
- 53445-AQUA-24V-35K-300

Item	Length	Diodes	Wattage	Lumens	Color Temp	CRI	PC Board	Beam	Voltage	Current
53441	24"	36	5.4	256	3500K	70-75	Black	120°	24V	225mA
53442	60"	90	13.5	640	3500K	70-75	Black	120°	24V	563mA
53443	120"	180	27	1280	3500K	70-75	Black	120°	24V	1.1A
53445	300"	450	67.5	3200	3500K	70-75	Black	120°	24V	2.8A

Model Number	Wattage	Maximum Run	Wiring Diagram
53380	60 Watts	21'	2
53316	100 Watts	30'	2
53381	150 Watts	50'	2

Wiring Diagram on page 56

3500K 120°	
Distance	Foot Candles
12in	29.54
24in	8.42
36in	3.86
48in	2.2

Shown using 1 foot section of Aqua Star 24

24V Outdoor Connecting Cords



- 53364 48"L x .75"W
 53365 144"L x .75"W
- Extend distance between 24V Weatherproof Driver and Aqua Star 24
 - Extend distance between two sections of Aqua Star 24
 - IP68 rated for underwater application up to 10'

Aluminum Channel



- 53373
 60"L x .75"W x .75"
- Can be recessed or surface mounted
 - Aluminum screws included

45° Angle Mounting Channel



- 53374
 48"L x 1"W x .75"
- Surface mount to angle tape for accent lighting
 - Aluminum screws included

Silicone End Cap Kit



- 53368
 .75"L x .5"W x .1"H
- Placed on run termination
 - Protects against water and damage

Mounting Clip



- 53370
 .5"L x .5"W x .25"H
- Use to secure Aqua Star 24 to surface
 - Stainless steel screws included
 - Clear polycarbonate plastic
 - Package of 6

Drivers

(See page 53 for detailed driver information)

- 53380 24V 60W Weatherproof Class II Driver
 53316 24V 100W Weatherproof Class II Dimmable Driver
 53381 24V 150W Weatherproof Class II Driver



STARSTRAND® Rainbow Aqua Star 24

Features

- Waterproof IP68 Color changing LED Tape
- 120° beam spread
- Non-dimmable
- 30,000 rated life hours
- Long run up to 30'
- Nine modes of color and movement
- Chemical and resistant plastic cover
- Installs into aluminum channel or silicone mounting clips
- Multiple lengths with watertight IP68 connectors
- Field cuttable every 4"

Applications

- Swimming pools and fountains
- Outdoor living areas
- Landscape lighting
- Outdoor architectural features
- Signs
- Outdoor walkways

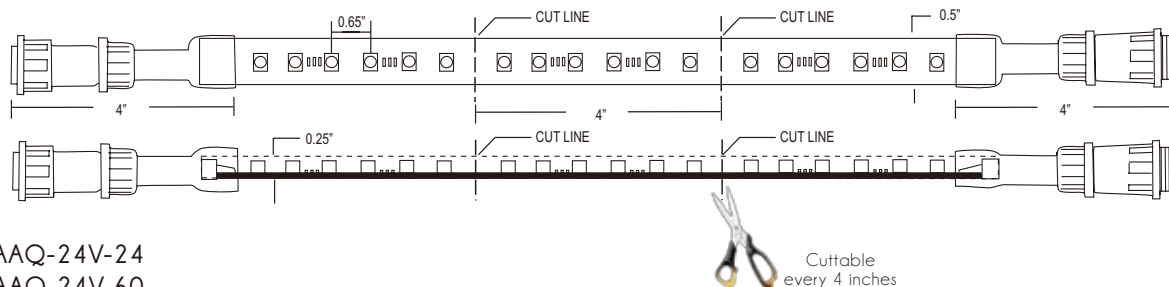
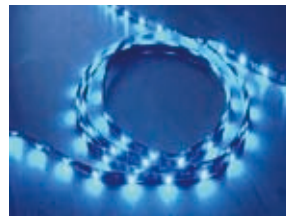

- 53541-RAAQ-24V-24
- 53542-RAAQ-24V-60
- 53543-RAAQ-24V-120
- 53545-RAAQ-24V-300

Cuttable every 4 inches

Item	Length	Diodes	Wattage	Lumens	PC Board	Beam	Voltage	Current
53541	24"	36	8.64	R:108 G:180 B:54	White	120°	24V	360mA
53542	60"	90	21.6	R:270 G:450 B:135	White	120°	24V	900mA
53543	120"	180	43.2	R:540 G:900 B:270	White	120°	24V	1.8A
53545	300"	450	108	R:1350 G:2250 B:675	White	120°	24V	4.5A

Model Number	Wattage	Maximum Run	Wiring Diagram
53380	60 Watts	13'	4
53381	150 Watts	30'	4

Wiring Diagram on page 56

Drivers

(See page 53 for detailed driver information)

- 53380 24V 60W Weatherproof Class II Driver
- 53381 24V 150W Weatherproof Class II Driver

24V Weatherproof RGB Controller



- 53389**
5"L x 2.5"W x 1"H
- Required to control up to 30' of Rainbow Aqua Star 24
 - IP65 rated (not submersible)
 - RF remote control included
 - 4" power input cord, 72" signal output cord

24V Weatherproof Amplifier



- 53390**
4"L x 2.5"W x 1"H
- Synchronizes additional runs up to 30' of Rainbow Aqua Star 24 to one 24V Weatherproof RGB Controller
 - Maximum 27 amplifiers per controller
 - IP65 rated (not submersible)
 - Requires an additional 24V Driver
 - 6" power input cord, 6" signal input cord, 6" signal output cord

24V Outdoor Connecting Cords



- 53364** 48"L x .75"W
53365 144"L x .75"W
- Extend distance between 24V Weatherproof Driver and Rainbow Aqua Star 24
 - Extend distance between two sections of Rainbow Aqua Star 24
 - IP68 rated for underwater application up to 10'

Aluminum Channel



- 53373**
60"L x .75"W x .75"H
- Can be recessed or surface mounted
 - Aluminum screws included

45° Angle Mounting Channel



- 53374**
48"L x 1"W x .75"H
- Surface mount to angle tape for accent lighting
 - Aluminum screws included

Silicone End Cap Kit



- 53368**
.75"L x .5"W x .1"H
- Placed on run termination
 - Protects against water and damage

Mounting Clip



- 53370**
.5"L x .5"W x .25"H
- Use to secure Rainbow Aqua Star 24 to surface
 - Stainless steel screws included
 - Clear polycarbonate plastic
 - Package of 6

STARSTRAND® Channel Star 24

Features

- 3500K or 5000K color temperature
- CRI 70-75
- 120° beam spread
- Magnetic low-voltage dimmer
- 30,000 rated life hours
- High lumen output
- Available in both Bronze and Aluminum finish
- Clear lens for maximum light output
- Ridge aluminum channel conceals light source and provides excellent heat dissipation
- Connect end to end or with the use of connecting cords
- Includes easy to install mounting clips, both downward and 45° angle

Applications

- Under cabinets and bars
- Office desk task lighting
- Retail display cabinets and counters
- Window displays
- Closet lighting



- 53700 AL, BRZ-CHAN-24V-35K-6
- 53701 AL, BRZ-CHAN-24V-35K-12
- 53702 AL, BRZ-CHAN-24V-35K-24
- 53703 AL, BRZ-CHAN-24V-35K-36
- 53704 AL, BRZ-CHAN-24V-35K-48
- 53710 AL, BRZ-CHAN-24V-50K-6
- 53711 AL, BRZ-CHAN-24V-50K-12
- 53712 AL, BRZ-CHAN-24V-50K-24
- 53713 AL, BRZ-CHAN-24V-50K-36
- 53714 AL, BRZ-CHAN-24V-50K-48

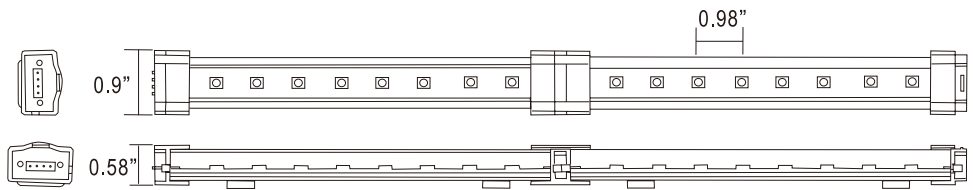

Item	Length	Diodes	Wattage	Lumens	Color Temp	CRI	Beam	Voltage	Current
53700 AL, BRZ	6"	10	1.85	111	3500K	70 - 75	120°	24V	77mA
53701 AL, BRZ	12"	18	3.7	222	3500K	70 - 75	120°	24V	154mA
53702 AL, BRZ	24"	36	7.4	444	3500K	70 - 75	120°	24V	308mA
53703 AL, BRZ	36"	54	11.1	666	3500K	70 - 75	120°	24V	463mA
53704 AL, BRZ	48"	72	14.8	888	3500K	70 - 75	120°	24V	617mA
53710 AL, BRZ	6"	10	1.85	122	5000K	70 - 75	120°	24V	77mA
53711 AL, BRZ	12"	18	3.7	244	5000K	70 - 75	120°	24V	154mA
53712 AL, BRZ	24"	36	7.4	488	5000K	70 - 75	120°	24V	308mA
53713 AL, BRZ	36"	54	11.1	732	5000K	70 - 75	120°	24V	463mA
53714 AL, BRZ	48"	72	14.8	976	5000K	70 - 75	120°	24V	617mA

Model Number	Wattage	Maximum Run	Wiring Diagram
53324, 53326	30 Watts	8'	5
53313, 53318	60 Watts	13'	5
53286	96 Watts	22'	5
53330, 53331	100 Watts	22'	5
53287	150 Watts	32'	5

Wiring Diagram on page 56

3500K 120°	
Distance	Foot Candles
12in	43.77
24in	12.01
36in	5.46
48in	3.16

5000K 120°	
Distance	Foot Candles
12in	63.59
24in	17.96
36in	8.27
48in	4.67

Shown using 1 foot section of Channel Star 24

Shown using 1 foot section of Channel Star 24

6-Pin 4-Way Connector



- 53350**
 1.5"L x 1.5"W x .25"H
- Creates a power block for branching between 24V Driver and 24V Dimming Controller
 - Includes two 6-Pin Male End Caps, one 6-Pin Male/Male Adapter, and one male extender

4-Pin Rough-In Terminal Block



- 53382**
 .75"W x .5"H x 4"L
- Rough in for new installation construction between 24V Driver and Channel Star 24
 - Female connector on one end with four wire quick connector on opposite end
 - Includes one 4-Pin Male/Male Adapter and installation screw

6-Pin Connecting Cords



- 53465** 5"L x .75"W x .25"H
53467 13"L x .75"W x .25"H
53468 73"L x .75"W x .25"H
- Extends distance between 24V Driver, 24V Dimming Controller and Channel Star 24

4-Pin 4-Way Connector



- 53263**
 1.5"L x 1.5"W x .25"H
- Allows for L, T, and X installations between 24V Dimming Controller and Channel Star 24 with connecting cords
 - Includes two 4-Pin Male End Caps and one 4-Pin Male/Male Adapter

4-Pin to 6-Pin Adapter Cord with On/Off Switch



- 53353**
 6"L x 1"W x .5"H
- 6-Pin female to 4-Pin male
 - Used to turn Channel Star 24 on and off when not controlled by a 24V Dimming Controller or by a wall switch

Mounting Clips



- 53354**
 1"L x 1"W x .5"H
- Additional clips for mounting Channel Star 24 to surface
 - Package of 4

Plastic Wire Clip



- 53255**
 1"L x .5"W x .25"H
- Secures to surface connecting cords and input/output cords of drivers, controllers, and amplifiers
 - Backed with 3M adhesive
 - Package of 10

6-Pin Rough-In Terminal Block



- 53258**
 4"L x .75"W x .5"H
- Rough in for new installation construction between 24V Driver and 24V Dimming Controller
 - Female connector on one end with two wire quick connectors on opposite end
 - Includes one 6-Pin Male/Male Adapter and installation screw

4-Pin Connecting Cords



- 53265** 3"L x .5"W x .25"H
53266 7"L x .5"W x .25"H
53267 13"L x .5"W x .25"H
53268 73"L x .5"W x .25"H
- Connects sections of Channel Star 24

Heat Shrink Wrap



- 53256**
 3"L x 1"W x .25"H
- Secures connections when in walls
 - Waterproof for damp locations
 - Heat gun required for installation
 - Package of 10

4-Pin to 6-Pin Adapter Cord



- 53352**
 6"L x 1"W x .5"H
- 6-Pin female to 4-Pin male
 - Included in every 24", 36" and 48" section of Channel Star 24

45° Angle Mounting Clips



- 53355**
 1"L x 1"W x .75"H
- Additional clips for mounting Channel Star 24 to surface at 45° angle
 - Package of 4

Drivers

(See page 51-52 for detailed driver information)

53324	24V 30W Class II Driver	53286	24V 96W Class II Driver
53326	24V 30W Dimmable Driver	53330	24V 100W Dimmable Driver
53313	24V 60W Plug-In Driver	53331	24V 100W Dimmable Driver 277V
53318	24V 60W Class II Driver	53287	24V 150W Driver

STARSTRAND® Rainbow Channel Star 24

Features

- Thousands of color combinations available
- 120° beam spread
- Non-dimmable
- 30,000 rated life hours
- Available in Aluminum finish only
- Clear lens for maximum light output
- Ridge aluminum channel conceals light source and provides excellent heat dissipation
- Connect end to end or with the use of connecting cords
- Includes easy to install mounting clips, both downward and 45° angle

Applications

- Under cabinets and bars
- Alcove lighting
- Retail display cabinets and counters
- Window displays
- Sign illumination

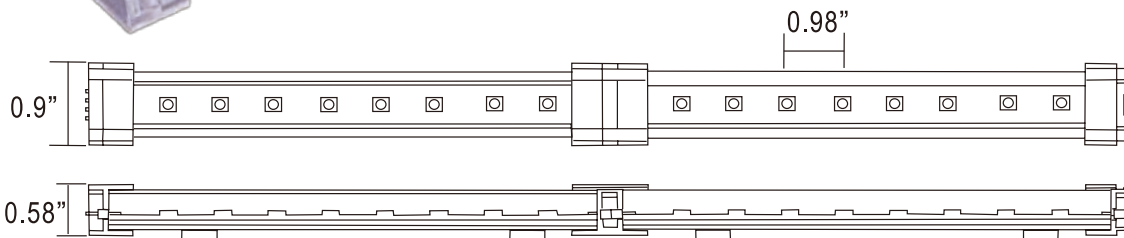
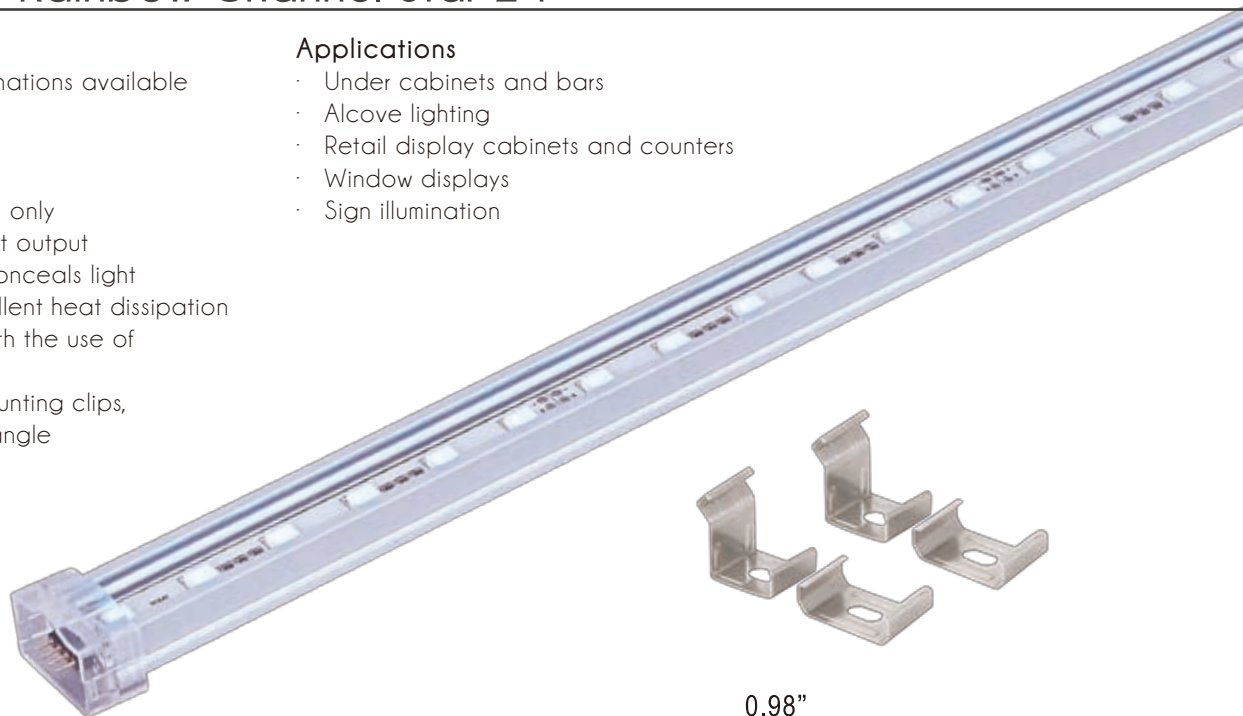

- 53720AL-RAIN-24V-6
- 53721AL-RAIN-24V-12
- 53722AL-RAIN-24V-24
- 53723AL-RAIN-24V-36
- 53724AL-RAIN-24V-48

Item	Length	Diodes	Wattage	Lumens	Beam	Voltage	Current
53720AL	6"	10	2.88	R:30 G:50 B:15	120°	24V	120mA
53721AL	12"	18	4.32	R:54 G:90 B:27	120°	24V	180mA
53722AL	24"	36	8.64	R:108 G:180 B:30	120°	24V	360mA
53723AL	36"	54	12.96	R:162 G:270 B:45	120°	24V	540mA
53724AL	48"	72	17.28	R:216 G:360 B:60	120°	24V	720mA

Model Number	Wattage	Maximum Run	Wiring Diagram
53313, 53318	60 Watts	13'	5
53286	96 Watts	22'	5
53287	150 Watts	30'	5

Wiring Diagram on page 56

Drivers

(See page 52 for detailed driver information)

- 53313 24V 60W Plug-In Driver
- 53318 24V 60W Class II Driver
- 53286 24V 96W Class II Driver
- 53287 24V 150W Driver

STARSTRAND® Rainbow Channel Star 24

24V RGB Controller



- 53385**
4"L x 2.5"W x .8"H
- Controls up to 30' of Rainbow channel Star 24 using included RF remote control
 - 4" 6-Pin power input cord, 72" 4-Pin signal output cord

24V DMX512 Interface/Decoder & Standalone RGB Controller



- 53387**
7.5"L x 4.5"W x 1.5"H
- Controls up to 30' of Rainbow channel Star 24 using included RF remote control
 - Meets DMX512 protocol and can be used as a DMX decoder
 - 4" 6-Pin power input cord and 72" 4-Pin signal output cord

4-Pin Rough-In Terminal Block



- 53383**
4"L x .75"W x .5"H
- Rough in for new installation construction between 24V RGB Controller or 24V Amplifier and Rainbow Channel Star 24
 - Female connector on one end with four wire quick connector on opposite end
 - Includes one 4-Pin Male/Male Adapter and installation screw

6-Pin Connecting Cords



- 53465** 5"L x .75"W x .25"H
53467 13"L x .75"W x .25"H
53468 73"L x .75"W x .25"H
- Extends distance between 24V Driver and 24V RGB Controller or 24V amplifier

4-Pin 4-Way Connector

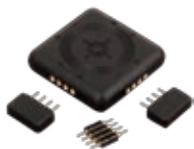

- 53263**
1.5"L x 1.5"W x .25"H
- Allows for L, T, and X installations between 24V RGB Controller or 24V amplifier and Rainbow Channel Star 24 with connecting cords
 - Includes two 4-Pin Male End Caps and one 4-Pin Male/Male Adapter

Mounting Clips



- 53354**
1"L x 1"W x .5"H
- Additional clips for mounting Rainbow Channel Star 24 to surface
 - Package of 4

6-Pin 4-Way Connector



- 53350**
1.5"L x 1.5"W x .25"H
- Creates a power block for branching between 24V Driver, and 24V RGB Controller or 24V amplifier
 - Includes two 6-Pin Male End Caps and one 6-Pin Male/Male Adapter

Rainbow Dial Controller



- 53600**
9"W x 1.8"H
- Controls up to 30' of Rainbow Channel Star 24 using included RF remote control
 - 4" 6-Pin power input cord, 72" 4-Pin signal output cord

24V Amplifier



- 53386**
4"L x 2.5"W x .8"H
- Synchronizes additional runs up to 30' of Rainbow channel Star 24 to one 24V RGB Controller
 - Requires an additional 24V Driver
 - 6" 6-Pin power input cord, 6" 4-pin signal input cord, 6" 4-pin signal output cord
 - Maximum 27 amplifiers per controller

6-Pin Rough-In Terminal Block



- 53258**
4"L x .75"W x .5"H
- Rough in for new installation construction between 24V Driver and 24V RGB Controller or 24V amplifier
 - Female connector on one end with two wire quick connectors on opposite end
 - Includes one 6-Pin Male/Male Adapter and installation screw

Heat Shrink Wrap



- 53256**
3"L x 1"W x .25"H
- Secures connections when in walls
 - Waterproof for damp locations
 - Heat gun required for installation
 - Package of 10

4-Pin Connecting Cords



- 53265** 3"L x .5"W x .25"H
53266 7"L x .5"W x .25"H
53267 13"L x .5"W x .25"H
53268 73"L x .5"W x .25"H
- Extends distance between 24V RGB controller or 24V amplifier and Rainbow Channel Star 24
 - Connect sections of Rainbow Channel Star 24 together

45° Angle Mounting Clips



- 53355**
1"L x 1"W x .75"H
- Additional clips for mounting Rainbow Channel Star 24 to surface at 45° angle
 - Package of 4

Plastic Wire Clip



- 53255**
1"L x .5"W x .25"H
- Secures to surface connecting cords and input/output cords of drivers, controllers, and amplifiers
 - Backed with 3M adhesive
 - Package of 10

STARSTRAND® Rainbow Dial RGB Controller System

StarStrand Rainbow Dial is a new, user friendly way to control Rainbow Star 24 or Rainbow Channel Star 24. With this system, you simply use the remote to dial the color to display. The color is displayed in the center of the dial, allowing the user to not have to be located in the view of the tape. The Rainbow Dial controller has 16 prepositioned changing patterns that are touch controlled. The remote can be wall mounted, with the included bracket, and is powered with an included rechargeable battery.

Features

- 16 color patterns
- Dimmable while on static colors
- Pause functions while doing skipping or gradual change
- 50 levels for brightness adjustment
- 50 levels for speed adjustment

Color Patterns

1. Static Red
2. Static Green
3. Static Blue
4. Static Yellow
5. Static Purple
6. Static Cyan
7. Static White
8. Colors Quickly Change
9. Red Fades
10. Green Fades
11. Blue Fades
12. Yellow Fades
13. Purple Fades
14. Cyan Fades
15. White Fades
16. Colors Gradually Change



Rainbow Dial Controller System 53600

9"W x 1.8"H

Includes:

- Rainbow Dial touch remote control
- Wall mount bracket
- Battery charger
- Rainbow Dial controller



Additional Rainbow Dial controller

53601

9"W x 1.8"H



**30" LED Tape Kit
53480**

Includes 30" tape and plug-in driver with switch

- 2700K color temperature
- 270 Lumens
- Non-dimmable
- 50,000 rated life hours
- Covered with plastic for protection
- Field cut every 2"
- 12V .5 Amp Driver
- 3M adhesive backing



**10' LED Tape Kit
53485**

Includes 120" tape and plug-in driver with switch

- 2700K color temperature
- 1080 Lumens
- Non-dimmable
- 50,000 rated life hours
- Covered with plastic for protection
- Field cut every 2"
- 12V 1.5 Amp Driver
- 3M adhesive backing



**5' LED Tape Kit
53482**

Includes 60" tape and plug-in driver with switch

- 2700K color temperature
- 540 Lumens
- Non-dimmable
- 50,000 rated life hours
- Covered with plastic for protection
- Field cut every 2"
- 12V 1 Amp Driver
- 3M adhesive backing

STARSTRAND® 12V Drivers



12V 30w Class II Driver

53302

5.7"L x 1.9"W x 1.2"H

- Electronic direct wire driver
- 120V-264V input
- 12V, 2.5A output
- Short circuit protection, overload protection, over voltage protection
- Constant current
- Operating temperature: -4°F to 140°F
- IP64 rated
- Includes 72" 4-Pin output cord
- Class II UL1310, UL-RU certified



12V 40w Class II Driver

53329

4"W x 1.5"H x 5.75"L

- Required every 16'
- Electronic direct wire driver
- 120V-277V input
- 12V, 3.3A output
- Short circuit protection
- Constant voltage
- IP67 rated
- Includes wiring compartment
- Includes 72" 4-Pin output cord
- Includes one power feed (53566)

STARSTRAND® Electronic Dimmable Drivers

Exclusive to StarStrand



40 - 100W Dimmable Driver

53330 110V Input

53331 277V Input

9"L x 1.8"W x 1.25"H

- Output Voltage DC24V 4A (100% Load) RMS
- Class 2 constant voltage
- Active PFC function
- Short circuit protection
- Efficiency > 85%
- OVC < 35V
- Minimum load 5 Watt
- Minimum dimmable load 30 Watt
- Wiring compartment w/ 3 x 1/2" KO
- Includes 6-Pin output cord
- Dimmable w/ standard triac dimmer



30W Driver

53324 Non Dimmable 110V - 277V

53326 Dimmable 110V

9.5"L x 2"W x 1.25"H

- Output voltage DC24V 1.25A
- Class 2 constant voltage
- PFC > .95
- Short circuit protection
- Efficiency > 85%
- OVC < 35V
- Minimum load 3 Watt
- Minimum dimmable load 5 Watt
- Wiring compartment w/ 3 x 1/2" KO
- Includes 6-Pin output cord
- Dimmable w/ standard triac dimmer

30W 4-Pin Driver



53323

- 9.5"L x 2"W x 1.25"H
- Output voltage DC24V 1.25A
- Class 2 constant voltage
- PFC > .95
- Short circuit protection
- Efficiency > 85%
- OVC < 35V
- Minimum load 3 Watt
- Minimum dimmable load 5 Watt
- Wiring compartment w/ 3 x 1/2" KO
- Includes 6' output cord
- Dimmable w/ standard triac dimmer

100W 4-Pin Driver



53332

- 9"L x 1.8"W x 1.25"H
- Output voltage DC24V 4A (100% Load) RMS
- Class 2 constant voltage
- Active PFC function
- Short circuit protection
- Efficiency > 85%
- OVC < 35V
- Minimum load 5 Watt
- Minimum dimmable load 30 Watt
- Wiring compartment w/ 3 x 1/2" KO
- Includes 6' output cord
- Dimmable w/ standard triac dimmer

24V 60W Plug-In Driver



53313

- Electronic plug-in driver
- 120V-240V input
- 24V, 2.5A output
- Short circuit protection, overload protection, over voltage protection
- Operating temperature: 32°F to 104°F
- Includes 72" 6-Pin output cord

24V 150W Driver



53287

- 7.75"L x 3.75"W x 1.5"H
- Electronic direct wire driver
- 120V-240V input
- 24V, 6.5A output
- Short circuit protection, overload protection, over voltage protection
- Operating temperature: 14°F to 140°F
- Includes 72" 6-Pin output cord
- UL 1012, UL-RU certified

24V 60W Class II Driver



53318

- 7.1"L x 2.4"W x 1.4"H
- Electronic direct wire driver
- 120V-264V input
- 24V, 2.5A output
- Short circuit protection, overload protection, over voltage protection
- Constant current
- Operating temperature: -4°F to 140°F
- IP64 rated
- Includes 72" 6-Pin output cord
- Class II UL 1310, UL-RU certified

24V 96W Class II Driver



53286

- 8"L x 3.8"W x 1.5"H
- Electronic direct wire driver
- 120V-264V input
- 24V, 4A output
- Short circuit protection, overload protection, over temperature protection, over voltage protection
- Power factor control, constant current
- Operating temperature: -22°F to 122°F
- Includes 72" 6-Pin output cord
- Class II UL 1310, UL-RU certified

24V 480W Driver



53289

- 11"L x 5"W x 1.7"H
- Electronic direct wire driver
- 120V-264V input
- 24V, 20A output
- Short circuit protection, overload protection, over temperature protection, over voltage protection
- Power Factor Control, Constant current
- Operating temperature: -4°F to 140°F
- Includes two 72" 6-Pin output cords
- UL 60950-1, UL-RU certified

24V 320W Driver



53288

- 8.5"L x 4.5"W x 2.25"H
- Electronic direct wire driver
- 120V-240V input
- 24V, 12.5A output
- Short circuit protection, overload protection, over temperature protection, over voltage protection
- Operating temperature: 14°F to 140°F
- Includes two 72" 6-Pin output cords
- UL 60950-1, UL-RU certified

24V 24W Plug-In Driver



53874

- Electronic plug-in driver
- 120V-240V input
- 24V, 1A Output
- Operating temperature 32°F to 104°F
- Includes 60" cord and on-off switch
- Operates up to nine discs

STARSTRAND® 24V Weatherproof Drivers

24V 100W Weatherproof Class I Dimmable Driver



53316

6"L x 2.5"W x 2.25"H

- Magnetic direct wire driver
- 120V input
- 24V, 4A output
- Short circuit protection and overload protection
- Operating temperature: -22°F to 140°F
- Includes 72" weatherproof output cord
- Class II UL 2108, ETL certified
- Requires magnetic low voltage dimmer (not included)

24V 150W Weatherproof Class II Driver



53381

8.75"L x 2.75"W x 1.5"H

- Electronic direct wire driver
- 120V-277V input
- 24V, 6.3A output
- Short circuit protection, overload protection, over temperature protection, over voltage protection
- Power factor control, constant current
- Operating temperature: -22°F to 158°F
- IP67 rated
- Includes 72" weatherproof output cord
- Class II UL 1012, 60950-1, UL-RU certified

24V 60W Weatherproof Class II Driver



53380

7.75"L x 2.5"W x 1.5"H

- Electronic direct wire driver
- 120V-277V input
- 24V, 2.5A output
- Short circuit protection, overload protection, over temperature protection, over voltage protection
- Power factor control, constant current
- Operating temperature: -22°F to 158°F
- IP67 rated
- Includes 72" weatherproof output cord
- Class II UL 879, 8750, 1310, UL-RU certified

IP Chart

IP64	Protected against access to hazardous parts. Dust tight Protected against water splashing from any angle
IP67	Protected against access to hazardous parts. Dust tight Protected against the effects of TEMPORARY submersion in water
IP68	Protected against access to hazardous parts. Dust tight Protected against submersion of up to 5' (1.5 meters)

24V DMX512 Interface/Decoder & Standalone RGB Controller

53387

7.5"L x 4.5"W x 1.5"H

- Meets DMX512 protocol and can be used as DMX interface/decoder
- As a standalone controller, it can control color, color intensity, and speed
- Controls 30' of Rainbow Star 24 or Rainbow Channel Star 24
- RF remote control included
- 4" 6-Pin input cord, 72" 4-Pin output cord, and 12" XLR3 connecting cord
- XLR3 male and female interface to connect multiple units together



Modes - 33

Static red, static green, static blue, static yellow, static purple, static cyan, static white, 7-color jump, 6-color jump, 7-color flick, red/green jump, red/blue jump, green/blue jump, red/green/blue jump, red/green flick, red/blue flick, green/blue flick, red/green/blue flick, red/green/blue smooth, red/green smooth, red/blue smooth, green/blue smooth, red/green/blue gradual, red/green gradual, red/blue gradual, green/blue gradual, red gradual, green gradual, blue gradual, red dim mode, green dim mode, blue dim mode, red/green/blue mix

Remote Functionality

Four button RF remote controls include mode choice, mode set, up and down

Digital Rainbow Star WiFi Controller

53392

2.95"W x 1"H x 4"L

- Uses iPad® / iPhone® / iPod touch® to control system when both device and controller are on the same network
- Download free app from iTunes
- IOS user interface for easy operation
- 347 preset chasing modes
- 50 user defined custom modes



Digital Rainbow Star DMX Interface/Controller

53388

4.5"W x 1.5"H x 7.5"L

- Controls up to four 300' sections of Digital Rainbow Star
- Four channels of simultaneous output
- 36 modes and patterns
- One DMX512 (1990) protocol mode
- 32 grayscale levels
- 60 levels of speed adjustment
- Power off data memory
- LCD screen shows working status



Digital Rainbow Star Controller

53391

2.5"W x 1"H x 4"L

- Controls up to 300' of Digital Rainbow Star
- 36 modes and patterns
- 20 levels of speed adjustment
- 16 levels of brightness
- Power off data memory
- Remote control included



Rainbow Dial Controller



53600

9"W x 1.8"H

- 16 color patterns
- Dimmable while on static colors
- Pause functions while doing skipping or gradual changes
- 50 levels for brightness adjustment
- 50 levels for speed adjustment
- Remote is powered with a rechargeable battery
- Charger and holder are included
- Additional Rainbow Dial RGB Controller available (53601)

Remote Functionality

Multi-Function remote, where the color is displayed in the center of the dial, allowing the user to not have to be located within view of the tape.

Modes - 16

Static red, static green, static blue, static yellow, static purple, static cyan, static white, colors quickly change, red fades, green fades, blue fades, yellow fades, purple fades, cyan fades, white fades, colors gradually change



24V RGB Controller

53385

4"L x 2.5"W x 1"H

- Controls color, color intensity, and speed
- Controls 30' of Rainbow Star 24 or Rainbow Channel Star 24
- RF remote control included
- 4" 6-Pin input cord, 72" 4-Pin output cord

Remote Functionality

Six button RF remote controls include on/off, brightness up/down, speed up/down, mode choice

Modes - 10

Static red, static yellow, static green, static cyan, static blue, static purple, static white, single color rotate, red-green-blue single color jump, colors gradually change in circles



24V Weatherproof RGB Controller

53389

5"L x 2.5"W x 1"H

- Controls color, color intensity, and speed
- Controls 30' of Rainbow Aqua 24
- RF remote control included
- IP65 rated (not submersible)

Remote Functionality

Four button RF remote controls include on/off, speed up/down, mode choice

Modes - 9

Static red, static yellow, static green, static cyan, static blue, static purple, static white, single color jump, colors gradually change



24V Color Flex Controller

53398

4"W x 4"L x 2"H

- Controls up to 20' of Color Flex Star 24 using RF remote control or wall controller, both of which are included
- Adjusts color temperature from 2900K to 5500K
- 4" 6-Pin power input cord, 72" 4-Pin signal output cord

Remote Functionality

Eight button RF remote controls included on/off, color temperature selection, speed up/down, brightness up/down, and pause capability

1. Elite/Solar/Ultima Star 24/Spec Star

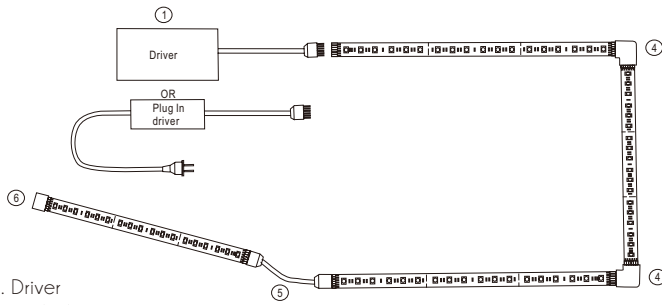

1. Driver
4. 53464 90° connector
5. 53465 5° Connector cord
6. 53469 End Cap

3. Rainbow Star 24

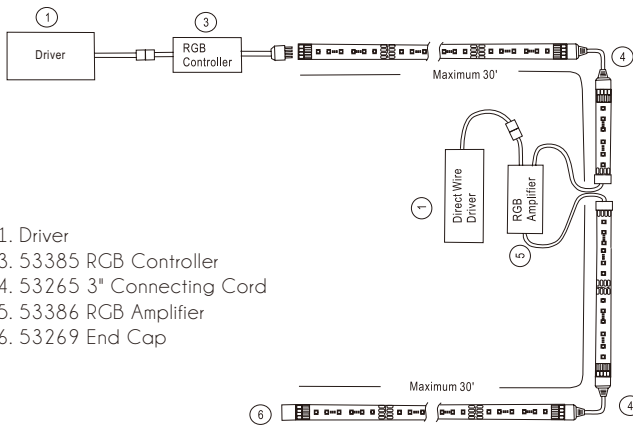

1. Driver
3. 53385 RGB Controller
4. 53265 3° Connecting Cord
5. 53386 RGB Amplifier
6. 53269 End Cap

2. Aqua Star 24

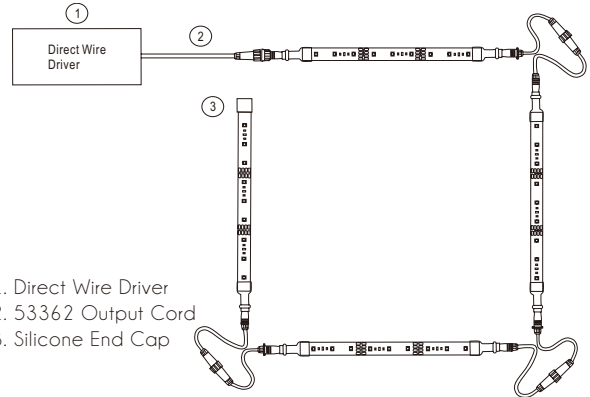

1. Direct Wire Driver
2. 53362 Output Cord
3. Silicone End Cap

4. Rainbow Aqua Star 24

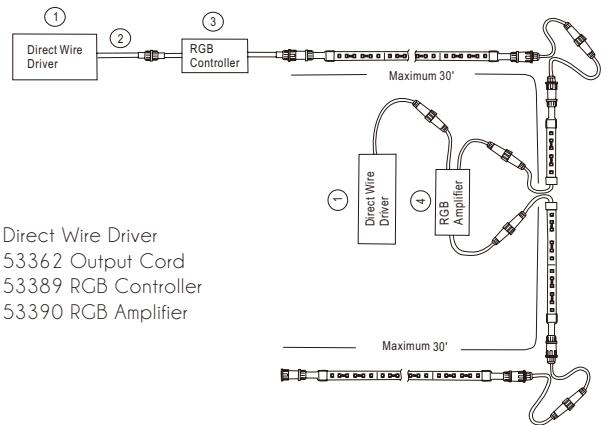

1. Direct Wire Driver
2. 53362 Output Cord
3. 53389 RGB Controller
4. 53390 RGB Amplifier

5. Rainbow Channel/Channel Star 24

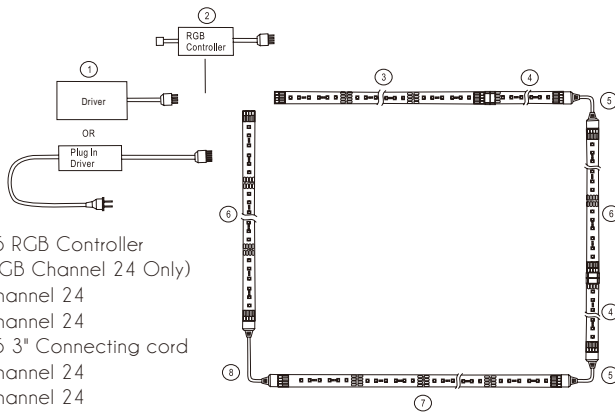

1. Driver
2. 53385 RGB Controller
(For RGB Channel 24 Only)
3. 36" Channel 24
4. 12" Channel 24
5. 53265 3° Connecting cord
6. 24" Channel 24
7. 48" Channel 24
8. 53267 13° Connecting Cord

6. Color Flex Star 24

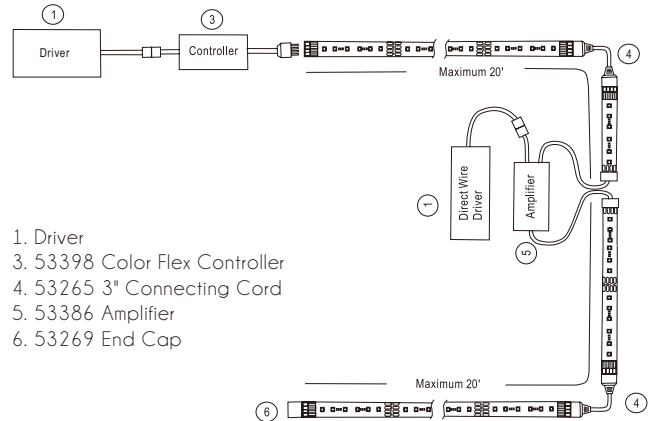

1. Driver
3. 53398 Color Flex Controller
4. 53265 3° Connecting Cord
5. 53386 Amplifier
6. 53269 End Cap

7. Basic Star 24

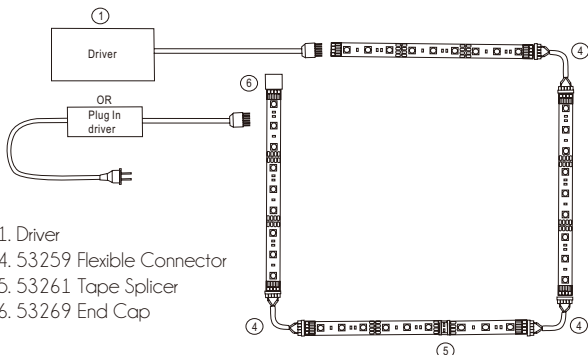

1. Driver
4. 53259 Flexible Connector
5. 53261 Tape Splicer
6. 53269 End Cap

24V Installation and Design Guidelines

- Elite Star 24, Solar Star 24, Ultima Star 24, Aqua Star 24, Rainbow Star 24, Rainbow Aqua Star 24, Color Flex Star 24, and Spec Star, with the exception of the heat sink bar, can be field cut every 4". Once the tape is cut, with the exception of Basic Star 24, you CANNOT add a power connector or rejoin to star section.
- Polarity must be maintained. Each tape has + positive pin. Connectors are marked with + symbol. Positive polarity must be maintained or a section will not light. It is recommended to install all sections and power up to make sure polarity is correct before adhering to surface.
- Use the 4-Way Connectors, Connecting Cords, 90 Degree Connectors, or Adjustable Connectors to get around 90 degree angles, turns, and obstacles. IT IS NOT RECOMMENDED TO BEND TAPE MORE THAN 45 DEGREES.
- 4-Pin 4-Way Connector or 6-Pin 4-Way Connector can also be used to power branched runs up to the maximum. Positioning of the driver is critical to limit the amount of drivers required for each installation.
- Connector Cords can be used between the driver and first tape section, controller/amplifier and first tape section, controller/amplifier and driver, between sections, or to go around corners to extend runs.
- Channels can be used to install on irregular surfaces and also areas where tape will be visible and needs to be concealed.
- End Caps should be used at every termination, whether tape is cut or not.
- 24V RGB Controller is necessary for every Rainbow Star 24 and Rainbow Channel Star 24 installation and is installed after the driver and before the first section of Rainbow Star 24 or Rainbow Channel Star 24 tape. 24V RGB Controller will only work on Rainbow Star 24 or Rainbow Channel Star 24.
- 24V Weatherproof RGB Controller is necessary for every Rainbow Aqua 24 installation and is installed after the driver and before the first section of Rainbow Aqua 24 tape. 24V Weatherproof RGB Controller will only work on StarStrand Rainbow Aqua 24.
- 24V Color Flex Controller is necessary for every Color Flex Star 24 installation and is installed after the driver and before the first section of Color Flex 24, Solar Star 24, and Spec Star tape. 24V Weatherproof RGB Controller will only work on Color Flex Star 24.
- 24V Dimming Controller will work on Elite Star 24, Ultima Star 24, and Channel Star 24. 24V Dimming Controller is installed after the driver and before the first section of tape or channel.
- 24V 96W Direct Wire Driver, 24V 60W Dimmable Direct Wire Driver, 24V 100W Dimmable Direct Wire Driver, 24V 100W Weatherproof Dimmable Direct Wire Driver, 24V 60W Weatherproof Driver, and 24V 150W Weatherproof Driver are Class II drivers.
- 4-Pin Connector Cords, Input Cords, and Output Cords are made from 22 gauge wire. 6-Pin Connector Cords, Input Cords, and Output Cords are made from 20 gauge wire.
- Connector Cords are not CL2/CL3 rated. This means that the Connector Cords are not fire rated for in-wall installations.
- In order to do an in-wall installation for StarStrand, the customer will need to purchase the 4-Pin Rough In Terminal Block, 6-Pin Rough In Terminal Block, or 4-Pin RGB Rough In Terminal Block and place the blocks on each side of CL2/CL3 Rated Low Voltage Wire. A sample installation would be Romex/Line > Driver > Driver Output Cord > Rough In Terminal Block > Wall > CL2/CL3 Rated Low Voltage Wire > Wall > Rough in Terminal Block > Tape. Rough-in Terminal Blocks can handle up to 16 gauge wire.
- If splicing Connector Cords is required, when splicing the 4-Pin Connector Cords, the Red/Blue wire is Negative, the Black/Green wire is positive. When splicing the 6-Pin Connector Cords, the Blue wire is Negative, the Brown wire is Positive.
- The maximum amount of cord (Driver Output Cord, Connector Cords, Controller/Amplifier Input Cord, Controller/Amplifier Output Cord) that can be used in any StarStrand 12V or StarStrand 24V run is 24 total feet before any voltage drop will occur. Connector Cords can also be used to increase the distance between the driver and tape, driver and controller/amplifier, and controller/amplifier and tape; not to exceed 24 total feet.
- StarStrand LED tape can operate in an environment between 14°F and 122°F.
- The Aqua 24 IP68 connectors are roughly .75" thick.
- Use aftermarket industrial grade silicone that meets the requirements of the climate when installing Aqua Star 24 or Rainbow Aqua Star 24.

8. Digital Rainbow Star

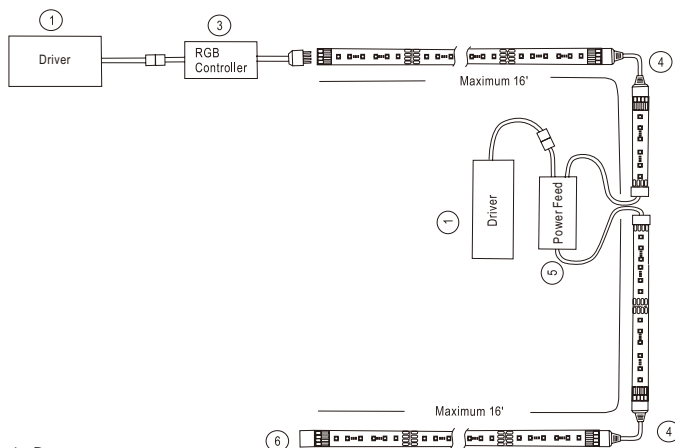

1. Driver
3. 53391 RGB Controller
4. 53265 3' Connecting Cord
5. 53566 Power Feed
6. 53269 End Cap

12V Installation and Design Guidelines

- Digital Rainbow Star can be field cut every 4".
- Polarity must be maintained. Each tape has + positive pin. Connectors are marked with + symbol. Positive polarity must be maintained or a section will not light. It is recommended to install all sections and power up to make sure polarity is correct before adhering to surface.
- Use the 4-Pin 4-Way Connector and 2" sections to get to 90 degree angles and turns. Connector Cords can also be used for corners and around obstacles. IT IS NOT RECOMMENDED TO BEND TAPE MORE THAN 45 DEGREES.
- The 4-Pin 4-Way Connector can also be used to power branched runs up to the maximum. Positioning of the 12V driver is critical to limit the amount of drivers required for each installation. Position 12V driver in middle, or corners, runs to power the 4-Pin 4-Way Connector.
- Connector Cords can be used between the driver and the first tape section, driver and dimming controller, between sections, to go around corners, and to extend runs.
- 36" Universal Aluminum Channel can be used to install on irregular surfaces and also areas where tape will be visible and needs to be concealed.
- 4-Pin Male End Cap and 4-Pin Silicone End Cap should be used at every termination, whether tape is cut or not.
- 12V Dimming Controller will work on Basic Star. 12V Dimming Controller is installed after the driver and before the first section of tape.
- 12V 60W Indoor Plug-In Driver, 12V 60W Direct Wire Driver, 12V 60W Dimmable Direct Wire Driver are Class II Drivers.
- 4-Pin Connector Cords, Input Cords, and Output Cords are made from 22 gauge wire.
- Connector Cords are not CL2/CL3 rated. This means that the Connector Cords are not fire rated for in-wall installations.
- In order to do an in-wall installation for StarStrand, the customer will need to purchase the 4-Pin Rough In Terminal Block™ and place the blocks on each side of CL2/CL3 Rated Low Voltage Wire. A sample installation would be Romex/Line > Driver > Driver Output Cord > Rough In Terminal Block > Wall > CL2/CL3 Rated Low Voltage Wire > Wall > Rough in Terminal Block > Tape.
- If splicing Connector Cords is required, when splicing, the Red/Blue wire is Negative, the Black/Green wire is Positive.
- The maximum amount of cord (Driver Output Cord, Connector Cords, Dimming Controller Input Cord, Dimming Controller Output Cord) that can be used in any 12V run is 24 total feet before any voltage drop will occur. Connector Cords can also be used to increase the distance between the driver and tape, driver and dimming controller, and dimming controller and tape; not to exceed 24 total feet.
- LED tape can operate in an environment between 14°F and 122°F.

Maximum Run Chart

Series	Driver Wattage	Driver Models	Max Run	Max Run Using 2-Cord Output
Aqua Star 24	60 Watts	53380	21 Feet
	100 Watts	53316	30 Feet
	150 Watts	53381	50 Feet
Basic Star 24	30 Watts	53324, 53326	22 Feet
	60 Watts	53313	32 Feet
Channel Star 24	30 Watts	53324, 53326	8 Feet
	60 Watts	53313, 53318	13 Feet
	96 Watts	53286	22 Feet
	100 Watts	53330, 53331	22 Feet
	150 Watts	53287	32 Feet
Color Flex Star 24	30 Watts	53324	10 Feet
	60 Watts	53313, 53318	20 Feet
Digital Rainbow Star	40 Watts	53329	16 Feet
Elite Star 24	30 Watts	53324, 53326	11 Feet
	60 Watts	53313, 53318	20 Feet
	96 Watts	53286	33 Feet
	100 Watts	53330, 53331	33 Feet
	150 Watts	53287	50 Feet
	320 Watts	53288	75 Feet	105 Feet
	480 Watts	53289	75 Feet	150 Feet
Glow 24	30 Watts	53323	10 Feet
	100 Watts	53332	35 Feet
Rainbow Star 24	30 Watts	53324	6 Feet
	60 Watts	53313, 53318	13 Feet
	96 Watts	53286	22 Feet
	150 Watts	53287	30 Feet

Maximum Run Chart

Series	Driver Wattage	Driver Models	Max Run	Max Run Using 2-Cord Output
Rainbow Aqua Star 24	60 Watts	53380	13 Feet
	150 Watts	53381	30 Feet
Rainbow Channel Star 24	60 Watts	53313, 53318	13 Feet
	96 Watts	53286	22 Feet
	150 Watts	53287	30 Feet
Solar Star 24	30 Watts	53324, 53326	8 Feet
	60 Watts	53313, 55318	13 Feet
	96 Watts	53286	22 Feet
	100 Watts	53330, 53331	22 Feet
	150 Watts	53287	32 Feet
	320 Watts	53288	50 Feet	70 Feet
	480 Watts	53289	50 Feet	100 Feet
Spec Star	30 Watts	53324	6 Feet
	30 Watts	53326	6 Feet
	60 Watts	53313, 53318	12 Feet
	96 Watts	53286	22 Feet
	100 Watts	53330, 53331	22 Feet
Ultima Star 24	30 Watts	53324, 53326	8 Feet
	60 Watts	53313, 55318	13 Feet
	96 Watts	53286	22 Feet
	100 Watts	53330, 53331	22 Feet
	150 Watts	53287	32 Feet
	320 Watts	53288	50 Feet	70 Feet
	480 Watts	53289	50 Feet	100 Feet

DISPLAYS & SELLING CASES



A. CounterMax MX-L Series
DSP022L
24"W x 12"H x 12"L

G. CounterMax Storage Cabinet
DSP025WT
24"W x 30"H x 18"L

C. CounterMax MX-X12 Series
DSP022X12
24"W x 12"H x 12"L

H. CounterMax MX-LD Series
DSP015SV
14"W x 12"H x 6"L

M. StarStrand Channel Star 24**
DSP014SV
14"W x 12"H x 6"L

D. CounterMax MX-X120 Series
DSP022X120
24"W x 12"H x 12"L

I. CounterMax MX-L120-LO & MX-L120-EL Series
DSP032WT
24"W x 12"H x 12"L

N. CounterMax MX-L-LPC Series
DSP022LLPC
24"W x 12"H x 12"L

E. CounterMax MX-FD Series
DSP022FD
24"W x 12"H x 12"L

J. StarStrand LED Tape*
DSP018SV
14"W x 12"H x 6"L

O. LED CounterMax Display***
DSP027LED
24"W x 12"H x 12"L

F. CounterMax Display Riser
DSP024WT
24"W x 6"H x 9"L

L. CounterMax/StarStrand Selling Case 24W
DSP019AL
16.5"W x 4.75"H x 12.5"L

P. LED Display
DSP030LED
24"W x 12"H x 12"L

*Includes Basic Star, Ultima Star 24, Elite Star 24, Solar Star 24, Color Flex Star 24, Rainbow Star 24, Aqua Star 24 and Rainbow Aqua Star 24.

**Includes Channel Star 24 3000 K, Channel Star 24 5000 K and Rainbow Channel Star 24.

***Includes CounterMax MX-L-LPC, MX-LD-D, MX-L120DL.

Features

- 3000K color temperature
- Not recommended for 24/7 applications
- Suitable for Wet Locations



This very compact LED flush mount easily installs on any 3.25" octagon box and gives the look of a recessed trim. Constructed of die cast aluminum, this diverse luminaire is dimmable and also approved for wet location, so it can be used in virtually any ceiling application, including showers.



87610WTWT



87610WTSN



87610WTBZ

87610 WTBZ, WTSN, WTWT
LED Flush Mount
6.5"W x 1.75"H
10W LED (Included)
1000 Initial Lumens
700 Delivered Lumens



CONVERT COLLECTION

Now you can convert a standard 3" outlet box to a low profile LED recessed fixture. Convert's patent pending design allows for the driver to install into an electrical box, which requires no fire rated cover. This creates a fixture with only a 1" extension from the ceiling. High efficiency and smooth dimming down to 5% makes this an excellent choice for hallways, kitchens, and utility lighting.



Features

- 2800K or 4000K color temperature
- CRI 80
- Beam spread 110°
- Dimmable to 5%
- 110V Input Voltage
- Power Factor 90+
- THD less than 10%
- Suitable for damp location



87615WTBZ



87615WTWT
87617WTWT
87620WTWT



87615WTSN
87620WTSN

87620 WTSN, WTWT
LED Flush Mount
8"W x 1.1"H
20W LED (Included)
1400 Lumens
2800/2900K Color Temperature



87617WTWT
LED Flush Mount
White
8"W x 1.1"H
15W LED (Included)
1100 Lumens
4000K Color Temperature



87615 WTBZ, WTSN, WTWT
LED Flush Mount
8"W x 1.1"H
15W LED (Included)
1050 Lumens
2800/2900K Color Temperature



New Construction

- Mounts to 3 1/4" and 4" J-Box with a minimum depth of 2.25"
- Converts standard electrical box to a recessed styled fixture
- 1" extension
- Cast Aluminum heat sink provides long LED diode life
- Commercial and Residential application
- High powered dimmable LED
- Cost effective solution for Fire Rated Downlighting applications, as there is no need for fire rated covers

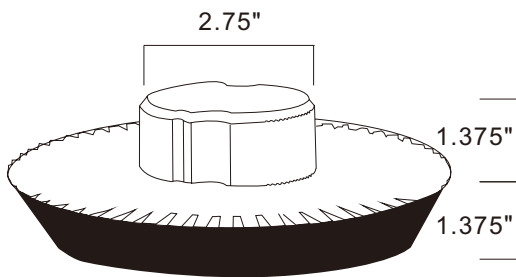

Installs into 3 1/4" and 4" electrical box, with a minimum 2.5" depth

Recommended Dimmers:
The Convert is designed to dim with a standard Triac forward phase dimmer. Dimming levels will vary by dimmer.

- Lutron MACL-153M
- Lutron DVL-153P
- Lutron SCL-153P
- Leviton IPL06-10Z
- Leviton 6674-POW

Due to the inrush, current wattage should not exceed 150 Watts of product for a 600 Watt dimmer.

Model: 87615 / 87617

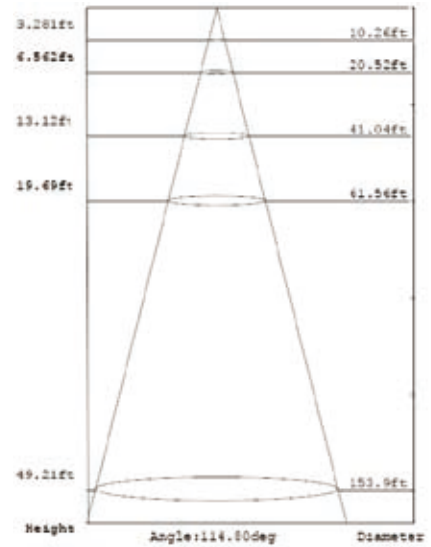

Model: 87620

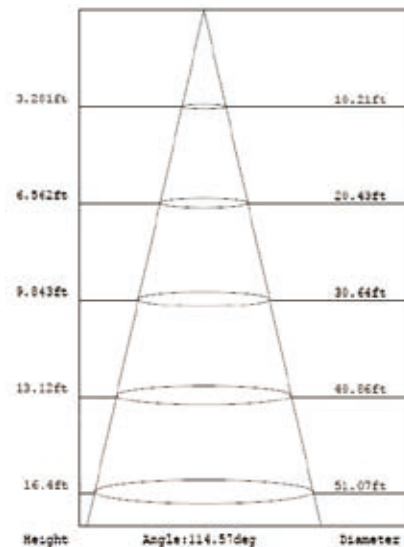

Photometric Test Report

Model: 87615 / 87617

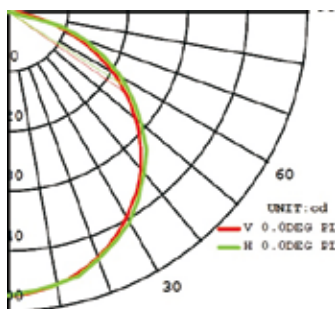

Model: 87620

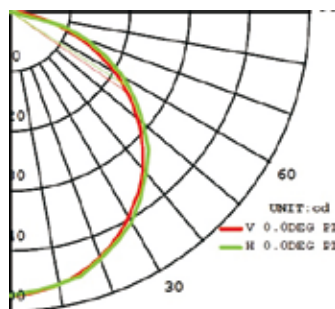

INDEX

53204.....	23	53341.....	28,30,32,34	53465.....	28
53206.....	25	53342.....	28,30,32,34	30,32,34,36,38,46,48	
53207.....	25	53344.....	28,30,32,34	53467.....	28
53254.....	24	53350.....	28	30,32,34,36,38,46,48	
26,30,32,34,36,38,40		30,32,34,36,38,46,48		53468.....	28
53255.....	5,6,7,8	53352.....	46	30,32,34,36,38,46,48	
9,10,12,13,18,24,26,28		53353.....	46	53469.....	28,30,32,34
30,32,34,36,38,40,46,48		53354.....	46,48	53470.....	33
53256.....	24,26,	53355.....	46,48	53471.....	33
28,30,32,34,36,38,46,48		53364.....	42,44	53472.....	33
53257.....	24,26	53365.....	42,44	53473.....	33
53258.....	28	53368.....	42,44	53474.....	33
30,32,34,36,38,46,48		53370.....	42,44	53480.....	50
53259.....	24	53373.....	24,36,38,42,44	53482.....	50
53260.....	24	53374.....	24,26,36,38,42,44	53485.....	50
53261.....	24	53380.....	53	53530.....	37
53262.....	24,26,36,38	53381.....	53	53531.....	37
53263.....	24,26,36,38,46,48	53382.....	46	53533.....	37
53264.....	26,36,38,40	53383.....	36,38,40,48	53534.....	37
53265.....	24	53385.....	38,48,55	53535.....	37
26,36,38,40,46,48		53386.....	36,38,48	53541.....	43
53266.....	24	53387.....	38,48,54	53542.....	43
26,36,38,40,46,48		53388.....	40,54	53543.....	43
53267.....	24	53389.....	44,55	53545.....	43
26,36,38,40,46,48		53390.....	44	53550.....	35
53268.....	24	53391.....	40,54	53551.....	35
26,36,38,40,46,48		53392.....	40,54	53552.....	35
53269.....	24,26,36,38,40	53398.....	36,55	53553.....	35
53272.....	26,36,38,40	53430.....	31	53554.....	35
53273.....	28,30,32,34	53431.....	31	53560.....	39
53286.....	52	53432.....	31	53561.....	39
53287.....	52	53433.....	31	53562.....	39
53288.....	52	53434.....	31	53563.....	39
53289.....	52	53441.....	41	53566.....	40
53302.....	51	53442.....	41	53570.....	27
53313.....	52	53443.....	41	53571.....	27
53316.....	53	53445.....	41	53572.....	27
53318.....	52	53450.....	29	53574.....	27
53323.....	52	53451.....	29	53575.....	27
53324.....	51	53452.....	29	53577.....	22
53326.....	51	53453.....	29	53581.....	22
53329.....	40,51	53454.....	29	53582.....	22
53330.....	51	53455.....	29	53583.....	22
53331.....	51	53462.....	28,30,32,34	53584.....	22
53332.....	52	53464.....	28,30,32,34	53585.....	22

INDEX

53586.....	22	87840.....	12	89952.....	5,9
53588.....	22	87841.....	12	89953.....	5,9
53590.....	22	87842.....	12	89954.....	5,9
53600.....	38,48,49,55	87843.....	12	89958.....	5,9
53601.....	49	87844.....	12	89962.....	6
53700.....	45	87849.....	13	89963.....	6
53701.....	45	87850.....	12,13	89964.....	6
53702.....	45	87851.....	13	89965.....	6
53703.....	45	87852.....	13	89966.....	6
53704.....	45	87853.....	13	89972.....	8
53710.....	45	87856.....	12,13	89973.....	8
53711.....	45	87857.....	12,13	89974.....	8
53712.....	45	87858.....	12,13	89976.....	8
53713.....	45	87859.....	13	DSP014SV.....	61
53714.....	45	87860.....	12,13	DSP015SV.....	61
53720.....	47	87861.....	13	DSP018SV.....	61
53721.....	47	87862.....	13	DSP019AL.....	61
53722.....	47	87863.....	13	DSP022FD.....	61
53723.....	47	87876.....	6,7,8,10	DSP022L.....	61
53724.....	47	87877.....	6,7,8,10	DSP022LLPC.....	61
53860.....	15	87878.....	6,7,8,10	DSP022X12.....	61
53868.....	16	87880.....	6,7,8,10	DSP022X120.....	61
53869.....	16	87881.....	17	DSP024WT.....	61
53874.....	16,52	87883.....	17	DSP025WT.....	61
53878.....	16	87885.....	6,7,8,10	DSP027LED.....	61
53879.....	16	87892.....	7,8,10	DSP030LED.....	61
87610.....	62	87893.....	7,8,10	DSP032WT.....	61
87615.....	63	87894.....	7,8,10		
87617.....	63	87896.....	7,8,10		
87620.....	63	89901.....	5		
87803.....	18	89902.....	5		
87805.....	14	89903.....	5		
87806.....	14	89904.....	5		
87807.....	14	89922.....	10		
87809.....	14	89923.....	10		
87817.....	18	89924.....	10		
87818.....	18	89926.....	10		
87819.....	18	89932.....	7		
87820.....	18	89933.....	7		
87823.....	18	89934.....	7		
87830.....	11	89936.....	7		
87831.....	11	89941.....	9		
87832.....	11	89942.....	9		
87833.....	11	89943.....	9		
87834.....	11	89951.....	5,9		

LMXCAT1408



MAXIM[®]
L I G H T I N G
maximlighting.com



Maxim Lighting International
253 North Vineland Avenue
City of Industry, CA 91746
USA
Website: maximlighting.com

General Information
Call 626.956.4200
General Fax: 626.956.4235
Customer Service: 800.486.2946

Dallas Trade Mart information
Call 214.748.8455
Showroom: 3901
Email: info@maximlighting.com