

BROX

MODULAR LIGHTING SYSTEM





Express yourself with light. The Brox System frees your creativity with modular light bars, blanks and connectors that can be snapped together to design personalized sculptural motifs or to enhance the architecture of your space with distinctive, contemporary linear accent lighting.

EXPLORE THE ENDLESS POSSIBILITIES WITH BROX

Brox can be designed as a decorative modern chandelier or as an architectural accent. The Brox system allows multi-dimensionality for suspending unique geometric shapes, linear lighting, task lighting, or distinctive light sculpture — a system with endless possibilities.

Customize your design with countless configurations:



Linear Bar



Geometric Pendant

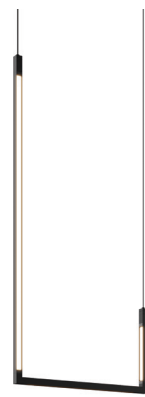

Deconstructed Rectangle



Vertical Pendant



Organic Multi-tiered Pendants

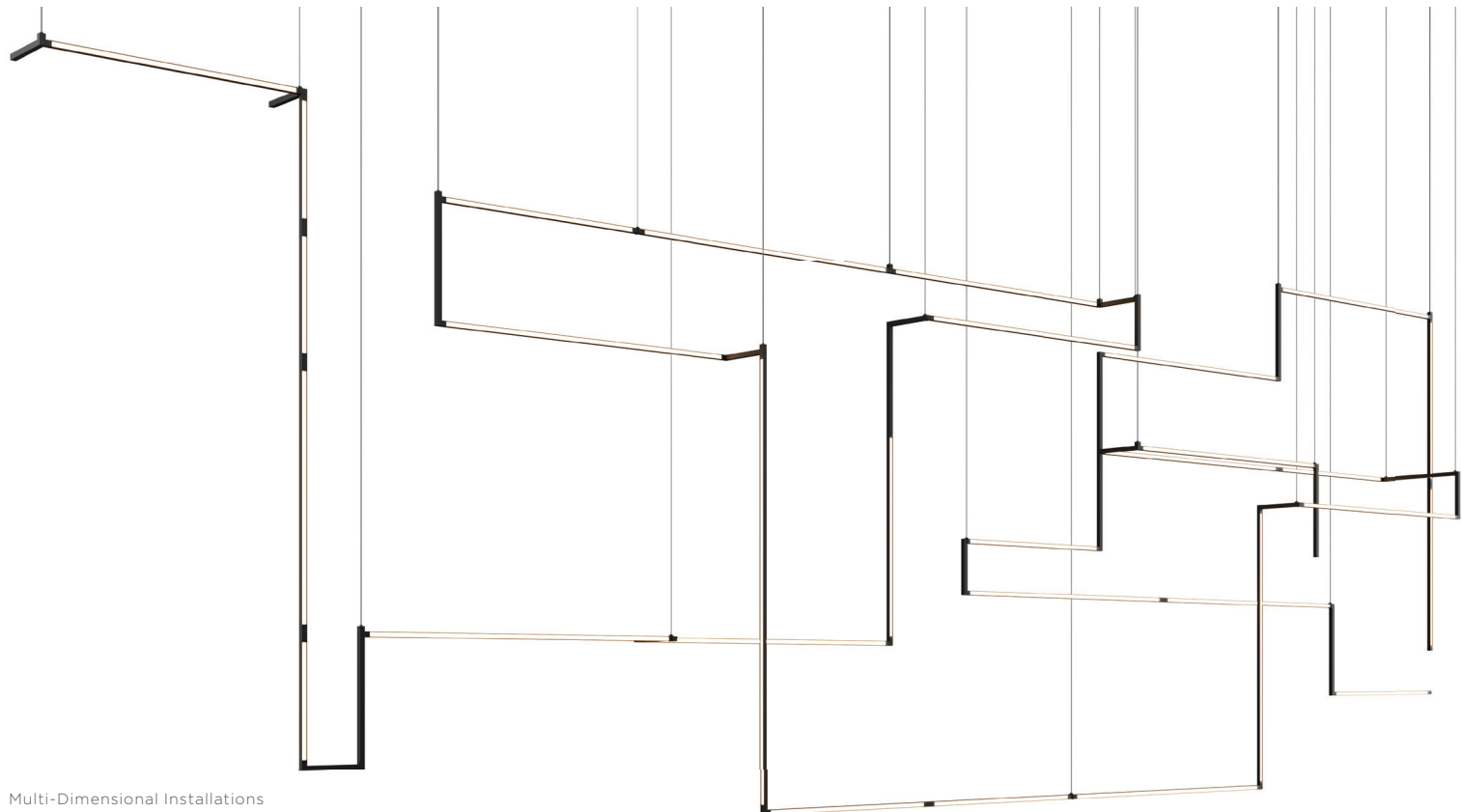

Multi-Dimensional Installations



BROX FEATURES

LIGHT & BLANK BARS

Lengths: 1', 2', 4', 6' and 8'

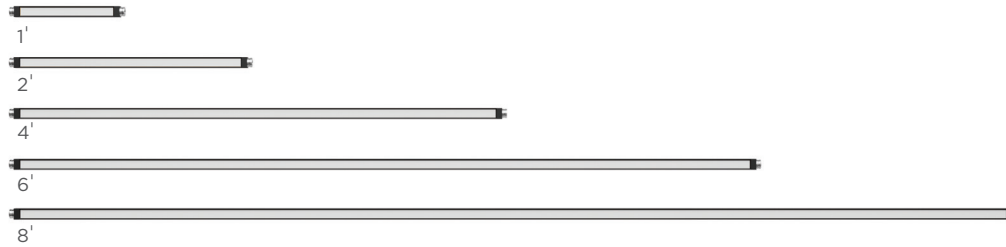

BEVELED EDGE HELPS
REDUCE GLARE AND
CREATES A CLEAN,
MODERN AESTHETIC

ADJUSTABILITY

360° rotating and lockable
LED Light Bars for direct or
indirect illumination



BLANK BARS

Blanks can connect
illuminated sections

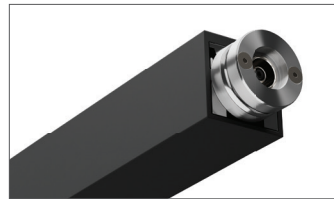

INSTALLATION

Easy and rapid installation with snap-in Connectors and Locking Allen screws

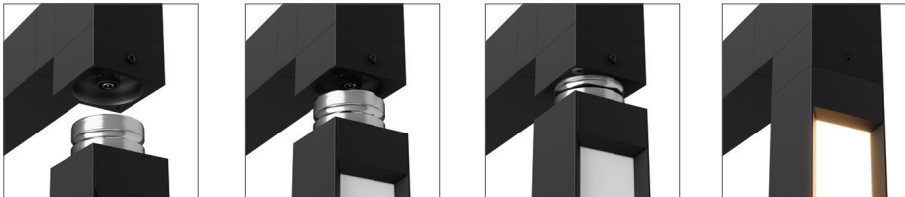

CONNECTIVITY

Flexible Connectors: I, L, T, X, Wall Mount and Corner Connectors (3-, 4-, 5-way)

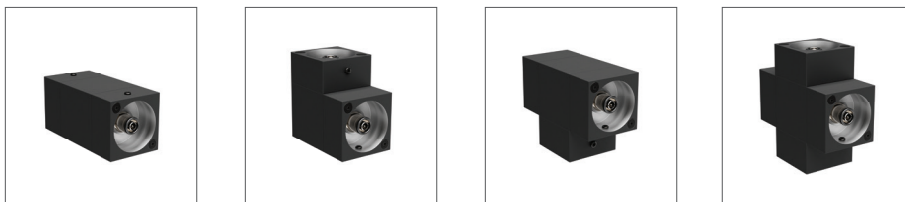

To view all Brox connectors, see p.17

MOUNTING AND POWER SOURCE

Ceiling-Mount or Remote Power Supply & Aircraft Cable Ceiling Suspension

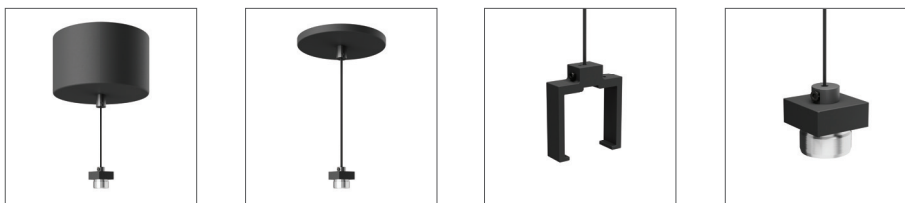

See p.17 for additional details and ordering grids



DESIGNING WITH BROX — ALL THE PARTS TO BUILD YOUR SYSTEM

Brox Bars are available in multiple lengths and rotate 360° to provide flexibility in design and accommodate direct or indirect lighting. Blank Bars allow the option to design without light, and a multitude of connectors are offered to build your design in three dimensions.

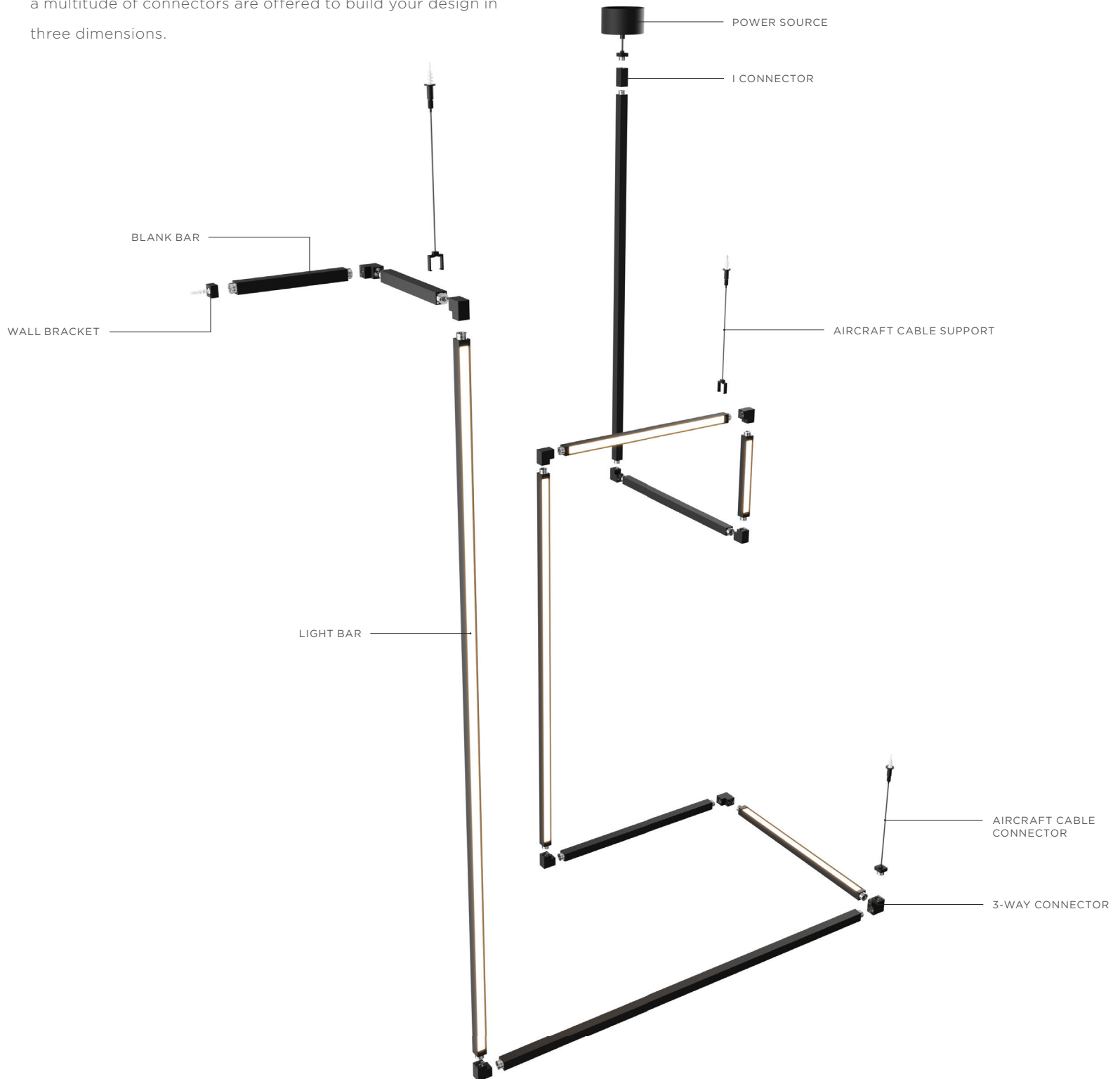



BUILDING YOUR BROX SYSTEM

Brox is an easy-to-install system with components that snap together and lock into place with simple Allen screws.

FOLLOW THESE GUIDELINES TO PLAN AND BUILD YOUR SYSTEM:

1. Continuous runs over 45 feet require an additional driver and isolated connector. For support, consult the Quotes Department by phone at 847.410.4666 or email quotes@techlighting.com
2. Configurations between 1-8 feet require a minimum of two suspension points. Larger systems require additional suspension support every eight feet.

General Support Rules:

- a. 1 Support at each top-plane, rail-to-rail connection point
- b. 1 Support for every 8 foot horizontal run (top-plan)
- c. 1 Support at the top-most rail every 16' of vertical run

Brox connectors allow you to design your system with multiple dimensions at any 90° angle.

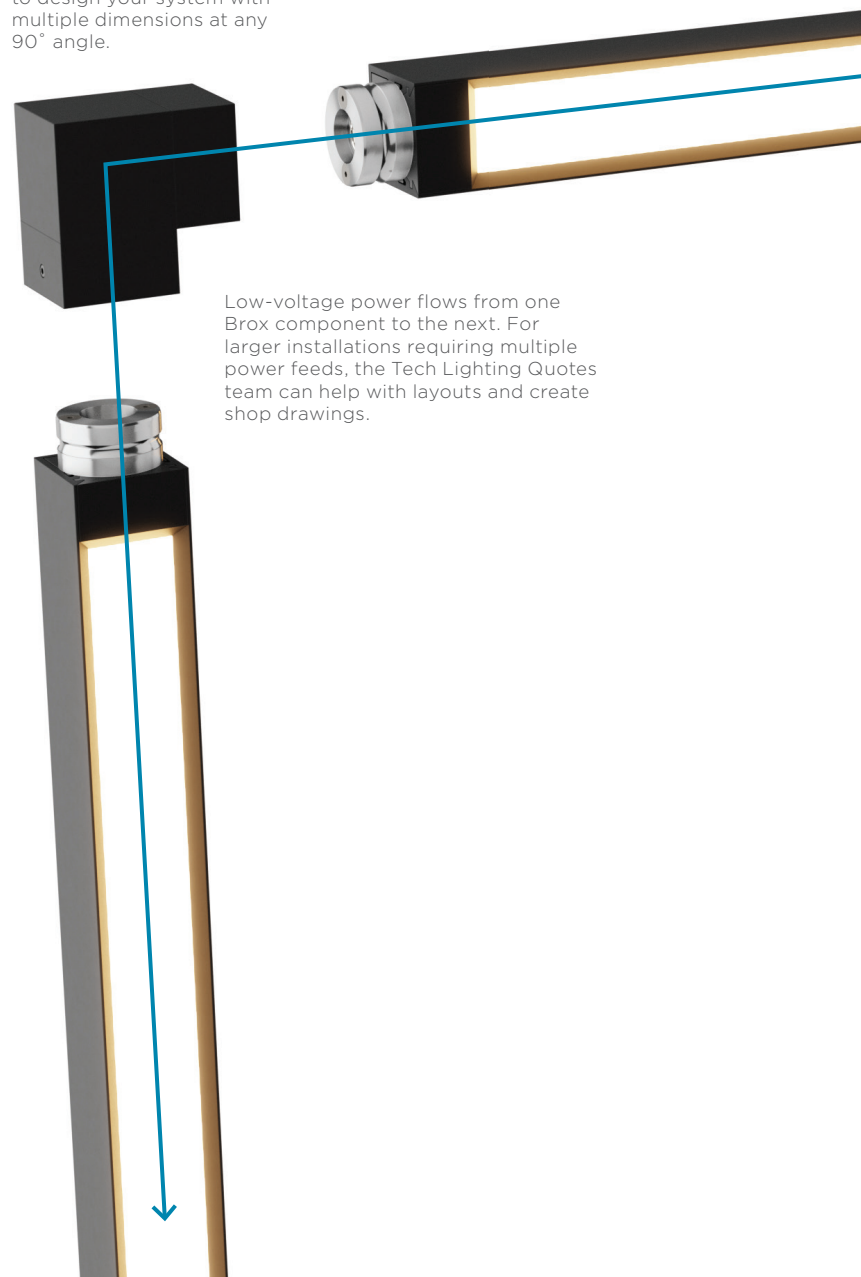

Low-voltage power flows from one Brox component to the next. For larger installations requiring multiple power feeds, the Tech Lighting Quotes team can help with layouts and create shop drawings.

Remote Driver



Surface Driver



Choose between two options to supply power to your Brox system - a minimal ceiling approach with the remote driver option or if access above your ceiling is limited the surface canopy option.

Use connectors to drop power to your system or link long runs together.

Supports at each corner maintain a secure and level system. If placed directly on the Light Bar, rotation is limited to every 90°.

Support can be mounted on the connector to allow for 360° rotation.

360°
ROTATION

Light Bars rotate 360° to aim light in your preferred direction.

Vertical and Horizontal Light Bars also available as Blank Bars.

Finish each run with an end cap.

Wall Connector provides design flexibility to mount light bars on wall or ceiling.





LIGHT BAR COMPONENTS &
PRE-CONFIGURED SYSTEMS





LIGHT BARS



SERIES	LENGTH (A)	CRI	COLOR TEMPERATURE	HARDWARE FINISH
700BRXLB	12 12 (9.9") 24 24 (21.9") 48 48 (45.9") 72 72 (69.9") 96 96 (93.9")	L9 90 CRI	30 3000K	B NIGHTSHADE BLACK

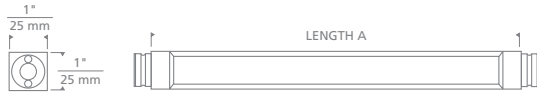

SPECIFICATIONS

DELIVERED LUMENS	100+ LUMENS PER FOOT
WATTS	2 WATTS PER FOOT
INPUT VOLTAGE/ DIMMING	SURFACE: 120V-277V ELV AND FORWARD PHASE REMOTE: 120V ELV AND FORWARD PHASE 120V-277V 0-10V
DIMMING	ELV; DIMS BELOW 3%
CCT	3000K
CRI	90 CRI
GENERAL LISTING	ETL
CALIFORNIA TITLE 24	This product can be used to comply with California Building Energy Efficiency Standards 2016 Title 24 Part 6.
FINISH	Nightshade Black
LED LIFETIME	L70; 70,000 Hours
WARRANTY*	5 Years

* Visit techlighting.com for specific warranty limitations and details.

BLANK BARS



SERIES	LENGTH (A)	HARDWARE FINISH
700BRXBB	12 12 (9.9") 24 24 (21.9") 48 48 (45.9") 72 72 (69.9") 96 96 (93.9")	B NIGHTSHADE BLACK



CONNECTORS



I CONNECTOR

700BRXIB

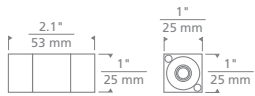

T CONNECTOR

700BRXTB

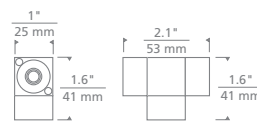

L CONNECTOR

700BRXLB

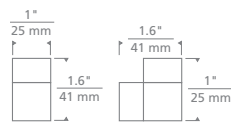

CORNER CONNECTOR

700BRXCB

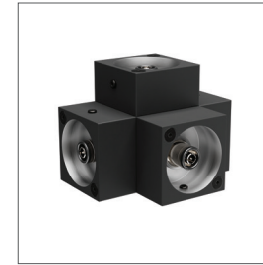
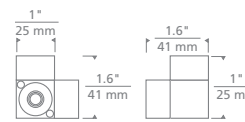

4-WAY CONNECTOR

700BRX4B

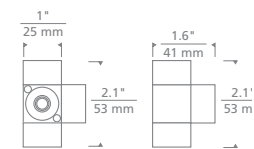

5-WAY CONNECTOR

700BRX5B

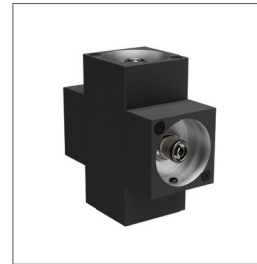
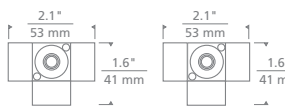

X CONNECTOR

700BRXXB

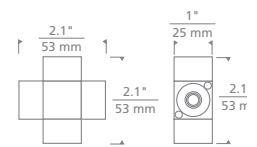

END CAP

700BRXENDB

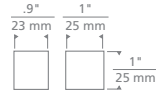

MOUNTING



WALL CONNECTOR

700BRXWB

Ships with wall anchors.
May be used in ceiling.

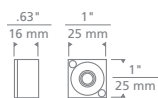

AIRCRAFT CABLE SUPPORT

700BRXCBLB

Clip on connectors or bars to provide support anywhere along the run.

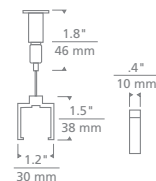

AIRCRAFT CONNECTOR

700BRXCBLCB

Mounts to any connector to provide additional support.

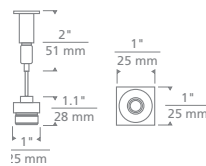

POWER



SURFACE DRIVER AND CANOPY

700BRXSRT100B-ELV (120V-277V ELECTRONIC)
Includes 100 Watt electronic driver (120V-277V input | 24V DC output).

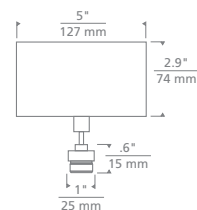

REMOTE DRIVER AND CANOPY

700BRXRT100B-ELV (120V ELECTRONIC)
700BRXRT100B-010 (120V-277V 0-10V)
Includes 100 Watt electronic driver (120V input | 24V DC output) or 100 watt 0-10V driver (120V-277V input | 24V DC output).

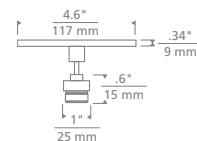

PRE-CONFIGURED SYSTEMS

Pre-configured 12" Square, 24" Square and 48" Rectangle systems can be used as stand-alone fixtures or can be interlinked as floating cubes to add depth to room decor and architecture.

12" SQUARE

700BRXCL93012BR (REMOTE) | 700BRXCL93012BS (SURFACE DRIVER)

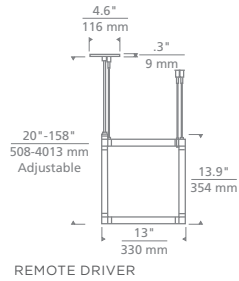

REMOTE DRIVER

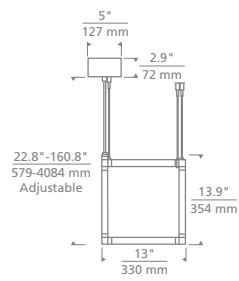

SURFACE DRIVER

24" SQUARE

700BRXCL93024BR (REMOTE DRIVER) | 700BRXCL93024BS (SURFACE DRIVER)

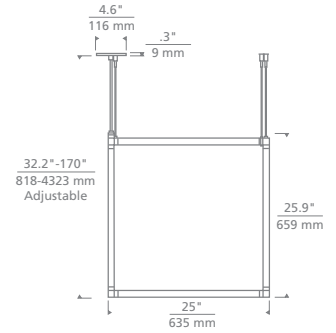

REMOTE DRIVER

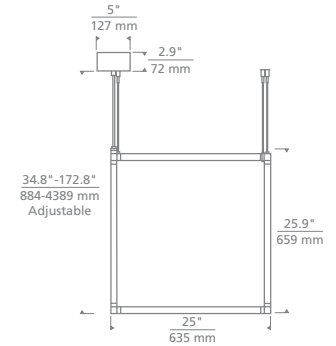

SURFACE DRIVER

48" RECTANGLE

700BRXRL93048BR (REMOTE DRIVER) | 700BRXRL93048BS (SURFACE DRIVER)

NOTE: MAY BE INSTALLED HORIZONTALLY OR VERTICALLY

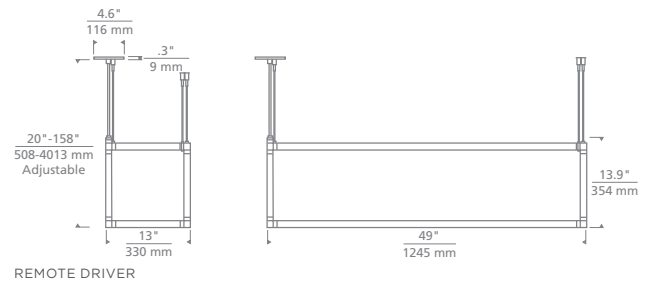

REMOTE DRIVER

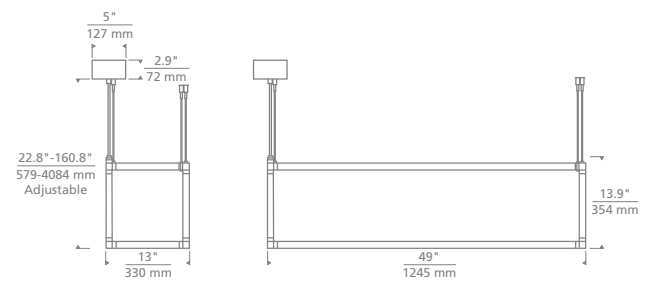

SURFACE DRIVER





7400 Linder Ave.
Skokie, IL 60077

T 847 410 4400
F 847 410 4500
W techlighting.com

VISUAL COMFORT & CO.

921TLBROX20